

CATALOG



Pass & Seymour®
ELECTRICAL WIRING DEVICES

2017
2018

designed to be better.™



A catalog for all your wiring device needs.

The Pass & Seymour® Wiring Devices and Accessories Product Guide is packed with useful information. This helpful guide works for you, whether you're a purchasing agent, distributor salesperson, electrician, or specifying engineer – as you strive to choose the best product for the job at hand.

STRAIGHT BLADE RECEPTACLES
Tamper-Resistant Specification Grade Receptacles 15 & 20A, 125V

TR621

Features

- Thermoplastic dual mechanism shutter system to help prevent insertion of foreign objects.
- Exclusive patented feature, circuit label on face allows permanent circuit identification.
- Extra heavy-duty brass, one-piece mounting strap with integral ground.
- One-piece, brass, triple-wide power contacts for lasting retention.
- Strap tabs wrap around and lock down on face to prevent strap from separating from face and back body.
- Impact-resistant nylon face and back body.
- Easily accessed break-off, line-contact connecting tab for fast, easy split-circuit wiring.
- Two drive screws anchor strap to back body and face.
- Exclusive patented feature, external screw-pressure-plate back wire clamp on ground terminal for faster, easier installation.
- External screw-pressure-plate back wire clamp with #10 brass terminal screws for visual assurance of a good connection.
- Auto-ground clip assures positive ground.

CATALOG NUMBER	RATING		COLOR	NEMA CONFIG. NO.	3rd PARTY COMPLIANCE		
	A	V.			UL98	PSGL WCS96	C22.2 No. 42
DUPLEX RECEPTACLES BACK & SIDE WIRE							
TR621	15	125	Ivory	5-15R	*	*	*
TR62W	15	125	White	5-15R	*	*	*
TR62B	15	125	Brown	5-15R	*	*	*
TR62G	15	125	Gray	5-15R	*	*	*
TR62BK	15	125	Black	5-15R	*	*	*
TR62RD	15	125	Red	5-15R	*	*	*
TR62LA	15	125	Light Almond	5-15R	*	*	*
TR62BL	15	125	Blue	5-15R	*	*	*
TR62H	20	125	Ivory	5-20R	*	*	*
TR62W	20	125	White	5-20R	*	*	*
TR62B	20	125	Brown	5-20R	*	*	*
TR62G	20	125	Gray	5-20R	*	*	*
TR62BK	20	125	Black	5-20R	*	*	*
TR62RD	20	125	Red	5-20R	*	*	*
TR62LA	20	125	Light Almond	5-20R	*	*	*

The Mechanical Shutter System

Thermoplastic shutter in closed position covers access to contacts.

Insertion of object in any one side does not open shutter.

Two-bladed plug or grounding plug compresses spring and automatically opens both shutters.

2 Pole, 3 Wire

NEMA 5-15R NEMA 5-20R

NEC® section 517.18(C) Pediatric Locations.
Receptacles located within the rooms, bathrooms, playrooms, activity rooms, and patient care areas of pediatric wards shall be listed under tamper resistant or employ a listed tamper resistant cover.

For Bulk Packaging Solutions consult factory.

WWW.LEGRAND.US

- Color-coded section pages** help you find products fast. Plus, product and section headings on every page.
- Clear, sans-serif typefaces** remain legible after scanning and photocopying.
- Product Features** tell how our products work for you — fast!
- Dimensions overlay photos and line art.** No need to look in three different spots to get a “full picture” of the product.
- Key information at a glance:**
 - Features/Specifications
 - Catalog numbers
 - Canadian models
 - 3rd Party listings
 - NEMA ratings/configurations
 - Amperage/Voltage
 - Dimensions
 - Application notes

- Silhouetted product photos** suitable for scanning and photocopying.
- NEMA configurations in 3 locations!** At beginning of catalog, in appropriate sections, and on pages with NEMA-applicable products.
- Additional information or accessory listing** for added convenience.
- Catalog numbers below product photos and line drawings** let you identify what you want by sight.
- NEC® requirements** called out near products help you keep current.



Energy-saving products will display an energy logo indicating the product reduces environmental impact and helps control energy costs.

Portions of this document are reprinted with permission from NFPA 70-1999, the National Electrical Code®, Copyright® 2013, National Fire Protection Association, Quincy, MA 02269. This reprinted material is not the complete and official position of the National Fire Protection Association, on the referenced subject which is represented only by the standard in its entirety. National Electrical Code® and NEC® are registered trademarks of the National Fire Protection Association, Inc., Quincy, MA 02269.

To make your job easier, Legrand has gone to great lengths to ensure the accuracy of this catalog's data and graphics. Should you discover errors, please report them to us; we will gladly correct future editions.

The data and dimensions listed in the following pages are accurate as of the publishing date. Legrand reserves the right to change the design, dimensions, materials and manufacturing techniques of the products listed without notice. Therefore, you are encouraged to verify these characteristics before specifying, ordering or installing these products.



SWITCHES

A



STRAIGHT BLADE RECEPTACLES

B



GFCIs

C



AFCIs

D



HOSPITAL GRADE DEVICES

E



SURGE PROTECTIVE & ISOLATED GROUND DEVICES

F



STRAIGHT BLADE PLUGS & CONNECTORS

G



INDUSTRIAL SPEC GRADE TURNLOK® LOCKING DEVICES

H



CAM-TYPE DEVICES

I



IEC 309 INDUSTRIAL PRODUCTS

J



FLEXCOR® WIRE MESH GRIPS

K



RUBBER & WATERTIGHT DEVICES

L



SWITCH DISCONNECTS & MANUAL MOTOR CONTROLLERS

M



OCCUPANCY & VACANCY SENSORS & TIMERS

N



DIMMERS & FAN SPEED CONTROLS

O



SLATER® PLASTIC BOXES

P



REIKER® CEILING FAN & FIXTURE SUPPORT PRODUCTS

Q



WEATHERPROOF BOXES & COVERS

R



WALL PLATES & SPECIALTIES

S



ELECTRICAL ACCESSORIES

T

REFERENCE

After Table of Contents

Featured New Products

Sustainability

Technical Specifications **Section U**

Glossary **Section V**

Index **Section W**

Innovative solutions that transform your living spaces.



USB Charging Devices

See Section B.



The most complete line of GFCIs

See Section C.



Pass & Seymour Tamper-Resistant Night Light Combinations include either a standard or GFCI receptacle. Add both safety and convenience!

See Sections B, C.

PASS & SEYMOUR® RESIDENTIAL SOLUTIONS



LIGHTING CONTROLS

When you're looking for quality energy-saving solutions, you'll find them in the broad line of Wattstopper® Lighting Controls. That includes many stylish dimmer and fan-speed control choices, vacancy and occupancy sensors, and timers.

See Sections N, O.



Wattstopper Occupancy and Vacancy Sensors add safety, convenience and energy savings.

See Section N.

Everyone wants a home that's a step above the ordinary. Now the radiant® collection of switches, outlets, dimmers, screwless wall plates, and home automation controls puts that stylish finishing touch affordably within reach. radiant gets rid of unsightly screws, delivering clean looks in a range of colors and metallic finishes. Put more modern convenience at your fingertips with these devices from the radiant collection:

- AFCI and AFCI/GFCI Receptacles
- USB Charging Devices
- Tru-Universal Dimmers
- Digital Timers
- Vacancy and Occupancy Sensors
- Night Light and Switch Combination Devices
- Tamper-Resistant Receptacles
- Self-Test GFCIs with SafeLock® Protection
- Screwless Wall Plates
- Multi-location Dimmers
- Metallic-Finish Wiring Devices and Wall Plates

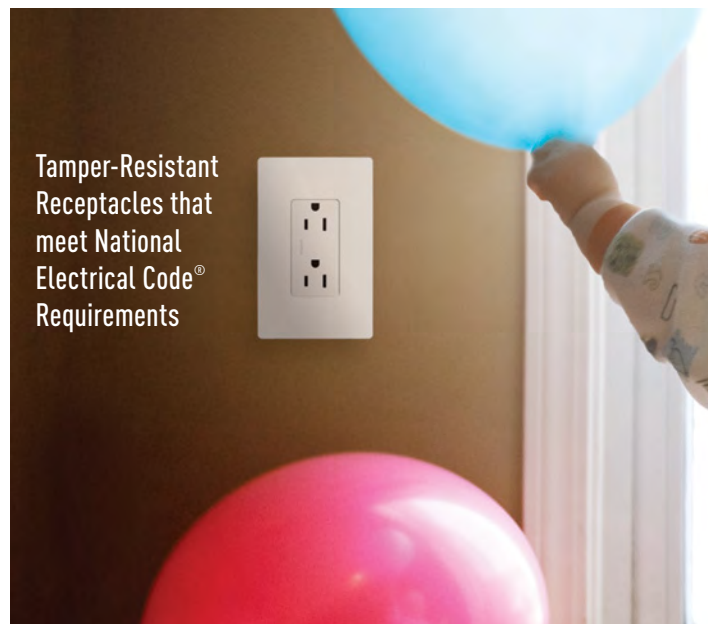

Tamper-Resistant Receptacles that meet National Electrical Code® Requirements

Pass & Seymour Tamper-Resistant Receptacles feature an automatic shutter system to prevent kids from inserting objects. Our complete line covers all applications.

See Section B.

Innovative solutions that increase productivity and safety.



Subtract waste and add productivity with Pass & Seymour bulk solutions.
Consult factory.

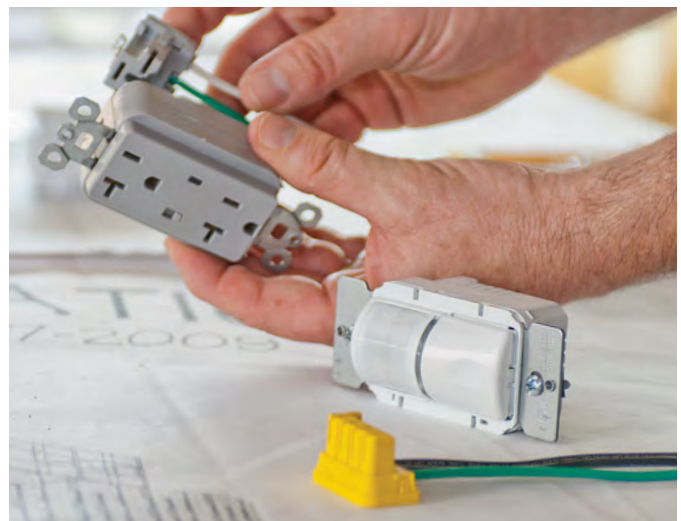

P&S PlugTail® Wiring Devices — the fastest, most reliable wiring device installation for any commercial job.
See Sections A, B.

PASS & SEYMOUR® COMMERCIAL PRODUCTS



Plug Load Controls
See Section B.

Pass & Seymour Commercial devices are known for quality and reliability. With good reason, too. Easy to install and hard to break, they're the smart choice for every commercial install.

- PlugTail® Wiring Devices
- Specification Grade Switches
- Fed Spec and Hospital Grade USB Charging Devices
- Self-Test GFCIs with SafeLock® Protection
- Occupancy and Vacancy Sensors
- Surge Protective and Isolated Ground Devices
- Plug Load Controls and Receptacles
- Hospital Grade Devices
- Straight Blade Plugs & Connectors
- Clamp-Lock® Plugs & Connectors
- Titan® Dimmers
- Specification Grade Receptacles
- Fan Speed Controls
- Wall Plates



Hospital Grade Devices — solutions for every healthcare application.
See Section E.



Power-Indicator Receptacles are perfect for emergency-circuit applications.
See Section B or D.

Innovative solutions that stand up to harsh environments.



Turnlok® Locking Plugs & Connectors
See Section H.



Flexcor® Wire Mesh Grips
See Section K.



SteriGuard™ Antimicrobial Devices
See Section L.

PASS & SEYMOUR® INDUSTRIAL DEVICES



When we offered the first fusible mechanical interlock with visible blown-fuse indication, we helped plants avoid downtime. That's typical of the feature-rich Pass & Seymour Industrial device line. These rugged, reliable workhorses can take all the wear and tear industrial facilities can dish out.

- Straight Blade Plugs, Connectors and Receptacles
- Turnlok® Plugs, Connectors, Receptacles, Flanged Inlets and Outlets
- Rubber Dust-tight and Watertight Plugs, Connectors, and Receptacles
- SteriGuard™ Antimicrobial Plugs, Connectors, and Cord Drops
- Portable Outlet Boxes
- Cam-Type Devices
- Flexcor® Wire Mesh Grips
- IEC Pin and Sleeve Devices
- Surge Protective and Isolated Ground Devices
- Industrial Grade Switches
- Manual Controllers
- Mechanical Interlocks
- Safety Switches
- Ground Continuity Monitoring (GCM) Plugs and Connectors



IEC 309 Industrial Products for maximum durability and minimum downtime.

See Section J.



Ground Continuity Monitoring Plugs and Connectors add job site safety.

See Sections G, H.

our commitment to sustainability

BETTER PERFORMANCE, BETTER OPERATIONS, BETTER SOLUTIONS

At Legrand, our sustainability commitment translates into greater benefits and tangible value for our customers, business partners, employees and the broader community.

BETTER PERFORMANCE.

Our sustainability goals reach inside and outside Legrand. We provide building solutions to meet many building performance goals from sustainability and energy efficiency to productivity and occupant well being.



BETTER OPERATIONS.

We focus on operational excellence because we believe optimizing the way we manage energy, water and waste is not only good for the environment, it's good for business. As part of the Department of Energy's Better Building, Better Plants Challenge (BBBP) Legrand has reduced its energy intensity by over 30 percent across 14 sites in the United States in just three years.



DESIGNED FOR YOU.

Legrand is committed to sharing key tools to reduce energy intensity. Read more about our journey and download no-cost tools and resources at www.legrand.us/sustainability.

SUSTAINABILITY



The FSC® certified paper used for the text pages of this catalog is made from 30% post-consumer recycled paper; the cover paper is made of 10% post-consumer recycled paper. Over 246,000 pounds of paper were used to produce this catalog. By substituting recycled paper for standard paper, the following savings were realized:

WOOD USE – Post consumer content means a savings of more than 104 tons of wood.

GREENHOUSE GASES – Eliminated more than 71,087 pounds of greenhouse gases.

WATER – Saved more than 317,000 gallons of wastewater.

SOLID WASTE – 24,000 less pounds of solid waste was generated.*

These savings would not have been possible without the assistance of:

Catalyst Paper Company – Manufacturer of Consoweb Gloss and other quality, certified and recycled printing papers.

LSC – Printer, reduced environmental impact by using the highest practical renewable content ink.

Lindenmeyr Munroe – A leading paper broker

*Source: Environmental Paper Network Online Paper Calculator. FSC® is not responsible for the savings calculations by using this paper.

SWITCHES



Featured Products	 <p>PLUGTAIL® SPEC GRADE SWITCHES</p> <p style="font-size: 2em; color: #00AEEF;">A-3</p>	 <p>RADIANT® COMBO SWITCHES</p> <p style="font-size: 2em; color: #00AEEF;">A-19</p>	 <p>MANUAL CONTROLLERS</p> <p style="font-size: 2em; color: #00AEEF;">A-24</p>
--------------------------	--	--	--

Horsepower Rating Chart	A-2	TradeMaster® Grounding Toggle Switches	A-12
PlugTail® Industrial Extra-Heavy Duty Spec Grade Switches	A-2	radiant® Switches	A-14
Industrial Extra Heavy-Duty Spec Grade Switches	A-4	Combination Switches	A-16
Lock Switch Replacement Keys	A-5	Spec Grade Paddle Combination Switches	A-18
Extra Heavy-Duty Spec Grade & Security Switches	A-6	radiant® Combination Switches	A-19
Hard Use & Commercial Spec Grade Switches	A-7	radiant® Combination Switch/ GFCI Tamper-Resistant Receptacles	A-22
PlugTail® Decorator Spec Grade Switches	A-8	Canopy Switches & Locator Switches	A-23
Decorator Specification Grade Switches	A-10	Shim-Lock	A-23
Momentary & Maintained Contact Switches	A-11	Manual Controllers	A-24

SWITCHES

PlugTail® Industrial Extra-Heavy Duty Spec Grade Toggle Switches

HP CONVERSION TABLE – SWITCHES

15 Amp	1/2 Horsepower at 120VAC; 2 Horsepower at 240VAC
20 Amp	1 Horsepower at 120VAC; 2 Horsepower at 240VAC
30 Amp	2 Horsepower at 120VAC; 2 Horsepower at 240VAC

Note: HP Conversions apply to all specification grade switches.

PT20AC1W

PlugTail® Specification Grade Toggle Switches

- A. Auto-ground clip** assures positive ground.
 - B. One-piece nickel-plated mounting strap** for superior corrosion resistance.
 - C. No exposed terminals** create a finger-safe application before, during and after installation.
 - D. Built-in connector** features large brass terminal blades to ensure consistent, reliable electrical connections.
 - E. Large brass contacts** snugly terminate on device blade terminals. Audible snapping latch assures connection, allows release.
 - F. Polycarbonate connector housing** secures terminations and conductors in a UL Listed, finger-safe housing.
 - G. Pre-stripped connector leads** fasten to conductors, easier than standard pigtails.
 - H. Glass-reinforced nylon back body** for durability and strength.
 - I. One-piece toggle** molded from chemical-, impact- and heat-resistant thermoplastic.
- Heavy-duty bumpers** for quiet, smooth operation.
Shallow design for easier installation.

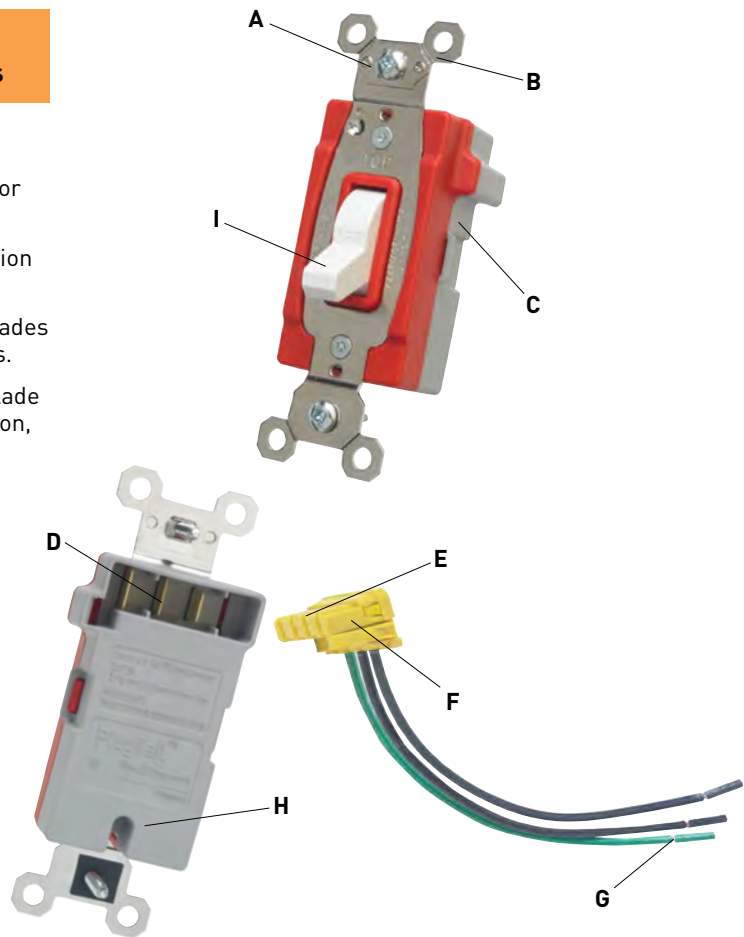

SWITCHES

PlugTail® Industrial Extra-Heavy Duty Spec Grade Switches 15 & 20A, 120/277VAC

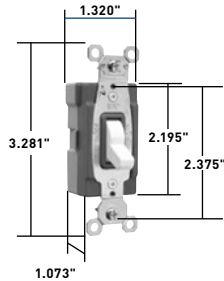

PT20AC1W



PTS6STR3

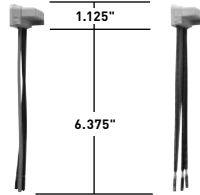

PTS6STR4

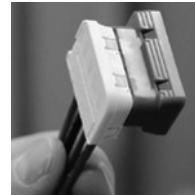

PTJ



CATALOG NUMBER		RATING		COLOR	3rd PARTY COMPLIANCE		
SINGLE POLE	THREE-WAY	A.	VAC			FSUL WS896	
TOGGLE SWITCHES							
PT15AC1W	PT15AC3W	15	120/277	White	•	•	•
PT15AC1	PT15AC3	15	120/277	Brown	•	•	•
PT15AC1BK	PT15AC3BK	15	120/277	Black	•	•	•
PT15AC1RED	PT15AC3RED	15	120/277	Red	•	•	•
PT15AC1LA	PT15AC3LA	15	120/277	Light Almond	•	•	•
PT20AC1I	PT20AC3I	20	120/277	Ivory	•	•	•
PT20AC1W	PT20AC3W	20	120/277	White	•	•	•
PT20AC1	PT20AC3	20	120/277	Brown	•	•	•
PT20AC1BK	PT20AC3BK	20	120/277	Black	•	•	•
PT20AC1GRY	PT20AC3GRY	20	120/277	Gray	•	•	•
PT20AC1RED	PT20AC3RED	20	120/277	Red	•	•	•
PT20AC1LA	PT20AC3LA	20	120/277	Light Almond	•	•	•
ILLUMINATED TOGGLE SWITCHES							
PT15AC1WSL	PT15AC3WSL	15	120/277	White	•	•	•
PT20AC1CSL	PT20AC3CSL	20	120/277	Clear	•	•	•
PT20AC1ISL	PT20AC3ISL	20	120/277	Ivory	•	•	•
PT20AC1WSL	PT20AC3WSL	20	120/277	White	•	•	•

CATALOG NUMBER	WIRE TYPE	WIRE LENGTH	WIRE COLORS
PLUGTAIL CONNECTORS FOR SINGLE POLE SWITCHES 120/277VAC			
PTS6STR3	3 Wire Stranded	6"	Green, Black, Black
PTS6SOL3	3 Wire Solid	6"	Green, Black, Black
PTS6STR3277	3 Wire Stranded	6"	Green, Brown, Brown
PTS6SOL3277	3 Wire Solid	6"	Green, Brown, Brown
PLUGTAIL CONNECTORS FOR THREE-WAY SWITCHES 120/277VAC			
PTS6STR4	4 Wire Stranded	6"	Green, Red, Red, Black
PTS6SOL4	4 Wire Solid	6"	Green, Red, Red, Black
PTS6STR4277	4 Wire Stranded	6"	Green, Brown, Yellow, Yellow
PTS6SOL4277	4 Wire Solid	6"	Green, Brown, Yellow, Yellow
PLUGTAIL CONNECTORS FOR SINGLE POLE SWITCHES WITH WAGO CONNECTORS			
PTS6STR3BP	3 Wire Stranded	6"	Green, Black, Black
PTS6SOL3BP	3 Wire Solid	6"	Green, Black, Black
PTS6STR3277BP	3 Wire Stranded	6"	Green, Brown, Brown
PLUGTAIL CONNECTORS FOR THREE-WAY SWITCHES WITH WAGO CONNECTORS			
PTS6STR4BP	4 Wire Stranded	6"	Green, Red, Red, Black
PTS6SOL4BP	4 Wire Solid	6"	Green, Red, Red, Black
PTS6STR4277BP	4 Wire Stranded	6"	Green, Brown, Yellow, Yellow

CATALOG NUMBER	DESCRIPTION
PLUGTAIL JUMPERS	
PTJ	PlugTail Cover for Rough In
PTJ5	PlugTail Cover for Rough In, 5-pack

All models made exclusively of chemical-, heat- and impact-resistant thermoplastics.

SWITCHES

Industrial Extra Heavy-Duty Specification Grade Switches

PS20AC1LA

Industrial EHD Specification Grade Switches

- A. One-piece nickel-plated steel strap** with integral ground.
 - B. Auto-ground clip** assures positive ground.
 - C. Shallow design** for easier installation.
 - D. Glass-reinforced nylon back body** for superior durability and strength.
 - E. Locking support** provides resistance to face and back body separation.
 - F. Side and external screw-pressure-plate back wire** with #14 – #10 AWG copper or copper-clad wire.
 - G. Grounding terminal** is standard with screw-pressure-plate back wire.
 - H. One-piece toggle** molded from chemical-, impact- and heat-resistant thermoplastic.
- Cam control and spring actuator** for positive “makes and breaks.”
- Heavy-duty, brass alloy, one-piece contact arm** virtually eliminates contact bounce
- Oversized silver alloy contacts** for long life and better heat dissipation.
- Heavy-duty bumpers** for quiet, smooth operation.

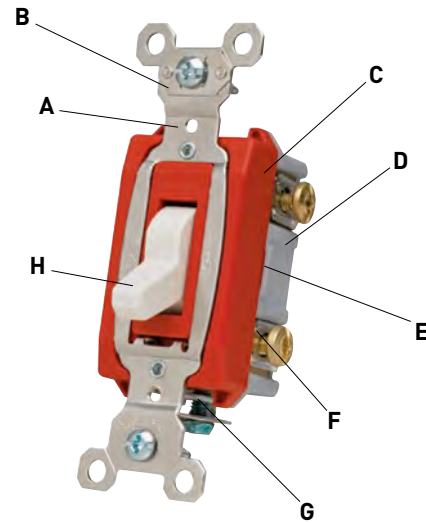

PS20AC1LA

SWITCHES

Industrial Extra Heavy-Duty Specification Grade Switches 15, 20 & 30A, 120, 277 & 120/277VAC

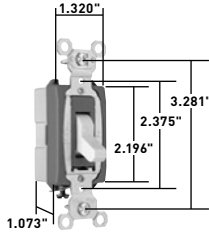

15 & 20 Amp*

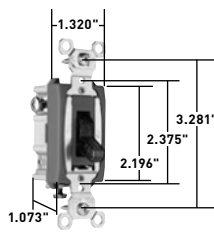

15 & 20 Amp Lighted & Pilot Lighted*

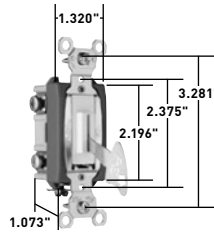

Locking*
*30AC series is 1.437" wide



12
Fits current Switches



1498
Fits Switches manufactured before 1976



1498-NT
Fits Switches manufactured 1976-1982

Lock Switch Replacement Keys
(One key furnished with each switch)

Features

- Heavy-gauge one-piece copper alloy contact arm virtually eliminates contact bounce.
- Cam controls fast "make" and positive "break" to minimize arcing.
- Heavy-duty bumper pads for quiet operation.
- Back body made of glass-reinforced nylon.
- Locking support provides resistance to face and back body separation.
- Oversized silver alloy contacts for long life and better heat dissipation.
- Grounding terminal is standard.
- Shallow design for ease of installation.
- Nickel-plated steel strap with integral ground.
- Auto-ground clip assures positive ground.
- One-piece toggle molded from chemical-, impact- and heat-resistant thermoplastic.

CATALOG NUMBER				RATING			3rd PARTY COMPLIANCE		
SINGLE POLE	DOUBLE POLE	THREE-WAY	FOUR-WAY	A.	VAC	COLOR	UL20	FSUL WS896	C22.2 111
TOGGLE SWITCHES BACK & SIDE WIRE									
PS15AC1I	PS15AC2I	PS15AC3I	PS15AC4I	15	120/277	Ivory	•	•	•
PS15AC1W	PS15AC2W	PS15AC3W	PS15AC4W	15	120/277	White	•	•	•
PS15AC1	PS15AC2	PS15AC3	PS15AC4	15	120/277	Brown	•	•	•
PS15AC1GRY	PS15AC2GRY	PS15AC3GRY	PS15AC4GRY	15	120/277	Gray	•	•	•
PS15AC1LA	PS15AC2LA	PS15AC3LA	PS15AC4LA	15	120/277	Light Almond	•	•	•
PS20AC1I	PS20AC2I	PS20AC3I	PS20AC4I	20	120/277	Ivory	•	•	•
PS20AC1W	PS20AC2W	PS20AC3W	PS20AC4W	20	120/277	White	•	•	•
PS20AC1	PS20AC2	PS20AC3	PS20AC4	20	120/277	Brown	•	•	•
PS20AC1GRY	PS20AC2GRY	PS20AC3GRY	PS20AC4GRY	20	120/277	Gray	•	•	•
PS20AC1BK	PS20AC2BK	PS20AC3BK	PS20AC4BK	20	120/277	Black	•	•	•
PS20AC1GN		PS20AC3GN		20	120/277	Green	•	•	•
PS20AC1RED	PS20AC2RED	PS20AC3RED	PS20AC4RED	20	120/277	Red	•	•	•
PS20AC1LA	PS20AC2LA	PS20AC3LA	PS20AC4LA	20	120/277	Light Almond	•	•	•
PS30AC1I	PS30AC2I	PS30AC3I		30	120/277	Ivory	•	•	•
PS30AC1W	PS30AC2W			30	120/277	White	•	•	•
PS30AC1	PS30AC2	PS30AC3		30	120/277	Brown	•	•	•
LIGHTED TOGGLE SWITCHES (LIGHTED WHEN OFF) BACK & SIDE WIRE									
PS15AC1CSL		PS15AC3CSL		15	120/277	Clear	•	•	•
PS15AC1ISL		PS15AC3ISL		15	120/277	Ivory	•	•	•
PS15AC1WSL		PS15AC3WSL		15	120/277	White	•	•	•
PS20AC1CSL		PS20AC3CSL		20	120/277	Clear	•	•	•
PS20AC1ISL		PS20AC3ISL		20	120/277	Ivory	•	•	•
PS20AC1WSL		PS20AC3WSL		20	120/277	White	•	•	•
PS20AC1LASL		PS20AC3LASL		20	120/277	Light Almond	•	•	•
PILOT LIGHTED SWITCHES (LIGHTED WHEN ON) BACK & SIDE WIRE									
PS15AC1CPL		PS15AC3CPL		15	120	Clear	•	•	•
PS15AC1RPL		PS15AC3RPL		15	120	Red	•	•	•
PS20AC1CPL		PS20AC3CPL		20	120	Clear	•	•	•
PS20AC1CPL7				20	277	Clear	•	•	•
PS20AC1RPL		PS20AC3RPL		20	120	Red	•	•	•
PS20AC1RPL7		PS20AC3RPL7		20	277	Red	•	•	•
	PS20AC2CPL			20	120/277	Clear	•	•	•
	PS20AC2RPL			20	120/277	Red	•	•	•
PS30AC1RPL		PS30AC3RPL		30	120	Red	•	•	•
	PS30AC2RPL			30	120/277	Red	•	•	•
LOCK SWITCHES (KEY CAN BE REMOVED IN BOTH POSITIONS) BACK & SIDE WIRE									
PS15AC1L		PS15AC3L		15	120/277	Gray	•	•	•
PS20AC1IL	PS20AC2IL	PS20AC3IL	PS20AC4IL	20	120/277	Ivory	•	•	•
PS20AC1WL	PS20AC2WL	PS20AC3WL	PS20AC4WL	20	120/277	White	•	•	•
PS20AC1L	PS20AC2L	PS20AC3L		20	120/277	Gray	•	•	•
PS20AC1REDL		PS20AC3REDL	PS20AC4REDL	20	120/277	Red	•	•	•
PS20AC1LAL	PS20AC2LAL	PS20AC3LAL	PS20AC4LAL	20	120/277	Light Almond	•	•	•
SECURITY SWITCHES BACK & SIDE WIRE									
PS20AC1KL	PS20AC2KL	PS20AC3KL	PS20AC4KL	20	120/277		•	•	•

For Bulk Packaging Solutions consult factory.

All devices listed on this page conform to NEMA WD-1 and WD-6.

SWITCHES

Industrial Extra Heavy-Duty Specification Grade & Security Switches

15 & 20A, 347VAC; 20A, 120/277VAC

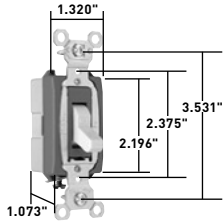

15 & 20 Amp

Canadian 347VAC

Features

- External screw-pressure-plate back and side wired. Accepts #14 – #10 AWG copper or copper-clad conductors.
- Heavy-gauge one-piece copper alloy contact arm virtually eliminates contact bounce.
- Cam controls fast “make” and positive “break” to minimize arcing.
- Heavy-duty bumper pads for quiet operation.
- High strength thermoplastic polycarbonate toggle.
- Back body made of glass-reinforced nylon.
- Locking support provides resistance to face and back body separation.
- Oversized silver alloy contacts for long life and better heat dissipation.
- Grounding terminal is standard.
- Shallow design for ease of installation.
- Nickel-plated steel strap with integral ground.
- Auto-ground clip assures positive ground.

CATALOG NUMBER		RATING		COLOR	3rd PARTY COMPLIANCE
SINGLE POLE	THREE-WAY	A.	VAC		C22.2 111
347VAC TOGGLE SWITCHES BACK & SIDE WIRE					
PS371510I	PS371530I	15	347	Ivory	•
PS371510W	PS371530W	15	347	White	•
PS371510	PS371530	15	347	Brown	•
PS371510GRY	PS371530GRY	15	347	Gray	•
PS371510BK	PS371530BK	15	347	Black	•
PS371510RED	PS371530RED	15	347	Red	•
PS372010I	PS372030I	20	347	Ivory	•
PS372010W	PS372030W	20	347	White	•
PS372010	PS372030	20	347	Brown	•
PS372010GRY	PS372030GRY	20	347	Gray	•
PS372010BK		20	347	Black	•
PS372010RED	PS372030RED	20	347	Red	•
PS372010LA	PS372030LA	20	347	Light Almond	•
PS372010L	PS372030L	20	347	Gray, Locking	•

Features

- Back and side wired. Accepts #14 – #10 AWG.
- Operated by cam lock for maximum security in critical areas.
- Recommended for tamper-proof installation in schools, public housing, trailer parks, freight yards, etc.
- Uses same key as Cat. #4600 cast enclosure.
- Key can be removed in both positions.

CATALOG NUMBER				RATING		3rd PARTY COMPLIANCE		
SINGLE POLE	DOUBLE POLE	THREE-WAY	FOUR-WAY	A.	VAC	UL20	FSUL WS896	C22.255
SECURITY SWITCHES BACK & SIDE WIRE								
PS372010KL				20	347	•		•

Denotes Canadian catalog number. All Canadian products have Combination Slotted/Robertson Head Brass Screws.

Stainless Steel Plate for PS20ACKL Switches Single Gang – SS717, Double Gang – SS727.

For custom combinations specify opening Style No. 302.

Catalog Number 4609 Security Switch Replacement Keys for PS20ACKL Switches (2 keys furnished with each switch).

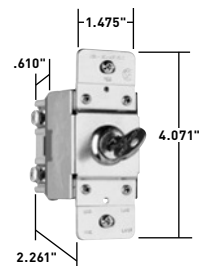

Security Switch

SWITCHES

Hard Use & Commercial Specification Grade Switches 15 & 20A, 120/277VAC

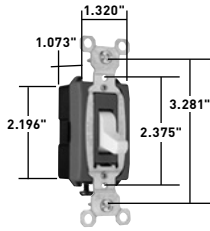

15 & 20 Amp

Features

- One-piece brass alloy contact arm for reliable electrical performance.
- One-piece steel strap with integral ground is plated for corrosion resistance.
- High strength thermoplastic polycarbonate toggle resists breaking and chipping under heavy abuse.
- Heavy-duty toggle bumpers for smooth and quiet operation.
- Back body made of glass-reinforced nylon.
- Locking support provides resistance to face and back body separation.
- Available with side wire or external screw-pressure-plate back and side wire models capable of accepting #14 – #10 AWG copper or copper-clad wire.
- Cam designed for fast make with positive break action to minimize arcing and prolong switch life.
- Oversized silver alloy contacts for longer dependable switch life.
- Tri-drive terminal and mounting screws.
- Auto-ground clip assures positive ground.

CATALOG NUMBER				RATING		COLOR	3rd PARTY COMPLIANCE		
SINGLE POLE	DOUBLE POLE	THREE-WAY	FOUR-WAY	A.	VAC		UL20	FSUL WS896	C22.2 111
HARD USE SPECIFICATION GRADE BACK & SIDE WIRE									
CSB15AC1I	CSB15AC2I	CSB15AC3I	CSB15AC4I	15	120/277	Ivory	•	•	•
CSB15AC1W	CSB15AC2W	CSB15AC3W	CSB15AC4W	15	120/277	White	•	•	•
CSB15AC1	CSB15AC2	CSB15AC3	CSB15AC4	15	120/277	Brown	•	•	•
CSB15AC1GRY	CSB15AC2GRY	CSB15AC3GRY	CSB15AC4GRY	15	120/277	Gray	•	•	•
CSB15AC1LA	CSB15AC2LA	CSB15AC3LA	CSB15AC4LA	15	120/277	Light Almond	•	•	•
CSB20AC1I	CSB20AC2I	CSB20AC3I	CSB20AC4I	20	120/277	Ivory	•	•	•
CSB20AC1W	CSB20AC2W	CSB20AC3W	CSB20AC4W	20	120/277	White	•	•	•
CSB20AC1	CSB20AC2	CSB20AC3	CSB20AC4	20	120/277	Brown	•	•	•
CSB20AC1BK		CSB20AC3BK		20	120/277	Black	•	•	•
CSB20AC1GRY	CSB20AC2GRY	CSB20AC3GRY	CSB20AC4GRY	20	120/277	Gray	•	•	•
CSB20AC1LA	CSB20AC2LA	CSB20AC3LA	CSB20AC4LA	20	120/277	Light Almond	•	•	•

CATALOG NUMBER		RATING		COLOR	3rd PARTY COMPLIANCE		
SINGLE POLE	THREE-WAY	A.	VAC		UL20	FSUL WS896	C22.2 111
COMMERCIAL SPECIFICATION GRADE SIDE WIRE							
CS15AC1I	CS15AC3I	15	120/277	Ivory	•	•	•
CS15AC1W	CS15AC3W	15	120/277	White	•	•	•
CS15AC1	CS15AC3	15	120/277	Brown	•	•	•
CS15AC1GRY	CS15AC3GRY	15	120/277	Gray	•	•	•
CS15AC1BK	CS15AC3BK	15	120/277	Black	•	•	•
CS15AC1LA	CS15AC3LA	15	120/277	Light Almond	•	•	•
CS20AC1I	CS20AC3I	20	120/277	Ivory	•	•	•
CS20AC1W	CS20AC3W	20	120/277	White	•	•	•
CS20AC1	CS20AC3	20	120/277	Brown	•	•	•
CS20AC1GRY	CS20AC3GRY	20	120/277	Gray	•	•	•
CS20AC1LA	CS20AC3LA	20	120/277	Light Almond	•	•	•

For Bulk Packaging Solutions consult factory.

SWITCHES

PlugTail® Decorator Specification Grade Switches

PT2626W PlugTail® Switches

- A. Auto-ground clip** assures positive ground.
 - B. Heavy-gauge steel strap** for superior strength.
 - C. No exposed terminals** create a finger-safe application before, during, and after installation.
 - D. Built-in connector** features large brass terminal blades to ensure consistent, reliable electrical connections.
 - E. Large brass contacts** snugly terminate on device blade terminals. Audible snapping latch assures connection, allows release.
 - F. Polycarbonate connector housing** secures terminations and conductors in a UL Listed, finger-safe housing.
 - G. WAGO push-in connectors** are available to further speed up installation.
- Shallow design** for easier installation.

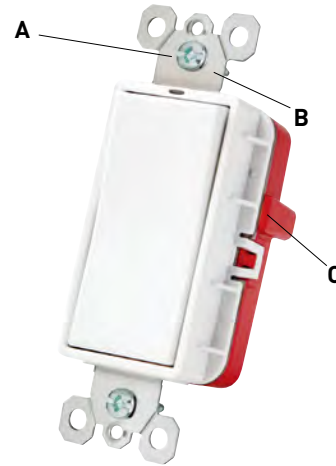

PT2626W

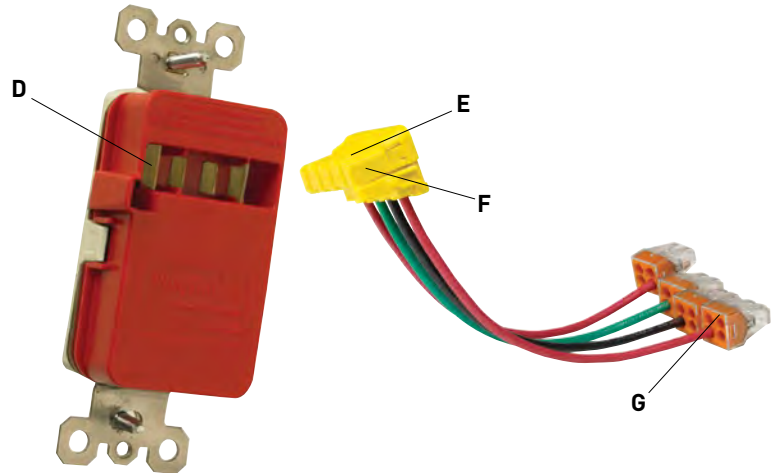

SWITCHES

PlugTail® Specification Grade Switches 15 & 20A, 120/277VAC

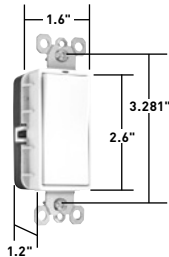

PT2621W

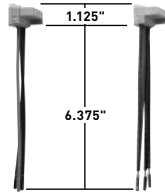

PTS6STR3 PTS6STR4

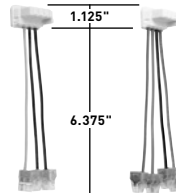

PTS6STR3BP PTS6STR4BP

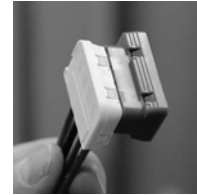

PTJ

CATALOG NUMBER		RATING		COLOR	3rd PARTY COMPLIANCE		
SINGLE POLE	THREE-WAY	A.	VAC		UL20	FSUL WS896	CSA C22.2 111
PADDLE SWITCHES							
PT2601I	PT2603I	15	120/277	Ivory	•	•	•
PT2601W	PT2603W	15	120/277	White	•	•	•
PT2601	PT2603	15	120/277	Brown	•	•	•
PT2601GRY	PT2603GRY	15	120/277	Gray	•	•	•
PT2601BK	PT2603BK	15	120/277	Black	•	•	•
PT2601LA	PT2603LA	15	120/277	Light Almond	•	•	•
PT2621I	PT2623I	20	120/277	Ivory	•	•	•
PT2621W	PT2623W	20	120/277	White	•	•	•
PT2621	PT2623	20	120/277	Brown	•	•	•
PT2621GRY	PT2623GRY	20	120/277	Gray	•	•	•
PT2621RED	PT2623RED	20	120/277	Red	•	•	•
PT2621BK	PT2623BK	20	120/277	Black	•	•	•
PT2621LA	PT2623LA	20	120/277	Light Almond	•	•	•
ILLUMINATED PADDLE SWITCHES							
PT2625I	PT2626I	20	120/277	Ivory	•	•	•
PT2625W	PT2626W	20	120/277	White	•	•	•

CATALOG NUMBER	WIRE TYPE	WIRE LENGTH	WIRE COLORS
PLUGTAIL CONNECTORS FOR SINGLE POLE SWITCHES			
PTS6STR3	3 Wire Stranded	6"	Green, Black, Black
PTS6SOL3	3 Wire Solid	6"	Green, Black, Black
PTS6STR3277	3 Wire Stranded	6"	Green, Brown, Brown
PTS6SOL3277	3 Wire Solid	6"	Green, Brown, Brown
PLUGTAIL CONNECTORS FOR THREE-WAY SWITCHES			
PTS6STR4	4 Wire Stranded	6"	Green, Red, Red, Black
PTS6SOL4	4 Wire Solid	6"	Green, Red, Red, Black
PTS6STR4277	4 Wire Stranded	6"	Green, Brown, Yellow, Yellow
PTS6SOL4277	4 Wire Solid	6"	Green, Brown, Yellow, Yellow
PLUGTAIL CONNECTORS FOR SINGLE POLE SWITCHES WITH WAGO CONNECTORS			
PTS6STR3BP	3 Wire Stranded	6"	Green, Black, Black
PTS6SOL3BP	3 Wire Solid	6"	Green, Black, Black
PTS6STR3277BP	3 Wire Stranded	6"	Green, Brown, Brown
PLUGTAIL CONNECTORS FOR THREE-WAY SWITCHES WITH WAGO CONNECTORS			
PTS6STR4BP	4 Wire Stranded	6"	Green, Red, Red, Black
PTS6SOL4BP	4 Wire Solid	6"	Green, Red, Red, Black
PTS6STR4277BP	4 Wire Stranded	6"	Green, Brown, Yellow, Yellow
PTS6SOL4277BP	4 Wire Solid	6"	Green, Brown, Yellow, Yellow

All PTS Connectors are 120/277VAC

CATALOG NUMBER	DESCRIPTION
PLUGTAIL JUMPER	
PTJ	PlugTail Cover for Rough In
PTJ5	PlugTail Cover for Rough In, 5-pack

All devices listed on this page conform to NEMA WD-1 and WD-6.

SWITCHES

Decorator Specification Grade Paddle Switches 15 & 20A, 120/277 & 347VAC; 20A, 120VAC

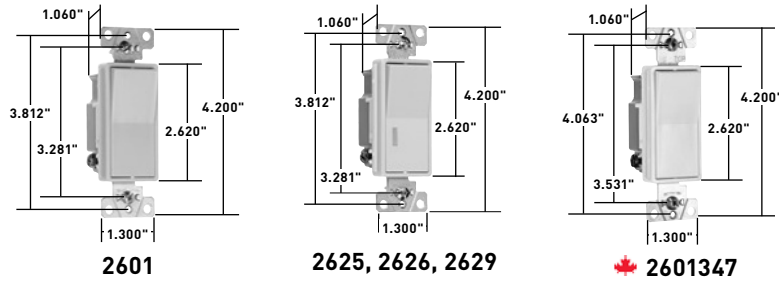

Features

- Impact-resistant polycarbonate back body and frame.
- Cushioned thermoplastic paddle assures smooth, quiet long-term operation.
- Unique single rocking butterfly contact provides long-term consistent performance with significantly fewer moving parts.
- Internal screw-pressure-plate back and side wire capability for easy installation with #14 - #10 AWG stranded or solid copper/copper clad wire. Terminals made of high conductivity brass and serrated for maximum wire gripping.
- Silver alloy contacts integrally formed to the butterfly actuator assures reliable performance.
- Integral auto-ground clip for positive ground to metal boxes.
- Tri-drive ground, terminal and mounting screws. All terminal screws backed out, ready-to-install.

CATALOG NUMBER				RATING			3rd PARTY COMPLIANCE	
SINGLE POLE	DOUBLE POLE	THREE-WAY	FOUR-WAY	A.	VAC	COLOR	UL20	C22.2 111
SPECIFICATION GRADE PADDLE SWITCHES BACK & SIDE WIRE								
2601I		2603I	2604I	15	120/277	Ivory	•	•
2601W		2603W	2604W	15	120/277	White	•	•
2601GRY		2603GRY		15	120/277	Gray	•	•
2601BK		2603BK		15	120/277	Black	•	•
2601LA		2603LA	2604LA	15	120/277	Light Almond	•	•
2621I	2622I	2623I	2624I	20	120/277	Ivory	•	•
2621W	2622W	2623W	2624W	20	120/277	White	•	•
2621	2622	2623	2624	20	120/277	Brown	•	•
2621GRY	2622GRY	2623GRY	2624GRY	20	120/277	Gray	•	•
2621BK	2622BK	2623BK	2624BK	20	120/277	Black	•	•
2621RED		2623RED	2624RED	20	120/277	Red	•	•
2621LA	2622LA	2623LA	2624LA	20	120/277	Light Almond	•	•
ILLUMINATED PADDLE SWITCHES (LIGHTED WHEN OFF) BACK & SIDE WIRE								
2625I		2626I	2628I	20	120	Ivory	•	•
2625W		2626W	2628W	20	120	White	•	•
2625				20	120	Brown	•	•
2625LA		2626LA	2628LA	20	120	Light Almond	•	•
PILOT LIGHTED PADDLE SWITCHES (LIGHTED WHEN ON) BACK & SIDE WIRE								
2629I				20	120	Ivory	•	•
2629W				20	120	White	•	•
2629LA				20	120	Light Almond	•	•
2629BK				20	120	Black	•	•

For Bulk Packaging Solutions consult factory.

CATALOG NUMBER			RATING			3rd PARTY COMPLIANCE	
SINGLE POLE	THREE-WAY	FOUR-WAY	A.	VAC	COLOR	UL20	C22.2 111
SPECIFICATION GRADE PADDLE SWITCHES BACK & SIDE WIRE							
2601347I	2603347I		15	347	Ivory	•	•
2601347W	2603347W		15	347	White	•	•
2621347I	2623347I	2624347I	20	347	Ivory	•	•
2621347W	2623347W	2624347W	20	347	White	•	•
2621347GRY			20	347	Gray	•	•
2621347BK			20	347	Black	•	•
2621347RED	2623347RED		20	347	Red	•	•

Denotes Canadian catalog number. All Canadian products have Combination Slotted/Robertson Head Brass Screws.

SWITCHES

SWITCHES

the radiant[®] collection

radiant[®] & Specification Grade Momentary & Maintained Contact Switches 15A, 120 & 120/277VAC



TM870STMLACC6

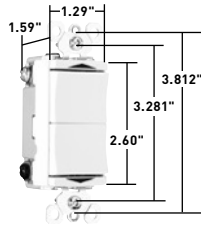

Momentary Contact

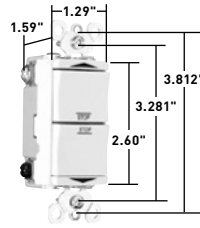

Maintained Contact

The radiant[®] collection is a step up from the standard with simple, classic options in wiring devices, home automation controls, and screwless wall plates that complement today's homes and hospitality settings.

Features

- Part of the radiant[®] collection.
- High-impact resistant thermoplastic construction.
- External screw-pressure-plate back and side wired. Accepts #12 and #14 AWG.
- Push wire #14 AWG.
- Narrow back body leaves more room for wires in the box.
- Extra-long, through-body strap eliminates floating installations and imperfect applications.
- Smooth, quiet paddle action.
- Easy-access green hex head ground screw.
- Tri-drive ground, terminal and mounting screws.

CATALOG NUMBER	RATING		COLOR	3rd PARTY COMPLIANCE	
	A.	VAC		UL [®] UL20	SB [®] C22.2 111
SINGLE POLE RADIANT[®] MOMENTARY CONTACT SWITCHES					
TM870STMWCC6	15	120/277	White	•	•
TM870STMICC6	15	120/277	Ivory	•	•
TM870STMBKCC6	15	120/277	Black	•	•
TM870STMLACC6	15	120/277	Light Almond	•	•

Features

- Unique "Up/Down" switches match the look and feel of standard switches.
- Impact-resistant face and body.
- Side and external screw-pressure-plate back wire accepts #12 and #14 AWG.
- All screws are tri-drive.
- Full wraparound heavy-gauge steel strap is plated for corrosion resistance and features lock-in tabs.
- Patent-pending split circuit tab – easily accessible, and can be reinstalled without a tool.

CATALOG NUMBER	RATING		COLOR	3rd PARTY COMPLIANCE		
	A.	VAC		cULus [®]	UL20 [®]	UL508 [®]
SPECIFICATION GRADE DOUBLE THROW MOMENTARY CONTACT SWITCHES						
TM811DTMOI	15	120	Ivory	•		•
TM811DTMOW	15	120	White	•		•
TM811DTMOBK	15	120	Black	•		•
TM811DTMOLA	15	120	Light Almond	•		•
SPECIFICATION GRADE DOUBLE THROW MAINTAINED CONTACT SWITCHES						
TM811DTMAI	15	120	Ivory	•	•	
TM811DTMAW	15	120	White	•	•	
TM811DTMABK	15	120	Black	•	•	
TM811DTMALA	15	120	Light Almond	•	•	

SWITCHES

TradeMaster® Grounding Toggle Switches 15A, 120VAC

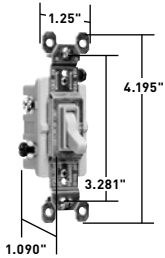

663IG

Features

- Thermoplastic toggle and frame.
- Extra-long strap.
- High-impact resistant construction.
- Side wire #12 and #14 AWG; push wire #14 AWG.
- Tri-drive ground, terminal and mounting screws.
- Easy-access green hex head ground screw.
- Smooth, quiet toggle action.

CATALOG NUMBER	RATING		COLOR	3rd PARTY COMPLIANCE		
	A.	VAC		UL20	FSUL WS896	C22.2 111
SINGLE POLE TOGGLE SWITCHES GROUNDING						
660IG*	15	120	Ivory	•		•
660WG*	15	120	White	•		•
660G*	15	120	Brown	•		•
660BKG	15	120	Black	•		•
660LAG*	15	120	Light Almond	•		•
SINGLE POLE TOGGLE SWITCHES GROUNDING (WITHOUT EARS)						
660IGMH	15	120	Ivory	•		•
660WGMH	15	120	White	•		•
660GMH	15	120	Brown	•		•
NAFTA-COMPLIANT SINGLE POLE TOGGLE SWITCHES GROUNDING						
660NAIG	15	120	Ivory		•	
660NAWG	15	120	White		•	
660NAG	15	120	Brown		•	
660NABKG	15	120	Black		•	
660NALAG	15	120	Light Almond		•	
THREE-WAY TOGGLE SWITCHES GROUNDING						
663IG*	15	120	Ivory	•		•
663WG*	15	120	White	•		•
663G*	15	120	Brown	•		•
663BKG	15	120	Black	•		•
663LAG*	15	120	Light Almond	•		•
NAFTA-COMPLIANT THREE-WAY TOGGLE SWITCHES GROUNDING						
663IG	15	120	Ivory		•	
663WG	15	120	White		•	
663G	15	120	Brown		•	
663BKG	15	120	Black		•	
663LAG	15	120	Light Almond		•	
FOUR-WAY TOGGLE SWITCHES GROUNDING						
664IG	15	120	Ivory	•		•
664WG	15	120	White	•		•
664G	15	120	Brown	•		•
664BKG	15	120	Black	•		•
664LAG	15	120	Light Almond	•		•
* 664ICN	15	120	Ivory	•		•
* 664WCN	15	120	White	•		•
NAFTA-COMPLIANT FOUR-WAY TOGGLE SWITCHES GROUNDING						
664IG	15	120	Ivory		•	
664WG	15	120	White		•	
664G	15	120	Brown		•	
664BKG	15	120	Black		•	
664LAG	15	120	Light Almond		•	

* Denotes Canadian catalog number. All Canadian products have Combination Slotted/Robertson Head Brass Screws.

* Available in bulk packs of 120. Please contact customer support.

NAFTA-Compliant Switches are ideal for use on projects subject to the provisions of the Buy American Act.

SWITCHES

TradeMaster® Grounding Illuminated & Self-Grounding Toggle Switches 15A, 120VAC

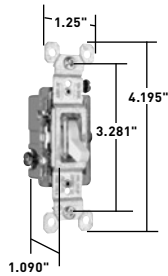

660ISLG

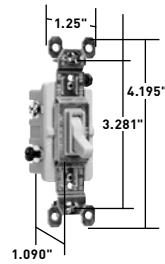

663SIG

Features

- Thermoplastic toggle and frame.
- Extra-long strap.
- High-impact resistant construction.
- Side wire #12 and #14 AWG.
- Push wire #14 AWG.
- Tri-drive ground, terminal and mounting screws.
- Easy-access green hex head ground screw.
- Smooth, quiet toggle action.
- Self-grounding models provide automatic ground clip.

CATALOG NUMBER	RATING		COLOR	3rd PARTY COMPLIANCE	
	A.	VAC		UL20	C22.2 111
SINGLE POLE ILLUMINATED TOGGLE SWITCHES GROUNDING (LIGHTED WHEN OFF)					
660ISLG	15	120	Ivory	•	•
660WSLG	15	120	White	•	•
660LASLG	15	120	Light Almond	•	•
SELF-GROUNDING SINGLE POLE TOGGLE SWITCHES					
660SIG	15	120	Ivory	•	•
660SWG	15	120	White	•	•
660SG	15	120	Brown	•	•
660SLAG	15	120	Light Almond	•	•
THREE-WAY ILLUMINATED TOGGLE SWITCHES GROUNDING (LIGHTED WHEN OFF)					
663ISLG	15	120	Ivory	•	•
663WSLG	15	120	White	•	•
663LASLG	15	120	Light Almond	•	•
SELF-GROUNDING THREE-WAY TOGGLE SWITCHES					
663SIG	15	120	Ivory	•	•
663SWG	15	120	White	•	•
663SG	15	120	Brown	•	•
663SLAG	15	120	Light Almond	•	•
SELF-GROUNDING FOUR-WAY TOGGLE SWITCHES					
664SIG	15	120	Ivory	•	•
664SWG	15	120	White	•	•
664SG	15	120	Brown	•	•
664SLAG	15	120	Light Almond	•	•

SWITCHES

the radiant® collection

radiant® Switches 15A, 120/277VAC

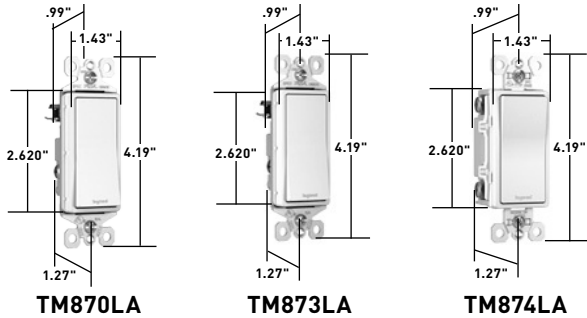

The radiant® collection is a step up from the standard with simple, classic options in wiring devices, home automation controls, and screwless wall plates that complement today's homes and hospitality settings.

Features

- Part of the radiant® collection.
- Smooth paddle action.
- High-impact resistant thermoplastic construction.
- External screw-pressure-plate back and side wired. Accepts #12 and #14 AWG.
- Push wire #14 AWG.
- Narrow back body leaves more room for wires in the box.
- Extra-long, through-body strap eliminates floating installations and imperfect applications.
- Easy-access green hex head ground screw.
- Tri-drive ground, terminal and mounting screws.
- ON-OFF switches conform to NEC 430-104 requirements for kitchen disposal units.

CATALOG NUMBER	RATING		COLOR	3rd PARTY COMPLIANCE		
	A.	V.		UL20	cULus	C22.2 111
SINGLE POLE RADIANT® SWITCHES GROUNDING						
TM870I	15	120/277	Ivory	•		•
TM870W	15	120/277	White	•		•
TM870	15	120/277	Brown	•		•
TM870GRY	15	120/277	Gray	•		•
TM870BK	15	120/277	Black	•		•
TM870DBCC10	15	120/277	Dark Bronze	•		•
TM870LA	15	120/277	Light Almond	•		•
TM870NICC10	15	120/277	Nickel	•		•
NAFTA-COMPLIANT SINGLE POLE RADIANT® SWITCHES GROUNDING						
TM870NAI	15	120	Ivory		•	
TM870NAW	15	120	White		•	
TM870NA	15	120	Brown		•	
TM870NAGRY	15	120	Gray		•	
TM870NABK	15	120	Black		•	
TM870NALA	15	120	Light Almond		•	
THREE-WAY RADIANT® SWITCHES GROUNDING						
TM873I	15	120/277	Ivory	•		•
TM873W	15	120/277	White	•		•
TM873	15	120/277	Brown	•		•
TM873GRY	15	120/277	Gray	•		•
TM873DBCC10	15	120/277	Dark Bronze	•		•
TM873BK	15	120/277	Black	•		•
TM873LA	15	120/277	Light Almond	•		•
TM873NICC10	15	120/277	Nickel	•		•
NAFTA-COMPLIANT THREE-WAY RADIANT® SWITCHES GROUNDING						
TM873NAI	15	120	Ivory		•	
TM873NAW	15	120	White		•	
TM873NA	15	120	Brown		•	
TM873NAGRY	15	120	Gray		•	
TM873NABK	15	120	Black		•	
TM873NALA	15	120	Light Almond		•	
FOUR-WAY RADIANT® SWITCHES GROUNDING						
TM874I	15	120/277	Ivory	•		•
TM874W	15	120/277	White	•		•
TM874	15	120/277	Brown	•		•
TM874BK	15	120/277	Black	•		•
TM874DBCC6	15	120/277	Dark Bronze	•		•
TM874GRY	15	120/277	Gray	•		•
TM874LA	15	120/277	Light Almond	•		•
TM874NICC6	15	120/277	Nickel	•		•
NAFTA-COMPLIANT FOUR-WAY RADIANT® SWITCHES GROUNDING						
TM874I	15	120	Ivory		•	
TM874W	15	120	White		•	
TM874	15	120	Brown		•	
TM874BK	15	120	Black		•	
TM874LA	15	120	Light Almond		•	

NAFTA-Compliant Switches are ideal for use on projects subject to the provisions of the Buy American Act.

All devices listed on this page conform to NEMA WD-1 and WD-6.

SWITCHES

the radiant[®]
collection

radiant[®] Illuminated & Self-Grounding Paddle Switches 15A, 120 & 120/277VAC

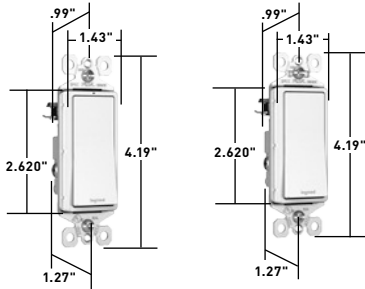

TM870LASL

TM870SLA

The radiant[®] collection is a step up from the standard with simple, classic options in wiring devices, home automation controls, and screwless wall plates that complement today's homes and hospitality settings.

Features

- Part of the radiant[®] collection.
- Smooth paddle action.
- White LED indicator light is centered at the top of the frame for easy detection in the dark.
- High-impact resistant thermoplastic construction.
- External screw-pressure-plate back and side wired. Accepts #12 and #14 AWG.
- Push wire #14 AWG.
- Narrow back body leaves more room for wires in the box.
- Extra-long, through-body strap eliminates floating installations and imperfect applications.
- Easy-access green hex head ground screw.
- Tri-drive ground, terminal and mounting screws.
- Self-grounding models provide automatic ground clip.

CATALOG NUMBER	RATING		COLOR	3rd PARTY COMPLIANCE	
	A.	VAC		UL [®] UL20	SB [®] C22.2 111
SINGLE POLE ILLUMINATED RADIANT[®] SWITCHES GROUNDING (LIGHTED WHEN OFF)					
TM870ISL	15	120	Ivory	•	•
TM870WSL	15	120	White	•	•
TM870LASL	15	120	Light Almond	•	•
SELF-GROUNDING SINGLE POLE RADIANT[®] SWITCHES					
TM870SI	15	120/277	Ivory	•	•
TM870SW	15	120/277	White	•	•
TM870S	15	120/277	Brown	•	•
TM870SBK	15	120/277	Black	•	•
TM870SLA	15	120/277	Light Almond	•	•
THREE-WAY ILLUMINATED RADIANT[®] SWITCHES GROUNDING (LIGHTED WHEN OFF)					
TM873ISL	15	120	Ivory	•	•
TM873WSL	15	120	White	•	•
TM873LASL	15	120	Light Almond	•	•
SELF-GROUNDING THREE-WAY RADIANT[®] SWITCHES					
TM873SI	15	120/277	Ivory	•	•
TM873SW	15	120/277	White	•	•
TM873S	15	120/277	Brown	•	•
TM873SBK	15	120/277	Black	•	•
TM873SLA	15	120/277	Light Almond	•	•
FOUR-WAY ILLUMINATED RADIANT[®] SWITCHES GROUNDING (LIGHTED WHEN OFF)					
TM874ISL	15	120	Ivory	•	•
TM874WSL	15	120	White	•	•
TM874LASL	15	120	Light Almond	•	•
SELF-GROUNDING FOUR-WAY RADIANT[®] SWITCHES					
TM874SI	15	120/277	Ivory	•	•
TM874SW	15	120/277	White	•	•
TM874S	15	120/277	Brown	•	•
TM874SBK	15	120/277	Black	•	•
TM874SLA	15	120/277	Light Almond	•	•

SWITCHES

TradeMaster® Combination Switches 15 & 20A, 120/277VAC; 15 & 20A, 120/125VAC; 15A, 120VAC

Features

- Easily accessible break-off for separate or common feed.
- Long-life red neon lamp in pilot light rated 1/25 Watt, 125V.
- Side wire #12 and #14 AWG.
- Two devices fit into the space of one.
- Grounding combination devices meet NEC Requirements.
- Tamper-resistant version features dual mechanical shutter system to help prevent insertion of foreign objects.

CATALOG NUMBER	RATING		COLOR	NEMA CONFIG. NO.	3rd PARTY COMPLIANCE	
	A.	VAC			UL20	UL498
SINGLE POLE SWITCH & TAMPER-RESISTANT SINGLE RECEPTACLE SIDE WIRE, GROUNDING						
691TRI	15	120/125	Ivory	5-15R	•	•
691TRW	15	120/125	White	5-15R	•	•
691TR	15	120/125	Brown	5-15R	•	•
691TRLA	15	120/125	Light Almond	5-15R	•	•
671TRI	20	120/125	Ivory	5-20R	•	•
671TRW	20	120/125	White	5-20R	•	•
671TR	20	120/125	Brown	5-20R	•	•
671TRLA	20	120/125	Light Almond	5-20R	•	•
TWO SINGLE POLE SWITCHES SIDE WIRE, GROUNDING						
690IG	15	120/277	Ivory		•	
690WG	15	120/277	White		•	
690G	15	120/277	Brown		•	
690LAG	15	120/277	Light Almond		•	
670IG	20	120/277	Ivory		•	
670WG	20	120/277	White		•	
670G	20	120/277	Brown		•	
670LAG	20	120/277	Light Almond		•	
SINGLE POLE & THREE-WAY SWITCH SIDE WIRE, GROUNDING						
696IG	15	120/277	Ivory		•	
696WG	15	120/277	White		•	
696G	15	120/277	Brown		•	
696LAG	15	120/277	Light Almond		•	
TWO THREE-WAY SWITCHES SIDE WIRE, GROUNDING						
693IG	15	120/277	Ivory		•	
693WG	15	120/277	White		•	
693G	15	120/277	Brown		•	
693LAG	15	120/277	Light Almond		•	
SINGLE POLE SWITCH & SINGLE RECEPTACLE SIDE WIRE, GROUNDING						
691I	15	120/125	Ivory	5-15R	•	•
691W	15	120/125	White	5-15R	•	•
691	15	120/125	Brown	5-15R	•	•
691LA	15	120/125	Light Almond	5-15R	•	•
671I	20	120/125	Ivory	5-20R	•	•
671W	20	120/125	White	5-20R	•	•
671	20	120/125	Brown	5-20R	•	•
671LA	20	120/125	Light Almond	5-20R	•	•
SINGLE POLE SWITCH & PILOT LIGHT SIDE WIRE, GROUNDING						
692IG	15	120	Ivory		•	
692WG	15	120	White		•	
692G	15	120	Brown		•	
692LAG	15	120	Light Almond		•	
THREE-WAY SWITCH & PILOT LIGHT SIDE WIRE, GROUNDING						
695IG	15	120	Ivory		•	
695WG	15	120	White		•	
695G	15	120	Brown		•	
695LAG	15	120	Light Almond		•	

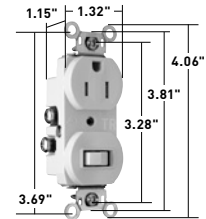

Combination Switch & Tamper-Resistant Receptacle

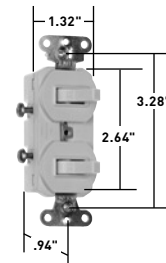

Combination Switches

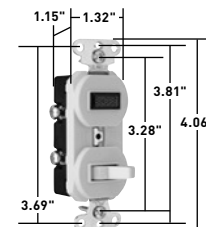

Combination Switch & Pilot Light

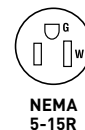

SWITCHES

TradeMaster® Combination Switches 15 & 20A, 120/277VAC; 15A, 120/125VAC; 15A, 120VAC

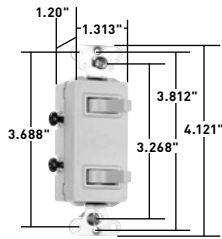

**Paddle-Style
Combination Switch**

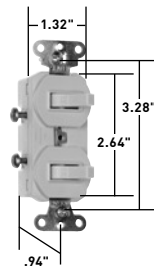

**Combination
Switches**

CATALOG NUMBER	RATING		COLOR	NEMA CONFIG. NO.	3rd PARTY COMPLIANCE	
	A.	VAC			UL20	UL498
TWO SINGLE POLE SWITCHES SIDE WIRE GROUNDING (FITS PADDLE-STYLE WALL PLATES)						
680IG	15	120/277	Ivory		•	
680WG	15	120/277	White		•	
680LAG	15	120/277	Light Almond		•	
SINGLE POLE SWITCH & SINGLE RECEPTACLE SIDE WIRE GROUNDING (FITS PADDLE-STYLE WALL PLATES)						
681I	15	120/125	Ivory	5-15R	•	•
681W	15	120/125	White	5-15R	•	•
681LA	15	120/125	Light Almond	5-15R	•	•

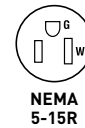

Non-Grounding

CATALOG NUMBER	RATING		COLOR	3rd PARTY COMPLIANCE	
	A.	VAC		UL20	UL498
TWO SINGLE POLE SWITCHES SIDE WIRE NON-GROUNDING					
690I	15	120/277	Ivory	•	
690W	15	120/277	White	•	
690	15	120/277	Brown	•	
670I	20	120/277	Ivory	•	
670W	20	120/277	White	•	
670	20	120/277	Brown	•	
SINGLE POLE & THREE-WAY SWITCH SIDE WIRE NON-GROUNDING					
696I	15	120/277	Ivory	•	
696W	15	120/277	White	•	
696	15	120/277	Brown	•	
696LA	15	120/277	Light Almond	•	
TWO THREE-WAY SWITCHES SIDE WIRE NON-GROUNDING					
693I	15	120/277	Ivory	•	
693W	15	120/277	White	•	
693	15	120/277	Brown	•	
693LA	15	120/277	Light Almond	•	
SINGLE POLE SWITCH & PILOT LIGHT SIDE WIRE NON-GROUNDING					
692I	15	120	Ivory	•	•
692W	15	120	White	•	•
692	15	120	Brown	•	•
692LA	15	120	Light Almond	•	•
THREE-WAY SWITCH & PILOT LIGHT SIDE WIRE NON-GROUNDING					
695I	15	120	Ivory	•	
695W	15	120	White	•	
695	15	120	Brown	•	
695LA	15	120	Light Almond	•	
TWO SINGLE POLE SWITCHES SIDE WIRE NON-GROUNDING					
680I	15	120/277	Ivory	•	
680W	15	120/277	White	•	
680LA	15	120/277	Light Almond	•	

All devices listed on this page conform to NEMA WD-1 and WD-6.

SWITCHES

Specification Grade Paddle Combination Switches 20A, 277VAC

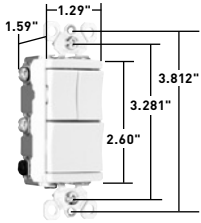

15 & 20 Amp

Features

- Unique “Up/Down” switches match the look and feel of standard paddle switches.
- Impact-resistant face and body.
- Side and external screw pressure plate back wire accepts #12 and #14 AWG.
- All screws are tri-drive.
- Full wraparound heavy-gauge steel strap is plated for corrosion resistance and features lock-in tabs.
- Patent-pending split circuit tab – easily accessible, and can be reinstalled without a tool.
- Patent-pending snap-in light module (sold separately) transforms a combination switch into an illuminated switch.

CATALOG NUMBER	RATING		COLOR	3rd PARTY COMPLIANCE	
	A.	VAC		 cULus	 UL20
TWO SINGLE POLE SWITCHES					
PS81120I	20	277	Ivory	•	•
PS81120W	20	277	White	•	•
PS81120LA	20	277	Light Almond	•	•
THREE SINGLE POLE SWITCHES					
PS811120I	20	277	Ivory	•	•
PS811120W	20	277	White	•	•
PS811120LA	20	277	Light Almond	•	•
SNAP-IN LIGHT MODULE*					
PS8LM	—	—	Clear		

*For use with PS81120 and PS811120 only.

SWITCHES

radiant® Combination Switches

the radiant®
collection

RCD113W radiant® Combination Switches

- A. Unique “Up/Down” switches** match the look and feel of standard paddle switches.
- B. Easy-to-use oversized main switch** for primary load.
- C. Patented Snap-In Light Module** (sold separately) transforms a combination switch into an illuminated switch in seconds.
- D. Impact-resistant face and body.**
- E. Full wraparound metal strap**, commercial grade with lock-in tabs.
- F. All screws are tri-drive.**
- G. External screw-pressure-plate back and side wired.** Accepts #12 and #14 AWG.

The radiant® collection is a step up from the standard with simple, classic options in wiring devices, home automation controls, and screwless wall plates that complement today’s homes and hospitality settings.

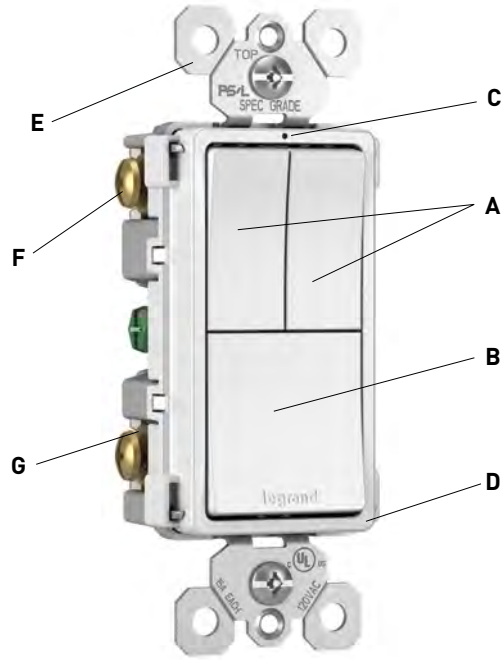

RCD113W

Features

- Module simply snaps-in for easy installation.

Snap-In Light Module:

- Lights when OFF.
- Uses energy-efficient LED light.
- LED light will not generate heat and will last, on average, 47 years.



RCDLM

CATALOG NUMBER	RATING		COLOR	3rd PARTY COMPLIANCE
	A.	VAC		 cULus
RADIANT® LOCATOR LIGHT MODULE				
RCDLM	15	120/125	Clear	•

Adding a Snap-In Light Module

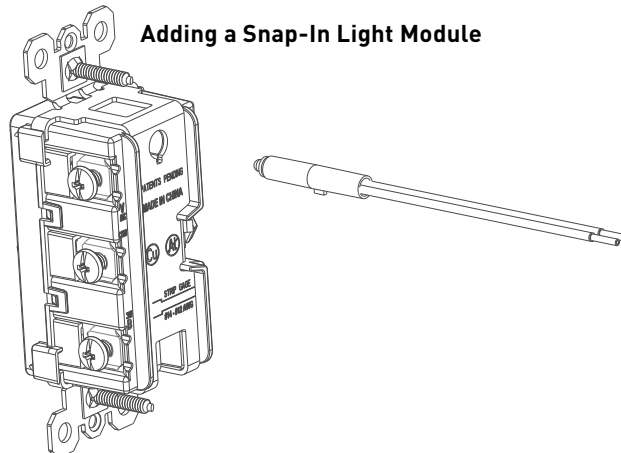

SWITCHES

radiant® Combination Switches 15A, 120/125VAC

the
radiant®
collection

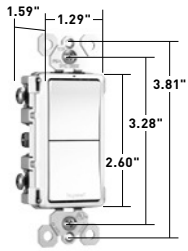
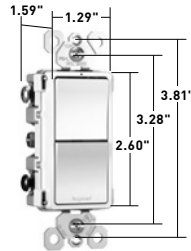
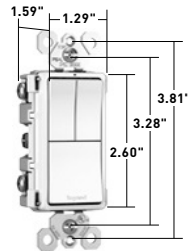
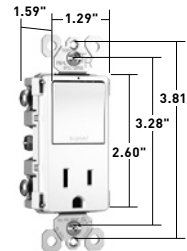
RCD11W

RCD33W

RCD113W

RCD38TRW

Features

- Part of the radiant® collection
- Impact-resistant face and body.
- External screw-pressure-plate back and side wired. Accepts #12 and #14 AWG.
- Full wraparound metal strap with lock-in tabs.
- Unique "Up/Down" switches match the look and feel of standard paddle switches.
- Largest breadth of 15 amp offering.
- All screws are tri-drive.
- Protects children: patented shutter system – now with black "invisi-shutters" that disappear for an invisible effect – helps prevent improper insertion of foreign objects.
- Single Pole/3-Way Switches can be wired as a single pole or 3-way switch.

CATALOG NUMBER	RATING		COLOR	3rd PARTY COMPLIANCE	
	A.	VAC		UL20	cULus
TWO SINGLE POLE SWITCHES					
RCD11I	15	120/125	Ivory	•	•
RCD11W	15	120/125	White	•	•
RCD11BK	15	120/125	Black	•	•
RCD11LA	15	120/125	Light Almond	•	•
TWO SINGLE POLE/3-WAY SWITCHES					
RCD33I	15	120/125	Ivory	•	•
RCD33W	15	120/125	White	•	•
RCD33BK	15	120/125	Black	•	•
RCD33LA	15	120/125	Light Almond	•	•
TWO SINGLE POLE SWITCHES & SINGLE POLE/3-WAY SWITCH					
RCD113I	15	120/125	Ivory	•	•
RCD113W	15	120/125	White	•	•
RCD113BK	15	120/125	Black	•	•
RCD113LA	15	120/125	Light Almond	•	•

The radiant® collection is a step up from the standard with simple, classic options in wiring devices, home automation controls, and screwless wall plates that complement today's homes and hospitality settings.

CATALOG NUMBER	RATING		COLOR	NEMA CONFIG. NO.	3rd PARTY COMPLIANCE		
	A.	VAC			UL20	UL498	cULus
SINGLE POLE/3-WAY SWITCH & TAMPER-RESISTANT SINGLE RECEPTACLE							
RCD38TRI	15	120/125	Ivory	5-15R	•	•	•
RCD38TRW	15	120/125	White	5-15R	•	•	•
RCD38TRBK	15	120/125	Black	5-15R	•	•	•
RCD38TRLA	15	120/125	Light Almond	5-15R	•	•	•

STRAIGHT BLADE RECEPTACLES

the radiant[®]
collection

radiant[®] USB Chargers with Tamper-Resistant Receptacles 15A, 125V

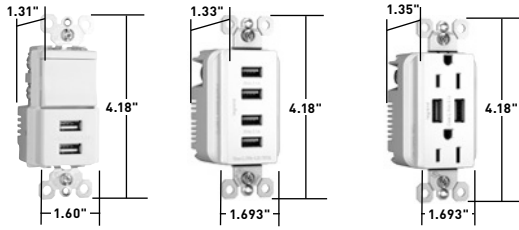

TM83USBW TM8USB4W TM826USBW

The radiant[®] collection is a step up from the standard with simple, classic options in wiring devices, home automation controls, and screwless wall plates that complement today's homes and hospitality settings.

Features

- Part of the radiant[®] collection.
- Charge multiple USB powered devices at the same time.
- Allow users to plug USB cables directly without AC adapters or transformer style plugs.
- Now with black "invisi-shutters" for an invisible effect preferred by end users.
- Back and side wire terminals.
- Compatible with USB 2.0 and 3.0 devices.
- Accepts standard Pass & Seymour wall plates and radiant[®] screwless wall plates (see pages S-6 and S-7).
- Compact design.
- All AC outlets are tamper-resistant.
- Meets NEC standards.

CATALOG NUMBER	RATING		COLOR	TOTAL CHARGING CAPACITY	3rd PARTY COMPLIANCE		
	A.	V.			UL1310	ETL	cULus
USB CHARGERS WITH SINGLE POLE/3-WAY SWITCH							
TM83USBICC6	15	120	Ivory	2.1 Amp		•	•
TM83USBWCC6	15	120	White	2.1 Amp		•	•
TM83USBKCC6	15	120	Black	2.1 Amp		•	•
TM83USBLACC6	15	120	Light Almond	2.1 Amp		•	•
TM83USBNICC6	15	120	Nickel	2.1 Amp		•	•
USB QUAD CHARGERS							
TM8USB4ICC6			Ivory	4.2 Amp	•		
TM8USB4WCC6			White	4.2 Amp	•		
TM8USB4BKCC6			Black	4.2 Amp	•		
TM8USB4LACC6			Light Almond	4.2 Amp	•		
TM8USB4NICC6			Nickel	4.2 Amp	•		

Features

- Overall 3.1A USB charging capability.
- Combination AC duplex receptacles include two 5-volt DC USB ports that work with USB 2.0 & 3.0 compatible devices.
- AC receptacles available in 15A, 125V.
- Now with black "invisi-shutters" for an invisible effect preferred by end users.
- AC receptacles are tamper-resistant to meet NEC Code – patented shutter system prevents improper insertion of foreign objects.
- Back and side wire terminals accommodate #14 AWG – #10 AWG stranded and solid copper wire.
- Multiple color options available.

CATALOG NUMBER	RATING		COLOR	TOTAL CHARGING CAPACITY	3rd PARTY COMPLIANCE		
	A.	V.			UL498 UL1310	cULus	CSA C22.2 No. 42 C22.2 No. 223
USB CHARGERS WITH DUPLEX TAMPER-RESISTANT RECEPTACLES							
TM826USBICC6	15	125	Ivory	3.1 Amp	•	•	•
TM826USBWCC6	15	125	White	3.1 Amp	•	•	•
TM826USBKCC6	15	125	Black	3.1 Amp	•	•	•
TM826USBLACC6	15	125	Light Almond	3.1 Amp	•	•	•
TM826USBNICC6	15	125	Nickel	3.1 Amp	•	•	•

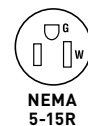

SWITCHES

GFCIs

radiant® Combination Switch / Self-Test GFCI Tamper-Resistant Receptacle with SafeLock® Protection 15A, 125VAC

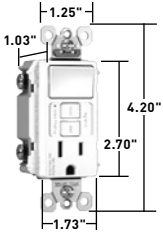

1597SWTTRWCC4

The radiant® collection is a step up from the standard with simple, classic options in wiring devices, home automation controls, and screwless wall plates that complement today's homes and hospitality settings.

Features

- Part of the radiant® collection.
- Protects children: patented shutter system helps prevent improper insertion of foreign objects.
- Meets National Electrical Code® Tamper-Resistant requirements.
- Conducts an automatic test every three seconds, ensuring it's always ready to protect. If the device fails the test, the indicator light flashes to signal that the GFCI should be replaced. It also has our proven SafeLock® Protection feature: if critical components are damaged and protection is lost, power to the receptacle is disconnected.
- Thinner than competitors' GFCI Receptacles: leaves more room for wires in the box.
- Auto-Ground clip assures a positive ground to metal box.
- Feed-thru wiring configuration allows GFCI to protect downstream receptacles.
- Prevents line-load reversal miswire: no power to the face or downstream receptacles if wired incorrectly.
- Exceeds UL943 voltage surge requirements.
- Trip indicator light (red LED).
- Two back wire holes per terminal.
- Side or internal screw-pressure-plate back wire with #10 – #14 AWG solid or stranded copper wire.
- Ground screw has a back wire clamp for easy installation.
- 10kA short circuit rating.
- Mounting screws are shipped captive in the device and wall plate for easier installation.
- High-impact-resistant thermoplastic construction.
- Extra-long strap.
- Button colors match the device face.
- Dual-direction test and reset buttons.
- Class A rated GFCI.
- Supplied with matching TP26 nylon wall plate.
- Tri-drive screws.

Specifications

- Supply Voltage: 125VAC, 60 Hz
- Supply Voltage Range: 102-132 VAC
- Trio Threshold: 5± 1mA
- Trip Time: 0.025 sec., nominal per UL Standard
- 20 Amp feed-thru capacity

CATALOG NUMBER	SWITCH RATING		RECEPTACLE RATING		COLOR	NEMA CONFIG. NO.	3rd PARTY COMPLIANCE		
	A.	VAC	A.	VAC			UL943 C22.2 No. 144	UL498 C22.2 No. 42	UL943 C22.2 No. 144
RADIANT® COMBINATION TAMPER-RESISTANT SINGLE POLE SWITCH/GFCI									
1597SWTTRICC4	15	120	15	125	Ivory	5-15R	•	•	•
1597SWTTRWCC4	15	120	15	125	White	5-15R	•	•	•
1597SWTTRBKCC4	15	120	15	125	Black	5-15R	•	•	•
1597SWTTRLACC4	15	120	15	125	Light Almond	5-15R	•	•	•

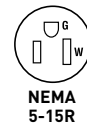

SWITCHES

Canopy Switches & Locator Switches & Shim-Lock 15A, 120 & 250VAC; 15A, 120VAC

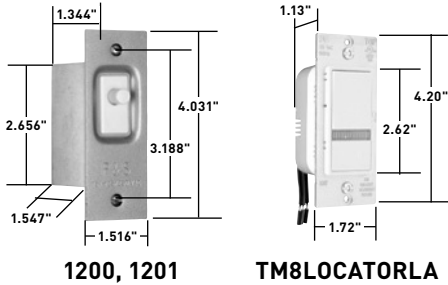

1200, 1201

TM8LOCATORLA

CATALOG NUMBER		RATING AC	
LIGHT ON DOOR OPEN	LIGHT ON DOOR CLOSED	120VAC	250VAC
PRESSURE SENSITIVE DOOR & CANOPY SWITCHES			
1200	1201	15A	15A
INTERIORS ONLY, WITH LEADS, PLUNGER & FACE PLATE			
1205A	1206A	15A	15A

Features

- Equipped with wire leads.
- 1200 and 1201 complete with metal box and plate.
- Only 14 oz. pressure actuates switch.
- Back box cold rolled steel.
- Plate is steel with a bronze coating.

Application

In an emergency, seconds can make all the difference. Easily make a home instantly identifiable with a P&S Home Locator Switch. Just a single touch on its lower push button flashes the front outside lights continuously. The switch's LED flashes red to indicate the locator is in operation. When the locator flasher isn't in use, the switch's LED glows green for easy location in the dark.

Features

- ON/OFF switch with normal paddle operation.
- Locator function flashes the outdoor light ON and OFF signaling SOS in Morse Code.
- Green LED illuminates and differentiates switch for easy location in emergency.
- Red LED indicates the emergency function is enabled.
- Wires the same as a single pole switch.
- cULus Listed.

CATALOG NUMBER	DESCRIPTION	RATING	COLOR
HOME LOCATOR SWITCHES			
TM8LOCATORI	Emergency Home Locator	500 Watts, 15A, 120VAC	Ivory
TM8LOCATORW			White
TM8LOCATORLA			Light Almond

Helps Emergency Personnel Locate Address

Used in conjunction with your call for assistance, the P&S Home Locator Switch solves the problem of night time house identification for emergency personnel. After you have placed your call for help, simply press the lower portion of the switch and your outdoor light will flash on and off continuously, cutting response time to insure effective action.

Features

- One Shim-Lock provides a device adjustment depth range between 1/8" and 3/4".
- An inexpensive and quick fix for floating installations.
- Provides a perfect flush mount every time regardless of the wallboard, tile or panel condition.
- Made of steel and finished with clear zinc chromate plating.

CATALOG NUMBER	DIMENSIONS	QTY. PER PACKAGE
SHIM-LOCK		
SHL20	Length: .310", Screw Opening: #6	20
SHL100	Length: .310", Screw Opening: #6	100



Shim-Lock

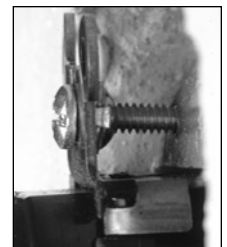

SWITCHES

Manual Controllers

7803MD Manual Controller

- A. Heavy-duty, zinc-plated strap** resists corrosion; two rolled-brass rivets secure the strap to the housing to avoid field tampering.
- B. Two-point contact arm design** reduces overall unit size; provides more enclosure space.
- C. Thermoplastic housing** resists tracking; withstands impacts.
- D. Two oversized silver alloy contacts** withstand years of use; improve heat dissipation by distributing arc energy.
- E. One-piece contact carrier** constructed of glass-reinforced thermoplastic ensures long-lasting “make and break” performance.
- F. Exclusive, ready-to-wire external screw-pressure-plate back and side wire** capability for easy installation with solid or stranded wire.

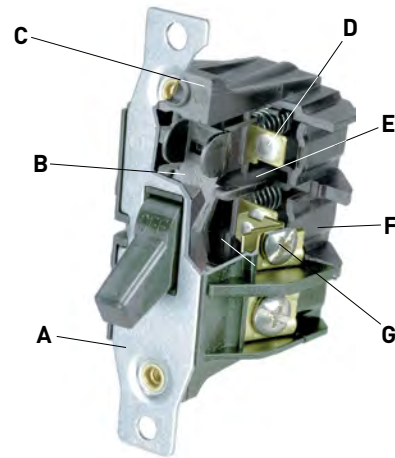

- G. Oversized #10 terminal screws** increase contact with wire and increase torque limit. Angled screw heads for easier access.

NEMA Type Enclosures

NEMA Type 1 Enclosures – Intended for indoor use primarily to provide a degree of protection against limited amounts of falling dirt in locations where unusual service conditions do not exist.

NEMA Type 7 Enclosures – Intended for indoor use in locations classified as Class 1, Group A, B, C, or D, as defined in the National Electrical Code. They shall be capable of withstanding the pressures resulting from an internal explosion of specified gases, and contain such an explosion sufficient that an explosive gas-air mixture existing in the atmosphere surrounding the enclosure will not be ignited. Enclosed heat generating devices shall not cause external surfaces to reach temperatures capable of igniting explosive gas-air mixtures in the surrounding atmosphere. Enclosures shall meet explosion, hydrostatic, and temperature design tests.

NEMA Type 3R Enclosures – Intended for outdoor use primarily to provide a degree of protection against rain and sleet; and to be undamaged by the formation of ice on the enclosure. They are not intended to provide protection against conditions such as internal condensation, or internal icing.

NEMA Type 9 Enclosures – Intended for indoor use in locations classified as Class II, Groups E, F, or G, as defined in the National Electrical Code. They shall be capable of preventing the entrance of dust. Enclosed heat generating devices shall not cause external surfaces to reach temperatures capable of igniting or discoloring dust on the enclosure or igniting dust-air mixtures in the surrounding atmosphere. Enclosures shall meet dust penetration and temperature design tests, and aging of gaskets (if used).

SWITCHES

Manual Controllers 30A, 1Ø & 3Ø

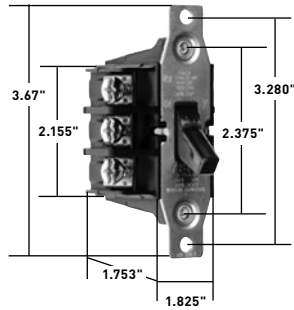

7802MD, 7803MD



7812PMD, 7813PMD

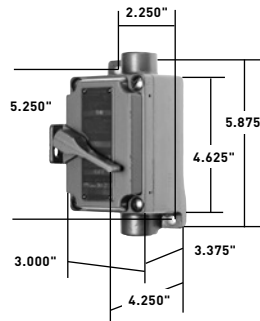

7812EX, 7813EX

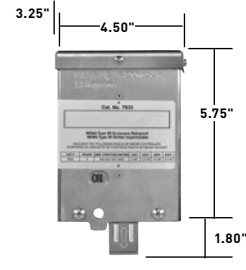

7832MD, 7833MD

Features – 7802MD & 7803MD

- High horsepower rating of 20HP
- Compact design.
- Gull-wing shaped brass terminal pressure clamps.
- Constructed of glass-reinforced thermoplastic.
- Two-point contact arms.
- One-piece contact carrier.
- UL508 and cULus Listing of individual device and assembled device within enclosure.
- Heavy-duty zinc-plated steel strap.
- Two brass rivets secure strap to housing.
- External screw-pressure-plate back and side wire terminal screws unstaked for use with ring terminals.
- Oversized silver alloy contacts.
- 2-3/4" hubs (7812EX and 7813EX).
- 2-1/2" knockouts on back and 2-1/2"-3/4" knockouts on top and bottom (7812PMD, 7813PMD, 7806P).
- 2-1/2" knockouts on bottom and back (7832MD and 7833MD).
- Slotted opening on enclosures allows for lock-out, tag-out functionality.

CATALOG NUMBER	DESCRIPTION	RATING			
		A.	V.	HP	VAC
DOUBLE POLE, SINGLE PHASE					
7802MD	Double Pole, Single Phase AC Manual Motor Controller (No overload protection), See Footnote 1	General Use 30	600 max.	2 3 7.5 10	120 240 480 600
7812PMD	7802MD in a NEMA 1 Enclosure, See Footnote 1	Same as 7802MD			
7812EX	7802MD in a NEMA 7 and 9 Enclosure for Hazardous Locations Class I - Groups C, D; Class II - Groups E, F, G	Same as 7802MD			
7832MD	7802MD in a NEMA 3R Enclosure, See Footnote 1	Same as 7802MD			
THREE POLE, THREE PHASE					
7803MD	Three Pole, Three Phase AC Manual Motor Controller (No overload protection), See Footnote 1	General Use 30	600 max.	3 7.5 10 20	120 240 480 600
7813PMD	7803MD in a NEMA 1 Enclosure, See Footnote 1	Same as 7803MD			
7813EX	7803MD in a NEMA 7 and 9 Enclosure for Hazardous Locations Class I - Groups C, D; Class II - Groups E, F, G	Same as 7803MD			
7833MD	7803MD in a NEMA 3R Enclosure, See Footnote 1	Same as 7803MD			
7806P	NEMA 1 Black Nylon Enclosure with 1/2" and 3/4" knockouts at each end.				
7801P	Handle Locking Guard has opening for padlock to secure control in either ON or OFF position.				
7830	NEMA 3R Aluminum Enclosure.				

All Industrial Control Equipment is suitable for use in a circuit capable of deliverable not more than 5,000 rms amperes at 600VAC maximum or equivalent.

Footnote 1. Suitable as Motor Disconnect – 10KA @ 600VAC, 30A max. Class J Fuse.

SWITCHES

Manual Controllers 40A, 1Ø & 3Ø

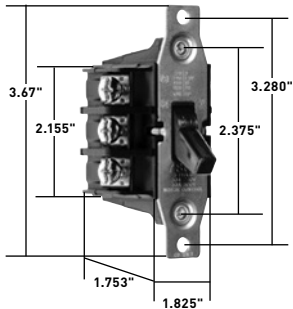

7842MD, 7843MD

Features – 7842MD & 7843MD

- High horsepower rating of 20HP
- Compact design.
- Gull-wing shaped brass terminal pressure clamps.
- Constructed of glass-reinforced thermoplastic.
- Two-point contact arms.
- One-piece contact carrier.
- Heavy-duty yellow chromate plated steel strap.
- Two brass rivets secure strap to housing.
- External screw-pressure-plate back and side wire terminal screws unstaked for use with ring terminals.
- Oversized silver alloy contacts.
- UL508 and cULus Listing of individual device and assembled device within enclosure.

CATALOG NUMBER	DESCRIPTION	RATING			
		A.	VAC	HP	VAC
DOUBLE POLE, SINGLE PHASE					
7842MD	Double Pole, Single Phase AC Manual Motor Controller (No overload protection), See Footnote 2	40	600 max.	2 5 10 15	120 240 480 600
THREE POLE, THREE PHASE					
7843MD	Three Pole, Three Phase AC Manual Motor Controller (No overload protection), See Footnote 2	40	600 max.	2 7.5 15 20	120 240 480 600

All Industrial Control Equipment is suitable for use in a circuit capable of deliverable not more than 5,000 rms amperes at 600VAC maximum or equivalent.

Footnote 2. Suitable as Motor Disconnect – 10KA @ 600VAC, 60A max. Class J Fuse or 100A max. Ferraz Shawmut HSJ Fuse.

CATALOG NO.	PHASE	POLE
7802MD or 7842MD	1	2
7803MD or 7843MD	3	3

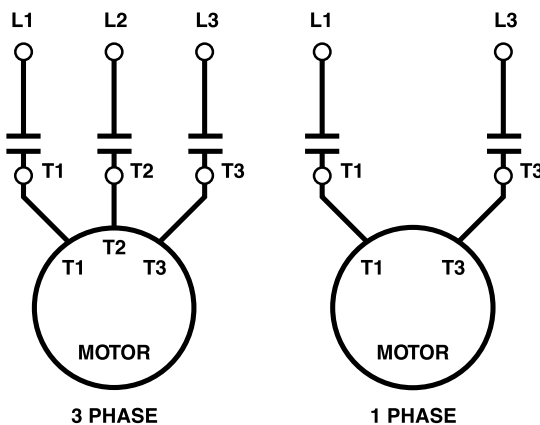

RATINGS

RESISTANCE				
7802MD / 7803MD		30 AMP	600 VAC MAX.	
7842MD / 7843MD		40 AMP	600 VAC MAX.	
MANUAL MOTOR CONTROLLER				
VAC	30A		40A	
	1 PHASE HP	3 PHASE HP	1 PHASE HP	3 PHASE HP
120	2	3	2	3
240	3	7.5	5	7.5
480	7.5	10	10	15
600	10	20	15	20

USE 60 / 75°C WIRING
TORQUE TERMINAL SCREWS
TO 16 IN. LBS.



NO ALUMINUM

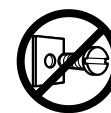

DO NOT
REMOVE SCREWS
FROM 30A DEVICES

SWITCHES

Manual Controllers 60A NEMA 3R Manual Controller 20 & 30A 1ø



7863R

Features

- High horsepower rating, up to 3 HP for heavy duty applications.
- Compact design provides ease of installation.
- Box lug terminals.
- Single piece moveable and stationary contact arms with oversized silver cadmium buttons provides excellent continuity and long life.
- Made in USA.
- Wire pockets and thick wall arc barriers.
- Cold-rolled steel NEMA 3R enclosure with polyester urethane finish conforms to OSHA lockout requirements.
- Type 3R enclosure has 2-1/2", 3/4" and 1" concentric knockouts on bottom.
- Accepts #4 AWG.
- cULus listed.
- Slotted opening on enclosure allows for lock-out, tag-out functionality

CATALOG NUMBER	DESCRIPTION	RATING			
		A.	VAC	HP	VAC
DOUBLE POLE MANUAL MOTOR CONTROLLER					
7862R	Double Pole AC Manual Motor Controller in a NEMA 3R Enclosure	60	600 max.	3 5 15 15	120 240 480 600
7862	Double Pole AC Manual Motor Controller	60	600 max	Same as 7862R	
THREE POLE MANUAL MOTOR CONTROLLER					
7863R	Three Pole AC Manual Motor Controller in a NEMA 3R Enclosure	60	600 max.	5 10 20 30	120 240 480 600
7863	Three Pole AC Manual Motor Controller	60	600 max	Same as 7863R	
NEMA 3R ENCLOSURE					
7860	NEMA 3R Enclosure for 7862 & 7863				

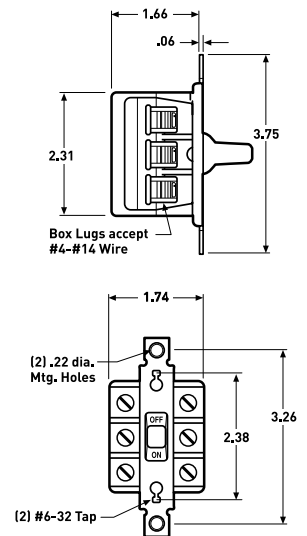

Horsepower Rated Switches

Features

- Oversize silver contacts for long life and better heat dissipation.
- Single phase switches are side wired with #14 AWG - #10 AWG copper or copper-clad conductors.
- Shallow design for ease of installation.
- 2-3/4" hubs (HP30EX).

CATALOG NUMBER	DESCRIPTION	RATING			
		A.	VAC	HP	VAC
DOUBLE POLE, SINGLE PHASE					
PS20AC2HP	Double Pole, Single Phase AC Manual Motor Starting Switch (No overload protection)	20	120/277	1 2	120 240
PS30AC2HP	Double Pole, Single Phase AC Manual Motor Starting Switch (No overload protection)	30	120/277	1 2	120 240
HP30EX	PS30AC2HP in a NEMA 7 & 9 Enclosure for Hazardous Locations Class I - Groups C, D; Class II - Groups E, F, G	Same as PS30AC2HP			

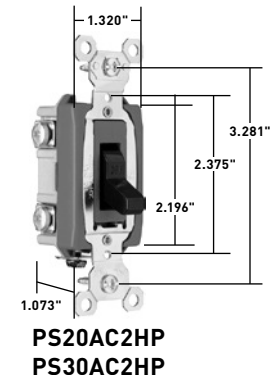

SWITCHES

Manual Controllers 15, 20 & 30A, 120/277VAC – Maintained Contact
 15, 20 & 30A, 120/277VAC – Momentary Contact

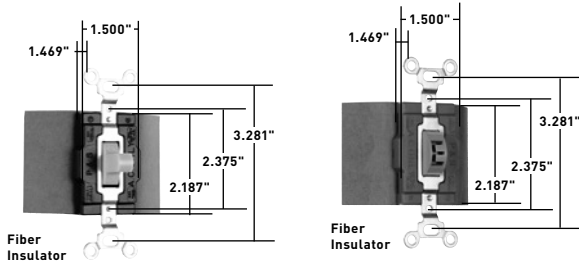

Maintained and Momentary Contact

Locking

Applications

For ON-OFF control of motors on small machine tools, pumps, fans and air conditioning equipment that require heavy-duty AC Double Throw Center OFF controls.

Features

- Oversized silver alloy contacts for long life and better heat dissipation.
- Side wired terminals accept #14 AWG – #10 AWG copper or copper-clad conductors.
- Fiber terminal insulation barriers standard.
- Can be mounted in standard device boxes or in NEMA 1 sheet steel enclosures.
- Bodies, covers and toggles molded of durable nylon.
- Single Pole-Double Throw and Double Pole-Double Throw.
- Locking Switches supplied with one 1498 NT key.
- Normally open.

CATALOG NUMBER		RATING		
S.P.D.T.	D.P.D.T.	A.	VAC	COLOR
MAINTAINED CONTACT THREE POSITION – TWO CIRCUIT, CENTER OFF				
1221I	1222I	15	120/277	Ivory
1221W	1222W	15	120/277	White
1221	1222	15	120/277	Brown
1221LA		15	120/277	Light Almond
1221L	1222L	15	120/277	Locking
1225I	1226I	20	120/277	Ivory
1225W	1226W	20	120/277	White
1225	1226	20	120/277	Brown
1225GRY		20	120/277	Gray
1225LA		20	120/277	Light Almond
1225L	1226L	20	120/277	Locking
1227I	1228I	30	120/277	Ivory
1227	1228	30	120/277	Brown
MAINTAINED CONTACT EITHER DIRECTION TWO POSITION, NO CENTER OFF				
1275	1276	30	120/277	Brown
MOMENTARY CONTACT EITHER DIRECTION THREE POSITION, CENTER OFF				
1250I		15	120/277	Ivory
1250W		15	120/277	White
1250		15	120/277	Brown
1250GRY		15	120/277	Gray
1250RED		15	120/277	Red
1250L		15	120/277	Locking
1251I		20	120/277	Ivory
1251W		20	120/277	White
1251		20	120/277	Brown
1251GRY		20	120/277	Gray
1251RED		20	120/277	Red
1251LA		20	120/277	Light Almond
1251L		20	120/277	Locking
	1256I	30	120/277	Ivory
	1256W	30	120/277	White
1255		30	120/277	Brown
1255L	1256L	30	120/277	Locking

CATALOG NUMBER	DESCRIPTION
LOCK SWITCH REPLACEMENT KEYS	
1498	Fits switches manufactured before 1976.
1498NT	Fits switches manufactured between 1976-present.

HP Conversion Table

1221 SERIES	
15 Amp	1/2 Horsepower at 120VAC 2 Horsepower at 240VAC
20 Amp	1 Horsepower at 120VAC 2 Horsepower at 240VAC
30 Amp	2 Horsepower at 120VAC 2 Horsepower at 240VAC
1250 SERIES	
15 Amp	1/2 Horsepower at 120VAC 2 Horsepower at 240VAC
20 Amp	1 Horsepower at 120VAC 2 Horsepower at 240VAC
30 Amp	2 Horsepower at 120VAC 2 Horsepower at 240VAC

DEVICES & WALL PLATES

Color Selection Chart

Devices & Plastic Wall Plate Colors

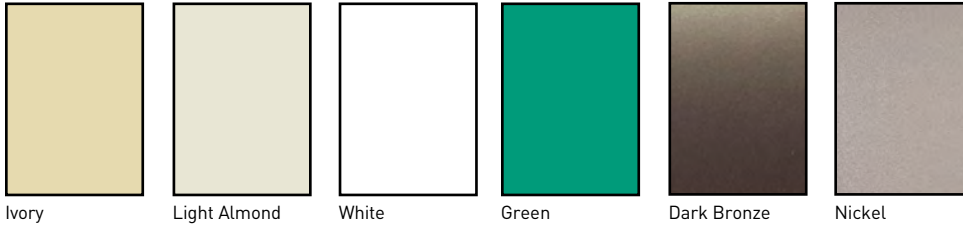

Ivory Light Almond White Green Dark Bronze Nickel

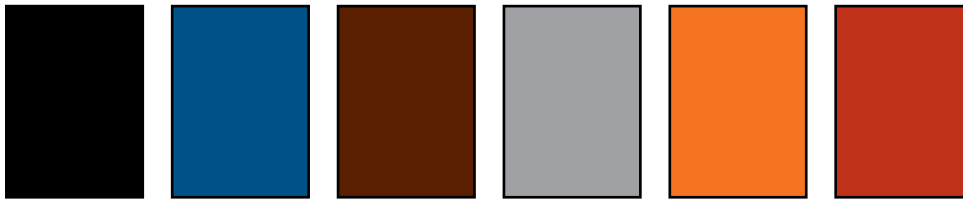

Black Blue Brown Gray Orange Red

See specific device and wall plate catalog charts for particular color availabilities.

Metal Wall Plates

Metal Finish



Aluminum Polished Brass Stainless Steel Brushed Bronze Chrome

Custom Metal Wall Plates Paint Finish Colors

Paint Color

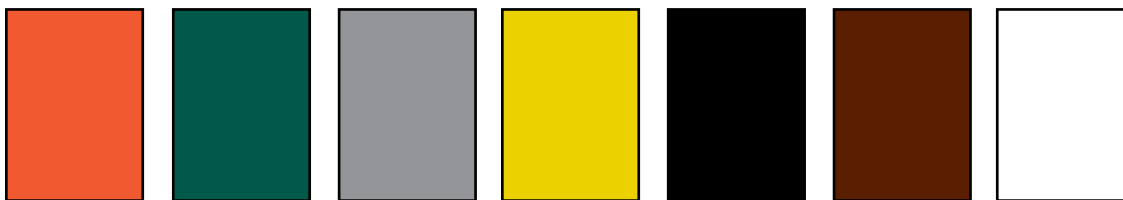

Orange Green Gray Yellow Glossy Black Brown White



Primer Red Pink Flat Black Ivory Light Almond Blue

To order custom metal wall plates, see Pages S-40 – S-44.

For additional colors consult factory.

SWITCHES

A-30

STRAIGHT BLADE RECEPTACLES

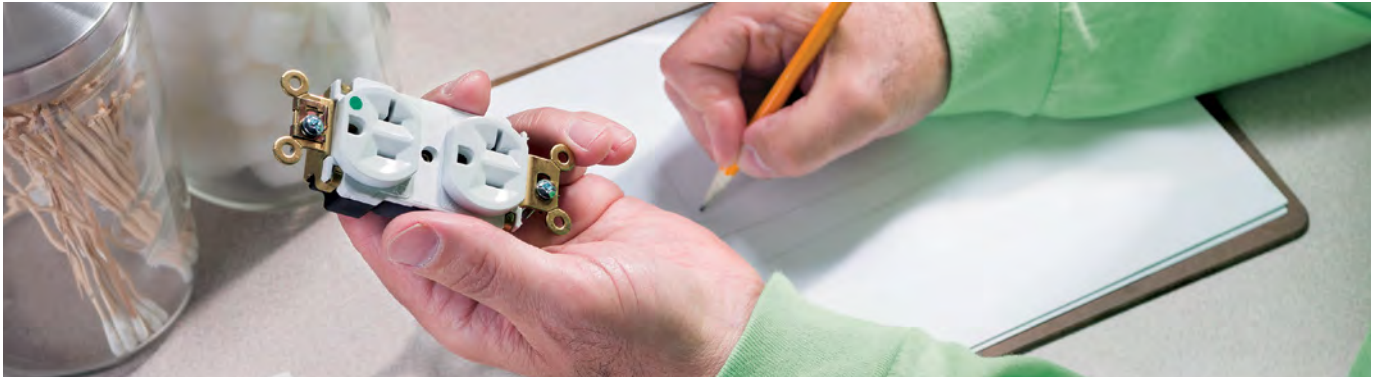

CONNECT WITH THE FUTURE

In the world of commercial wiring device installation, it's all about flexibility. For years now, PlugTail® electrical wiring devices have been providing that flexibility in commercial buildings everywhere. Easy to install, change out and upgrade, PlugTail allows you to continuously reconfigure to

meet a building's electrical requirements as the space transforms – without the time and expense of rewiring.

It's a cost-effective, code-compliant, proven way to keep your customers connected to the future, while securing your reputation as a forward-thinking electrical contractor.

Connect with the product line that keeps growing.

From sensors to switches, standard and controlled receptacles to surge protection devices. The constantly growing PlugTail family has you covered on every conceivable commercial job:

- Devices install in less than a minute
- No preparing, stripping, looping or taping
- Meet NEC® and Energy Code requirements
- Makes changeouts and upgrades quick and easy

Happier installers. Happier customers. Because PlugTail installation's a lot easier on the knees and fingers, installers benefit. And because it makes it easy and affordable for customers to transform their building layouts without expensive rewiring, they're happier, too.

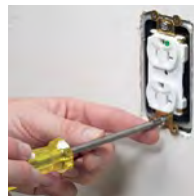

Featured Products

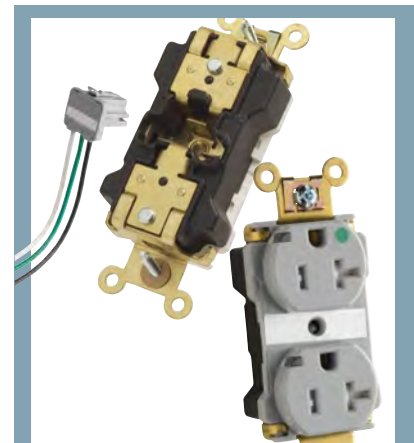

PLUGTAIL®
POWER INDICATOR
RECEPTACLES

B-5



PLUGTAIL® HOSPITAL
GRADE NIGHT LIGHT
GFCI

B-65

STRAIGHT BLADE RECEPTACLES

Table of Contents

PlugTail® Extra Heavy-Duty Specification Grade Receptacles	B-3	Heavy-Duty Hospital & Specification Grade Decorator Receptacles	B-42
Extra Heavy-Duty Hospital Grade Receptacles	B-7	TradeMaster® Tamper-Resistant Receptacles	B-49
Industrial Extra Heavy-Duty Specification Grade Receptacles	B-9	radiant® Tamper-Resistant Receptacles	B-50
Heavy-Duty Specification Grade Receptacles	B-11	Weather-Resistant Receptacles	B-51
Heavy-Duty Hospital Grade Receptacles	B-12	radiant® Receptacles	B-52
Heavy-Duty Hospital Grade Compact Design Receptacles	B-13	TradeMaster® Receptacles	B-53
Heavy-Duty Hospital Grade Tamper-Resistant Compact Design Receptacles	B-14	radiant® Night Lights, Hallway Lights & Combination Devices	B-54
PlugTail® Specification Grade Receptacles	B-15	radiant® Tamper-Resistant GFCIs	B-55
PlugTail® Tamper-Resistant Specification & Hospital Grade Receptacles	B-17	Hospital Grade Tamper-Resistant GFCIs	B-56
PlugTail® Hospital Grade Receptacles	B-18	radiant® Specification Grade GFCIs	B-57
PlugTail® Specification Grade Receptacles Split Circuit	B-19	Hospital Grade GFCIs	B-58
PlugTail® Tamper-Resistant Hospital Grade Decorator Receptacles	B-20	radiant® Tamper-Resistant Switch/GFCIs	B-59
Plug Load Controllable Decorator Receptacles	B-21	radiant® & Hospital Grade Night Light/GFCIs	B-60
Plug Load Controllable Receptacles	B-22	radiant® Weather-Resistant GFCIs	B-61
Hard Use Specification Grade Receptacles	B-23	PlugTail® Specification Grade GFCIs	B-62
Construction Specification Grade Receptacles	B-24	PlugTail® Hospital Grade GFCIs	B-63
Commercial Specification Grade Receptacles	B-25	PlugTail® Spec & Hospital Grade Tamper-Resistant GFCIs	B-64
Hospital Grade Single Receptacles	B-26	PlugTail® Spec & Hospital Grade Tamper-Resistant Night Light/GFCIs	B-65
Heavy-Duty Specification Grade Single Receptacles	B-27	NAFTA-Compliant GFCIs	B-66
Specification Grade Single Receptacles	B-28	NAFTA-Compliant Hospital Grade GFCIs	B-67
Tamper-Resistant Receptacles	B-29	NAFTA-Compliant PlugTail® GFCIs	B-68
Weather-Resistant Receptacles	B-34	NAFTA-Compliant PlugTail® Hospital Grade GFCIs	B-69
Isolated Ground Receptacles	B-35	radiant® RoHS-Compliant GFCIs	B-70
radiant® USB Chargers with Tamper-Resistant Receptacles	B-37	Surge Protective Spec Grade, Hospital Grade & PlugTail® Receptacles	B-71
Fed Spec & Hospital Grade USB Chargers	B-38	Quad Receptacles & Accessories	B-75
PlugTail® Tamper-Resistant Duplex Receptacles	B-40	Dust & Moisture Resistant & Clock Hanger Receptacles	B-77
PlugTail® Decorator Receptacles	B-41	Power Outlet Receptacles & Plugs	B-78
		Miscellaneous Configurations	B-81
		Power & Surge Protection Strips & Specifications	B-82

STRAIGHT BLADE RECEPTACLES

PlugTail® Extra Heavy-Duty Specification Grade Receptacles

PT5362AW Duplex Receptacles

- A. Auto-ground clip** ensures positive ground.
- B. Exclusive patented feature, circuit label on face** allows permanent circuit identification.
- C. .036 inch thick, brass, triple-wipe power contacts** for lasting retention.
- D. Strap tabs wrap around and lock down on face** to prevent strap from separating from face and back body.
- E. No exposed terminals** create a finger-safe application before, during, and after installation.
- F. Built-in connector** features large brass terminal blades to ensure consistent, reliable electrical connections.
- G. Large crimped and welded brass contacts** snugly terminate on device blade terminals.
- H. Ultrasonically welded polycarbonate connector housing** secures terminations and conductors in a UL Listed, finger safe housing. Audible snapping latch assures connection, allows release.
- I. Exclusive patented feature, circuit label on back** allows permanent circuit identification.
- J. Pre-stripped connector leads** fasten to conductors, easier than standard pigtails.

Two drive screws anchor strap to back body and face.

Tamper-resistant version features dual mechanical shutter system to help prevent insertion of foreign objects.

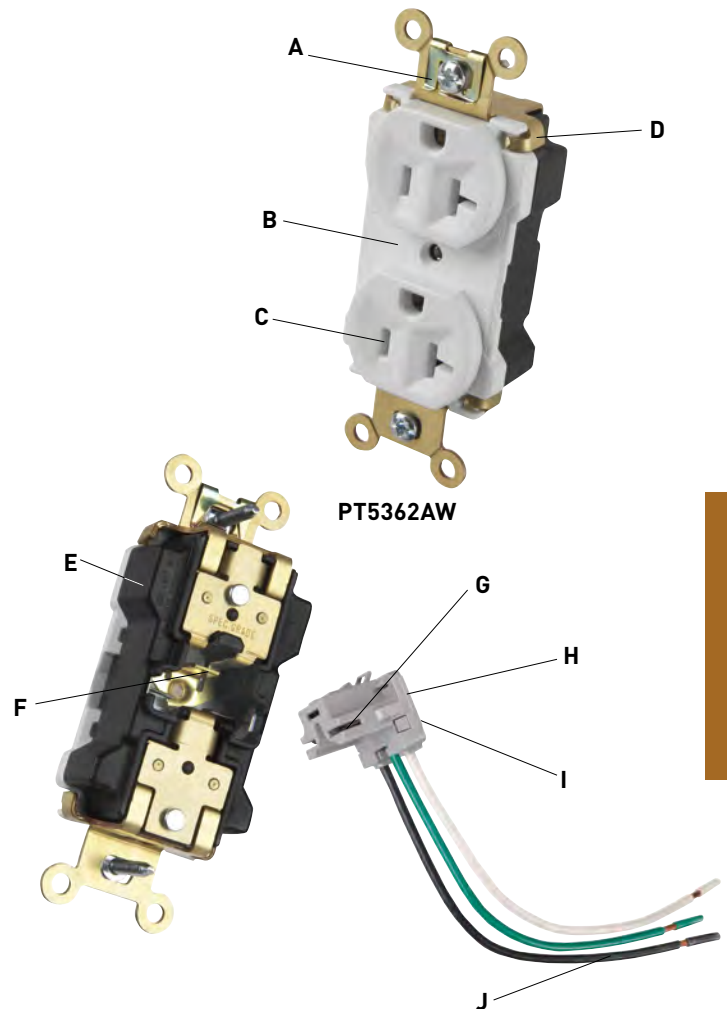

STRAIGHT BLADE RECEPTACLES

PlugTail® Extra Heavy-Duty Specification Grade Receptacles 15 & 20A, 125V

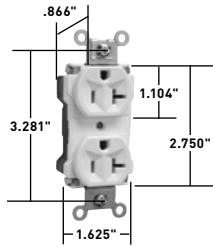

PT5362AW

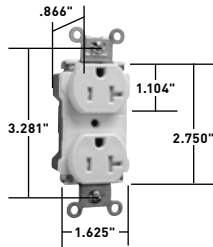

PTTR63W

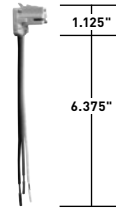

PTR63STR



PTR63STRBP



PTR63STRG

CATALOG NUMBER	RATING		COLOR	NEMA CONFIG. NO.	3rd PARTY COMPLIANCE	
	A.	V.			cUL ^{us} UL498	FSUL WC596
DUPLEX RECEPTACLES						
PT5262AI	15	125	Ivory	5-15R	•	•
PT5262AW	15	125	White	5-15R	•	•
PT5262A	15	125	Brown	5-15R	•	•
PT5262AGRY	15	125	Gray	5-15R	•	•
PT5262ABK	15	125	Black	5-15R	•	•
PT5262ALA	15	125	Light Almond	5-15R	•	•
PT5362AI	20	125	Ivory	5-20R	•	•
PT5362AW	20	125	White	5-20R	•	•
PT5362A	20	125	Brown	5-20R	•	•
PT5362AGRY	20	125	Gray	5-20R	•	•
PT5362ABK	20	125	Black	5-20R	•	•
PT5362ARED	20	125	Red	5-20R	•	•
PT5362ALA	20	125	Light Almond	5-20R	•	•
TAMPER-RESISTANT DUPLEX RECEPTACLES						
PTTR62I	15	125	Ivory	5-15R	•	•
PTTR62W	15	125	White	5-15R	•	•
PTTR63I	20	125	Ivory	5-20R	•	•
PTTR63W	20	125	White	5-20R	•	•
PTTR63	20	125	Brown	5-20R	•	•
PTTR63GRY	20	125	Gray	5-20R	•	•
PTTR63BK	20	125	Black	5-20R	•	•
PTTR63LA	20	125	Light Almond	5-20R	•	•

2 Pole, 3 Wire



NEMA 5-15R



NEMA 5-20R

CATALOG NUMBER	WIRE TYPE	CONNECTOR HEAD	WIRE LENGTH
PLUGTAIL CONNECTORS - RIGHT ANGLE			
PLUGTAIL CONNECTORS - RIGHT ANGLE			
PTRA6SOL	Solid		6"
PTRA6STR	Stranded		6"
PTRA6SOLB25	Solid		25"
PTRA6STRB25	Stranded		25"
NAFTA-COMPLIANT PLUGTAIL CONNECTORS - RIGHT ANGLE			
PTRA6SOLNA	Solid		6"
PTRA6STRNABL	Stranded	Blue	6"
PTRA6STRNAOR	Stranded	Orange	6"
PTRA6STRNARE	Stranded	Red	6"

CATALOG NUMBER	WIRE TYPE	WIRE LENGTH
PLUGTAIL CONNECTORS - RIGHT ANGLE WITH WAGO CONNECTORS		
PTRA6SOLBP	Solid	6"
PTRA6STRBP	Stranded	6"
PLUGTAIL CONNECTORS - RIGHT ANGLE WITH GROUND SCREW		
PTRA6SOLG	Solid	6"
PTRA6STRG	Stranded	6"

CATALOG NUMBER	DESCRIPTION
P&S PLUGTAIL® TESTER	
PTTESTER	Red PlugTail Tester for Receptacles and Tails

For Bulk Packaging Solutions consult factory.

NAFTA-Compliant PlugTail Connectors are ideal for use on projects subject to the provisions of the Buy American Act.

STRAIGHT BLADE RECEPTACLES

STRAIGHT BLADE RECEPTACLES

PlugTail® Extra Heavy-Duty Hospital Grade Receptacles 15 & 20A, 125V

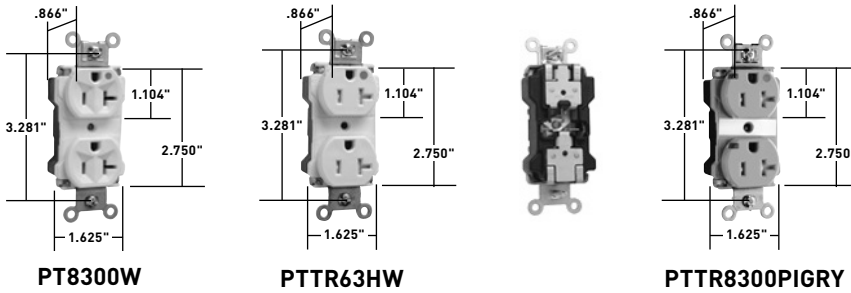

Features

- Exclusive patented feature, circuit label on face allows permanent circuit identification.
- .036 inch thick, brass, triple-wipe power contacts for lasting retention.
- Strap tabs wrap around and lock down on face to prevent strap from separating from face and back body.
- No exposed terminals create a finger safe application before, during, and after installation.
- Built-in connector features large brass terminal blades to ensure consistent, reliable electrical connections.
- Crimped and welded contacts.
- Ultrasonically welded polycarbonate connector housing secures terminations and conductors in a UL Listed, finger safe housing.
- Large brass contacts snugly terminate on device blade terminals.
- Pre-stripped connector leads fasten to conductors, easier than standard pigtails.
- Auto-ground clip assures positive ground.
- Tamper-resistant version features dual mechanical shutter system to help prevent insertion of foreign objects.

CATALOG NUMBER	RATING		COLOR	NEMA CONFIG. NO.	3rd PARTY COMPLIANCE	
	A.	V.			cUL ^{us} UL498	FSUL WC596
DUPLEX RECEPTACLES						
PT8200I	15	125	Ivory	5-15R	•	•
PT8200W	15	125	White	5-15R	•	•
PT8200GRY	15	125	Gray	5-15R	•	•
PT8200BK	15	125	Black	5-15R	•	•
PT8200RED	15	125	Red	5-15R	•	•
PT8200LA	15	125	Light Almond	5-15R	•	•
PT8200BL	15	125	Blue	5-15R	•	•
PT8300I	20	125	Ivory	5-20R	•	•
PT8300W	20	125	White	5-20R	•	•
PT8300	20	125	Brown	5-20R	•	•
PT8300GRY	20	125	Gray	5-20R	•	•
PT8300BK	20	125	Black	5-20R	•	•
PT8300RED	20	125	Red	5-20R	•	•
PT8300LA	20	125	Light Almond	5-20R	•	•
PT8300BL	20	125	Blue	5-20R	•	•
TAMPER-RESISTANT DUPLEX RECEPTACLES						
PTTR62HI	15	125	Ivory	5-15R	•	•
PTTR62HW	15	125	White	5-15R	•	•
PTTR62HBK	15	125	Black	5-15R	•	•
PTTR62HRED	15	125	Red	5-15R	•	•
PTTR63HI	20	125	Ivory	5-20R	•	•
PTTR63HW	20	125	White	5-20R	•	•
PTTR63H	20	125	Brown	5-20R	•	•
PTTR63HGRY	20	125	Gray	5-20R	•	•
PTTR63HBK	20	125	Black	5-20R	•	•
PTTR63HRED	20	125	Red	5-20R	•	•
PTTR63HLA	20	125	Light Almond	5-20R	•	•
POWER INDICATOR EXTRA HEAVY-DUTY PLUGTAIL® DUPLEX RECEPTACLES						
PTTR8200PI	15	125	Brown	5-15R	•	•
PTTR8200PIW	15	125	White	5-15R	•	•
PTTR8200PILA	15	125	Light Almond	5-15R	•	•
PTTR8200PII	15	125	Ivory	5-15R	•	•
PTTR8200PIRED	15	125	Red	5-15R	•	•
PTTR8200PIGRY	15	125	Gray	5-15R	•	•
PTTR8300PI	20	125	Brown	5-20R	•	•
PTTR8300PIW	20	125	White	5-20R	•	•
PTTR8300PILA	20	125	Light Almond	5-20R	•	•
PTTR8300PII	20	125	Ivory	5-20R	•	•
PTTR8300PIRED	20	125	Red	5-20R	•	•
PTTR8300PIGRY	20	125	Gray	5-20R	•	•

2 Pole, 3 Wire

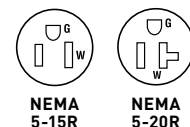

For Bulk Packaging Solutions consult factory.

For PlugTail Connectors, see Page B-4.

STRAIGHT BLADE RECEPTACLES

PlugTail® Extra Heavy-Duty Hospital Grade Illuminated Receptacles 15 & 20A, 125V

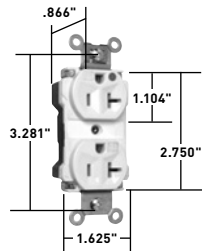

PT8300ILLA



Illuminated face indicates power to receptacle and makes it easy to identify receptacle in dark applications.



PTTESTER

Features

- Molded-in "IL" markings on face of product.
- Illuminated face indicates power to receptacle and makes it easy to identify receptacle in dark applications.
- Exclusive patented feature, circuit label on face allows permanent circuit identification.
- .036 inch thick, brass, triple-wipe power contacts for lasting retention.
- Strap tabs wrap around and lock down on face to prevent strap from separating from face and back body.
- No exposed terminals create a finger safe application before, during, and after installation.
- Built-in connector features large brass terminal blades to ensure consistent, reliable electrical connections.
- Crimped and welded contacts.
- Ultrasonically welded polycarbonate connector housing secures terminations and conductors in a UL Listed, finger safe housing.
- Large brass contacts snugly terminate on device blade terminals.
- Pre-stripped connector leads fasten to conductors, easier than standard pigtails.
- Auto-ground clip assures positive ground.

CATALOG NUMBER	RATING		COLOR	NEMA CONFIG. NO.	3rd PARTY COMPLIANCE	
	A.	V.			cULus UL498	FSUL WC596
ILLUMINATED DUPLEX RECEPTACLES						
PT8200ILI	15	125	Ivory	5-15R	•	•
PT8200ILW	15	125	White	5-15R	•	•
PT8200ILGRY	15	125	Gray	5-15R	•	•
PT8200ILBK	15	125	Black	5-15R	•	•
PT8200ILRED	15	125	Red	5-15R	•	•
PT8200ILLA	15	125	Light Almond	5-15R	•	•
PT8300ILI	20	125	Ivory	5-20R	•	•
PT8300ILW	20	125	White	5-20R	•	•
PT8300IL	20	125	Brown	5-20R	•	•
PT8300ILGRY	20	125	Gray	5-20R	•	•
PT8300ILRED	20	125	Red	5-20R	•	•
PT8300ILLA	20	125	Light Almond	5-20R	•	•

2 Pole, 3 Wire

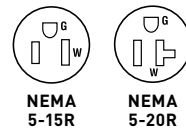

Features

- Ensures proper connections and power presence at both rough-in and device-out stages during P&S PlugTail Device installation.
- Fast, easy identification of circuit connections.
- Easy-to-see indicator lights.
- Sturdy construction for long-term dependability.
- Helps prevent call backs.
- Ensures proper wiring.

CATALOG NUMBER	DESCRIPTION
P&S PLUGTAIL® TESTER	
PTTESTER	Red PlugTail Tester for Receptacles and Tails



For PlugTail Connectors, see Page B-4.

For Bulk Packaging Solutions consult factory.

STRAIGHT BLADE RECEPTACLES

Extra Heavy-Duty Hospital Grade Receptacles 15 & 20A, 125V; 20A, 250V

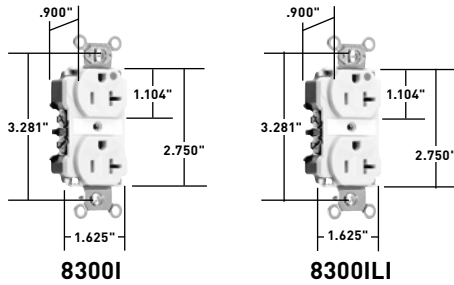

Features

- One-piece nickel-plated brass mounting strap with integral ground.
- Strap tabs wrap around and lock down on face to prevent strap from separating from face and back body.
- Two drive screws anchor strap to back body and face.
- Exclusive patented feature, circuit label on face allows permanent circuit identification.
- .040 inch thick, nickel-plated brass, triple-wipe power contacts for lasting retention.
- Easily accessed break-off, line-contact connecting tab for fast, easy split-circuit wiring.
- Impact-resistant nylon face and back body.
- Oversized #10 deep tri-drive head brass terminal and ground screws.
- Exclusive patented feature, external screw-pressure-plate back wire clamp on ground terminal for faster, easier installation.
- External nickel-plated screw-pressure-plate back wire clamps with #10 brass terminal screws for visual assurance of a good connection.
- Line terminals accept #14 – #10 AWG stranded or solid copper clad conductors.
- Auto-ground clip assures positive ground.
- Illuminated version features exclusive LED lamp with solder connection for long durable life (10-12 years).

CATALOG NUMBER	RATING		COLOR	NEMA CONFIG. NO.	3rd PARTY COMPLIANCE		
	A.	V.			UL ^{US} UL498	FSUL WC596	CSA C22.2 No. 42
DUPLIX RECEPTACLES BACK & SIDE WIRE							
8200I	15	125	Ivory	5-15R	•	•	•
8200W	15	125	White	5-15R	•	•	•
8200	15	125	Brown	5-15R	•	•	•
8200GRY	15	125	Gray	5-15R	•	•	•
8200BK	15	125	Black	5-15R	•	•	•
8200RED	15	125	Red	5-15R	•	•	•
8200LA	15	125	Light Almond	5-15R	•	•	•
8300I	20	125	Ivory	5-20R	•	•	•
8300W	20	125	White	5-20R	•	•	•
8300	20	125	Brown	5-20R	•	•	•
8300GRY	20	125	Gray	5-20R	•	•	•
8300BK	20	125	Black	5-20R	•	•	•
8300RED	20	125	Red	5-20R	•	•	•
8300LA	20	125	Light Almond	5-20R	•	•	•
8800I	20	250	Ivory	6-20R	•	•	•
8800W	20	250	White	6-20R	•	•	•
8800	20	250	Brown	6-20R	•	•	•
8800GRY	20	250	Gray	6-20R	•	•	•
8800BK	20	250	Black	6-20R	•	•	•
8800LA	20	250	Light Almond	6-20R	•	•	•
8800RED	20	250	Red	6-20R	•	•	•
LED ILLUMINATED FACE DUPLIX RECEPTACLES BACK & SIDE WIRE							
8200ILI	15	125	Ivory	5-15R	•	•	•
8200ILW	15	125	White	5-15R	•	•	•
8200ILRED	15	125	Red	5-15R	•	•	•
8300ILI	20	125	Ivory	5-20R	•	•	•
8300ILW	20	125	White	5-20R	•	•	•
8300ILGRY	20	125	Gray	5-20R	•	•	•
8300ILRED	20	125	Red	5-20R	•	•	•
8300ILLA	20	125	Light Almond	5-20R	•	•	•

For Bulk Packaging Solutions consult factory.

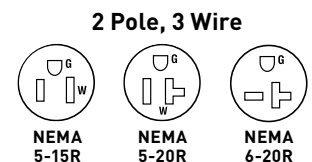

STRAIGHT BLADE RECEPTACLES

STRAIGHT BLADE RECEPTACLES

Extra Heavy-Duty Hospital Grade MRI Receptacles 15 & 20A, 125V

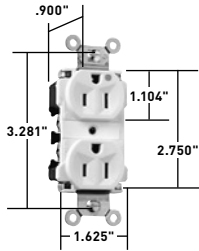

8200LAMRI

Receptacles designed expressly for MRI applications – We build these exclusive P&S receptacles with no ferrous metal, so they are perfect for high-magnetic-field environments such as magnetic-resonance imaging (MRI) suites. With the same basic design as our standard Extra Heavy-Duty Receptacles, they are extremely durable.

Features

- Exclusive patented feature, circuit label on face allows permanent circuit identification.
- Extra heavy-duty, one-piece nickel-plated brass mounting strap with integral ground for superior structural integrity and long-term performance.
- .036 inch thick, brass, triple-wipe power contacts for lasting retention.
- Strap tabs wrap around and lock down on face to prevent strap from separating from face and back body.
- Easily accessed break-off, line-contact connecting tab for fast, easy split-circuit wiring.
- Exclusive patented feature, external screw-pressure-plate back wire clamp on ground terminal for faster, easier installation.
- External screw-pressure-plate back wire clamps with #10 brass terminal screws for visual assurance of a good connection.
- Auto-ground clip assures positive ground.

CATALOG NUMBER	RATING		COLOR	NEMA CONFIG. NO.	3rd PARTY COMPLIANCE		
	A.	V.			UL498	FSUL WC596	C22.2 No. 42
HOSPITAL GRADE DUPLEX RECEPTACLES BACK & SIDE WIRE							
8200WMRI	15	125	White	5-15R	•	•	•
8200REDMRI	15	125	Red	5-15R	•	•	•
8200LAMRI	15	125	Light Almond	5-15R	•	•	•
8300IMRI	20	125	Ivory	5-20R	•	•	•
8300WMRI	20	125	White	5-20R	•	•	•
8300GRYMRI	20	125	Gray	5-20R	•	•	•
8300REDMRI	20	125	Red	5-20R	•	•	•
8300LAMRI	20	125	Light Almond	5-20R	•	•	•

2 Pole, 3 Wire

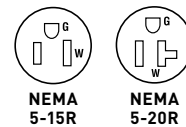

STRAIGHT BLADE RECEPTACLES

Industrial Extra Heavy-Duty Specification Grade Receptacles

5362AI

Industrial EHD Spec Grade Receptacles

- A. .036 inch thick, brass, triple-wipe power contacts** for lasting retention.
 - B. Exclusive patented feature, circuit label on face** allows permanent circuit identification.
 - C. Two drive screws anchor strap** to back body and face where abrupt removal torque is strongest.
 - D. Strap tabs wrap around and lock down on face** to prevent strap from separating from face and back body.
 - E. Exclusive, patented feature, external screw-pressure-plate back wire clamp on ground terminal** for faster, easier installation.
 - F. External screw-pressure-plate back wire clamps with #10 brass terminal screws** for visual assurance of a good connection.
 - G. Auto-ground clip** assures positive ground.
- Heavy-duty, one-piece brass strap** and integral ground for added strength and safety.

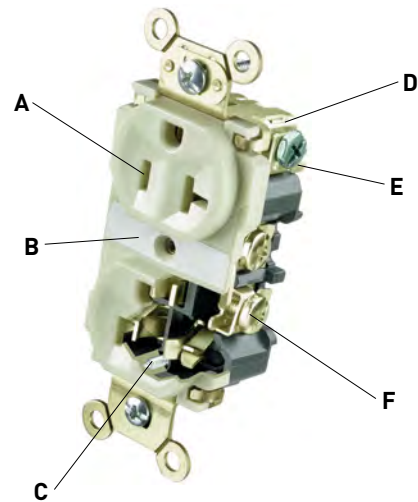

5362AI



STRAIGHT BLADE RECEPTACLES

Industrial Extra Heavy-Duty Specification Grade Receptacles 15 & 20A, 125 & 250V

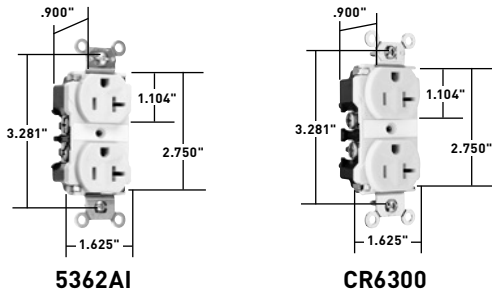

Features

- One-piece brass mounting strap with integral ground.
- Strap tabs wrap around and lock down on face to prevent strap from separating from face and back body.
- Two drive screws anchor strap to back body and face.
- Exclusive patented feature, circuit label on face allows permanent circuit identification.
- .036 inch thick, brass, triple-wipe power contacts for lasting retention.
- Easily accessed break-off, line-contact connecting tab for fast, easy split-circuit wiring.
- Impact-resistant nylon face and back body.
- Oversized #10 deep tri-drive head brass terminal and ground screws.
- Exclusive patented feature, external screw-pressure-plate back wire clamp on ground terminal for faster, easier installation.
- External screw-pressure-plate back wire clamps with #10 brass terminal screws for visual assurance of a good connection.
- Line terminals accept #14 – #10 AWG stranded or solid copper clad conductors.
- Auto-ground clip assures positive ground.
- Corrosion-resistant models have nickel-plated straps and contacts.

CATALOG NUMBER	RATING		COLOR	NEMA CONFIG. NO.	3rd PARTY COMPLIANCE		
	A.	V.			UL ^{US} 498	FSUL WC596	C22.2 No. 42
DUPLIX RECEPTACLES BACK & SIDE WIRE							
5262AI	15	125	Ivory	5-15R	•	•	•
5262AW	15	125	White	5-15R	•	•	•
5262A	15	125	Brown	5-15R	•	•	•
5262AGRY	15	125	Gray	5-15R	•	•	•
5262ARED	15	125	Red	5-15R	•	•	•
5262ALA	15	125	Light Almond	5-15R	•	•	•
5362AI	20	125	Ivory	5-20R	•	•	•
5362AW	20	125	White	5-20R	•	•	•
5362A	20	125	Brown	5-20R	•	•	•
5362AGRY	20	125	Gray	5-20R	•	•	•
5362ABK	20	125	Black	5-20R	•	•	•
5362ARED	20	125	Red	5-20R	•	•	•
5362ALA	20	125	Light Almond	5-20R	•	•	•
5362ABL	20	125	Blue	5-20R	•	•	•
5662AI	15	250	Ivory	6-15R	•	•	•
5662AW	15	250	White	6-15R	•	•	•
5662A	15	250	Brown	6-15R	•	•	•
5662AGRY	15	250	Gray	6-15R	•	•	•
5662ABK	15	250	Black	6-15R	•	•	•
5662ARED	15	250	Red	6-15R	•	•	•
5862AI	20	250	Ivory	6-20R	•	•	•
5862AW	20	250	White	6-20R	•	•	•
5862A	20	250	Brown	6-20R	•	•	•
5862AGRY	20	250	Gray	6-20R	•	•	•
5862ABK	20	250	Black	6-20R	•	•	•
5862ARED	20	250	Red	6-20R	•	•	•
5862ALA	20	250	Light Almond	6-20R	•	•	•
CORROSION-RESISTANT RECEPTACLES BACK & SIDE WIRE							
CR6200	15	125	Yellow	5-15R	•	•	•
CR6300	20	125	Yellow	5-20R	•	•	•

2 Pole, 3 Wire

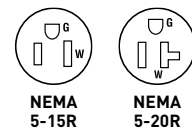

NEMA 5-15R

NEMA 5-20R

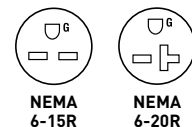

NEMA 6-15R

NEMA 6-20R

STRAIGHT BLADE RECEPTACLES

For Bulk Packaging Solutions consult factory.

STRAIGHT BLADE RECEPTACLES

Heavy-Duty Specification Grade Receptacles 15 & 20A, 125 & 250V

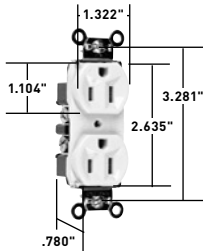

PS5262I

Features

- Heavy-duty, brass strap for added strength and ground conductivity.
- .032 inch thick, brass, triple-wipe power contacts for lasting retention.
- Strap tabs wrap around face to prevent strap from separating from face and back body.
- Easily accessed break-off, line-contact connecting tab for fast, easy split-circuit wiring.
- High strength nylon face.
- Internal screw-pressure-plate back and side wired to accept #14 and #10 AWG stranded or solid copper or copper-clad conductors. Eight back wire holes.
- Auto-ground clip assures positive ground.

CATALOG NUMBER	RATING		COLOR	NEMA CONFIG. NO.	3rd PARTY COMPLIANCE		
	A.	V.			UL [®] US UL498	FSUL WC596	CSA C22.2 No. 42
DUPLIX RECEPTACLES BACK & SIDE WIRE							
PS5262I	15	125	Ivory	5-15R	•	•	•
PS5262W	15	125	White	5-15R	•	•	•
PS5262	15	125	Brown	5-15R	•	•	•
PS5262GRY	15	125	Gray	5-15R	•	•	•
PS5262BK	15	125	Black	5-15R	•	•	•
PS5262RED	15	125	Red	5-15R	•	•	•
PS5262LA	15	125	Light Almond	5-15R	•	•	•
PS5362I	20	125	Ivory	5-20R	•	•	•
PS5362W	20	125	White	5-20R	•	•	•
PS5362	20	125	Brown	5-20R	•	•	•
PS5362GRY	20	125	Gray	5-20R	•	•	•
PS5362BK	20	125	Black	5-20R	•	•	•
PS5362RED	20	125	Red	5-20R	•	•	•
PS5362LA	20	125	Light Almond	5-20R	•	•	•
PS5362BL	20	125	Blue	5-20R	•	•	•
5662I	15	250	Ivory	6-15R	•	•	•
5662W	15	250	White	6-15R	•	•	•
5662	15	250	Brown	6-15R	•	•	•
5862I	20	250	Ivory	6-20R	•	•	•
5862W	20	250	White	6-20R	•	•	•
5862	20	250	Brown	6-20R	•	•	•
5862GRY	20	250	Gray	6-20R	•	•	•
5862BK	20	250	Black	6-20R	•	•	•
5862RED	20	250	Red	6-20R	•	•	•

2 Pole, 3 Wire

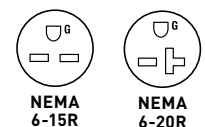
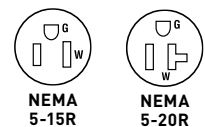

STRAIGHT BLADE RECEPTACLES

For Bulk Packaging Solutions consult factory.

All devices listed on this page conform to NEMA WD-1 and WD-6.

STRAIGHT BLADE RECEPTACLES

Heavy-Duty Hospital Grade Receptacles 15 & 20A, 125V

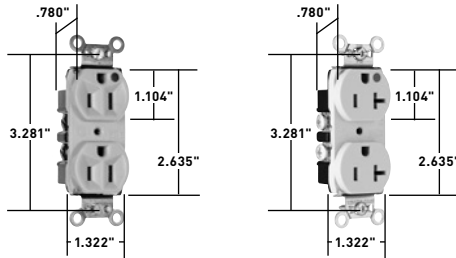

PS8200HI

PS8300HSI

Features

- Heavy-duty, brass strap for added strength and ground conductivity.
- .032 inch thick, brass, triple-wipe power contacts for lasting retention.
- Strap tabs wrap around face to prevent strap from separating from face and back body.
- Easily accessed break-off, line-contact connecting tab for fast, easy split-circuit wiring.
- Two drive screws anchor strap to back body and face.
- Tri-drive brass terminal screws. Internal screw-pressure-plate back and side wire capability. Two back wire holes for more wiring flexibility.
- Auto-ground clip assures positive ground.

CATALOG NUMBER	RATING		COLOR	NEMA CONFIG. NO.	3rd PARTY COMPLIANCE		
	A.	V.			UL498	FSUL WC596	C22.2 No. 42
DUPLEX RECEPTACLES BACK & SIDE WIRE							
PS8200HI	15	125	Ivory	5-15R	•	•	•
PS8200HW	15	125	White	5-15R	•	•	•
PS8200H	15	125	Brown	5-15R	•	•	•
PS8200HGRY	15	125	Gray	5-15R	•	•	•
PS8200HRED	15	125	Red	5-15R	•	•	•
PS8200HLA	15	125	Light Almond	5-15R	•	•	•
PS8300HI	20	125	Ivory	5-20R	•	•	•
PS8300HW	20	125	White	5-20R	•	•	•
PS8300H	20	125	Brown	5-20R	•	•	•
PS8300HGRY	20	125	Gray	5-20R	•	•	•
PS8300HRED	20	125	Red	5-20R	•	•	•
PS8300HLA	20	125	Light Almond	5-20R	•	•	•
SMOOTH FACE DUPLEX RECEPTACLES BACK & SIDE WIRE							
PS8200HSGRY	15	125	Gray	5-15R	•	•	•
PS8200HSLA	15	125	Light Almond	5-15R	•	•	•
PS8200HSI	15	125	Ivory	5-15R	•	•	•
PS8200HS	15	125	Brown	5-15R	•	•	•
PS8200HSRED	15	125	Red	5-15R	•	•	•
PS8200HSW	15	125	White	5-15R	•	•	•
PS8300HSGRY	15	125	Gray	5-15R	•	•	•
PS8300HSLA	15	125	Light Almond	5-15R	•	•	•
PS8300HSI	15	125	Ivory	5-15R	•	•	•
PS8300HS	15	125	Brown	5-15R	•	•	•
PS8300HSRED	15	125	Red	5-15R	•	•	•
PS8300HSW	15	125	White	5-15R	•	•	•

2 Pole, 3 Wire

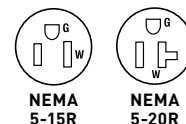

NEMA 5-15R

NEMA 5-20R

For Bulk Packaging Solutions consult factory.

STRAIGHT BLADE RECEPTACLES

STRAIGHT BLADE RECEPTACLES

Heavy-Duty Hospital Grade Compact Design Receptacles 15 & 20A, 125V; 20A, 250V

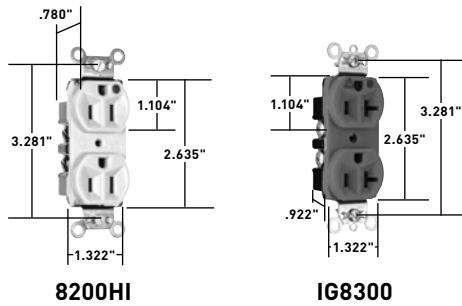

Features

- Impact-resistant nylon face.
- One-piece heat-treated triple-wipe brass power contacts.
- Easily accessible break-off line contact connecting tab for split circuit wiring.
- Terminal compartments isolated from each other for positive conductor containment.
- Corrosion-resistant, zinc-plated steel strap is locked in.
- Internal screw-pressure-plate back wire and side wire line terminals accept #14 – #10 AWG copper or copper-clad conductors.
- High strength thermoplastic back body.
- Back wire holes allow entry of conductor insulation partially into body but not into wiring compartment.
- Auto-ground clip assures positive ground.
- Compact design for easy installation.
- Tri-drive terminal and mounting screws.

CATALOG NUMBER	RATING		COLOR	NEMA CONFIG. NO.	3rd PARTY COMPLIANCE		
	A.	V.			UL498	FSUL WC596	C22.2 No. 42
DUPLIX RECEPTACLES – COMPACT DESIGN BACK & SIDE WIRE							
8200HI	15	125	Ivory	5-15R	•	•	•
8200HW	15	125	White	5-15R	•	•	•
8200H	15	125	Brown	5-15R	•	•	•
8200HGRY	15	125	Gray	5-15R	•	•	•
8200HRED	15	125	Red	5-15R	•	•	•
8200HLA	15	125	Light Almond	5-15R	•	•	•
8300HI	20	125	Ivory	5-20R	•	•	•
8300HW	20	125	White	5-20R	•	•	•
8300H	20	125	Brown	5-20R	•	•	•
8300HGRY	20	125	Gray	5-20R	•	•	•
8300HBK	20	125	Black	5-20R	•	•	•
8300HRED	20	125	Red	5-20R	•	•	•
8300HLA	20	125	Light Almond	5-20R	•	•	•
8300HOR	20	125	Orange	5-20R	•	•	•
ISOLATED GROUND DUPLEX RECEPTACLES BACK & SIDE WIRE							
IG8200I	15	125	Ivory	5-15R	•	•	•
IG8200	15	125	Orange	5-15R	•	•	•
IG8200RED	15	125	Red	W5-15R	•	•	•
IG8300I	20	125	Ivory	5-20R	•	•	•
IG8300W	20	125	White	5-20R	•	•	•
IG8300	20	125	Orange	5-20R	•	•	•
IG8300RED	20	125	Red	5-20R	•	•	•
IG8300LA	20	125	Light Almond	5-20R	•	•	•
IG8800	20	250	Orange	6-20R	•	•	•
IG8800LA	20	250	Light Almond	6-20R	•	•	•

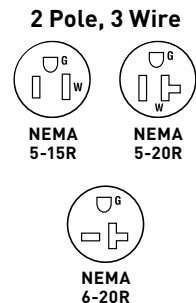

For Bulk Packaging Solutions consult factory.

All devices listed on this page conform to NEMA WD-1 and WD-6.

STRAIGHT BLADE RECEPTACLES

Heavy-Duty Hospital Grade Tamper-Resistant Compact Receptacles 15 & 20A, 125V

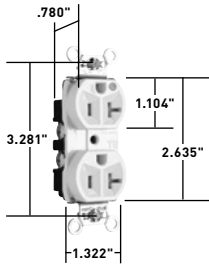

TR8300HW

Features

- Dual mechanical shutter system to help prevent insertion of foreign objects.
- .032-inch thick, brass, triple-wipe power contacts for lasting retention.
- Easily accessible break-off line contact connecting tab for split circuit wiring.
- Terminal compartments isolated from each other for positive conductor containment.
- Corrosion-resistant, zinc-plated steel strap is locked in.
- Internal screw-pressure-plate back wire and side wire line terminals accept #14 – #10 AWG copper or copper-clad conductors.
- High strength thermoplastic back body.
- Two back wire holes for more wiring flexibility.
- Auto-ground clip assures positive ground.
- Compact design for easy installation.
- Tri-drive terminal and mounting screws.

CATALOG NUMBER	RATING		COLOR	NEMA CONFIG. NO.	3rd PARTY COMPLIANCE		
	A.	V.			UL498	FSUL WC596	C22.2 No. 42
HOSPITAL GRADE TAMPER-RESISTANT DUPLEX RECEPTACLES BACK AND SIDE WIRE							
TR8200HI	15	125	Ivory	5-15R	•	•	•
TR8200HW	15	125	White	5-15R	•	•	•
TR8200HLA	15	125	Light Almond	5-15R	•	•	•
TR8200HGRY	15	125	Gray	5-15R	•	•	•
TR8200HRED	15	125	Red	5-15R	•	•	•
TR8200HBK	15	125	Black	5-15R	•	•	•
TR8300HI	20	125	Ivory	5-20R	•	•	•
TR8300HW	20	125	White	5-20R	•	•	•
TR8300HLA	20	125	Light Almond	5-20R	•	•	•
TR8300H	20	125	Brown	5-20R	•	•	•
TR8300HGRY	20	125	Gray	5-20R	•	•	•
TR8300HRED	20	125	Red	5-20R	•	•	•
TR8300HBK	20	125	Black	5-20R	•	•	•
TR8300HBL	20	125	Blue	5-20R	•	•	•

2 Pole, 3 Wire

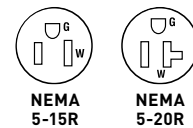

STRAIGHT BLADE RECEPTACLES

PlugTail® Specification Grade Receptacles

PTTR5362W and PT5362SCI
 PlugTail® Spec Grade Receptacles

- A. Auto-ground clip** assures positive ground.
 - B. .036 inch thick, brass, triple-wipe power contacts** for lasting retention.
 - C. Dual mechanical shutter system** to help prevent insertion of foreign objects.
 - D. Plated steel wrap strap design** for maximum durability and corrosion resistance.
 - E. Built-in connector** features large brass terminal blades to ensure consistent, reliable electrical connections.
 - F. Large brass contacts** snugly terminate on device blade terminals. Audible snapping latch assures connection, allows release.
 - G. Ultrasonically welded polycarbonate connector housing** secures terminations and conductors in a UL Listed, finger safe housing.
 - H. Pre-stripped connector leads** fasten to conductors, easier than standard pigtails.
 - I. No exposed terminals** create a finger safe application before, during, and after installation.
 - J. Built-in connector** features large brass terminal blades to ensure consistent, reliable electrical connections.
 - K. Large brass contacts** snugly terminate on device blade terminals. Audible snapping latch assures connection, allows release.
 - L. Exclusive patented feature, circuit label on back** allows permanent circuit identification.
 - M. Ultrasonically welded polycarbonate connector housing** secures terminations and conductors in a UL Listed, finger safe housing.
 - N. Pre-stripped connector leads** fasten to conductors, easier than standard pigtails.
 - O. Auto-ground clip** assures positive ground.
 - P. .036 inch thick, brass, triple-wipe power contacts** for lasting retention.
 - Q. Plated steel wrap strap design** for maximum durability and corrosion resistance.
 - R. Pre-wired with one welded pre-stripped wire lead** to facilitate switched receptacle circuit applications.
- Three drive screws anchor strap** to back body and face.

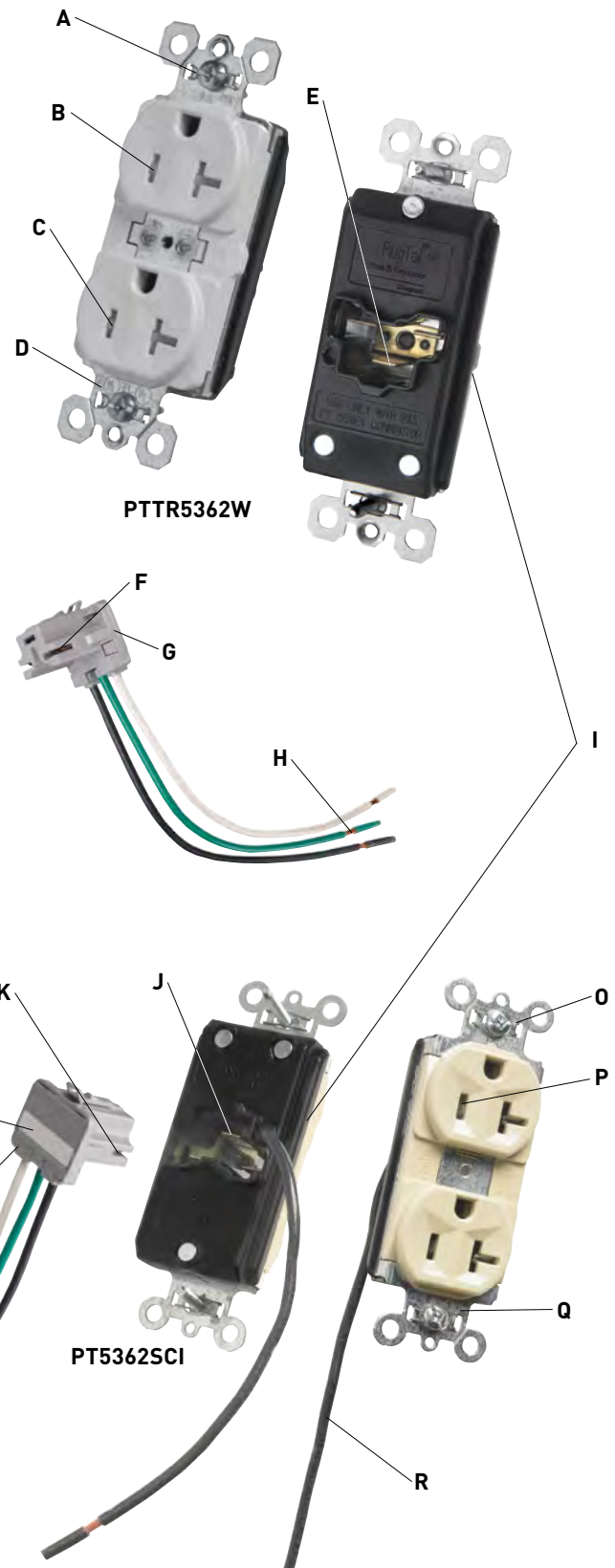

STRAIGHT BLADE RECEPTACLES

PlugTail® Specification Grade Receptacles 15 & 20A, 125V

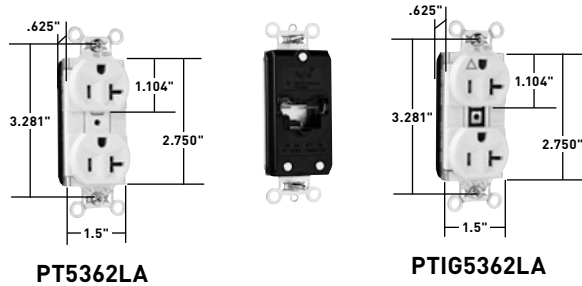

Features

- .036 inch thick, brass, triple-wipe power contacts for lasting retention.
- Plated steel wrap-around strap design for maximum durability and corrosion resistance.
- No exposed terminals create a finger safe application before, during, and after installation.
- Built-in connector features large brass terminal blades to ensure consistent, reliable electrical connections.
- Ultrasonically welded polycarbonate connector housing secures terminations and conductors in a UL Listed, finger-safe housing.
- Crimped and welded contacts.
- Large brass contacts snugly terminate on device blade terminals.
- Pre-stripped connector leads fasten to conductors, easier than standard pigtails.
- Auto-ground clip assures positive ground.
- Isolated ground version features a plastic barrier that isolates grounding terminal from mounting strap and metal boxes.

CATALOG NUMBER	RATING		COLOR	NEMA CONFIG. NO.	3rd PARTY COMPLIANCE	
	A.	V.			cUL ^{us} UL498	FSUL WC596
DUPLEX RECEPTACLES						
PT5262I	15	125	Ivory	5-15R	•	•
PT5262W	15	125	White	5-15R	•	•
PT5262	15	125	Brown	5-15R	•	•
PT5262GRY	15	125	Gray	5-15R	•	•
PT5262BK	15	125	Black	5-15R	•	•
PT5262RED	15	125	Red	5-15R	•	•
PT5262BL	15	125	Blue	5-15R	•	•
PT5362I	20	125	Ivory	5-20R	•	•
PT5362W	20	125	White	5-20R	•	•
PT5362	20	125	Brown	5-20R	•	•
PT5362GRY	20	125	Gray	5-20R	•	•
PT5362BK	20	125	Black	5-20R	•	•
PT5362RED	20	125	Red	5-20R	•	•
PT5362LA	20	125	Light Almond	5-20R	•	•
PT5362BL	20	125	Blue	5-20R	•	•

CATALOG NUMBER		RATING		COLOR	NEMA CONFIG. NO.	3rd PARTY COMPLIANCE	
SPEC GRAD	HOSPITAL GRADE	A.	V.			cUL ^{us} UL498	FSUL WC596
ISOLATED GROUND DUPLEX RECEPTACLES							
PTIG5262W		15	125	White	5-15R	•	•
PTIG5262	PTIG8200	15	125	Orange	5-15R	•	•
PTIG5262RED	PTIG8200RED	15	125	Red	5-15R	•	•
PTIG5262LA		15	125	Light Almond	5-15R	•	•
PTIG5362I	PTIG8300I	20	125	Ivory	5-20R	•	•
PTIG5362W		20	125	White	5-20R	•	•
PTIG5362	PTIG8300	20	125	Orange	5-20R	•	•
PTIG5362GRY		20	125	Gray	5-20R	•	•
PTIG5362RED	PTIG8300RED	20	125	Red	5-20R	•	•
PTIG5362LA		20	125	Light Almond	5-20R	•	•

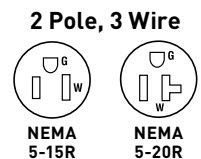

STRAIGHT BLADE RECEPTACLES

For PlugTail Connectors, see Page B-4.
For Bulk Packaging Solutions consult factory.

STRAIGHT BLADE RECEPTACLES

PlugTail® Tamper-Resistant Specification & Hospital Grade Receptacles 15 & 20A, 125V

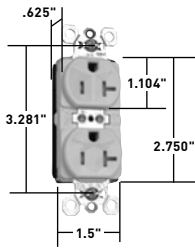

PTTR5362W

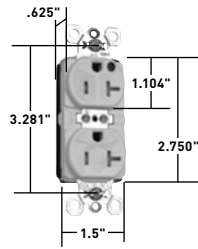

PTTR8300W

Features

- Dual mechanical shutter system to help prevent insertion of foreign objects.
- .036 inch thick, brass, triple-wipe power contacts for lasting retention.
- Plated steel wrap-around strap design for maximum durability and corrosion resistance.
- No exposed terminals create a finger safe application before, during, and after installation.
- Built-in connector features large brass terminal blades to ensure consistent, reliable electrical connections.
- Crimped and welded contacts.
- Ultrasonically welded polycarbonate connector housing secures terminations and conductors in a UL Listed, finger safe housing.
- Large brass contacts snugly terminate on device blade terminals.
- Pre-stripped connector leads fasten to conductors, easier than standard pigtails.
- Auto-ground clip assures positive ground.

CATALOG NUMBER	RATING		COLOR	NEMA CONFIG. NO.	3rd PARTY COMPLIANCE	
	A.	V.			cUL ^{us} UL498	FSUL WC596
DUPLEX RECEPTACLES						
PTTR5262I	15	125	Ivory	5-15R	•	•
PTTR5262W	15	125	White	5-15R	•	•
PTTR5262	15	125	Brown	5-15R	•	•
PTTR5262GRY	15	125	Gray	5-15R	•	•
PTTR5262RED	15	125	Red	5-15R	•	•
PTTR5262LA	15	125	Light Almond	5-15R	•	•
PTTR5362I	20	125	Ivory	5-20R	•	•
PTTR5362W	20	125	White	5-20R	•	•
PTTR5362	20	125	Brown	5-20R	•	•
PTTR5362GRY	20	125	Gray	5-20R	•	•
PTTR5362BK	20	125	Black	5-20R	•	•
PTTR5362LA	20	125	Light Almond	5-20R	•	•

CATALOG NUMBER	RATING		COLOR	NEMA CONFIG. NO.	3rd PARTY COMPLIANCE	
	A.	V.			cUL ^{us} UL498	FSUL WC596
HOSPITAL GRADE DUPLEX RECEPTACLES						
PTTR8200I	15	125	Ivory	5-15R	•	•
PTTR8200W	15	125	White	5-15R	•	•
PTTR8200RED	15	125	Red	5-15R	•	•
PTTR8300I	20	125	Ivory	5-20R	•	•
PTTR8300W	20	125	White	5-20R	•	•
PTTR8300	20	125	Brown	5-20R	•	•
PTTR8300GRY	20	125	Gray	5-20R	•	•
PTTR8300BK	20	125	Black	5-20R	•	•
PTTR8300RED	20	125	Red	5-20R	•	•
PTTR8300LA	20	125	Light Almond	5-20R	•	•

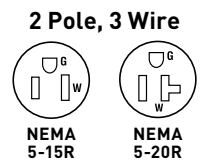

For Bulk Packaging Solutions consult factory.

All devices listed on this page conform to NEMA WD-1 and WD-6.

STRAIGHT BLADE RECEPTACLES

PlugTail® Hospital Grade Receptacles 15 & 20A, 125V

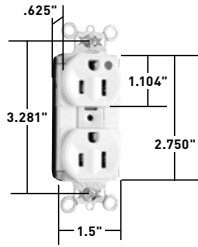

PT8200HW

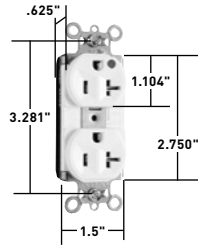

PT8300HW

Features

- .036 inch thick, brass, triple-wipe power contacts for lasting retention.
- Plated steel wrap-around strap design for maximum durability and corrosion resistance.
- No exposed terminals create a fingersafe application before, during, and after installation.
- Built-in connector features large brass terminal blades to ensure consistent, reliable electrical connections.
- Crimped and welded contacts.
- Ultrasonically welded polycarbonate connector housing secures terminations and conductors in a UL Listed, finger-safe housing.
- Large brass contacts snugly terminate on device blade terminals. Audible snapping latch assures connection, allows release.
- Pre-stripped connector leads fasten to conductors, easier than standard pigtails.
- Auto-ground clip assures positive ground.

CATALOG NUMBER	RATING		COLOR	NEMA CONFIG. NO.	3rd PARTY COMPLIANCE		
	A.	V.			cUL ^{us} UL498	FSUL WC596	CSA C22.2 No. 42
HEAVY-DUTY COMPACT DESIGN DUPLEX RECEPTACLES							
PT8200HI	15	125	Ivory	5-15R	•	•	•
PT8200HGRY	15	125	Gray	5-15R	•	•	•
PT8200HRED	15	125	Red	5-15R	•	•	•
PT8200HW	15	125	White	5-15R	•	•	•
PT8200HLA	15	125	Light Almond	5-15R	•	•	•
PT8300HI	20	125	Ivory	5-20R	•	•	•
PT8300HGRY	20	125	Gray	5-20R	•	•	•
PT8300HRED	20	125	Red	5-20R	•	•	•
PT8300HW	20	125	White	5-20R	•	•	•
PT8300HBK	20	125	Black	5-20R	•	•	•
PT8300HLA	20	125	Light Almond	5-20R	•	•	•
PT8300H	20	125	Brown	5-20R	•	•	•

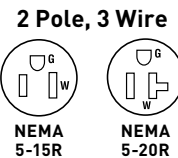

STRAIGHT BLADE RECEPTACLES

For Bulk Packaging Solutions consult factory.

STRAIGHT BLADE RECEPTACLES

PlugTail® Specification Grade Receptacles Split Circuit 15 & 20A, 125V

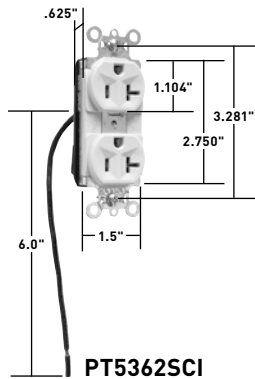

PT5362SCI

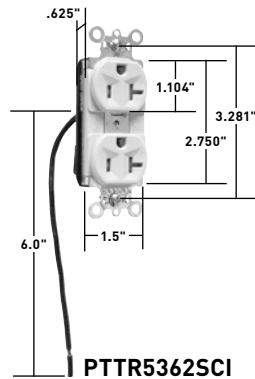

PTTR5362SCI

Features

- Pre-wired with one welded pre-stripped wire lead to facilitate switched receptacle circuit applications.
- .036 inch thick, brass, triple-wipe power contacts for lasting retention.
- Plated steel wrap-around strap design for maximum durability and corrosion resistance.
- No exposed terminals create a finger safe application before, during, and after installation.
- Built-in connector features large brass terminal blades to ensure consistent, reliable electrical connections.
- Crimped and welded contacts.
- Ultrasonically welded polycarbonate connector housing secures terminations and conductors in a UL Listed, finger safe housing.
- Large brass contacts snugly terminate on device blade terminals.
- Pre-stripped connector leads fasten to conductors, easier than standard pigtailed.
- Auto-ground clip assures positive ground.
- Tamper-resistant version features dual mechanical shutter system to help prevent insertion of foreign objects.

CATALOG NUMBER	RATING		COLOR	NEMA CONFIG. NO.	3rd PARTY COMPLIANCE	
	A.	V.			cUL ^{us} UL498	FSUL WC596
SPLIT CIRCUIT DUPLEX RECEPTACLES WITH 6" LEAD						
PT5262SCW	15	125	White	5-15R	•	•
PT5262SC	15	125	Brown	5-15R	•	•
PT5262SCBK	15	125	Black	5-15R	•	•
PT5362SCI	20	125	Ivory	5-20R	•	•
PT5362SCW	20	125	White	5-20R	•	•
PT5362SC	20	125	Brown	5-20R	•	•
PT5362SCGRY	20	125	Gray	5-20R	•	•
PT5362SCLA	20	125	Light Almond	5-20R	•	•

CATALOG NUMBER	RATING		COLOR	NEMA CONFIG. NO.	3rd PARTY COMPLIANCE	
	A.	V.			cUL ^{us} UL498	FSUL WC596
TAMPER-RESISTANT SPLIT CIRCUIT DUPLEX RECEPTACLES WITH 6" LEAD						
PTTR5262SCW	15	125	White	5-15R	•	•
PTTR5362SCI	20	125	Ivory	5-20R	•	•
PTTR5362SCW	20	125	White	5-20R	•	•

2 Pole, 3 Wire

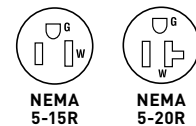

For Bulk Packaging Solutions consult factory.

All devices listed on this page conform to NEMA WD-1 and WD-6.

STRAIGHT BLADE RECEPTACLES

PlugTail® Tamper-Resistant Hospital Grade Decorator Receptacles 15 & 20A, 125V

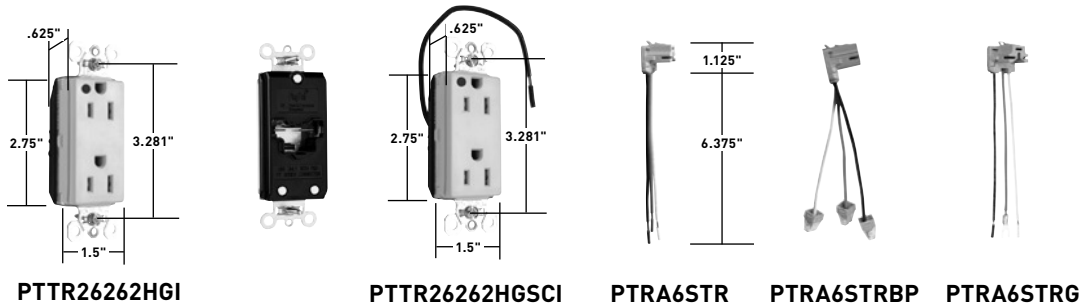

Features

- Dual mechanical shutter system to help prevent insertion of foreign objects.
- .036 inch thick, brass, triple-wipe power contacts for lasting retention.
- Plated steel wrap-around strap design for maximum durability and corrosion resistance.
- No exposed terminals create a finger safe application before, during, and after installation.
- Built-in connector features large brass terminal blades to ensure consistent, reliable electrical connections.
- Crimped and welded contacts.
- Ultrasonically welded polycarbonate connector housing secures terminations and conductors in a UL Listed, finger safe housing.
- Large brass contacts snugly terminate on device blade terminals.
- Pre-stripped connector leads fasten to conductors, easier than standard pigtailed.
- Auto-ground clip assures positive ground.

CATALOG NUMBER	RATING		COLOR	NEMA CONFIG. NO.	3rd PARTY COMPLIANCE	
	A.	V.			UL ^{us} UL498	FSUL WC596
DECORATOR RECEPTACLES WITH 6" LEAD						
PTTR26262HGI	15	125	Ivory	5-15R	•	•
PTTR26262HGW	15	125	White	5-15R	•	•
PTTR26262HGRED	15	125	Red	5-15R	•	•
PTTR26362HGI	20	125	Ivory	5-20R	•	•
PTTR26362HGW	20	125	White	5-20R	•	•
PTTR26362HG	20	125	Brown	5-20R	•	•
PTTR26362HGGRY	20	125	Gray	5-20R	•	•
PTTR26362HGLA	20	125	Light Almond	5-20R	•	•

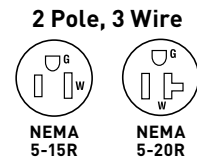

CATALOG NUMBER	WIRE TYPE	WIRE LENGTH
PLUGTAIL CONNECTORS – RIGHT ANGLE		
PTRA6SOL	Solid	6"
PTRA6STR	Stranded	6"
PTRA6SOLB25	Solid	25"
PTRA6STRB25	Stranded	25"
PLUGTAIL CONNECTORS – RIGHT ANGLE WITH WAGO CONNECTORS		
PTRA6SOLBP	Solid	6"
PTRA6STRBP	Stranded	6"
PLUGTAIL CONNECTORS – RIGHT ANGLE W/GROUND SPADE TERMINAL		
PTRA6SOLG	Solid	6"
PTRA6STRG	Stranded	6"

STRAIGHT BLADE RECEPTACLES

STRAIGHT BLADE RECEPTACLES

Plug Load Controllable Decorator Receptacles

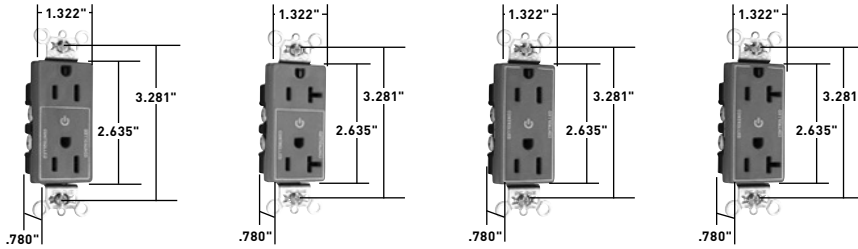

26252CHBK

26352CHBK

26252CDBK

26352CDBK

Features

- Permanent marking on face of receptacle for superior abrasion resistance.
- .032 inch thick, brass, triple-wipe power contacts for lasting retention.
- Controlled receptacle marking is NEMA-approved and compliant with 2014 NEC®.
- Can be used to control loads using WattStopper® DLM and other building control systems.
- Two drive screws anchor strap to back body and face where abrupt removal torque is strongest.
- Corrosion-resistant, plated steel strap locked into face and back body to resist pulling away from face/body assembly.
- Auto-ground eliminates the necessity to terminate grounding conductor in device.
- Easily accessed break-off, line-contact connecting tab for fast, easy split-circuit wiring.
- Tri-drive steel terminal screws. Internal screw-pressure-plate back and side wire capability. Two backwire holes for more wiring flexibility.
- **CH Version Only:** Split circuit tab broken at the factory, allowing half of the receptacle to be controlled.

CATALOG NUMBER	RATING		COLOR	NEMA CONFIG. NO.	3rd PARTY COMPLIANCE		
	A.	V.			UL498	FSUL WC596	C22.2 No. 42
HALF-CONTROLLED DUPLEX RECEPTACLES BACK & SIDE WIRE							
26252CHI	15	125	Ivory	5-15R	•	•	•
26252CHW	15	125	White	5-15R	•	•	•
26252CH	15	125	Brown	5-15R	•	•	•
26252CHGRY	15	125	Gray	5-15R	•	•	•
26252CHBK	15	125	Black	5-15R	•	•	•
26252CHRED	15	125	Red	5-15R	•	•	•
26252CHLA	15	125	Light Almond	5-15R	•	•	•
26252CHGN	15	125	Green	5-15R	•	•	•
26352CHI	20	125	Ivory	5-20R	•	•	•
26352CHW	20	125	White	5-20R	•	•	•
26352CH	20	125	Brown	5-20R	•	•	•
26352CHGRY	20	125	Gray	5-20R	•	•	•
26352CHBK	20	125	Black	5-20R	•	•	•
26352CHLA	20	125	Light Almond	5-20R	•	•	•
26352CHBL	20	125	Blue	5-20R	•	•	•
26352CHGN	20	125	Green	5-20R	•	•	•
DUAL-CONTROLLED DUPLEX RECEPTACLES BACK & SIDE WIRE							
26252CDI	15	125	Ivory	5-15R	•	•	•
26252CDW	15	125	White	5-15R	•	•	•
26252CD	15	125	Brown	5-15R	•	•	•
26252CDGRY	15	125	Gray	5-15R	•	•	•
26252CDBK	15	125	Black	5-15R	•	•	•
26252CDLA	15	125	Light Almond	5-15R	•	•	•
26252CDBL	15	125	Blue	5-15R	•	•	•
26252CDGN	15	125	Green	5-15R	•	•	•
26352CDI	20	125	Ivory	5-20R	•	•	•
26352CDW	20	125	White	5-20R	•	•	•
26352CD	20	125	Brown	5-20R	•	•	•
26352CDGRY	20	125	Gray	5-20R	•	•	•
26352CDBK	20	125	Black	5-20R	•	•	•
26352CDLA	20	125	Light Almond	5-20R	•	•	•
26352CDBL	20	125	Blue	5-20R	•	•	•
26352CDGN	20	125	Green	5-20R	•	•	•

2 Pole, 3 Wire

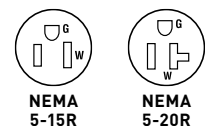

For Bulk Packaging Solutions consult factory.

All devices listed on this page conform to NEMA WD-1 and WD-6.

STRAIGHT BLADE RECEPTACLES

Plug Load Controllable Receptacles

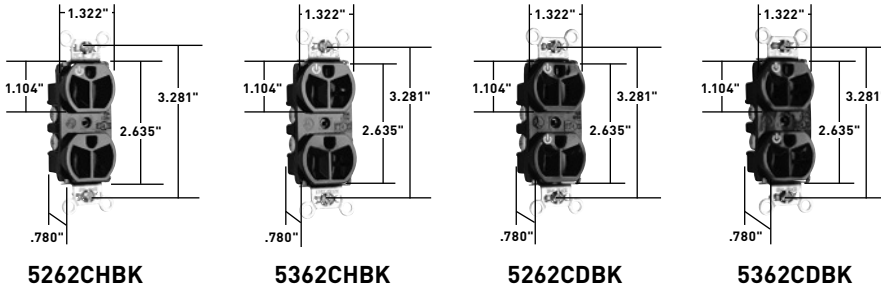

Features

- Pad-printed ink on face of receptacle for superior abrasion resistance.
- .032 inch thick, brass, triple-wipe power contacts for lasting retention.
- Controlled receptacle marking is NEMA-approved and compliant with 2014 NEC®.
- Can be used to control loads using WattStopper® DLM and other building control systems.
- Two drive screws anchor strap to back body and face where abrupt removal torque is strongest.
- Corrosion-resistant, plated steel strap locked into face and back body to resist pulling away from face/body assembly.
- Auto-ground eliminates the necessity to terminate grounding conductor in device.
- Easily accessed break-off, line-contact connecting tab for fast, easy split-circuit wiring.
- Tri-drive steel terminal screws. Internal screw-pressure-plate back and side wire capability. Two backwire holes for more wiring flexibility.
- **CH Version Only:** Split circuit tab broken at the factory, allowing half of the receptacle to be controlled.

CATALOG NUMBER	RATING		COLOR	NEMA CONFIG. NO.	3rd PARTY COMPLIANCE		
	A.	V.			UL498	FSUL WC596	CSA C22.2 No. 42
HALF-CONTROLLED DUPLEX RECEPTACLES BACK & SIDE WIRE							
5262CHI	15	125	Ivory	5-15R	•	•	•
5262CHW	15	125	White	5-15R	•	•	•
5262CH	15	125	Brown	5-15R	•	•	•
5262CHGRY	15	125	Gray	5-15R	•	•	•
5262CHBK	15	125	Black	5-15R	•	•	•
5262CHLA	15	125	Light Almond	5-15R	•	•	•
5262CHBL	15	125	Blue	5-15R	•	•	•
5262CHGN	15	125	Green	5-15R	•	•	•
5362CHI	20	125	Ivory	5-20R	•	•	•
5362CHW	20	125	White	5-20R	•	•	•
5362CH	20	125	Brown	5-20R	•	•	•
5362CHGRY	20	125	Gray	5-20R	•	•	•
5362CHBK	20	125	Black	5-20R	•	•	•
5362CHLA	20	125	Light Almond	5-20R	•	•	•
5362CHBL	20	125	Blue	5-20R	•	•	•
5362CHGN	20	125	Green	5-20R	•	•	•
DUAL-CONTROLLED DUPLEX RECEPTACLES BACK & SIDE WIRE							
5262CDI	15	125	Ivory	5-15R	•	•	•
5262CDW	15	125	White	5-15R	•	•	•
5262CD	15	125	Brown	5-15R	•	•	•
5262CDGRY	15	125	Gray	5-15R	•	•	•
5262CDBK	15	125	Black	5-15R	•	•	•
5262CDLA	15	125	Light Almond	5-15R	•	•	•
5262CDBL	15	125	Blue	5-15R	•	•	•
5262CDGN	15	125	Green	5-15R	•	•	•
5362CDI	20	125	Ivory	5-20R	•	•	•
5362CDW	20	125	White	5-20R	•	•	•
5362CD	20	125	Brown	5-20R	•	•	•
5362CDGRY	20	125	Gray	5-20R	•	•	•
5362CDBK	20	125	Black	5-20R	•	•	•
5362CDLA	20	125	Light Almond	5-20R	•	•	•
5362CDBL	20	125	Blue	5-20R	•	•	•
5362CDGN	20	125	Green	5-20R	•	•	•

2 Pole, 3 Wire

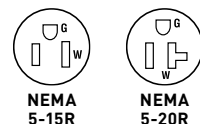

For Bulk Packaging Solutions consult factory.

STRAIGHT BLADE RECEPTACLES

STRAIGHT BLADE RECEPTACLES

Hard Use Specification Grade Receptacles 15A & 20A, 125 & 125/250V

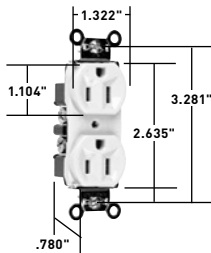

5262I

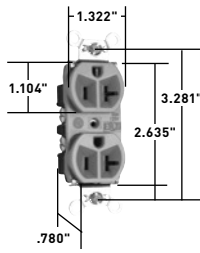

5362GN

Features

- Corrosion-resistant, plated and tabbed steel strap is locked in to face and back body to resist pulling away from face/body assembly.
- .032 inch thick, brass, triple-wipe power contacts for lasting retention.
- Easily accessed break-off, line-contact connecting tab for fast, easy split-circuit wiring.
- Impact-resistant nylon face.
- 8 hole internal screw-pressure-plate back wire terminals accept #10 – 14 AWG solid or stranded copper or copper-clad conductors.
- Terminal compartments isolated from each other for positive conductor containment.
- Tri-drive terminal and mounting screws.
- Auto-ground clip assures positive ground.

CATALOG NUMBER	RATING		COLOR	NEMA CONFIG. NO.	3rd PARTY COMPLIANCE		
	A.	V.			UL498	FSUL WC596	C22.2 No. 42
DUPLIX RECEPTACLES BACK & SIDE WIRE							
5262I	15	125	Ivory	5-15R	•	•	•
5262W	15	125	White	5-15R	•	•	•
5262	15	125	Brown	5-15R	•	•	•
5262GRY	15	125	Gray	5-15R	•	•	•
5262BK	15	125	Black	5-15R	•	•	•
5262RED	15	125	Red	5-15Ra	•	•	•
5262LA	15	125	Light Almond	5-15R	•	•	•
5362I	20	125	Ivory	5-20R	•	•	•
5362W	20	125	White	5-20R	•	•	•
5362	20	125	Brown	5-20R	•	•	•
5362GRY	20	125	Gray	5-20R	•	•	•
5362BK	20	125	Black	5-20R	•	•	•
5362RED	20	125	Red	5-20R	•	•	•
5362LA	20	125	Light Almond	5-20R	•	•	•
5362BL	20	125	Blue	5-20R	•	•	•
5362GN	20	125	Green	5-20R	•	•	•
5362OR	20	125	Orange	5-20R	•	•	•
COMBINATION DUPLIX RECEPTACLES SIDE WIRE							
5290I	15	125/250	Ivory	5/6-15R	•	•	•
5290	15	125/250	Brown	5/6-15R	•	•	•
5890I	20	125/250	Ivory	5/6-20R	•	•	•
5890W	20	125/250	White	5/6-20R	•	•	•
5890	20	125/250	Brown	5/6-20R	•	•	•

2 Pole, 3 Wire

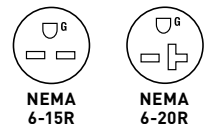
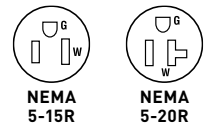

STRAIGHT BLADE RECEPTACLES

For Bulk Packaging Solutions consult factory.

All devices listed on this page conform to NEMA WD-1 and WD-6.

STRAIGHT BLADE RECEPTACLES

Construction Specification Grade Receptacles 15 & 20A, 125V

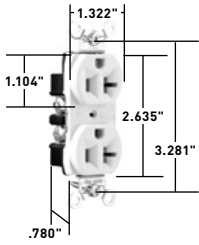

CRB5362I

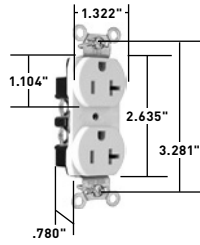

CRB5362SW

Features

- Corrosion-resistant, plated steel strap locked in to face and back body to resist pulling away from face/body assembly.
- .032 inch thick, brass, triple-wipe power contacts for lasting retention.
- Easily accessed break-off, line-contact connecting tab for fast, easy split-circuit wiring.
- Impact-resistant nylon face and thermoplastic back body.
- 8 hole internal screw-pressure-plate back wire terminals accept #10 – 14 AWG solid or stranded copper or copper-clad conductors.
- Terminal compartments isolated from each other for positive conductor containment.
- Tri-drive terminal and mounting screws.
- Auto-ground clip assures positive ground.

CATALOG NUMBER	RATING		COLOR	NEMA CONFIG. NO.	3rd PARTY COMPLIANCE		
	A.	V.			UL [®] UL498	FSUL WC596	CSA C22.2 No. 42
DUPLEX RECEPTACLES BACK & SIDE WIRE							
CRB5262I	15	125	Ivory	5-15R	•	•	•
CRB5262W	15	125	White	5-15R	•	•	•
CRB5262	15	125	Brown	5-15R	•	•	•
CRB5262GRY	15	125	Gray	5-15R	•	•	•
CRB5262BK	15	125	Black	5-15R	•	•	•
CRB5262RED	15	125	Red	5-15R	•	•	•
CRB5262LA	15	125	Light Almond	5-15R	•	•	•
CRB5362I	20	125	Ivory	5-20R	•	•	•
CRB5362W	20	125	White	5-20R	•	•	•
CRB5362	20	125	Brown	5-20R	•	•	•
CRB5362GRY	20	125	Gray	5-20R	•	•	•
CRB5362BK	20	125	Black	5-20R	•	•	•
CRB5362RED	20	125	Red	5-20R	•	•	•
CRB5362LA	20	125	Light Almond	5-20R	•	•	•
SMOOTH FACE DUPLEX RECEPTACLES BACK & SIDE WIRE							
CRB5262SI	15	125	Ivory	5-15R	•	•	•
CRB5262SW	15	125	White	5-15R	•	•	•
CRB5262SGRY	15	125	Gray	5-15R	•	•	•
CRB5262SRED	15	125	Red	5-15R	•	•	•
CRB5262SLA	15	125	Light Almond	5-15R	•	•	•
CRB5362SI	20	125	Ivory	5-20R	•	•	•
CRB5362SW	20	125	White	5-20R	•	•	•
CRB5362S	20	125	Brown	5-20R	•	•	•
CRB5362SGRY	20	125	Gray	5-20R	•	•	•
CRB5362SRED	20	125	Red	5-20R	•	•	•
CRB5362SLA	20	125	Light Almond	5-20R	•	•	•

2 Pole, 3 Wire

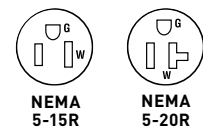

STRAIGHT BLADE RECEPTACLES

For Bulk Packaging Solutions consult factory.

STRAIGHT BLADE RECEPTACLES

Commercial Specification Grade Receptacles 15A, 125V; 20A, 125 & 250V

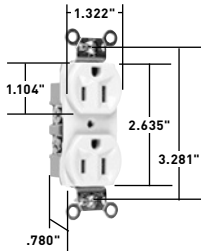

CR15I

Features

- Corrosion-resistant, plated steel strap locked in to face and back body to resist pulling away from face/body assembly.
- .032 inch thick, brass, triple-wipe power contacts for lasting retention.
- Easily accessed break-off, line-contact connecting tab for fast, easy split-circuit wiring.
- Impact-resistant nylon face and thermoplastic back body.
- Accepts #14 – #10 AWG solid or stranded copper or copper-clad wire.
- Terminal compartments isolated from each other for positive conductor containment.
- Tri-drive terminal and mounting screws.
- Auto-ground clip assures positive ground.

CATALOG NUMBER	RATING		COLOR	NEMA CONFIG. NO.	3rd PARTY COMPLIANCE	
	A.	V.			UL498	C22.2 No. 42
DUPLIX RECEPTACLES SIDE WIRE						
CR15I	15	125	Ivory	5-15R	•	•
CR15W	15	125	White	5-15R	•	•
CR15	15	125	Brown	5-15R	•	•
CR15GRY	15	125	Gray	5-15R	•	•
CR15LA	15	125	Light Almond	5-15R	•	•
DUPLIX RECEPTACLES SIDE WIRE						
CR20I	20	125	Ivory	5-20R	•	•
CR20W	20	125	White	5-20R	•	•
CR20	20	125	Brown	5-20R	•	•
CR20GRY	20	125	Gray	5-20R	•	•
CR20BK	20	125	Black	5-20R	•	•
CR20RED	20	125	Red	5-20R	•	•
CR20LA	20	125	Light Almond	5-20R	•	•
DUPLIX RECEPTACLES SIDE WIRE						
5850I	20	250	Ivory	6-20R	•	•
5850W	20	250	White	6-20R	•	•

2 Pole, 3 Wire

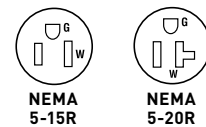

For Bulk Packaging Solutions consult factory.

All devices listed on this page conform to NEMA WD-1 and WD-6.

STRAIGHT BLADE RECEPTACLES

Hospital Grade Single Receptacles 15 & 20A, 125V; 20A, 250V

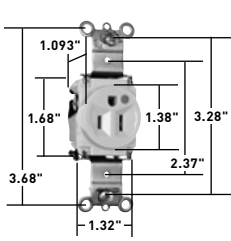

82011

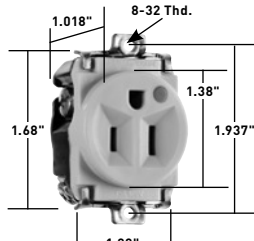

82841

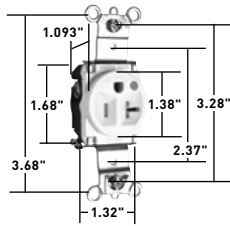

TR8301LA

CATALOG NUMBER	RATING		COLOR	NEMA CONFIG. NO.	3rd PARTY COMPLIANCE		
	A.	V.			UL498	FSUL WC596	cUL/CSA
SINGLE RECEPTACLES BACK & SIDE WIRE							
82011	15	125	Ivory	5-15R	•	•	•
8201W	15	125	White	5-15R	•	•	•
8201	15	125	Brown	5-15R	•	•	•
8201GRY	15	125	Gray	5-15R	•	•	•
8201BK	15	125	Black	5-15R	•	•	•
8201RED	15	125	Red	5-15R	•	•	•
8201LA	15	125	Light Almond	5-15R	•	•	•
83011	20	125	Ivory	5-20R	•	•	•
8301W	20	125	White	5-20R	•	•	•
8301	20	125	Brown	5-20R	•	•	•
8301GRY	20	125	Gray	5-20R	•	•	•
8301RED	20	125	Red	5-20R	•	•	•
8301LA	20	125	Light Almond	5-20R	•	•	•
88011	20	250	Ivory	6-20R	•	•	•
8801W	20	250	White	6-20R	•	•	•
8801	20	250	Brown	6-20R	•	•	•
8801GRY	20	250	Gray	6-20R	•	•	•
8801RED	20	250	Red	6-20R	•	•	•
8801LA	20	250	Light Almond	6-20R	•	•	•
TAMPER-RESISTANT SINGLE RECEPTACLES, BACK & SIDE WIRE							
TR82011	15	125	Ivory	5-15R	•	•	•
TR8201W	15	125	White	5-15R	•	•	•
TR8201	15	125	Brown	5-15R	•	•	•
TR8201GRY	15	125	Gray	5-15R	•	•	•
TR8201BK	15	125	Black	5-15R	•	•	•
TR8201RED	15	125	Red	5-15R	•	•	•
TR8201LA	15	125	Light Almond	5-15R	•	•	•
TR83011	20	125	Ivory	5-20R	•	•	•
TR8301W	20	125	White	5-20R	•	•	•
TR8301	20	125	Brown	5-20R	•	•	•
TR8301BK	20	125	Black	5-20R	•	•	•
TR8301RED	20	125	Red	5-20R	•	•	•
TR8301LA	20	125	Light Almond	5-20R	•	•	•
SHORT STRAP SINGLE RECEPTACLES 1.937" SCREW SPACING, BACK & SIDE WIRE							
82841	15	125	Ivory	5-15R	•	•	•
8284	15	125	Brown	5-15R	•	•	•
83841	20	125	Ivory	5-20R	•	•	•
8384	20	125	Brown	5-20R	•	•	•

2 Pole, 3 Wire

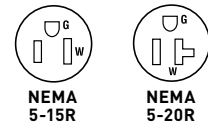

STRAIGHT BLADE RECEPTACLES

For Hospital Use Power Interrupting Device consult Turnlok® Section H.

For Bulk Packaging Solutions consult factory.

STRAIGHT BLADE RECEPTACLES

Heavy-Duty Specification Grade Single Receptacles 15 & 20A, 125 & 250V

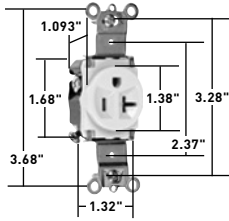

5361I

Features

- Corrosion-resistant, plated steel strap locked in to face and back body to resist pulling away from face/body assembly.
- One-piece brass, triple-wipe power contacts for lasting retention.
- Easily accessed break-off, line-contact connecting tab for fast, easy split-circuit wiring.
- Impact-resistant nylon face and thermoplastic back body.
- Internal screw-pressure-plate back wire capable of accepting #14 – #10 AWG solid or stranded copper or copper-clad wire.
- Terminal compartments isolated from each other for positive conductor containment.
- Tri-drive terminal and mounting screws.
- Auto-ground clip assures positive ground.

CATALOG NUMBER	RATING		COLOR	NEMA CONFIG. NO.	3rd PARTY COMPLIANCE		
	A.	V.			UL498	FSUL WC596	C22.2 No. 42
SINGLE RECEPTACLES BACK & SIDE WIRE							
5261I	15	125	Ivory	5-15R	•	•	•
5261W	15	125	White	5-15R	•	•	•
5261	15	125	Brown	5-15R	•	•	•
5261GRY	15	125	Gray	5-15R	•	•	•
5261BK	15	125	Black	5-15R	•	•	•
5261RED	15	125	Red	5-15R	•	•	•
5261LA	15	125	Light Almond	5-15R	•	•	•
5361I	20	125	Ivory	5-20R	•	•	•
5361W	20	125	White	5-20R	•	•	•
5361	20	125	Brown	5-20R	•	•	•
5361GRY	20	125	Gray	5-20R	•	•	•
5361BK	20	125	Black	5-20R	•	•	•
5361RED	20	125	Red	5-20R	•	•	•
5361LA	20	125	Light Almond	5-20R	•	•	•
5671I	15	250	Ivory	6-15R	•	•	•
5671	15	250	Brown	6-15R	•	•	•
5671RED	15	250	Red	6-15R	•	•	•
5671LA	15	250	Light Almond	6-15R	•	•	•
5871I	20	250	Ivory	6-20R	•	•	•
5871W	20	250	White	6-20R	•	•	•
5871	20	250	Brown	6-20R	•	•	•
5871GRY	20	250	Gray	6-20R	•	•	•
5871BK	20	250	Black	6-20R	•	•	•
5871RED	20	250	Red	6-20R	•	•	•
5871LA	20	250	Light Almond	6-20R	•	•	•

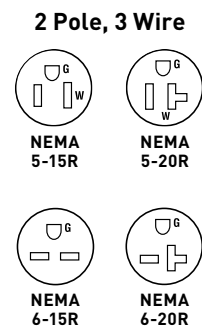

For Bulk Packaging Solutions consult factory.

All devices listed on this page conform to NEMA WD-1 and WD-6.

STRAIGHT BLADE RECEPTACLES

Specification Grade Single Receptacles 15 & 20A, 125 & 250V

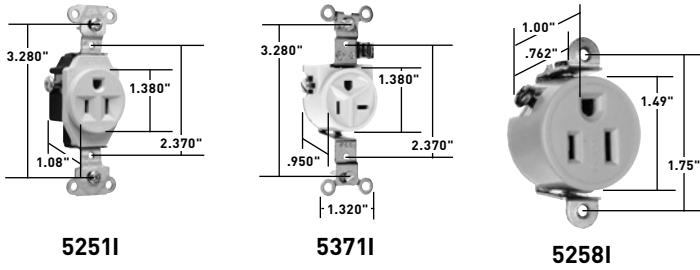

Features

- Auto-ground clip assures positive ground.
- Two drive screws anchor strap to back body and face where abrupt removal torque is greatest.
- Heavy-duty, corrosion-resistant zinc-plated steel strap for added strength.
- One-piece brass triple-wipe power contacts for lasting retention.

CATALOG NUMBER	RATING		COLOR	NEMA CONFIG. NO.	3rd PARTY COMPLIANCE	
	A.	V.			UL498	C22.2 No. 42
SINGLE RECEPTACLES SIDE WIRE						
5251I	15	125	Ivory	5-15R	•	•
5251W	15	125	White	5-15R	•	•
5251	15	125	Brown	5-15R	•	•
5251LA	15	125	Light Almond	5-15R	•	•
5351I	20	125	Ivory	5-20R	•	•
5351W	20	125	White	5-20R	•	•
5351	20	125	Brown	5-20R	•	•
5351LA	20	125	Light Almond	5-20R	•	•
5651I	15	250	Ivory	6-15R	•	•
5651W	15	250	White	6-15R	•	•
5651	15	250	Brown	6-15R	•	•
5651LA	15	250	Light Almond	6-15R	•	•
5851I	20	250	Ivory	6-20R	•	•
5851W	20	250	White	6-20R	•	•
5851	20	250	Brown	6-20R	•	•
5851LA	20	250	Light Almond	6-20R	•	•
SHORT STRAP SINGLE RECEPTACLES SCREW SPACING 2.370"						
5251SSWB	15	125	White	5-15R	•	•
5251SSLAB	15	125	Light Almond	5-15R	•	•
SINGLE RECEPTACLES SIDE WIRE RIGHT ANGLE SLOTS						
5371I	20	125	Ivory	Non-NEMA	•	•
5371W	20	125	White	Non-NEMA	•	•
5371	20	125	Brown	Non-NEMA	•	•
SHORT STRAP SINGLE RECEPTACLES SCREW SPACING 1.750"						
5258I	15	125	Ivory	5-15R	•	•
5258W	15	125	White	5-15R	•	•
5258	15	125	Brown	5-15R	•	•
5258BK	15	125	Black	5-15R	•	•
5358I	20	125	Ivory	5-20R	•	•
5358W	20	125	White	5-20R	•	•
5358	20	125	Brown	5-20R	•	•
5358BK	20	125	Black	5-20R	•	•
5658I	15	250	Ivory	6-15R	•	•
5658	15	250	Brown	6-15R	•	•
5858I	20	250	Ivory	6-20R	•	•
5858W	20	250	White	6-20R	•	•
5858	20	250	Brown	6-20R	•	•

Supplied with mounting screws.

For Bulk Packaging Solutions consult factory.

2 Pole, 3 Wire

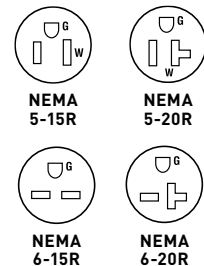

STRAIGHT BLADE RECEPTACLES

Tamper-Resistant Industrial Grade Receptacles 15 & 20A, 125V

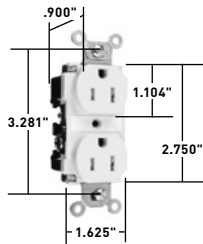

TR621

Features

- Thermoplastic dual mechanism shutter system to help prevent insertion of foreign objects.
- Exclusive patented feature, circuit label on face allows permanent circuit identification.
- Extra heavy-duty brass, one-piece mounting strap with integral ground.
- One-piece, brass, triple-wipe power contacts for lasting retention.
- Strap tabs wrap around and lock down on face to prevent strap from separating from face and back body.
- Impact-resistant nylon face and back body.
- Easily accessed break-off, line-contact connecting tab for fast, easy split-circuit wiring.
- Two drive screws anchor strap to back body and face.
- Exclusive patented feature, external screw-pressure-plate back wire clamp on ground terminal for faster, easier installation.
- External screw-pressure-plate back wire clamps with #10 brass terminal screws for visual assurance of a good connection.
- Auto-ground clip assures positive ground.

CATALOG NUMBER	RATING		COLOR	NEMA CONFIG. NO.	3rd PARTY COMPLIANCE		
	A.	V.			UL498	FSUL WC596	C22.2 No. 42
DUPLIX RECEPTACLES BACK & SIDE WIRE							
TR621	15	125	Ivory	5-15R	•	•	•
TR62W	15	125	White	5-15R	•	•	•
TR62	15	125	Brown	5-15R	•	•	•
TR62GRY	15	125	Gray	5-15R	•	•	•
TR62LA	15	125	Light Almond	5-15R	•	•	•
TR631	20	125	Ivory	5-20R	•	•	•
TR63W	20	125	White	5-20R	•	•	•
TR63	20	125	Brown	5-20R	•	•	•
TR63GRY	20	125	Gray	5-20R	•	•	•
TR63BK	20	125	Black	5-20R	•	•	•
TR63RED	20	125	Red	5-20R	•	•	•
TR63LA	20	125	Light Almond	5-20R	•	•	•
TR63BL	20	125	Blue	5-20R	•	•	•

2 Pole, 3 Wire

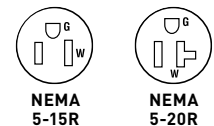

For PlugTail® Tamper-Resistant Receptacles, see Page B-17.

For Bulk Packaging Solutions consult factory.

All devices listed on this page conform to NEMA WD-1 and WD-6.

STRAIGHT BLADE RECEPTACLES

Tamper-Resistant Hospital Grade & Power Indicating Receptacles 15 & 20A, 125V

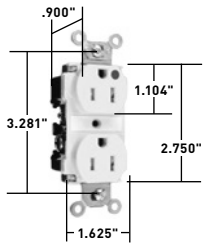

TR62HI

Features

- Thermoplastic dual mechanism shutter system to help prevent insertion of foreign objects.
- Exclusive patented feature, circuit label on face allows permanent circuit identification.
- Extra heavy-duty brass, one-piece mounting strap with integral ground.
- One-piece, nickel-plated brass, triple-wipe power contacts for lasting retention.
- Strap tabs wrap around and lock down on face to prevent strap from separating from face and back body.
- Impact-resistant nylon face and back body.
- Easily accessed break-off, line-contact connecting tab for fast, easy split-circuit wiring.
- Two drive screws anchor strap to back body and face.
- Exclusive patented feature, external screw-pressure-plate back wire clamp on ground terminal for faster, easier installation.
- External screw-pressure-plate back wire clamps with #10 brass terminal screws for visual assurance of a good connection.
- Auto-ground clip assures positive ground.

CATALOG NUMBER	RATING		COLOR	NEMA CONFIG. NO.	3rd PARTY COMPLIANCE		
	A.	V.			UL498	FSUL WC596	C22.2 No. 42
HOSPITAL GRADE DUPLEX RECEPTACLES BACK & SIDE WIRE							
TR62HI	15	125	Ivory	5-15R	•	•	•
TR62HW	15	125	White	5-15R	•	•	•
TR62H	15	125	Brown	5-15R	•	•	•
TR62HGRY	15	125	Gray	5-15R	•	•	•
TR62HRED	15	125	Red	5-15R	•	•	•
TR62HLA	15	125	Light Almond	5-15R	•	•	•
TR63HI	20	125	Ivory	5-20R	•	•	•
TR63HW	20	125	White	5-20R	•	•	•
TR63H	20	125	Brown	5-20R	•	•	•
TR63HGRY	20	125	Gray	5-20R	•	•	•
TR63HRED	20	125	Red	5-20R	•	•	•
TR63HLA	20	125	Light Almond	5-20R	•	•	•
TR63HBL	20	125	Blue	5-20R	•	•	•
POWER INDICATOR HEAVY-DUTY HOSPITAL GRADE DUPLEX RECEPTACLES BACK & SIDE WIRE							
TR8200PI	15	125	Brown	5-15R	•	•	•
TR8200PIW	15	125	White	5-15R	•	•	•
TR8200PILA	15	125	Light Almond	5-15R	•	•	•
TR8200PII	15	125	Ivory	5-15R	•	•	•
TR8200PIRED	15	125	Red	5-15R	•	•	•
TR8200PIGRY	15	125	Gray	5-15R	•	•	•
TR8300PI	20	125	Brown	5-20R	•	•	•
TR8300PIW	20	125	White	5-20R	•	•	•
TR8300PILA	20	125	Light Almond	5-20R	•	•	•
TR8300PII	20	125	Ivory	5-20R	•	•	•
TR8300PIRED	20	125	Red	5-20R	•	•	•
TR8300PIGRY	20	125	Gray	5-20R	•	•	•
POWER INDICATOR EXTRA HEAVY-DUTY HOSPITAL GRADE DUPLEX RECEPTACLES BACK & SIDE WIRE							
TR8200HPI	15	125	Brown	5-15R	•	•	•
TR8200HPIW	15	125	White	5-15R	•	•	•
TR8200HPILA	15	125	Light Almond	5-15R	•	•	•
TR8200HPPII	15	125	Ivory	5-15R	•	•	•
TR8200HPPIRED	15	125	Red	5-15R	•	•	•
TR8200HPPIGRY	15	125	Gray	5-15R	•	•	•
TR8300HPI	20	125	Brown	5-20R	•	•	•
TR8300HPIW	20	125	White	5-20R	•	•	•
TR8300HPILA	20	125	Light Almond	5-20R	•	•	•
TR8300HPPII	20	125	Ivory	5-20R	•	•	•
TR8300HPPIRED	20	125	Red	5-20R	•	•	•
TR8300HPPIGRY	20	125	Gray	5-20R	•	•	•

2 Pole, 3 Wire

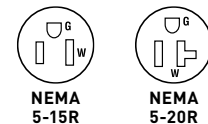

For PlugTail® Tamper-Resistant Receptacles, see Page B-20.

STRAIGHT BLADE RECEPTACLES

For Bulk Packaging Solutions consult factory.

STRAIGHT BLADE RECEPTACLES

Tamper-Resistant Hard Use Receptacles 15 & 20A, 125V

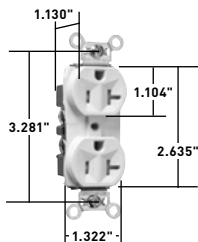

TR5362LA

Features

- Dual mechanical shutter system to help prevent insertion of foreign objects.
- Auto-ground clip assures positive ground.
- Easily accessed break-off line-contact connecting tab for fast and easy split-circuit wiring.
- Backed-out tri-drive brass terminal screws for faster installation. Internal screw-pressure-plate back and side wire capability. Two back wire holes for additional wiring flexibility.
- Corrosion-resistant plated steel strap is locked in to face and back body to resist pulling away from the face/body assembly.
- .032 inch thick brass triple-wipe power contacts.
- Two drive screws anchor steel strap to back body and face where abrupt removal torque is greatest.

CATALOG NUMBER	RATING		COLOR	NEMA CONFIG. NO.	3rd PARTY COMPLIANCE		
	A.	V.			UL498	FSUL WC596	C22.2 No. 42
TAMPER-RESISTANT HARD USE DUPLEX RECEPTACLES BACK & SIDE WIRE							
TR5262I	15	125	Ivory	5-15R	•	•	•
TR5262W	15	125	White	5-15R	•	•	•
TR5262	15	125	Brown	5-15R	•	•	•
TR5262GRY	15	125	Gray	5-15R	•	•	•
TR5262BK	15	125	Black	5-15R	•	•	•
TR5262RED	15	125	Red	5-15R	•	•	•
TR5262LA	15	125	Light Almond	5-15R	•	•	•
TR5362I	20	125	Ivory	5-20R	•	•	•
TR5362W	20	125	White	5-20R	•	•	•
TR5362	20	125	Brown	5-20R	•	•	•
TR5362GRY	20	125	Gray	5-20R	•	•	•
TR5362BK	20	125	Black	5-20R	•	•	•
TR5362RED	20	125	Red	5-20R	•	•	•
TR5362LA	20	125	Light Almond	5-20R	•	•	•

2 Pole, 3 Wire

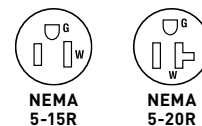

For Bulk Packaging Solutions consult factory.

All devices listed on this page conform to NEMA WD-1 and WD-6.

STRAIGHT BLADE RECEPTACLES

Tamper-Resistant Commercial Grade Receptacles 15 & 20A, 125V

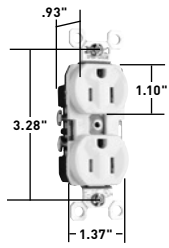

TR15LA

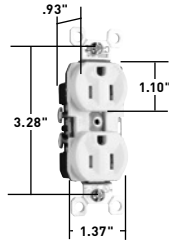

TR5252W

Features

- Dual mechanical shutter system to help prevent insertions of foreign objects.
- Two drive screws anchor strap to back body and face where abrupt removal torque is greatest.
- .032 inch thick brass triple-wipe power contacts for lasting retention.
- Corrosion-resistant plated steel strap is locked in to the face and back body to resist pulling away from the face/body assembly.
- Auto-ground clip assures positive ground.
- Easily accessed break-off line-contact connecting tab for fast and easy split-circuit wiring.
- Backed-out tri-drive steel terminal screws.

CATALOG NUMBER	RATING		COLOR	NEMA CONFIG. NO.	3rd PARTY COMPLIANCE		
	A.	V.			UL498	cULus	C22.2 No. 42
TAMPER-RESISTANT DUPLEX RECEPTACLES SIDE WIRE							
TR15I	15	125	Ivory	5-15R	•	•	•
TR15W	15	125	White	5-15R	•	•	•
TR15	15	125	Brown	5-15R	•	•	•
TR15GRY	15	125	Gray	5-15R	•	•	•
TR15BK	15	125	Black	5-15R	•	•	•
TR15LA	15	125	Light Almond	5-15R	•	•	•
TR20I	20	125	Ivory	5-20R	•	•	•
TR20W	20	125	White	5-20R	•	•	•
TR20	20	125	Brown	5-20R	•	•	•
TR20GRY	20	125	Gray	5-20R	•	•	•
TR20BK	20	125	Black	5-20R	•	•	•
TR20LA	20	125	Light Almond	5-20R	•	•	•

CATALOG NUMBER	RATING		COLOR	NEMA CONFIG. NO.	3rd PARTY COMPLIANCE		
	A.	V.			UL498	FSUL WC596	C22.2 No. 42
TAMPER-RESISTANT COMMERCIAL DUPLEX RECEPTACLES BACK AND SIDE WIRE							
TR5252I	15	125	Ivory	5-15R	•		•
TR5252W	15	125	White	5-15R	•		•
TR5252	15	125	Brown	5-15R	•		•
TR5252GRY	15	125	Gray	5-15R	•		•
TR5252BK	15	125	Black	5-15R	•		•
TR5252LA	15	125	Light Almond	5-15R	•		•
TR5352I	20	125	Ivory	5-20R	•		•
TR5352W	20	125	White	5-20R	•		•
TR5352	20	125	Brown	5-20R	•		•
TR5352GRY	20	125	Gray	5-20R	•		•
TR5352BK	20	125	Black	5-20R	•		•
TR5352LA	20	125	Light Almond	5-20R	•		•

2 Pole, 3 Wire



NEMA 5-15R



NEMA 5-20R

STRAIGHT BLADE RECEPTACLES

For Bulk Packaging Solutions consult factory.

STRAIGHT BLADE RECEPTACLES

Tamper-Resistant Construction Grade Receptacles & Shim-Lock 15 & 20A, 125V

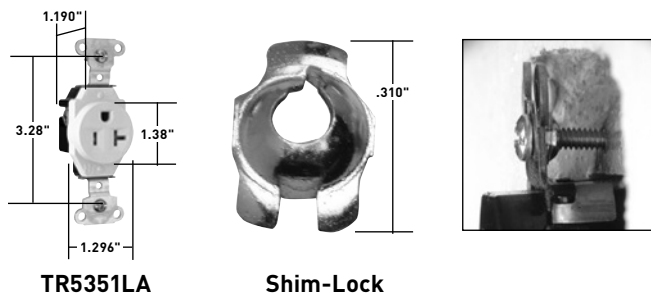

Features

- Dual mechanical shutter system to help prevent insertions of foreign objects.
- Two drive screws anchor strap to back body and face where abrupt removal torque is greatest.
- Heavy-duty, corrosion-resistant zinc-plated steel strap for added strength.
- Backed-out tri-drive steel terminal screws. Internal screw-pressure-plate back and side wire capability. Two back wire holes for increased wiring flexibility.
- One-piece brass triple-wipe power contacts for lasting retention.

CATALOG NUMBER	RATING		COLOR	NEMA CONFIG. NO.	3rd PARTY COMPLIANCE		
	A.	V.			UL498	FSUL WC596	C22.2 No. 42
TAMPER-RESISTANT SINGLE RECEPTACLES BACK & SIDE WIRE							
TR5251I	15	125	Ivory	5-15R	•	•	•
TR5251W	15	125	White	5-15R	•	•	•
TR5251	15	125	Brown	5-15R	•	•	•
TR5251LA	15	125	Light Almond	5-15R	•	•	•
TR5351I	20	125	Ivory	5-20R	•	•	•
TR5351W	20	125	White	5-20R	•	•	•
TR5351	20	125	Brown	5-20R	•	•	•
TR5351LA	20	125	Light Almond	5-20R	•	•	•

2 Pole, 3 Wire

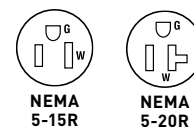

Features

- One Shim-Lock provides a device adjustment depth range between 1/8" and 3/4".
- An inexpensive and quick fix for floating installations.
- Provides a perfect flush mount every time, regardless of the wallboard, tile or panel condition.
- Made of steel and finished with clear zinc chromate plating.

CATALOG NUMBER	DIMENSIONS	QTY. PER PACKAGE
SHIM-LOCK		
SHL20	Length: .310", Screw Opening: #6	20
SHL100	Length: .310", Screw Opening: #6	100

For Bulk Packaging Solutions consult factory.

All devices listed on this page conform to NEMA WD-1 and WD-6.

STRAIGHT BLADE RECEPTACLES

Weather-Resistant Heavy-Duty & Commercial Grade Receptacles 15 & 20A, 125 & 250V

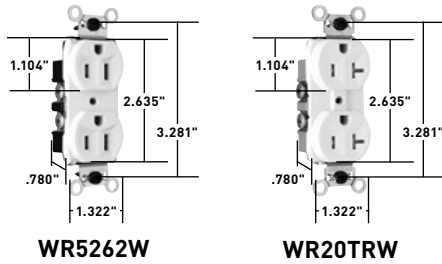

Features

- Auto-ground clip assures positive ground.
- WR marking on face as required by UL Standard.
- Zinc-plated steel mounting screws for greater ease of installation and removal in wet or damp locations.
- Strap tabs wrap around face to prevent strap from separating from face and back body.
- Tri-drive brass terminal screws. Internal screw-pressure-plate back and side wire capability. Two back wire holes for more wiring flexibility.
- Heavy-duty, brass strap for added strength and ground conductivity.
- UV-resistant nylon face for longer life under adverse environmental conditions.
- Two drive screws anchor strap to back body and face where abrupt removal torque is strongest.
- Easily accessed break-off, line-contact connecting tab for fast, easy split-circuit wiring.
- .032 inch thick brass triple-wipe power contacts for lasting retention.

CATALOG NUMBER	RATING		COLOR	NEMA CONFIG. NO.	3rd PARTY COMPLIANCE		
	A.	V.			UL498	FSUL WC596	C22.2 No. 42
WEATHER-RESISTANT DUPLEX RECEPTACLES BACK & SIDE WIRE							
WR5262I	15	125	Ivory	5-15R	•	•	•
WR5262W	15	125	White	5-15R	•	•	•
WR5262GRY	15	125	Gray	5-15R	•	•	•
WR5362I	20	125	Ivory	5-20R	•	•	•
WR5362W	20	125	White	5-20R	•	•	•
WR5362GRY	20	125	Gray	5-20R	•	•	•
WR5662I	15	250	Ivory	6-15R	•	•	•
WR5662GRY	15	250	Gray	6-15R	•	•	•
WR5862I	20	250	Ivory	6-20R	•	•	•
WR5862W	20	250	White	6-20R	•	•	•
WR5862GRY	20	250	Gray	6-20R	•	•	•

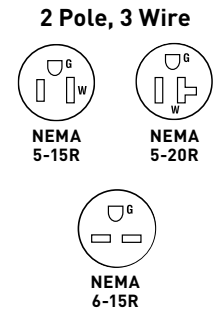

STRAIGHT BLADE RECEPTACLES

CATALOG NUMBER	RATING		COLOR	NEMA CONFIG. NO.	3rd PARTY COMPLIANCE	
	A.	V.			UL498	C22.2 No. 42
WEATHER-RESISTANT TAMPER-RESISTANT DUPLEX RECEPTACLES SIDE WIRE						
WR20TRI	20	125	Ivory	5-20R	•	•
WR20TRW	20	125	White	5-20R	•	•
WR20TR	20	125	Brown	5-20R	•	•
WR20TRGRY	20	125	Gray	5-20R	•	•
WR20TRLA	20	125	Light Almond	5-20R	•	•

WR20TR models are Tamper-Resistant.

National Electrical Code® Section 406.8 Receptacles in Wet or Damp Locations.
Requires that all 15- and 20-amp, 125- and 250-volt non-locking receptacles installed in wet or damp locations shall be weather-resistant receptacles.

For Bulk Packaging Solutions consult factory.

STRAIGHT BLADE RECEPTACLES

Isolated Ground Receptacles 2 Pole, 3 Wire Grounding 15 & 20A, 125V & 250V

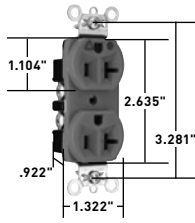

IG8300

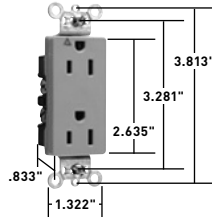

IG2626GRY

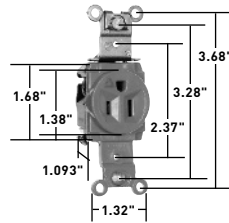

IG5261

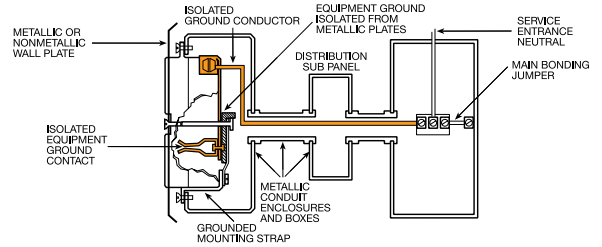

CATALOG NUMBER		RATING		COLOR	NEMA CONFIG. NO.	3rd PARTY COMPLIANCE		
SPEC GRADE	HOSPITAL GRADE	A.	V.			UL498	FSUL WC596	C22.2 No. 42
DUPLEX RECEPTACLES BACK & SIDE WIRE								
IG5262I	IG8200I	15	125	Ivory	5-15R	•	•	•
IG5262W		15	125	White	5-15R	•	•	•
IG5262	IG8200	15	125	Orange	5-15R	•	•	•
IG5262GRY		15	125	Gray	5-15R	•	•	•
IG5262RED	IG8200RED	15	125	Red	5-15R	•	•	•
IG5262LA		15	125	Light Almond	5-15R	•	•	•
IG5362I	IG8300I	20	125	Ivory	5-20R	•	•	•
IG5362W	IG8300W	20	125	White	5-20R	•	•	•
IG5362	IG8300	20	125	Orange	5-20R	•	•	•
IG5362GRY		20	125	Gray	5-20R	•	•	•
IG5362BK		20	125	Black	5-20R	•	•	•
IG5362RED	IG8300RED	20	125	Red	5-20R	•	•	•
IG5362LA	IG8300LA	20	125	Light Almond	5-20R	•	•	•
IG5662		15	250	Orange	6-15R	•	•	•
IG5862	IG8800	20	250	Orange	6-20R	•	•	•
	IG8800LA	20	250	Light Almond	6-20R	•	•	•
DECORATOR DUPLEX RECEPTACLES BACK & SIDE WIRE								
IG2626I		15	125	Ivory	5-15R	•	•	•
IG2626W	IG2626HW	15	125	White	5-15R	•	•	•
IG2626	IG2626HG	15	125	Orange	5-15R	•	•	•
IG2626GRY		15	125	Gray	5-15R	•	•	•
IG2626BK		15	125	Black	5-15R	•	•	•
	IG2626HGRED	15	125	Red	5-15R	•	•	•
IG2636I		20	125	Ivory	5-20R	•	•	•
IG2636W	IG2636HW	20	125	White	5-20R	•	•	•
IG2636	IG2636HG	20	125	Orange	5-20R	•	•	•
IG2636GRY		20	125	Gray	5-20R	•	•	•
IG2636BK	IG2636HGBK	20	125	Black	5-20R	•	•	•
IG2636RED	IG2636HGRED	20	125	Red	5-20R	•	•	•
IG2636LA		20	125	Light Almond	5-20R	•	•	•
SINGLE RECEPTACLES BACK & SIDE WIRE								
IG5261		15	125	Orange	5-15R	•	•	•
IG5361	IG8301	20	125	Orange	5-20R	•	•	•

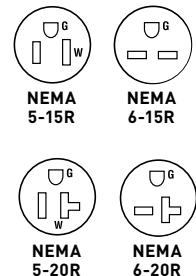

For Wall Plates for Isolated Ground Systems, consult Wall Plates Section 5.

For Bulk Packaging Solutions consult factory.

All devices listed on this page conform to NEMA WD-1 and WD-6.

STRAIGHT BLADE RECEPTACLES

Tamper-Resistant Isolated Ground Receptacles 2 Pole, 3 Wire Grounding 15 & 20A, 125V

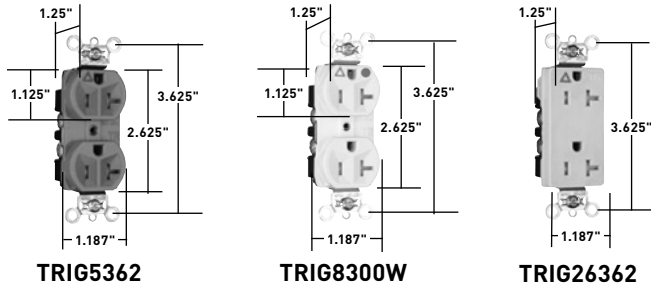

CATALOG NUMBER		RATING		COLOR	NEMA CONFIG. NO.	3rd PARTY COMPLIANCE	
SPEC GRADE	HOSPITAL GRADE	A.	V.			cUL ^{us} UL498	FSUL WC596
TAMPER-RESISTANT DUPLEX RECEPTACLES BACK & SIDE WIRE							
TRIG5262I	TRIG8200I	15	125	Ivory	5-15R	•	•
TRIG5262W	TRIG8200W	15	125	White	5-15R	•	•
TRIG5262	TRIG8200	15	125	Orange	5-15R	•	•
TRIG5262BK	TRIG8200BK	15	125	Black	5-15R	•	•
TRIG5262GRY	TRIG8200GRY	15	125	Gray	5-15R	•	•
	TRIG8200RED	15	125	Red	5-15R	•	•
TRIG5262LA	TRIG8200LA	15	125	Light Almond	5-15R	•	•
TRIG5362I	TRIG8300I	20	125	Ivory	5-20R	•	•
TRIG5362W	TRIG8300W	20	125	White	5-20R	•	•
TRIG5362	TRIG8300	20	125	Orange	5-20R	•	•
TRIG5362BK	TRIG8300BK	20	125	Black	5-20R	•	•
TRIG5362GRY	TRIG8300GRY	20	125	Gray	5-20R	•	•
TRIG5362RED	TRIG8300RED	20	125	Red	5-20R	•	•
TRIG5362LA	TRIG8300LA	20	125	Light Almond	5-20R	•	•
TAMPER-RESISTANT DECORATOR RECEPTACLES BACK & SIDE WIRE							
TRIG26262I	TRIG26262HGI	15	125	Ivory	5-15R	•	•
TRIG26262W	TRIG26262HGW	15	125	White	5-15R	•	•
TRIG26262		15	125	Orange	5-15R	•	•
TRIG26262BK	TRIG26262HGBK	15	125	Black	5-15R	•	•
TRIG26262GRY	TRIG26262HGGRY	15	125	Gray	5-15R	•	•
	TRIG26262HGRED	15	125	Red	5-15R	•	•
TRIG26262LA	TRIG26262HGLA	15	125	Light Almond	5-15R	•	•
TRIG26362I	TRIG26362HGI	20	125	Ivory	5-20R	•	•
TRIG26362W	TRIG26362HGW	20	125	White	5-20R	•	•
TRIG26362	TRIG26362HGI	20	125	Orange	5-20R	•	•
TRIG26362BK	TRIG26362HGBK	20	125	Black	5-20R	•	•
TRIG26362GRY	TRIG26362HGGRY	20	125	Gray	5-20R	•	•
	TRIG26362HGRED	20	125	Red	5-20R	•	•
TRIG26362LA	TRIG26362HGLA	20	125	Light Almond	5-20R	•	•

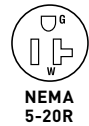
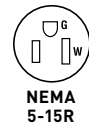

STRAIGHT BLADE RECEPTACLES

For Bulk Packaging Solutions consult factory.

STRAIGHT BLADE RECEPTACLES

the radiant[®]
collection

radiant[®] USB Chargers with Tamper-Resistant Receptacles 15A, 125V

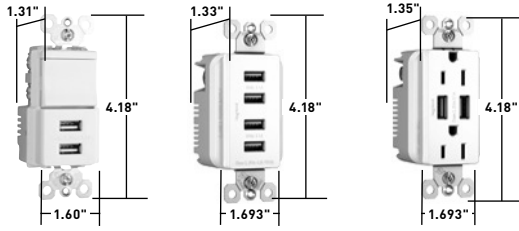

TM83USBW TM8USB4W TM826USBW

The radiant[®] collection is a step up from the standard with simple, classic options in wiring devices, home automation controls, and screwless wall plates that complement today's homes and hospitality settings.

Features

- Part of the radiant[®] collection.
- Charge multiple USB powered devices at the same time.
- Allow users to plug USB cables directly without AC adapters or transformer style plugs.
- Now with black "invisi-shutters" for an invisible effect preferred by end users.
- Back and side wire terminals.
- Compatible with USB 2.0 and 3.0 devices.
- Accepts standard Pass & Seymour wall plates and radiant[®] screwless wall plates (see pages S-6 and S-7).
- Compact design.
- All AC outlets are tamper-resistant.
- Meets NEC standards.

CATALOG NUMBER	RATING		COLOR	TOTAL CHARGING CAPACITY	3rd PARTY COMPLIANCE		
	A.	V.			UL1310	ETL	cULUS
USB CHARGERS WITH TAMPER-RESISTANT RECEPTACLE							
TM8USBICC6	15	125	Ivory	2.1 Amp		•	•
TM8USBW	15	125	White	2.1 Amp		•	•
TM8USBBK	15	125	Black	2.1 Amp		•	•
TM8USBLA	15	125	Light Almond	2.1 Amp		•	•
TM8USBNICC6	15	125	Nickel	2.1 Amp		•	•
USB CHARGERS WITH SINGLE POLE/3-WAY SWITCH							
TM83USBICC6	15	120	Ivory	2.1 Amp		•	•
TM83USBWCC6	15	120	White	2.1 Amp		•	•
TM83USBBKCC6	15	120	Black	2.1 Amp		•	•
TM83USBLACC6	15	120	Light Almond	2.1 Amp		•	•
TM83USBNICC6	15	120	Nickel	2.1 Amp		•	•
USB QUAD CHARGERS							
TM8USB4ICC6			Ivory	4.2 Amp	•		
TM8USB4WCC6			White	4.2 Amp	•		
TM8USB4BKCC6			Black	4.2 Amp	•		
TM8USB4LACC6			Light Almond	4.2 Amp	•		
TM8USB4GRYCC6			Gray	4.2 Amp	•		
TM8USB4NICC6			Nickel	4.2 Amp	•		

Features

- Overall 3.1A USB charging capability.
- Combination AC duplex receptacles include two 5-volt DC USB ports that work with USB 2.0 & 3.0 compatible devices.
- AC receptacles available in 15A, 125V.
- Now with black "invisi-shutters" for an invisible effect preferred by end users.
- AC receptacles are tamper-resistant to meet NEC Code – patented shutter system prevents improper insertion of foreign objects.
- Back and side wire terminals accommodate #14 AWG – #10 AWG stranded and solid copper wire.
- Multiple color options available.

CATALOG NUMBER	RATING		COLOR	TOTAL CHARGING CAPACITY	3rd PARTY COMPLIANCE		
	A.	V.			UL498 UL1310	cULUS	C22.2 No. 42 C22.2 No. 223
USB CHARGERS WITH DUPLEX DECORATOR TAMPER-RESISTANT RECEPTACLES							
TM826USBI	15	125	Ivory	3.1 Amp	•	•	•
TM826USBW	15	125	White	3.1 Amp	•	•	•
TM826USBK	15	125	Black	3.1 Amp	•	•	•
TM826USBLA	15	125	Light Almond	3.1 Amp	•	•	•
TM826USBNICC6	15	125	Nickel	3.1 Amp	•	•	•

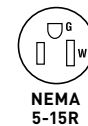

All devices listed on this page conform to NEMA WD-1 and WD-6.

STRAIGHT BLADE RECEPTACLES

Fed Spec & Hospital Grade USB Chargers with Tamper-Resistant Receptacles

2 Pole, 3 Wire Grounding 15 & 20A, 125V & 120V

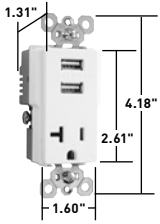

TR5361USBW

Features

- Compact-design Tamper-Resistant receptacle and two 5-volt DC USB ports that work with USB 2.0 & 3.0 compatible devices.
- 3.1A USB type A receptacle charges fast, eliminates the need for bulky AC adapters.
- Back and side wire terminals accommodate #14 AWG - #10 AWG stranded and solid wire.
- Zinc-plated ground terminal screw.
- Stainless steel auto-ground clip assures positive ground.
- Tamper-Resistant, patented shutter system prevents improper insertion of foreign objects. Meets National Electric Code® Tamper-Resistant requirements.

CATALOG NUMBER	RATING		COLOR	TOTAL CHARGING CAPACITY	3rd PARTY COMPLIANCE		
	A.	V.				UL498 UL1310	FSUL WC596
FED SPEC USB CHARGERS WITH TAMPER-RESISTANT RECEPTACLE							
TR5261USBI	15	125	Ivory	2.1 Amp	•	•	•
TR5261USBW	15	125	White	2.1 Amp	•	•	•
TR5261USB	15	125	Brown	2.1 Amp	•	•	•
TR5261USBGRY	15	125	Gray	2.1 Amp	•	•	•
TR5261USBBK	15	125	Black	2.1 Amp	•	•	•
TR5261USBLA	15	125	Light Almond	2.1 Amp	•	•	•
TR5361USBI	20	125	Ivory	2.1 Amp	•	•	•
TR5361USBW	20	125	White	2.1 Amp	•	•	•
TR5361USB	20	125	Brown	2.1 Amp	•	•	•
TR5361USBGRY	20	125	Gray	2.1 Amp	•	•	•
TR5361USBBK	20	125	Black	2.1 Amp	•	•	•
TR5361USBLA	20	125	Light Almond	2.1 Amp	•	•	•

STRAIGHT BLADE RECEPTACLES

UL Fed Spec & Hospital Grade USB Chargers 15 & 20A, 125V

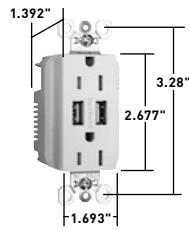

TR5262USBLA

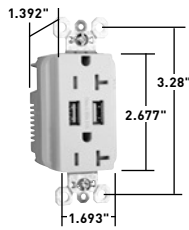

TR5362USBLA

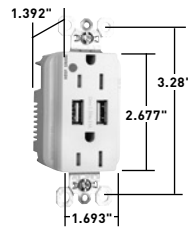

TR8200HUSBLA

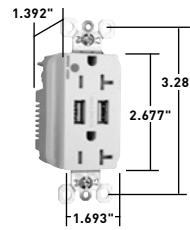

TR8300HUSBLA

Features

- Overall 3.1A USB charging capability
- Combination AC duplex receptacles include two 5-volt DC USB ports that work with USB 2.0 & 3.0 compatible devices
- Back and side wire terminals accommodate #14 AWG - #10 AWG stranded and solid copper wire.
- Stainless steel auto-ground clips assure positive ground
- AC receptacles are tamper-resistant as standard - patented shutter system prevents improper insertion of foreign objects

CATALOG NUMBER	RATING		COLOR	TOTAL CHARGING CAPACITY	NEMA CONFIG. NO.	3rd PARTY COMPLIANCE		
	A.	V.				C22.2 No. 42 C22.2 No. 223	FSUL WC596	UL US UL498 UL1310
DUPLIX TAMPER-RESISTANT RECEPTACLES WITH USB CHARGER								
TR5262USB	15	125	Brown	3.1 Amp	5-15R	•	•	•
TR5262USBW	15	125	White	3.1 Amp	5-15R	•	•	•
TR5262USBLA	15	125	Light Almond	3.1 Amp	5-15R	•	•	•
TR5262USBI	15	125	Ivory	3.1 Amp	5-15R	•	•	•
TR5262USBBK	15	125	Black	3.1 Amp	5-15R	•	•	•
TR5262USBGRY	15	125	Gray	3.1 Amp	5-15R	•	•	•
TR5262USBNI	15	125	Nickel	3.1 Amp	5-15R	•	•	•
TR5362USB	20	125	Brown	3.1 Amp	5-20R	•	•	•
TR5362USBW	20	125	White	3.1 Amp	5-20R	•	•	•
TR5362USBLA	20	125	Light Almond	3.1 Amp	5-20R	•	•	•
TR5362USBI	20	125	Ivory	3.1 Amp	5-20R	•	•	•
TR5362USBBK	20	125	Black	3.1 Amp	5-20R	•	•	•
TR5362USBGRY	20	125	Gray	3.1 Amp	5-20R	•	•	•
TR5362USBRED	20	125	Red	3.1 Amp	5-20R	•	•	•
TR5362USBNI	20	125	Nickel	3.1 Amp	5-20R	•	•	•
DUPLIX TAMPER-RESISTANT HOSPITAL GRADE RECEPTACLES WITH USB CHARGER								
TR8200HUSB	15	125	Brown	3.1 Amp	5-15R	•	•	•
TR8200HUSBW	15	125	White	3.1 Amp	5-15R	•	•	•
TR8200HUSBI	15	125	Ivory	3.1 Amp	5-15R	•	•	•
TR8200HUSBBK	15	125	Black	3.1 Amp	5-15R	•	•	•
TR8200HUSBGRY	15	125	Gray	3.1 Amp	5-15R	•	•	•
TR8200HUSBRED	15	125	Red	3.1 Amp	5-15R	•	•	•
TR8300HUSB	20	125	Brown	3.1 Amp	5-15R	•	•	•
TR8300HUSBW	20	125	White	3.1 Amp	5-20R	•	•	•
TR8300USBLA	20	125	Light Almond	3.1 Amp	5-20R	•	•	•
TR8300USBI	20	125	Ivory	3.1 Amp	5-20R	•	•	•
TR8300USBBK	20	125	Black	3.1 Amp	5-20R	•	•	•
TR8300HUSBGRY	20	125	Gray	3.1 Amp	5-20R	•	•	•
TR8300HUSBRED	20	125	Red	3.1 Amp	5-20R	•	•	•

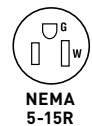

STRAIGHT BLADE RECEPTACLES

STRAIGHT BLADE RECEPTACLES

PlugTail® Tamper-Resistant Duplex, Hospital Grade & Split Circuit Receptacles 15 & 20A, 125V



PTTR26262I

Features

- Dual mechanical shutter system to help prevent insertion of foreign objects.
- .036 inch thick, brass, triple-wipe power contacts for lasting retention.
- Plated steel wrap-around strap design for maximum durability and corrosion resistance.
- No exposed terminals create a finger safe application before, during, and after installation.
- Built-in connector features large brass terminal blades to ensure consistent, reliable electrical connections.
- Crimped and welded contacts.
- Ultrasonically welded polycarbonate connector housing secures terminations and conductors in a UL Listed, finger safe housing.
- Large brass contacts snugly terminate on device blade terminals.
- Pre-stripped connector leads fasten to conductors, easier than standard pigtailed.
- Auto-ground clip assures positive ground.
- Split circuit models pre-wired with one welded pre-stripped wire lead to facilitate switched receptacle circuit applications.

CATALOG NUMBER SPEC GRADE	RATING		COLOR	NEMA CONFIG. NO.	3rd PARTY COMPLIANCE	
	A.	V.			cUL ^{us} UL498	FSUL WC596
TAMPER-RESISTANT DUPLEX RECEPTACLES						
PTTR26262W	15	125	White	5-15R	•	•
PTTR26262	15	125	Brown	5-15R	•	•
PTTR26262BK	15	125	Black	5-15R	•	•
PTTR26262LA	15	125	Light Almond	5-15R	•	•
PTTR26362I	20	125	Ivory	5-20R	•	•
PTTR26362W	20	125	White	5-20R	•	•
PTTR26362	20	125	Brown	5-20R	•	•
PTTR26362BK	20	125	Black	5-20R	•	•
PTTR26362LA	20	125	Light Almond	5-20R	•	•
TAMPER-RESISTANT HOSPITAL GRADE DUPLEX RECEPTACLES						
PTTR26262HGI	15	125	Ivory	5-15R	•	•
PTTR26262HGW	15	125	White	5-15R	•	•
PTTR26262HGRED	15	125	Red	5-15R	•	•
PTTR26362HGI	20	125	Ivory	5-20R	•	•
PTTR26362HGW	20	125	White	5-20R	•	•
PTTR26362HGGRY	20	125	Gray	5-20R	•	•
PTTR26362HGRED	20	125	Red	5-20R	•	•
PTTR26362HGLA	20	125	Light Almond	5-20R	•	•
TAMPER-RESISTANT SPLIT CIRCUIT DUPLEX RECEPTACLES						
PTTR26262SCI	15	125	Ivory	5-15R	•	•
PTTR26262SCW	15	125	White	5-15R	•	•
PTTR26262SCBK	15	125	Black	5-15R	•	•
PTTR26362SCW	20	125	White	5-20R	•	•
PTTR26362SC	20	125	Brown	5-20R	•	•
PTTR26362SCLA	20	125	Light Almond	5-20R	•	•



STRAIGHT BLADE RECEPTACLES

STRAIGHT BLADE RECEPTACLES

PlugTail® Decorator Receptacles 15 & 20A, 125V

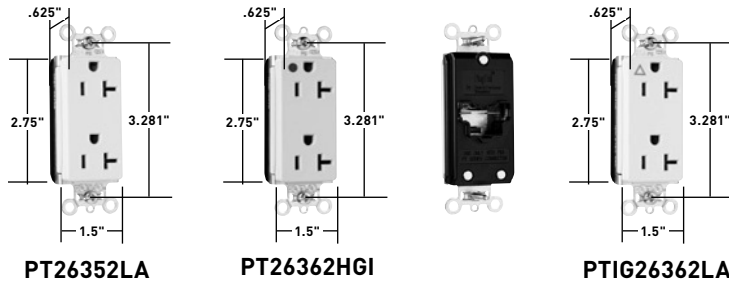

Features

- .036 inch thick, brass, triple-wipe power contacts for lasting retention.
- Plated steel wrap-around strap design for maximum durability and corrosion resistance.
- No exposed terminals create a finger safe application before, during, and after installation.
- Built-in connector features large brass terminal blades to ensure consistent, reliable electrical connections.
- Crimped and welded contacts.
- Ultrasonically welded polycarbonate connector housing secures terminations and conductors in a UL Listed, finger safe housing.
- Large brass contacts snugly terminate on device blade terminals.
- Pre-stripped connector leads fasten to conductors, easier than standard pigtailed.
- Auto-ground clip assures positive ground.
- Isolated ground version features nylon isolator plate for isolating ground from strap and box system.

CATALOG NUMBER	RATING		COLOR	NEMA CONFIG. NO.	3rd PARTY COMPLIANCE	
	A.	V.			cUL ^{us} UL498	FSUL WC596
DUPLEX RECEPTACLES						
PT26252W	15	125	White	5-15R	•	•
PT26252	15	125	Brown	5-15R	•	•
PT26252GRY	15	125	Gray	5-15R	•	•
PT26252BK	15	125	Black	5-15R	•	•
PT26252RED	15	125	Red	5-15R	•	•
PT26252LA	15	125	Light Almond	5-15R	•	•
PT26352I	20	125	Ivory	5-20R	•	•
PT26352W	20	125	White	5-20R	•	•
PT26352	20	125	Brown	5-20R	•	•
PT26352GRY	20	125	Gray	5-20R	•	•
PT26352BK	20	125	Black	5-20R	•	•
PT26352RED	20	125	Red	5-20R	•	•
PT26352LA	20	125	Light Almond	5-20R	•	•
PT26352BL	20	125	Blue	5-20R	•	•
HOSPITAL GRADE DUPLEX RECEPTACLES						
PT26262HGI	15	125	Ivory	5-15R	•	•
PT26262HGW	15	125	White	5-15R	•	•
PT26262HGRE	15	125	Red	5-15R	•	•
PT26362HGI	20	125	Ivory	5-20R	•	•
PT26362HGW	20	125	White	5-20R	•	•
PT26362HGGRY	20	125	Gray	5-20R	•	•
PT26362HGRE	20	125	Red	5-20R	•	•
PT26362HGCLA	20	125	Light Almond	5-20R	•	•
ISOLATED GROUND DUPLEX RECEPTACLES						
PTIG26262W	15	125	White	5-15R	•	•
PTIG26262	15	125	Orange	5-15R	•	•
PTIG26262RED	15	125	Red	5-15R	•	•
PTIG26362I	20	125	Ivory	5-20R	•	•
PTIG26362W	20	125	White	5-20R	•	•
PTIG26362	20	125	Orange	5-20R	•	•
PTIG26362GRY	20	125	Gray	5-20R	•	•

2 Pole, 3 Wire

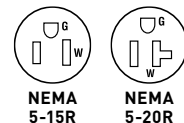

For PlugTail Connectors, see Page B-4.

For Bulk Packaging Solutions consult factory.

All devices listed on this page conform to NEMA WD-1 and WD-6.

STRAIGHT BLADE RECEPTACLES

Heavy-Duty Hospital Grade Decorator Receptacles 15 & 20A, 125V

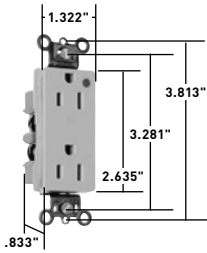

26262HGI

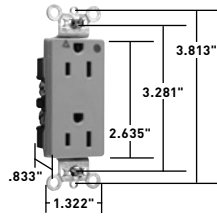

IG26262HG

Features

- Corrosion-resistant, plated steel strap locked into assembly to prohibit strap from bending away from body.
- One-piece, brass, triple-wipe power contacts for lasting retention.
- Heavy-duty compact design for easier installation and long lasting performance.
- Isolated ground version features nylon isolator plate for isolating ground strap and box system.
- Easily accessed break-off, line-contact connecting tab for fast, easy split-circuit wiring.
- Impact-resistant nylon face.
- Terminal compartments isolated from each other for positive conductor containment.
- Side and internal screw-pressure-plate back wire accepts #14 – #10 AWG solid or stranded wire.
- All devices fit standard Decorator-style wall plate.
- Tri-drive terminal and mounting screws.
- Auto-ground clip assures positive ground.

CATALOG NUMBER	RATING		COLOR	NEMA CONFIG. NO.	3rd PARTY COMPLIANCE		
	A.	V.			UL498	FSUL WC596	cUL/CSA
HOSPITAL GRADE DUPLEX RECEPTACLES BACK & SIDE WIRE							
26262HGI	15	125	Ivory	5-15R	•	•	•
26262HGW	15	125	White	5-15R	•	•	•
26262HGGRY	15	125	Gray	5-15R	•	•	•
26262HGRED	15	125	Red	5-15R	•	•	•
26362HGI	20	125	Ivory	5-20R	•	•	•
26362HGW	20	125	White	5-20R	•	•	•
26362HG	20	125	Brown	5-20R	•	•	•
26362HGGRY	20	125	Gray	5-20R	•	•	•
26362HGRED	20	125	Red	5-20R	•	•	•
26362HGLA	20	125	Light Almond	5-20R	•	•	•
HOSPITAL GRADE ISOLATED GROUND DUPLEX RECEPTACLES BACK & SIDE WIRE							
IG26262HGW	15	125	White	5-15R	•		•
IG26262HG	15	125	Orange	5-15R	•		•
IG26262HGRED	15	125	Red	5-15R	•		•
IG26362HGW	20	125	White	5-20R	•		•
IG26362HG	20	125	Orange	5-20R	•		•
IG26362HGBK	20	125	Black	5-20R	•		•
IG26362HGRED	20	125	Red	5-20R	•		•

2 Pole, 3 Wire

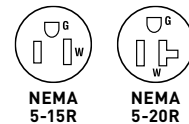

STRAIGHT BLADE RECEPTACLES

For Bulk Packaging Solutions consult factory.

STRAIGHT BLADE RECEPTACLES

Specification Grade Decorator Receptacles 15 & 20A, 125 & 250V

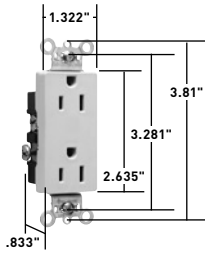

262421

Features

- Corrosion-resistant, plated steel strap locked into assembly to prohibit strap from bending away from body.
- One-piece, brass, triple-wipe power contacts for lasting retention.
- Heavy-duty compact design for easier installation and long lasting performance.
- Easily accessed break-off, line-contact connecting tab for fast, easy split-circuit wiring.
- Impact-resistant nylon face.
- Terminal compartments isolated from each other for positive conductor containment.
- Side wire accepts #14 – #10 AWG solid or stranded wire.
- All devices fit standard Decorator-style wall plate.
- Tri-drive terminal and mounting screws.
- Auto-ground clip assures positive ground.

CATALOG NUMBER	RATING		COLOR	NEMA CONFIG. NO.	3rd PARTY COMPLIANCE		
	A.	V.			UL498	FSUL WC596	cUL/CSA
DUPLEX RECEPTACLES SIDE WIRE ONLY							
262421	15	125	Ivory	5-15R	•	•	•
26242W	15	125	White	5-15R	•	•	•
26242	15	125	Brown	5-15R	•	•	•
26242GRY	15	125	Gray	5-15R	•	•	•
26242BK	15	125	Black	5-15R	•	•	•
26242RED	15	125	Red	5-15R	•	•	•
263421	20	125	Ivory	5-20R	•	•	•
26342W	20	125	White	5-20R	•	•	•
26342	20	125	Brown	5-20R	•	•	•
26342GRY	20	125	Gray	5-20R	•	•	•
26342BK	20	125	Black	5-20R	•	•	•
26342RED	20	125	Red	5-20R	•	•	•

2 Pole, 3 Wire

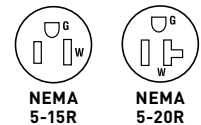

For Bulk Packaging Solutions consult factory.

All devices listed on this page conform to NEMA WD-1 and WD-6.

STRAIGHT BLADE RECEPTACLES

Heavy-Duty Specification Grade Decorator Receptacles 15 & 20A, 125 & 250V

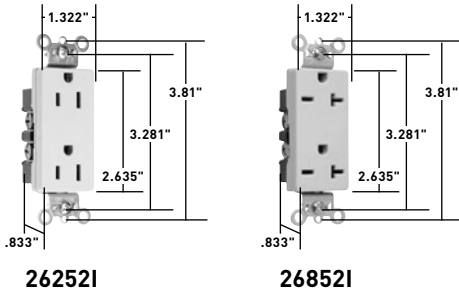

Features

- Corrosion-resistant, plated steel strap locked into assembly to prohibit strap from bending away from body.
- One-piece, brass, triple-wipe power contacts for lasting retention.
- Heavy-duty compact design for easier installation and long lasting performance.
- Easily accessed break-off, line-contact connecting tab for fast, easy split-circuit wiring.
- Impact-resistant nylon face.
- Terminal compartments isolated from each other for positive conductor containment.
- Side and internal screw-pressure-plate back wire accepts #14 – #10 AWG solid or stranded wire.
- All devices fit standard Decorator-style wall plate.
- Tri-drive terminal and mounting screws.
- Auto-ground clip assures positive ground.

CATALOG NUMBER	RATING		COLOR	NEMA CONFIG. NO.	3rd PARTY COMPLIANCE		
	A.	V.			UL498	FSUL WC596	cUL/CSA
SPECIFICATION GRADE DUPLEX RECEPTACLES BACK & SIDE WIRE							
26252I	15	125	Ivory	5-15R	•	•	•
26252W	15	125	White	5-15R	•	•	•
26252	15	125	Brown	5-15R	•	•	•
26252GRY	15	125	Gray	5-15R	•	•	•
26252BK	15	125	Black	5-15R	•	•	•
26252RED	15	125	Red	5-15R	•	•	•
26252LA	15	125	Light Almond	5-15R	•	•	•
26352I	20	125	Ivory	5-20R	•	•	•
26352W	20	125	White	5-20R	•	•	•
26352	20	125	Brown	5-20R	•	•	•
26352GRY	20	125	Gray	5-20R	•	•	•
26352BK	20	125	Black	5-20R	•	•	•
26352RED	20	125	Red	5-20R	•	•	•
26352LA	20	125	Light Almond	5-20R	•	•	•

CATALOG NUMBER	RATING		COLOR	NEMA CONFIG. NO.	3rd PARTY COMPLIANCE		
	A.	V.			UL498	FSUL WC596	cUL/CSA
DUPLEX RECEPTACLES BACK & SIDE WIRE							
26652I	15	250	Ivory	6-15R	•	•	•
26652W	15	250	White	6-15R	•	•	•
26652BK	15	250	Black	6-15R	•	•	•
26852I	20	250	Ivory	6-20R	•	•	•
26852W	20	250	White	6-20R	•	•	•
26852	20	250	Brown	6-20R	•	•	•
26852BK	20	250	Black	6-20R	•	•	•
26852RED	20	250	Red	6-20R	•	•	•
26852LA	20	250	Light Almond	6-20R	•	•	•

2 Pole, 3 Wire

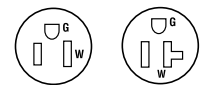

NEMA 5-15R NEMA 5-20R

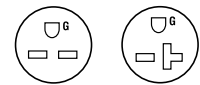

NEMA 6-15R NEMA 6-20R

STRAIGHT BLADE RECEPTACLES

For Bulk Packaging Solutions consult factory.

STRAIGHT BLADE RECEPTACLES

Commercial Specification Grade Receptacles Tamper-Resistant 15 & 20A, 125V

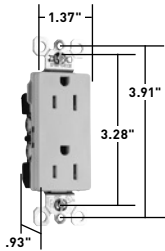

TR26242I

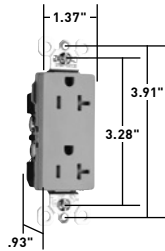

TR26352GRY

Features

- Dual mechanical shutter system to help prevent insertion of foreign objects.
- Impact-resistant nylon face for durability.
- .032-inch thick brass triple-wipe power contacts for reliable plug retention.
- Auto-ground clip assures positive ground.
- Corrosion-resistant, plated steel strap.
- Easily accessed break-off, line-contact connecting tab for fast, easy split-circuit wiring.
- Backed-out tri-drive steel terminal screws for faster installation.

CATALOG NUMBER	RATING		COLOR	NEMA CONFIG. NO.	3rd PARTY COMPLIANCE	
	A.	V.			UL498	C22.2 No. 42
DUPLEX RECEPTACLES SIDE WIRE						
TR26242I	15	125	Ivory	5-15R	•	•
TR26242W	15	125	White	5-15R	•	•
TR26242	15	125	Brown	5-15R	•	•
TR26242GRY	15	125	Gray	5-15R	•	•
TR26242BK	15	125	Black	5-15R	•	•
TR26242LA	15	125	Light Almond	5-15R	•	•
TR26342I	20	125	Ivory	5-20R	•	•
TR26342W	20	125	White	5-20R	•	•
TR26342	20	125	Brown	5-20R	•	•
TR26342GRY	20	125	Gray	5-20R	•	•
TR26342BK	20	125	Black	5-20R	•	•
TR26342LA	20	125	Light Almond	5-20R	•	•
DUPLEX RECEPTACLES BACK & SIDE WIRE						
TR26252I	15	125	Ivory	5-15R	•	•
TR26252W	15	125	White	5-15R	•	•
TR26252	15	125	Brown	5-15R	•	•
TR26252GRY	15	125	Gray	5-15R	•	•
TR26252BK	15	125	Black	5-15R	•	•
TR26252LA	15	125	Light Almond	5-15R	•	•
TR26352I	20	125	Ivory	5-20R	•	•
TR26352W	20	125	White	5-20R	•	•
TR26352	20	125	Brown	5-20R	•	•
TR26352GRY	20	125	Gray	5-20R	•	•
TR26352BK	20	125	Black	5-20R	•	•
TR26352LA	20	125	Light Almond	5-20R	•	•

2 Pole, 3 Wire

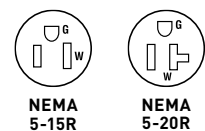

STRAIGHT BLADE RECEPTACLES

For Bulk Packaging Solutions consult factory.

All devices listed on this page conform to NEMA WD-1 and WD-6.

STRAIGHT BLADE RECEPTACLES

Heavy-Duty Tamper-Resistant Decorator Receptacles 15 & 20A, 125V

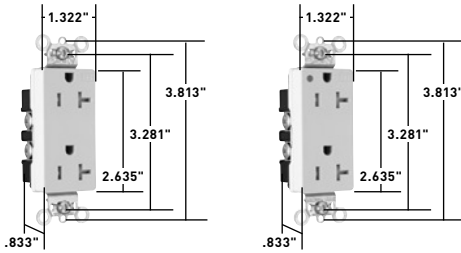

TR26362I

TR26362HGI

Features

- Isolated ground version features nylon isolator plate for isolating ground strap and box system.
- Auto-ground clip assures positive ground.
- Dual mechanical shutter system to help prevent insertion of foreign objects.
- One-piece brass triple-wipe power contacts for reliable plug retention.
- Two drive screws anchor strap to back body and face where abrupt removal torque is strongest.
- Patented external screw-pressure-plate back wire clamp on ground terminal for faster, easier installation.
- Easily accessed break-off, line-contact connecting tab for fast, easy split-circuit wiring.
- External screw-pressure-plate back wire clamps with #10 brass terminal screws for visual assurance of a good connection.
- One-piece plated steel mounting strap with integral ground for superior long-term performance.

CATALOG NUMBER	RATING		COLOR	NEMA CONFIG. NO.	3rd PARTY COMPLIANCE		
	A.	V.			UL498	FSUL WC596	cUL/CSA
TAMPER-RESISTANT DECORATOR DUPLEX RECEPTACLES BACK & SIDE WIRE							
TR26262I	15	125	Ivory	5-15R	•	•	•
TR26262W	15	125	White	5-15R	•	•	•
TR26262	15	125	Brown	5-15R	•	•	•
TR26262GRY	15	125	Gray	5-15R	•	•	•
TR26262BK	15	125	Black	5-15R	•	•	•
TR26262RED	15	125	Red	5-15R	•	•	•
TR26262LA	15	125	Light Almond	5-15R	•	•	•
TR26362I	20	125	Ivory	5-20R	•	•	•
TR26362W	20	125	White	5-20R	•	•	•
TR26362	20	125	Brown	5-20R	•	•	•
TR26362GRY	20	125	Gray	5-20R	•	•	•
TR26362BK	20	125	Black	5-20R	•	•	•
TR26362RED	20	125	Red	5-20R	•	•	•
TR26362LA	20	125	Light Almond	5-20R	•	•	•
TAMPER-RESISTANT HOSPITAL GRADE DUPLEX RECEPTACLES BACK & SIDE WIRE							
TR26262HGI	15	125	Ivory	5-15R	•	•	•
TR26262HGW	15	125	White	5-15R	•	•	•
TR26262HGGRY	15	125	Gray	5-15R	•	•	•
TR26262HGRED	15	125	Red	5-15R	•	•	•
TR26262HGCLA	15	125	Light Almond	5-15R	•	•	•
TR26362HGI	20	125	Ivory	5-20R	•	•	•
TR26362HGW	20	125	White	5-20R	•	•	•
TR26362HGGRY	20	125	Gray	5-20R	•	•	•
TR26362HGBK	20	125	Black	5-20R	•	•	•
TR26362HGRED	20	125	Red	5-20R	•	•	•
TR26362HGCLA	20	125	Light Almond	5-20R	•	•	•

2 Pole, 3 Wire

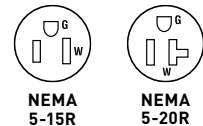

STRAIGHT BLADE RECEPTACLES

For Bulk Packaging Solutions consult factory.

STRAIGHT BLADE RECEPTACLES

Heavy-Duty Tamper-Resistant Decorator Single Receptacles 15 & 20A, 125V

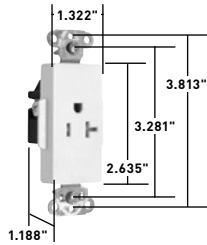

TR26361LA

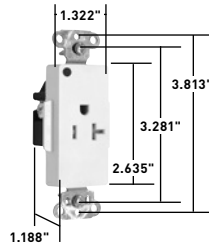

TR26361HGLA

Features

- Auto-ground clip assures positive ground.
- Backed-out tri-drive brass terminal screws for faster installation. Internal screw-pressure-plate back and side wire capability. Two back wire holes for additional wiring flexibility.
- Heavy-duty corrosion-resistant zinc-plated strap for added strength.
- One-piece brass triple-wipe power contact for lasting retention.
- Two drive screws anchor steel strap to back body and face where abrupt removal torque is greatest.
- Dual mechanical shutter system to help prevent insertion of foreign objects.

CATALOG NUMBER	RATING		COLOR	NEMA CONFIG. NO.	3rd PARTY COMPLIANCE		
	A.	V.			UL498	FSUL WC596	C22.2 No. 42
HEAVY-DUTY TAMPER-RESISTANT DECORATOR SINGLE RECEPTACLES BACK & SIDE WIRE							
TR26261I	15	125	Ivory	5-15R	•	•	•
TR26261W	15	125	White	5-15R	•	•	•
TR26261	15	125	Brown	5-15R	•	•	•
TR26261GRY	15	125	Gray	5-15R	•	•	•
TR26261BK	15	125	Black	5-15R	•	•	•
TR26261LA	15	125	Light Almond	5-15R	•	•	•
TR26361I	20	125	Ivory	5-20R	•	•	•
TR26361W	20	125	White	5-20R	•	•	•
TR26361	20	125	Brown	5-20R	•	•	•
TR26361GRY	20	125	Gray	5-20R	•	•	•
TR26361BK	20	125	Black	5-20R	•	•	•
TR26361LA	20	125	Light Almond	5-20R	•	•	•
HEAVY-DUTY TAMPER-RESISTANT DECORATOR HOSPITAL GRADE SINGLE RECEPTACLES BACK & SIDE WIRE							
TR26261HGI	15	125	Ivory	5-15R	•	•	•
TR26261HGW	15	125	White	5-15R	•	•	•
TR26261HG	15	125	Brown	5-15R	•	•	•
TR26261HGGRY	15	125	Gray	5-15R	•	•	•
TR26261HGBK	15	125	Black	5-15R	•	•	•
TR26261HGLA	15	125	Light Almond	5-15R	•	•	•
TR26361HGI	20	125	Ivory	5-20R	•	•	•
TR26361HGW	20	125	White	5-20R	•	•	•
TR26361HG	20	125	Brown	5-20R	•	•	•
TR26361HGGRY	20	125	Gray	5-20R	•	•	•
TR26361HGBK	20	125	Black	5-20R	•	•	•
TR26361HGLA	20	125	Light Almond	5-20R	•	•	•

2 Pole, 3 Wire

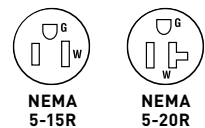

For Bulk Packaging Solutions consult factory.

All devices listed on this page conform to NEMA WD-1 and WD-6.

STRAIGHT BLADE RECEPTACLES

Specification Grade Decorator & Combination Receptacles 15 & 20A, 125 & 250V; 20A, 120/125VAC

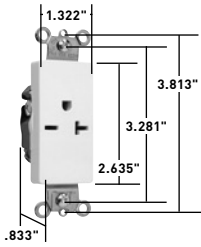

26861LA

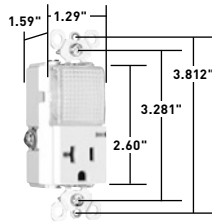

PS8HWLLA

Features

- Corrosion-resistant, plated wraparound steel strap locked into assembly to prohibit strap from bending away from body.
- One-piece, brass, triple-wipe power contacts for lasting retention.
- Heavy-duty compact design for easier installation and long lasting performance.
- Easily accessed break-off, line-contact connecting tab for fast, easy split-circuit wiring.
- Impact-resistant nylon face.
- Terminal compartments isolated from each other for positive conductor containment.
- Side and internal screw-pressure-plate back wire accepts #14 – #10 AWG solid or stranded wire.
- All devices fit standard Decorator-style wall plate.
- Tri-drive terminal and mounting screws.
- Auto-ground clip assures positive ground.

CATALOG NUMBER	RATING		COLOR	NEMA CONFIG. NO.	3rd PARTY COMPLIANCE		
	A.	V.			UL498	FSUL WC596	cUL/CSA
HEAVY-DUTY SPECIFICATION GRADE SINGLE RECEPTACLES BACK & SIDE WIRE							
266611	15	250	Ivory	6-15R	•	•	•
26661W	15	250	White	6-15R	•	•	•
26661GRY	15	250	Gray	6-15R	•	•	•
26661BK	15	250	Black	6-15R	•	•	•
268611	20	250	Ivory	6-20R	•	•	•
26861W	20	250	White	6-20R	•	•	•
26861	20	250	Brown	6-20R	•	•	•
26861GRY	20	250	Gray	6-20R	•	•	•
26861BK	20	250	Black	6-20R	•	•	•
26861LA	20	250	Light Almond	6-20R	•	•	•

Features

- Impact-resistant face and body.
- GE Lexan™ high impact-resistant lens.
- External screw-pressure-plate back and side wired. Accepts #12 and #14 AWG.
- Ground screw position under the end of the strap minimizes the risk of contact.
- Energy-efficient LED has average 20-year life expectancy; eliminates bulb replacement.
- Sensor automatically turns light ON in the dark.
- Increased light output for better illumination.
- Light sensor for enhanced sensitivity.

CATALOG NUMBER	RATING		LIGHT OUTPUT IN 1' FCD*	COLOR	NEMA CONFIG. NO.	3rd PARTY COMPLIANCE
	A.	VAC				UL498
SPECIFICATION GRADE DECORATOR HALLWAY LIGHT & SINGLE RECEPTACLE						
PS8HWLW	20	120/125	0.2561	White	5-20R	•
PS8HWLLA	20	120/125	0.2561	Light Almond	5-20R	•

*FCD = Foot Candle Distance. 1 Lumen = 1 FCD. See Page U-68 for more information.

2 Pole, 3 Wire



NEMA 5-20R



NEMA 6-15R



NEMA 6-20R

For Bulk Packaging Solutions consult factory.

STRAIGHT BLADE RECEPTACLES

TradeMaster® Tamper-Resistant Receptacles

3232TRW

TradeMaster® Tamper-Resistant Receptacles

Meets National Electrical Code® Tamper-Resistant requirements.

- A. High-impact resistant thermoplastic construction.
- B. Low profile face.
- C. Side wire accepts #12 – #14 AWG solid wire. Push wire accepts #14 AWG solid only.
- D. “TR” markings on strap per UL Tamper-Resistant requirements.
- E. Patented internal shutter system lets plugs in, but keeps keys and other objects out with automatic shutters that block access.
- F. Traditional contoured face.
- G. Safer and more effective than traditional plastic outlet caps or protection plates.

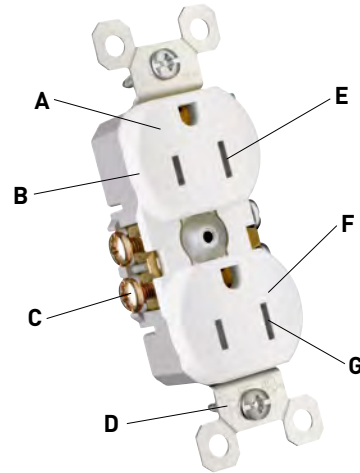

3232TRW

National Electrical Code® Section 406.11 Tamper-Resistant Receptacles in Dwelling Units.

In all areas specified in 210.52 all 125-volt, 15- and 20-amp receptacles shall be listed tamper-resistant receptacles.

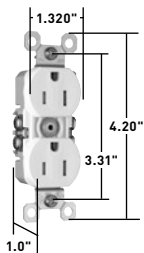

3232TRW

Features

- Extra-long strap.
- Quickloop wire looping aid.
- Long-term blade retention.
- Longer tri-drive screws for easier #12 AWG looping.
- Extra-large circuit break-off tabs.
- Side-access push wire release.
- Ultrasonic welding of face to back body.
- Traditional contoured face (3232 models).
- Self-grounding models provide automatic ground clip.

CATALOG NUMBER	RATING		COLOR	NEMA CONFIG. NO.	3rd PARTY COMPLIANCE		
	A.	V.			UL498	C22.2 No. 42	cULus
TAMPER-RESISTANT DUPLEX RECEPTACLES – GROUNDING							
3232TRI	15	125	Ivory	5-15R	•	•	•
3232TRW	15	125	White	5-15R	•	•	•
3232TR	15	125	Brown	5-15R	•	•	•
3232TRBK	15	125	Black	5-15R	•	•	•
3232TRLA	15	125	Light Almond	5-15R	•	•	•
SELF-GROUNDING TAMPER-RESISTANT DUPLEX RECEPTACLES							
3232TRSI	15	125	Ivory	5-15R	•	•	•
3232TRSW	15	125	White	5-15R	•	•	•
3232TRS	15	125	Brown	5-15R	•	•	•
3232TRSLA	15	125	Light Almond	5-15R	•	•	•
NAFTA-COMPLIANT TRADEMASTER® TAMPER-RESISTANT 15 AMP DUPLEX RECEPTACLES							
3232TRNAI	15	125	Ivory	5-15R	•	•	•
3232TRNAW	15	125	White	5-15R	•	•	•
3232TRNA	15	125	Brown	5-15R	•	•	•
3232TRNABK	15	125	Black	5-15R	•	•	•
3232TRNALA	15	125	Light Almond	5-15R	•	•	•

2 Pole, 3 Wire



NEMA 5-15R

NAFTA-Compliant Receptacles are ideal for use on projects subject to the provisions of the Buy American Act.

All devices listed on this page conform to NEMA WD-1 and WD-6.

STRAIGHT BLADE RECEPTACLES

radiant® Tamper-Resistant Receptacles 15A, 125V

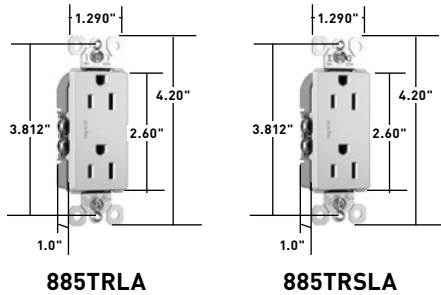

The radiant® collection is a step up from the standard with simple, classic options in wiring devices, home automation controls, and screwless wall plates that complement today's homes and hospitality settings.

Features

- Part of the radiant® collection.
- Meets National Electrical Code® Tamper-Resistant requirements.
- Protects children: patented shutter system — now with black “invisi-shutters” that disappear for an invisible effect — helps prevent improper insertion of foreign objects.
- Now with black “invisi-shutters” for an invisible effect preferred by end users.
- High-impact resistant thermoplastic construction.
- Extra-long strap.
- Quickloop wire looping aid.
- Long-term blade retention.
- Longer tri-drive screws for easier 12 AWG looping.
- Extra-large circuit break-off tabs.
- Side-access push wire release.
- Ultrasonic welding of face to back body.
- Side wire accepts #12 – #14 AWG solid wire.
- Push wire accepts #14 AWG solid only.
- Superior protection than traditional outlet “caps” or “protection plates.”
- Low profile face.
- Self-grounding models provide automatic ground clip.

CATALOG NUMBER	RATING		COLOR	NEMA CONFIG. NO.	3rd PARTY COMPLIANCE		
	A.	V.			UL498	C22.2 No. 42	cULus
TAMPER-RESISTANT RECEPTACLES							
885TRI	15	125	Ivory	5-15R	•	•	•
885TRW	15	125	White	5-15R	•	•	•
885TR	15	125	Brown	5-15R	•	•	•
885TRGRY	15	125	Gray	5-15R	•	•	•
885TRBK	15	125	Black	5-15R	•	•	•
885TRLA	15	125	Light Almond	5-15R	•	•	•
885TRNICC12	15	125	Nickel	5-15R	•	•	•
885TRABCC12	15	125	Antique Brass	5-15R	•	•	•
885TRDBCC12	15	125	Dark Bronze	5-15R	•	•	•
SELF-GROUNDING TAMPER-RESISTANT RECEPTACLES							
885TRSI	15	125	Ivory	5-15R	•	•	•
885TRSW	15	125	White	5-15R	•	•	•
885TRSLA	15	125	Light Almond	5-15R	•	•	•
NAFTA-COMPLIANT TAMPER-RESISTANT 15 AMP RECEPTACLE							
885TRNAI	15	125	Ivory	5-15R	•	•	•
885TRNAW	15	125	White	5-15R	•	•	•
885TR	15	125	Brown	5-15R	•	•	•
885TRNAGRY	15	125	Gray	5-15R	•	•	•
885TRBK	15	125	Black	5-15R	•	•	•
885TRNALA	15	125	Light Almond	5-15R	•	•	•

2 Pole, 3 Wire

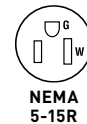

STRAIGHT BLADE RECEPTACLES

NAFTA-Compliant Receptacles are ideal for use on projects subject to the provisions of the Buy American Act.

STRAIGHT BLADE RECEPTACLES

Weather-Resistant Receptacles

3232TRWRW

Weather-Resistant Receptacles

Residential Weather-Resistant Receptacles are Tamper-Resistant as required by National Electrical Code®

- A. High-impact resistant thermoplastic construction.
- B. Low profile face.
- C. Side wire accepts #12 – #14 AWG solid wire. Push wire accepts #14 AWG solid only.
- D. “TR” markings identify devices as Tamper-Resistant.
- E. “WR” markings on face per UL Weather-Resistant requirements.
- F. Traditional contoured face.
- G. Patented internal shutter system lets plugs in, but keeps keys and other objects out with automatic shutters that block access.
- H. Safer and more effective than plastic outlet caps.

National Electrical Code® Section 406.8 Receptacles in Wet or Damp Locations.

Requires that all 15- and 20-amp, 125- and 250-volt non-locking receptacles installed in wet or damp locations shall be weather-resistant receptacles.

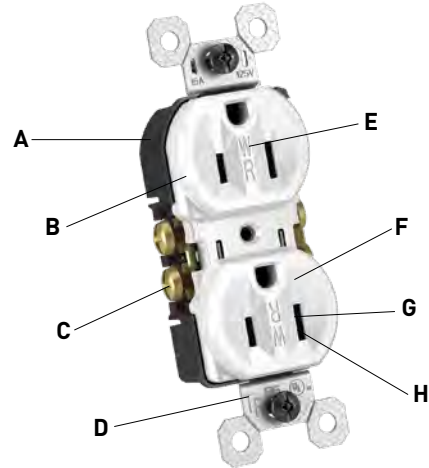

3232TRWRW

Listed to the Weather-Resistant supplement of UL498, meeting demanding UL requirements including:

- Ultraviolet light exposure test
- Cold impact test
- Accelerated aging test
- Stringent material requirements for current-carrying parts, wire binding screws and mounting straps to ensure superior corrosion resistance.

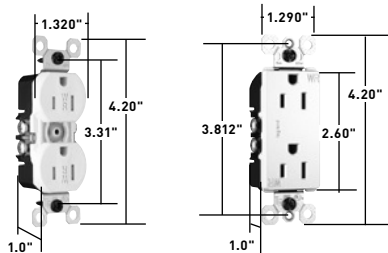

3232TRWRW

885TRWRLA

the radiant® collection

Features

- Specifically designed for increased protection of children in the home.
- Extra-long strap.
- Long-term blade retention.
- Quickloop wire looping aid.

CATALOG NUMBER	RATING		COLOR	NEMA CONFIG. NO.	3rd PARTY COMPLIANCE		
	A.	V.			UL498	C22.2 No. 42	cULus
WEATHER-RESISTANT DUPLEX RECEPTACLES							
3232TRWRI	15	125	Ivory	5-15R	•	•	•
3232TRWRW	15	125	White	5-15R	•	•	•
3232TRWR	15	125	Brown	5-15R	•	•	•
3232TRWRGRY	15	125	Gray	5-15R	•	•	•
3232TRWRLA	15	125	Light Almond	5-15R	•	•	•
RADIANT® WEATHER-RESISTANT DUPLEX RECEPTACLES							
885TRWRI	15	125	Ivory	5-15R	•	•	•
885TRWRW	15	125	White	5-15R	•	•	•
885TRWR	15	125	Brown	5-15R	•	•	•
885TRWRLA	15	125	Light Almond	5-15R	•	•	•

2 Pole, 3 Wire

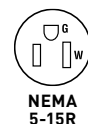

STRAIGHT BLADE RECEPTACLES

radiant® Receptacles 15A, 125V

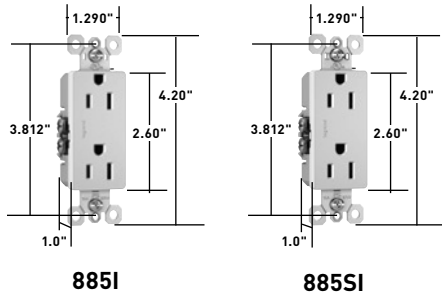

The radiant® collection is a step up from the standard with simple, classic options in wiring devices, home automation controls, and screwless wall plates that complement today's homes and hospitality settings.

Features

- Part of the radiant® collection.
- High impact-resistant thermoplastic construction.
- Extra-long strap.
- Quickloop wire looping aid.
- Long-term blade retention.
- Tri-drive screws.
- Extra-large circuit break-off tabs.
- Side-access push wire release.
- Ultrasonic welding of face to back body.
- Side wire accepts #12 – #14 AWG solid.
- Push wire accepts #14 AWG solid only.
- Self-grounding models provide automatic ground clip.

CATALOG NUMBER	RATING		COLOR	NEMA CONFIG. NO.	3rd PARTY COMPLIANCE	
	A.	V.			UL498	C22.2 No. 42
RADIANT® DUPLEX RECEPTACLES						
885I	15	125	Ivory	5-15R	•	•
885W	15	125	White	5-15R	•	•
885	15	125	Brown	5-15R	•	•
885BK	15	125	Black	5-15R	•	•
885GRY	15	125	Gray	5-15R	•	•
885LA	15	125	Light Almond	5-15R	•	•
SELF-GROUNDING RADIANT® DUPLEX RECEPTACLES						
885SI	15	125	Ivory	5-15R	•	•
885SW	15	125	White	5-15R	•	•
885SLA	15	125	Light Almond	5-15R	•	•

2 Pole, 3 Wire

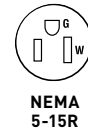

STRAIGHT BLADE RECEPTACLES

TradeMaster® Receptacles 15A, 125V

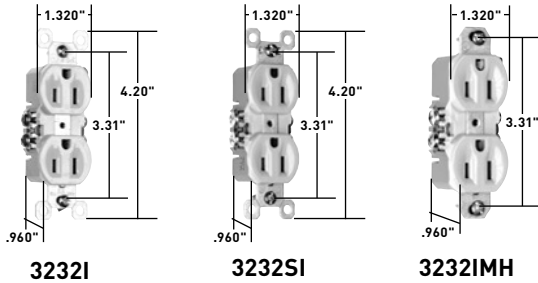

Features

- High-impact resistant thermoplastic construction.
- Extra-long strap.
- Quickloop wire looping aid.
- Long-term blade retention.
- Longer tri-drive screws for easier #12 AWG looping.
- Extra-large circuit break-off tabs.
- Side-access push wire release.
- Ultrasonic welding of face to back body.
- Side wire accepts #12 – #14 AWG solid wire.
- Push wire accepts #14 AWG solid only.
- Low profile face.
- Traditional contoured face (3232 models).
- Self-grounding models provide automatic ground clip.

CATALOG NUMBER	RATING		COLOR	NEMA CONFIG. NO.	3rd PARTY COMPLIANCE		
	A.	V.			UL498	C22.2 No. 42	cULus
DUPLEX RECEPTACLES – GROUNDING							
3232I*	15	125	Ivory	5-15R	•	•	
3232W*	15	125	White	5-15R	•	•	
3232*	15	125	Brown	5-15R	•	•	
3232BK	15	125	Black	5-15R	•	•	
3232LA*	15	125	Light Almond	5-15R	•	•	
SELF-GROUNDING DUPLEX RECEPTACLES							
3232SI	15	125	Ivory	5-15R	•	•	
3232SW	15	125	White	5-15R	•	•	
3232S	15	125	Brown	5-15R	•	•	
3232SLA	15	125	Light Almond	5-15R	•	•	
4 TERMINAL, SCREWS IN							
3232I4	15	125	Ivory	5-15R	•	•	
3232W4	15	125	White	5-15R	•	•	
32324	15	125	Brown	5-15R	•	•	
DUPLEX RECEPTACLES – WITHOUT EARS							
3232IMH	15	125	Ivory	5-15R	•	•	
3232WMH	15	125	White	5-15R	•	•	
3232MH	15	125	Brown	5-15R	•	•	

2 Pole, 3 Wire

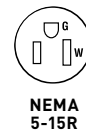

*Available in bulk packs of 150. Add "U" to end of Catalog Number. Example: 3232LAU.

STRAIGHT BLADE RECEPTACLES

radiant® Night Lights, Hallway Lights & Combination Devices

the radiant®
collection

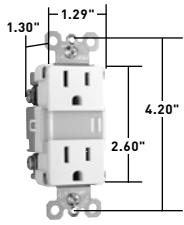

NTL885TRW

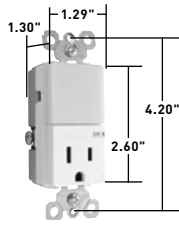

NTL81TRWCC6

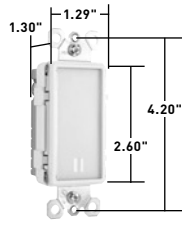

NTLFULLWCC6

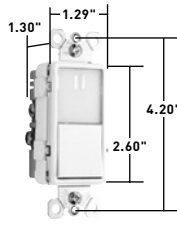

NTL873WCC6

The radiant® collection is a step up from the standard with simple, classic options in wiring devices, home automation controls, and screwless wall plates that complement today's homes and hospitality settings.

Features

- Part of the radiant® collection.
- 5 adjustable light settings including OFF
- Two tamper-resistant outlets — an industry exclusive
- Hidden sensor automatically controls night light
- Replaces any standard receptacle
- Optional louver included for additional light-level options
- Ideal for hallways, kitchens and nurseries
- Optional louver included with the Duplex Night Light Receptacle and the Full Night Light, for added light-level control.

CATALOG NUMBER	RATING		COLOR	NEMA CONFIG. NO.	3rd PARTY COMPLIANCE
	A.	VAC			cULus
NIGHT LIGHT WITH TWO 15A TAMPER-RESISTANT RECEPTACLES AND ADJUSTABLE LIGHT LEVELS with optional louver included					
NTL885TRICC6	15A	120/125V	Ivory	5-15R	•
NTL885TRW	15A	120/125V	White	5-15R	•
NTL885TRLACC6	15A	120/125V	Light Almond	5-15R	•
NTL885TRBKCC6	15A	120/125V	Black	5-15R	•
NTL885TRNICC6	15A	120/125V	Nickel	5-15R	•
NIGHT LIGHT WITH SINGLE TAMPER-RESISTANT RECEPTACLE					
NTL81TRICC6	15A	120/125V	Ivory	5-15R	•
NTL81TRWCC6	15A	120/125V	White	5-15R	•
NTL81TRLACC6	15A	120/125V	Light Almond	5-15R	•
NTL81TRBKCC6	15A	120/125V	Black	5-15R	•
FULL NIGHT LIGHT, ADJUSTABLE LIGHT LEVELS, TRI-COLOR with optional louver included					
NTLFULLTC		120/125V	Ivory/Light Almond/Black		•
FULL NIGHT LIGHT, ADJUSTABLE LIGHT LEVELS with optional louver included					
NTLFULLW		120/125V	White		•
AMBER LED NIGHT LIGHT WITH TWO 15A TAMPER-RESISTANT OUTLETS with louver included					
NTL885TRAMBERWCC6	15A	120/125V	White	5-15R	•
AMBER LED FULL NIGHT LIGHT with louver included					
NTLFULLAMBERWCC6		120/125V	White		•
AMBER LED NIGHT LIGHT WITH SINGLE POLE /3-WAY SWITCH					
NTL873AMBERWCC6	15A	120/125V	White		•

2 Pole, 3 Wire



NEMA 5-15R

GFCIs

the radiant[®] collection

radiant[®] Tamper-Resistant Self-Test GFCI Receptacles with SafeLock[®] Protection 2 Pole, 3 Wire Grounding 15 & 20A, 125VAC

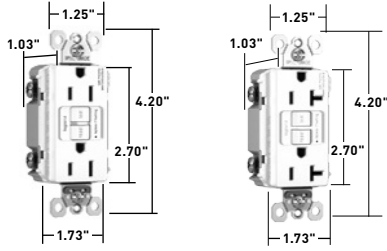

1597TRW

2097TRW

The radiant[®] collection is a step up from the standard with simple, classic options in wiring devices, home automation controls, and screwless wall plates that complement today's homes and hospitality settings.

Features

- Part of the radiant[®] collection of wiring devices, wall plates and home systems.
- Protects children: patented shutter system helps prevent improper insertion of foreign objects.
- Meets National Electrical Code[®] Tamper-Resistant requirements.
- Conducts an automatic test every three seconds, ensuring it's always ready to protect. If the device fails the test, the indicator light flashes to signal that the GFCI should be replaced. It also has our proven SafeLock Protection feature: if critical components are damaged and protection is lost, power to the receptacle is disconnected.
- Thinner than competitors' GFCI Receptacles: leaves more room for wires in the box.
- Auto-Ground clip assures a positive ground to metal box.
- Feed-thru wiring configuration allows GFCI to protect downstream receptacles.
- Prevents line-load reversal miswire: no power to the face or downstream receptacles if wired incorrectly.
- Exceeds UL943 voltage surge requirements.
- FSUL Listed (Federal Specification WC596).
- Trip indicator light (red LED).
- Side or internal screw-pressure-plate back wire with #10 – #14 AWG solid or stranded copper wire.
- Two back wire holes per terminal.
- Ground screw has a back wire clamp for easy installation.
- 10kA short circuit rating.
- Mounting screws are shipped captive in the device and wall plate for easier installation.
- High-impact-resistant thermoplastic construction.
- Extra-long strap.
- Button colors match the device face.
- Dual-direction test and reset buttons.
- Supplied with matching TP26 nylon wall plate (except NI and DB models).
- Tri-drive screws.

Specifications

- Supply Voltage: 125VAC, 60 Hz
- Supply Voltage Range: 102-132 VAC
- Trio Threshold: 5± 1mA
- Trip Time: 0.025 sec., nominal per UL Standard
- 20 Amp feed-thru capacity

CATALOG NUMBER	RATING		COLOR	NEMA CONFIG. NO.	3rd PARTY COMPLIANCE		
	A.	VAC			UL943 C22.2 No. 144	UL498 C22.2 No. 42	FSUL WC596
RADIANT[®] SPEC GRADE TAMPER-RESISTANT 15 AMP DUPLEX GFCI							
1597TRI	15	125	Ivory	5-15R	•	•	•
1597TRW	15	125	White	5-15R	•	•	•
1597TR	15	125	Brown	5-15R	•	•	•
1597TRBK	15	125	Black	5-15R	•	•	•
1597TRLA	15	125	Light Almond	5-15R	•	•	•
1597TRNICC4	15	125	Nickel	5-15R	•	•	•
1597TRDBCC4	15	125	Dark Bronze	5-15R	•	•	•
RADIANT[®] SPECIFICATION GRADE TAMPER-RESISTANT 20 AMP DUPLEX GFCI							
2097TRI	20	125	Ivory	5-20R	•	•	•
2097TRW	20	125	White	5-20R	•	•	•
2097TR	20	125	Brown	5-20R	•	•	•
2097TRGRY	20	125	Gray	5-20R	•	•	•
2097TRBK	20	125	Black	5-20R	•	•	•
2097TRRED	20	125	Red	5-20R	•	•	•
2097TRLA	20	125	Light Almond	5-20R	•	•	•

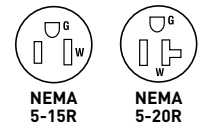

STRAIGHT BLADE RECEPTACLES

GFCIs

Hospital Grade Tamper-Resistant Self-Test GFCI Receptacles with SafeLock® Protection 2 Pole, 3 Wire Grounding 15 & 20A, 125VAC

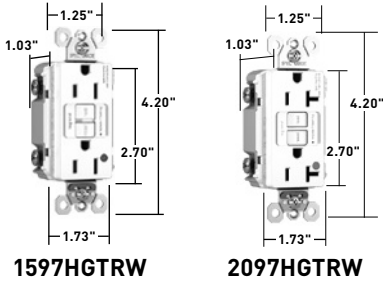

Features

- Protects children: patented shutter system helps prevent improper insertion of foreign objects.
- Meets National Electrical Code® Tamper-Resistant requirements.
- Conducts an automatic test every three seconds, ensuring it's always ready to protect. If the device fails the test, the indicator light flashes to signal that the GFCI should be replaced. It also has our proven SafeLock Protection feature: if critical components are damaged and protection is lost, power to the receptacle is disconnected.
- Thinner than competitors' GFCI Receptacles: leaves more room for wires in the box.
- Auto-Ground clip assures a positive ground to metal box.
- Feed-thru wiring configuration allows GFCI to protect downstream receptacles.
- Prevents line-load reversal miswire: no power to the face or downstream receptacles if wired incorrectly.
- Exceeds UL943 voltage surge requirements.
- FSUL Listed (Federal Specification WC596).
- Trip indicator light (red LED).
- Side or internal screw-pressure-plate back wire with #10 – #14 AWG solid or stranded copper wire.
- Two back wire holes per terminal.
- Ground screw has a back wire clamp for easy installation.
- 10kA short circuit rating.
- Mounting screws are shipped captive in the device and wall plate for easier installation.
- High-impact-resistant thermoplastic construction.
- Extra-long strap.
- Button colors match the device face.
- Dual-direction test and reset buttons.
- Class A rated GFCI.
- Supplied with matching TP26 nylon wall plate.
- Tri-drive screws.

Specifications

- Supply Voltage: 125VAC, 60 Hz
- Supply Voltage Range: 102-132 VAC
- Trio Threshold: 5± 1mA
- Trip Time: 0.025 sec., nominal per UL Standard
- 20 Amp feed-thru capacity

CATALOG NUMBER	RATING		COLOR	NEMA CONFIG. NO.	3rd PARTY COMPLIANCE		
	A.	VAC			UL943 C22.2 No. 144	UL498 C22.2 No. 42	FSUL WC596
HOSPITAL GRADE TAMPER-RESISTANT 15 AMP DUPLEX GFCI							
1597HGTRI	15	125	Ivory	5-15R	•	•	•
1597HGTRW	15	125	White	5-15R	•	•	•
1597HGTR	15	125	Brown	5-15R	•	•	•
1597HGTRBK	15	125	Black	5-15R	•	•	•
1597HGTRGRY	15	125	Gray	5-15R	•	•	•
1597HGTRRED	15	125	Red	5-15R	•	•	•
1597HGTRLA	15	125	Light Almond	5-15R	•	•	•
HOSPITAL GRADE TAMPER-RESISTANT 20 AMP DUPLEX GFCI							
2097HGTRI	20	125	Ivory	5-20R	•	•	•
2097HGTRW	20	125	White	5-20R	•	•	•
2097HGTR	20	125	Brown	5-20R	•	•	•
2097HGTRBK	20	125	Black	5-20R	•	•	•
2097HGTRGRY	20	125	Gray	5-20R	•	•	•
2097HGTRRED	20	125	Red	5-20R	•	•	•
2097HGTRLA	20	125	Light Almond	5-20R	•	•	•

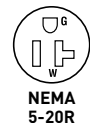
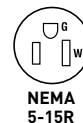

STRAIGHT BLADE RECEPTACLES

GFCIs

the radiant[®] collection

radiant[®] Specification Grade Self-Test GFCI Receptacles with SafeLock[®] Protection

2 Pole, 3 Wire Grounding 15 & 20A, 125VAC

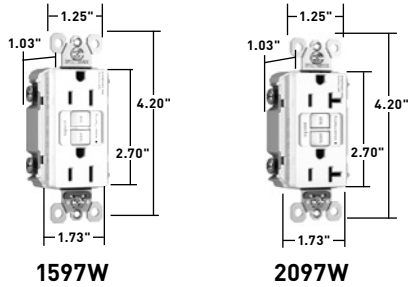

The radiant[®] collection is a step up from the standard with simple, classic options in wiring devices, home automation controls, and screwless wall plates that complement today's homes and hospitality settings.

Features

- Part of the radiant[®] collection of wiring devices, wall plates and home systems.
- Conducts an automatic test every three seconds, ensuring it's always ready to protect. If the device fails the test, the indicator light flashes to signal that the GFCI should be replaced. It also has our proven SafeLock Protection feature: if critical components are damaged and protection is lost, power to the receptacle is disconnected.
- Thinner than competitors' GFCI Receptacles: leaves more room for wires in the box.
- Auto-Ground clip assures a positive ground to metal box.
- Feed-thru wiring configuration allows GFCI to protect downstream receptacles.
- Prevents line-load reversal miswire: no power to the face or downstream receptacles if wired incorrectly.
- Exceeds UL943 voltage surge requirements.
- FSUL Listed (Federal Specification WC596).
- Trip indicator light (red LED).
- Side or internal screw-pressure-plate back wire with #10 – #14 AWG solid or stranded copper wire.
- Two back wire holes per terminal.
- Ground screw has a back wire clamp for easy installation.
- 10kA short circuit rating.
- Mounting screws are shipped captive in the device and wall plate for easier installation.
- High-impact-resistant thermoplastic construction.
- Extra-long strap.
- Button colors match the device face.
- Dual-direction test and reset buttons.
- Class A rated GFCI.
- Supplied with matching TP26 nylon wall plate.
- Tri-drive screws.

Specifications

- Supply Voltage: 125VAC, 60 Hz
- Supply Voltage Range: 102-132 VAC
- Trip Threshold: 5± 1mA
- Trip Time: 0.025 sec., nominal per UL Standard
- 20 Amp feed-thru capacity

CATALOG NUMBER	RATING		COLOR	NEMA CONFIG. NO.	3rd PARTY COMPLIANCE		
	A.	VAC			cUL ^{us} UL943 C22.2 No. 144	cUL ^{us} UL498 C22.2 No. 42	FSUL WC596
RADIANT[®] SPEC GRADE 15 AMP DUPLEX GFCI							
1597I	15	125	Ivory	5-15R	•	•	•
1597W	15	125	White	5-15R	•	•	•
1597	15	125	Brown	5-15R	•	•	•
1597GRY	15	125	Gray	5-15R	•	•	•
1597BK	15	125	Black	5-15R	•	•	•
1597RED	15	125	Red	5-15R	•	•	•
1597LA	15	125	Light Almond	5-15R	•	•	•
RADIANT[®] SPECIFICATION GRADE 20 AMP DUPLEX GFCI							
2097I	20	125	Ivory	5-20R	•	•	•
2097W	20	125	White	5-20R	•	•	•
2097	20	125	Brown	5-20R	•	•	•
2097GRY	20	125	Gray	5-20R	•	•	•
2097BK	20	125	Black	5-20R	•	•	•
2097RED	20	125	Red	5-20R	•	•	•
2097LA	20	125	Light Almond	5-20R	•	•	•

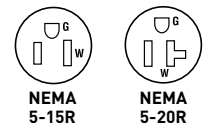

STRAIGHT BLADE RECEPTACLES

GFCIs

Hospital Grade Self-Test GFCI Receptacles with SafeLock® Protection 2 Pole, 3 Wire Grounding 15 & 20A, 125VAC

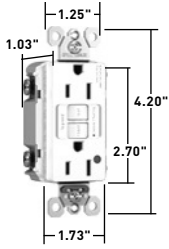

1597HGW

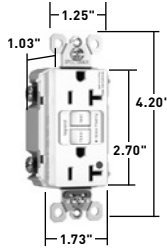

2097HGW

Features

- Conducts an automatic test every three seconds, ensuring it's always ready to protect. If the device fails the test, the indicator light flashes to signal that the GFCI should be replaced. It also has our proven SafeLock Protection feature: if critical components are damaged and protection is lost, power to the receptacle is disconnected.
- Thinner than competitors' GFCI Receptacles: leaves more room for wires in the box.
- Auto-Ground clip assures a positive ground to metal box.
- Feed-thru wiring configuration allows GFCI to protect downstream receptacles.
- Prevents line-load reversal miswire: no power to the face or downstream receptacles if wired incorrectly.
- Exceeds UL943 voltage surge requirements.
- FSUL Listed (Federal Specification WC596).
- Trip indicator light (red LED).
- Side or internal screw-pressure-plate back wire with #10 – #14 AWG solid or stranded copper wire.
- Two back wire holes per terminal.
- Ground screw has a back wire clamp for easy installation.
- 10kA short circuit rating.
- Mounting screws are shipped captive in the device and wall plate for easier installation.
- High-impact-resistant thermoplastic construction.
- Extra-long strap.
- Button colors match the device face.
- Dual-direction test and reset buttons.
- Class A rated GFCI.
- Supplied with matching TP26 nylon wall plate.
- Tri-drive screws.

Specifications

- Supply Voltage: 125VAC, 60 Hz
- Supply Voltage Range: 102-132 VAC
- Trip Threshold: 5± 1mA
- Trip Time: 0.025 sec., nominal per UL Standard
- 20 Amp feed-thru capacity

CATALOG NUMBER	RATING		COLOR	NEMA CONFIG. NO.	3rd PARTY COMPLIANCE		
	A.	VAC			UL943 C22.2 No. 144	UL498 C22.2 No. 42	FSUL WC596
HOSPITAL GRADE 15 AMP DUPLEX GFCI							
1597HGI	15	125	Ivory	5-15R	•	•	•
1597HGW	15	125	White	5-15R	•	•	•
1597HGBK	15	125	Black	5-15R	•	•	•
1597HGGRY	15	125	Gray	5-15R	•	•	•
1597HGRED	15	125	Red	5-15R	•	•	•
1597HGLA	15	125	Light Almond	5-15R	•	•	•
HOSPITAL GRADE 20 AMP DUPLEX GFCI							
2097HGI	20	125	Ivory	5-20R	•	•	•
2097HGW	20	125	White	5-20R	•	•	•
2097HG	20	125	Brown	5-20R	•	•	•
2097HGBK	20	125	Black	5-20R	•	•	•
2097HGGRY	20	125	Gray	5-20R	•	•	•
2097HGRED	20	125	Red	5-20R	•	•	•
2097HGLA	20	125	Light Almond	5-20R	•	•	•

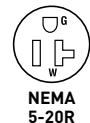
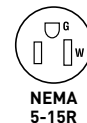

STRAIGHT BLADE RECEPTACLES

GFCIs

the radiant[®]
collection

radiant[®] Tamper-Resistant Self-Test Switch /GFCI Receptacles with SafeLock[®] Protection 15A, 125VAC

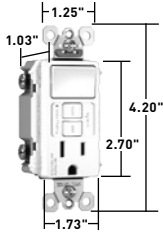

1597SWTTRWCC4

The radiant[®] collection is a step up from the standard with simple, classic options in wiring devices, home automation controls, and screwless wall plates that complement today's homes and hospitality settings.

Features

- Part of the radiant[®] collection of wiring devices, wall plates and home systems.
- Protects children: patented shutter system helps prevent improper insertion of foreign objects.
- Meets National Electrical Code[®] Tamper-Resistant requirements.
- Conducts an automatic test every three seconds, ensuring it's always ready to protect. If the device fails the test, the indicator light flashes to signal that the GFCI should be replaced. It also has our proven SafeLock Protection feature: if critical components are damaged and protection is lost, power to the receptacle is disconnected.
- Thinner than competitors' GFCI Receptacles: leaves more room for wires in the box.
- Auto-Ground clip assures a positive ground to metal box.
- Feed-thru wiring configuration allows GFCI to protect downstream receptacles.
- Prevents line-load reversal miswire: no power to the face or downstream receptacles if wired incorrectly.
- Exceeds UL943 voltage surge requirements.
- Trip indicator light (red LED).
- Two back wire holes per terminal.
- Side or internal screw-pressure-plate back wire with #10 - #14 AWG solid or stranded copper wire.
- Ground screw has a back wire clamp for easy installation.
- 10kA short circuit rating.
- Mounting screws are shipped captive in the device and wall plate for easier installation.
- High-impact-resistant thermoplastic construction.
- Extra-long strap.
- Button colors match the device face.
- Dual-direction test and reset buttons.
- Class A rated GFCI.
- Supplied with matching TP26 nylon wall plate.
- Tri-drive screws.

Specifications

- Supply Voltage: 125VAC, 60 Hz
- Supply Voltage Range: 102-132 VAC
- Trip Threshold: 5± 1mA
- Trip Time: 0.025 sec., nominal per UL Standard
- 20 Amp feed-thru capacity

CATALOG NUMBER	SWITCH RATING		RECEPTACLE RATING		COLOR	NEMA CONFIG. NO.	3rd PARTY COMPLIANCE		
	A.	VAC	A.	VAC			UL943 C22.2 No. 144	UL498 C22.2 No. 42	UL943 C22.2 No. 144
RADIANT[®] COMBINATION TAMPER-RESISTANT SINGLE POLE SWITCH/GFCI									
1597SWTTRICC4	15	120	15	125	Ivory	5-15R	•	•	•
1597SWTTRWCC4	15	120	15	125	White	5-15R	•	•	•
1597SWTTRBKCC4	15	120	15	125	Black	5-15R	•	•	•
1597SWTTRLACC4	15	120	15	125	Light Almond	5-15R	•	•	•

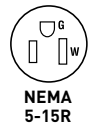

STRAIGHT BLADE RECEPTACLES

GFCIs

radiant® and Hospital Grade Tamper-Resistant Self-Test Night Light/GFCI Receptacles with SafeLock® Protection 2 Pole, 3 Wire Grounding 15 & 20A, 125VAC

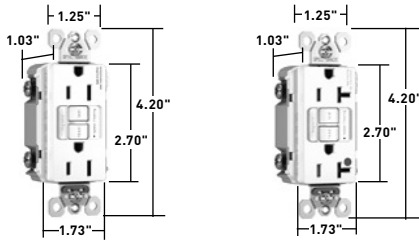

1597NTLRWCC4

2097HGNTLTRW

The radiant® collection is a step up from the standard with simple, classic options in wiring devices, home automation controls, and screwless wall plates that complement today's homes and hospitality settings.

Features

- Part of the radiant® collection of wiring devices, wall plates and home systems.
- Protects children: patented shutter system helps prevent improper insertion of foreign objects.
- Meets National Electrical Code® Tamper-Resistant requirements.
- Conducts an automatic test every three seconds, ensuring it's always ready to protect. If the device fails the test, the indicator light flashes to signal that the GFCI should be replaced. It also has our proven SafeLock Protection feature: if critical components are damaged and protection is lost, power to the receptacle is disconnected.
- Thinner than competitors' GFCI Receptacles: leaves more room for wires in the box.
- Auto-Ground clip assures a positive ground to metal box.
- Sealed night light with high impact-resistant Lexan® lens prevents tampering.
- Night light uses cooler LED illumination.
- Energy-efficient LED has average 20-year life expectancy, eliminating bulb replacement.
- LED Rated at 186 milliwatts @ 120V.
- Photocell turns night light ON in dark, OFF in daylight.
- Two receptacles.
- Feed-thru wiring configuration allows GFCI to protect downstream receptacles.
- Prevents line-load reversal miswire: no power to the face or downstream receptacles if wired incorrectly.
- Exceeds UL943 voltage surge requirements.
- FSUL Listed (Federal Specification WC596).
- Trip indicator light (red LED).
- Side or internal screw-pressure-plate back wire with #10 – #14 AWG solid or stranded copper wire.
- Two back wire holes per terminal.
- Ground screw has a back wire clamp for easy installation.
- 10kA short circuit rating.
- Mounting screws are shipped captive in the device and wall plate for easier installation.
- High-impact-resistant thermoplastic construction.
- Extra-long strap.
- Button colors match the device face.
- Dual-direction test and reset buttons.
- Class A rated GFCI.
- Supplied with matching TP26 nylon wall plate (except 1597NTLTRNICC4 and 1597NTLTRDBCC4).

Specifications

- Supply Voltage: 125VAC, 60 Hz
- Supply Voltage Range: 102-132 VAC
- Trio Threshold: 5± 1mA
- Trip Time: 0.025 sec., nominal per UL Standard
- 20 Amp feed-thru capacity

CATALOG NUMBER	RATING		LIGHT OUTPUT IN 1' FCD*	COLOR	NEMA CONFIG. NO.	3rd PARTY COMPLIANCE		
	A.	VAC				UL943 C22.2 No. 144	UL498 C22.2 No. 42	FSUL WC596
RADIANT® COMBINATION TAMPER-RESISTANT 15 AMP NIGHT LIGHT/GFCI								
1597NTLTRI	15	125	0.10	Ivory	5-15R	•	•	•
1597NTLTRW	15	125	0.10	White	5-15R	•	•	•
1597NTLTRBKCC4	15	125	0.10	Black	5-15R	•	•	•
1597NTLTRLA	15	125	0.10	Light Almond	5-15R	•	•	•
1597NTLTRNICC4	15	125	0.10	Nickel	5-15R	•	•	•
1597NTLTRDBCC4	15	125	0.10	Dark Bronze	5-15R	•	•	•
RADIANT® COMBINATION TAMPER-RESISTANT 20 AMP NIGHT LIGHT/GFCI								
2097NTLTRI	20	125	0.10	Ivory	5-20R	•	•	•
2097NTLTRW	20	125	0.10	White	5-20R	•	•	•
2097NTLTRGRY	20	125	0.10	Gray	5-20R	•	•	•
2097NTLTRLA	20	125	0.10	Light Almond	5-20R	•	•	•
HOSPITAL GRADE COMBINATION TAMPER-RESISTANT 20 AMP NIGHT LIGHT/GFCI								
2097HGNTLTRI	20	125	0.10	Ivory	5-20R	•	•	•
2097HGNTLTRW	20	125	0.10	White	5-20R	•	•	•
2097HGNTLTRGRY	20	125	0.10	Gray	5-20R	•	•	•
2097HGNTLTRRED	20	125	0.10	Red	5-20R	•	•	•
2097HGNTLTRLA	20	125	0.10	Light Almond	5-20R	•	•	•

*FCD = Foot Candle Distance, 1 Lumen = 1 FCD. See Page U-68 for more information.

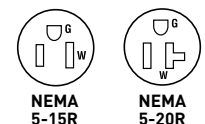

STRAIGHT BLADE RECEPTACLES

GFCIs

the radiant[®] collection

radiant[®] Weather-Resistant Self-Test GFCI Receptacles with SafeLock[®] Protection 2 Pole, 3 Wire Grounding 15 & 20A, 125VAC

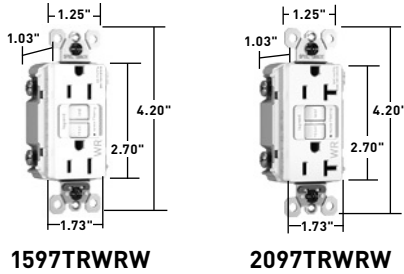

The radiant[®] collection is a step up from the standard with simple, classic options in wiring devices, home automation controls, and screwless wall plates that complement today's homes and hospitality settings.

Features

- Part of the radiant[®] collection of wiring devices, wall plates and home systems.
- Weather-Resistant: Meets National Electrical Code[®] Weather-Resistant requirements.
- Tamper-Resistant: Meets National Electrical Code[®] Tamper-Resistant requirements.
- Protects children: patented shutter system helps prevent improper insertion of foreign objects.
- Listed to the Weather-Resistant supplement of UL498 meeting demanding UL requirements including:
 - Ultraviolet light exposure test
 - Cold impact test
 - Accelerated aging test
 - Stringent material requirements for current carrying parts, wire binding screws and mounting straps to ensure superior corrosion resistance.
- Conducts an automatic test every three seconds, ensuring it's always ready to protect. If the device fails the test, the indicator light flashes to signal that the GFCI should be replaced. It also has our proven SafeLock Protection feature: if critical components are damaged and protection is lost, power to the receptacle is disconnected.
- Thinner than competitors' GFCI Receptacles: leaves more room for wires in the box.
- Auto-Ground clip assures a positive ground to metal box.
- Feed-thru wiring configuration allows GFCI to protect downstream receptacles.
- Prevents line-load reversal miswire: no power to the face or downstream receptacles if wired incorrectly.
- Exceeds UL943 voltage surge requirements.
- FSUL Listed (Federal Specification WC596).
- Trip indicator light (red LED)
- Side or internal screw-pressure-plate back wire with #10 - #14 AWG solid or stranded copper wire.
- Two back wire holes per terminal.
- Ground screw has a back wire clamp for easy installation.
- 10kA short circuit rating.
- Mounting screws are shipped captive in the device and wall plate for easier installation.
- High-impact-resistant thermoplastic construction.
- Extra-long nickel post-plated steel mounting strap.
- Button colors match the device face.
- Dual-direction test and reset buttons.
- Class A rated GFCI.
- Supplied with matching TP26 nylon wall plate.
- Tri-drive screws.

Specifications

- Supply Voltage: 125VAC, 60 Hz
- Supply Voltage Range: 102-132 VAC
- Trio Threshold: 5± 1mA
- Trip Time: 0.025 sec., nominal per UL Standard
- 20 Amp feed-thru capacity

CATALOG NUMBER	RATING		COLOR	NEMA CONFIG. NO.	3rd PARTY COMPLIANCE		
	A.	VAC			UL943 C22.2 No. 144	UL498 C22.2 No. 42	FSUL WC596
RADIANT[®] SPEC GRADE WEATHER-RESISTANT 15 AMP DUPLEX GFCI							
1597TRWRI	15	125	Ivory	5-15R	•	•	•
1597TRWRW	15	125	White	5-15R	•	•	•
1597TRWR	15	125	Brown	5-15R	•	•	•
1597TRWRGRY	15	125	Gray	5-15R	•	•	•
1597TRWRBK	15	125	Black	5-15R	•	•	•
1597TRWRLA	15	125	Light Almond	5-15R	•	•	•
RADIANT[®] SPECIFICATION GRADE WEATHER-RESISTANT 20 AMP DUPLEX GFCI							
2097TRWRI	20	125	Ivory	5-20R	•	•	•
2097TRWRW	20	125	White	5-20R	•	•	•
2097TRWR	20	125	Brown	5-20R	•	•	•
2097TRWRGRY	20	125	Gray	5-20R	•	•	•
2097TRWRBK	20	125	Black	5-20R	•	•	•
2097TRWRLA	20	125	Light Almond	5-20R	•	•	•

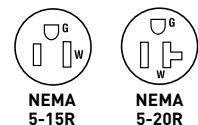

STRAIGHT BLADE RECEPTACLES

GFCIs

PlugTail® Self-Test GFCI Receptacles with SafeLock® Protection 2 Pole, 3 Wire Grounding 15 & 20A, 125VAC

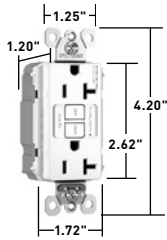

PT2097W

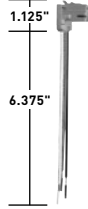

PTRA6STR

Features

- Faster, more reliable installation.
- No exposed terminals create a finger safe application before, during, and after installation.
- Built-in connector features large brass terminal blades to ensure consistent, reliable electrical connections to PlugTail Connector.
- GFCI works with the existing 3-wire PlugTail Connectors creating a non-feed-thru application for facility owners.
- Conducts an automatic test every three seconds, ensuring it's always ready to protect. If the device fails the test, the indicator light flashes to signal that the GFCI should be replaced. It also has our proven SafeLock Protection feature: if critical components are damaged and protection is lost, power to the receptacle is disconnected.
- Thinner than competitors' GFCI Receptacles: leaves more room for wires in the box.
- Auto-Ground clip assures a positive ground to metal box.
- FSUL Listed (Federal Specification WC596).
- Exceeds UL 943 voltage surge requirements.
- Trip indicator light (red LED).
- 10kA short circuit rating.
- Mounting screws are shipped captive in the device and wall plate for easier installation.
- High-impact-resistant thermoplastic construction.
- Zinc-plated steel mounting strap.
- Button colors match the device face.
- Dual-direction test and reset buttons.
- Class A rated GFCI.
- Supplied with matching TP26 nylon wall plate.
- Tri-drive screws.

Specifications

- Supply Voltage: 125VAC, 60 Hz
- Supply Voltage Range: 102-132 VAC
- Trip Threshold: 5± 1mA
- Trip Time: 0.025 sec., nominal per UL Standard

CATALOG NUMBER	RATING		COLOR	NEMA CONFIG. NO.	3rd PARTY COMPLIANCE		
	A.	VAC			UL943 C22.2 No. 144	UL498 C22.2 No. 42	FSUL WC596
SPECIFICATION GRADE 15 AMP DUPLEX GFCI							
PT1597I	15	125	Ivory	5-15R	•	•	•
PT1597W	15	125	White	5-15R	•	•	•
PT1597GRY	15	125	Gray	5-15R	•	•	•
PT1597LA	15	125	Light Almond	5-15R	•	•	•
SPECIFICATION GRADE 20 AMP DUPLEX GFCI							
PT2097I	20	125	Ivory	5-20R	•	•	•
PT2097W	20	125	White	5-20R	•	•	•
PT2097	20	125	Brown	5-20R	•	•	•
PT2097GRY	20	125	Gray	5-20R	•	•	•
PT2097BKB	20	125	Black	5-20R	•	•	•
PT2097RED	20	125	Red	5-20R	•	•	•
PT2097LA	20	125	Light Almond	5-20R	•	•	•

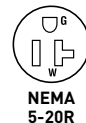
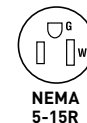

CATALOG NUMBER	WIRE TYPE	WIRE LENGTH
PLUGTAIL CONNECTORS - RIGHT ANGLE		
PTRA6STR	Stranded	6"
PTRA6SOL	Solid	6"

For additional PlugTail Connectors, see Page B-4.

All PlugTail Connectors are available in any wire length up to 25 inches, consult factory to order.

STRAIGHT BLADE RECEPTACLES

GFCIs

PlugTail® Hospital Grade Self-Test GFCI Receptacles with SafeLock® Protection 2 Pole, 3 Wire Grounding 15 & 20A, 125VAC

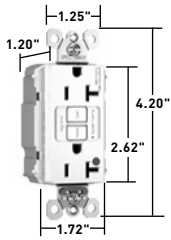

PT2097HGW

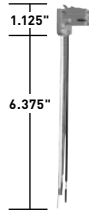

PTR6STR

Features

- Faster, more reliable installation.
- No exposed terminals create a finger safe application before, during, and after installation.
- Built-in connector features large brass terminal blades to ensure consistent, reliable electrical connections to PlugTail Connector.
- GFCI works with the existing 3-wire PlugTail Connectors creating a non-feed-thru application for facility owners.
- Conducts an automatic test every three seconds, ensuring it's always ready to protect. If the device fails the test, the indicator light flashes to signal that the GFCI should be replaced. It also has our proven SafeLock Protection feature: if critical components are damaged and protection is lost, power to the receptacle is disconnected.
- Thinner than competitors' GFCI Receptacles: leaves more room for wires in the box.
- Auto-Ground clip assures a positive ground to metal box.
- 10kA short circuit rating.
- FSUL Listed (Federal Specification WC596).
- Exceeds UL 943 voltage surge requirements.
- Trip indicator light (red LED).
- Mounting screws are shipped captive in the device and wall plate for easier installation.
- High-impact-resistant thermoplastic construction.
- Zinc-plated steel mounting strap.
- Button colors match the device face.
- Dual-direction test and reset buttons.
- Class A rated GFCI.
- Supplied with matching TP26 nylon wall plate.
- Tri-drive screws.

Specifications

- Supply Voltage: 125VAC, 60 Hz
- Supply Voltage Range: 102-132 VAC
- Trio Threshold: 5± 1mA
- Trip Time: 0.025 sec., nominal per UL Standard

CATALOG NUMBER	RATING		COLOR	NEMA CONFIG. NO.	3rd PARTY COMPLIANCE		
	A.	VAC			UL943 C22.2 No. 144	UL498 C22.2 No. 42	FSUL WC596
HOSPITAL GRADE 15 AMP DUPLEX GFCI							
PT1597HGW	15	125	White	5-15R	•	•	•
PT1597HGRED	15	125	Red	5-15R	•	•	•
PT1597HGLA	15	125	Light Almond	5-15R	•	•	•
HOSPITAL GRADE 20 AMP DUPLEX GFCI							
PT2097HGI	20	125	Ivory	5-20R	•	•	•
PT2097HGW	20	125	White	5-20R	•	•	•
PT2097HG	20	125	Brown	5-20R	•	•	•
PT2097HGGRY	20	125	Gray	5-20R	•	•	•
PT2097HGBK	20	125	Black	5-20R	•	•	•
PT2097HGRED	20	125	Red	5-20R	•	•	•
PT2097HGLA	20	125	Light Almond	5-20R	•	•	•

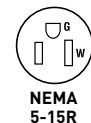

CATALOG NUMBER	WIRE TYPE	WIRE LENGTH
PLUGTAIL CONNECTORS – RIGHT ANGLE		
PTR6STR	Stranded	6"
PTR6SOL	Solid	6"

For additional PlugTail Connectors, see Page B-4.

All PlugTail Connectors are available in any wire length up to 25 inches, consult factory to order.

All devices listed on this page conform to NEMA WD-1 and WD-6.

GFCIs

PlugTail® Specification & Hospital Grade Tamper-Resistant Self-Test GFCI Receptacles with SafeLock® Protection 2 Pole, 3 Wire Grounding 15 & 20A, 125VAC

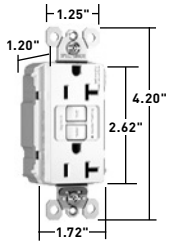

PT2097TRW

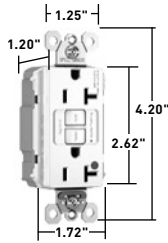

PT2097HGTRW

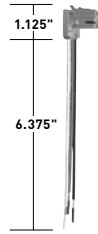

PTR6A6STR

Features

- Protects children: patented shutter system helps prevent improper insertion of foreign objects.
- Meets National Electrical Code® Tamper-Resistant requirements.
- Faster, more reliable installation.
- No exposed terminals create a finger safe application before, during, and after installation.
- Built-in connector features large brass terminal blades to ensure consistent, reliable electrical connections to PlugTail Connector.
- GFCI works with the existing 3-wire PlugTail Connectors creating a non-feed-thru application for facility owners.
- Conducts an automatic test every three seconds, ensuring it's always ready to protect. If the device fails the test, the indicator light flashes to signal that the GFCI should be replaced. It also has our proven SafeLock Protection feature: if critical components are damaged and protection is lost, power to the receptacle is disconnected.
- Thinner than competitors' GFCI Receptacles: leaves more room for wires in the box.
- Auto-Ground clip assures a positive ground to metal box.
- 10kA short circuit rating.
- FSUL Listed (Federal Specification WC596).
- Exceed UL 943 voltage surge requirements.
- Trip indicator light (red LED).
- Mounting screws are shipped captive in the device and wall plate for easier installation.
- High-impact-resistant thermoplastic construction.
- Zinc-plated steel mounting strap.
- Button colors match the device face.
- Dual-direction test and reset buttons.
- Class A rated GFCI.
- Supplied with matching TP26 nylon wall plate.
- Tri-drive screws.

CATALOG NUMBER	RATING		COLOR	NEMA CONFIG. NO.	3rd PARTY COMPLIANCE		
	A.	VAC			UL943 C22.2 No. 144	UL498 C22.2 No. 42	FSUL WC596
SPECIFICATION GRADE TAMPER-RESISTANT 15 AMP DUPLEX GFCI							
PT1597TRI	15	125	Ivory	5-15R	•	•	•
PT1597TRW	15	125	White	5-15R	•	•	•
PT1597TRGRY	15	125	Gray	5-15R	•	•	•
PT1597TRRED	15	125	Red	5-15R	•	•	•
PT1597TRLA	15	125	Light Almond	5-15R	•	•	•
SPECIFICATION GRADE TAMPER-RESISTANT 20 AMP DUPLEX GFCI							
PT2097TRI	20	125	Ivory	5-20R	•	•	•
PT2097TRW	20	125	White	5-20R	•	•	•
PT2097TR	20	125	Brown	5-20R	•	•	•
PT2097TRGRY	20	125	Gray	5-20R	•	•	•
PT2097TRRED	20	125	Red	5-20R	•	•	•
PT2097TRLA	20	125	Light Almond	5-20R	•	•	•
HOSPITAL GRADE TAMPER-RESISTANT 15 AMP DUPLEX GFCI							
PT1597HGTRI	15	125	Ivory	5-15R	•	•	•
PT1597HGTRW	15	125	White	5-15R	•	•	•
PT1597HGTRRED	15	125	Red	5-15R	•	•	•
PT1597HGTRLA	15	125	Light Almond	5-15R	•	•	•
HOSPITAL GRADE TAMPER-RESISTANT 20 AMP DUPLEX GFCI							
PT2097HGTRI	20	125	Ivory	5-20R	•	•	•
PT2097HGTRW	20	125	White	5-20R	•	•	•
PT2097HGTRGRY	20	125	Gray	5-20R	•	•	•
PT2097HGTRGBK	20	125	Black	5-20R	•	•	•
PT2097HGTRRED	20	125	Red	5-20R	•	•	•
PT2097HGTRLA	20	125	Light Almond	5-20R	•	•	•



NEMA 5-15R



NEMA 5-20R

For PlugTail Connector catalog numbers, see Page B-4.

STRAIGHT BLADE RECEPTACLES

GFCIs

PlugTail® Specification & Hospital Grade Tamper-Resistant Self-Test Night Light/ GFCI Receptacles with SafeLock® Protection 2 Pole, 3 Wire Grounding 15 & 20A, 125VAC

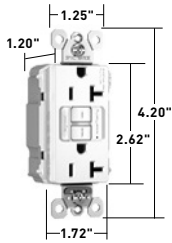

PT2097NTLTRW

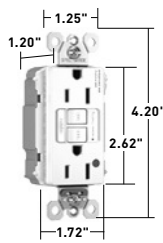

PT1597HGNTLTRI

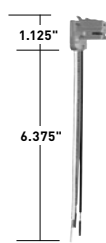

PTR465TR

Features

- Protects children: patented shutter system helps prevent improper insertion of foreign objects.
- Meets National Electrical Code® Tamper-Resistant requirements.
- Sealed night light with high impact-resistant Lexan® lens prevents tampering.
- Night light uses cooler LED illumination.
- Energy-efficient LED has average 20-year life expectancy, eliminating bulb replacement.
- Photocell turns night light ON in dark, OFF in daylight.
- Faster, more reliable installation.
- No exposed terminals create a finger safe application before, during, and after installation.
- Built-in connector features large brass terminal blades to ensure consistent, reliable electrical connections to PlugTail Connector.
- GFCI works with the existing 3-wire PlugTail Connectors creating a non-feed-thru application for facility owners. At rough-in just install the same right angle connector for GFCI and receptacle openings.
- Conducts an automatic test every three seconds, ensuring it's always ready to protect. If the device fails the test, the indicator light flashes to signal that the GFCI should be replaced. It also has our proven SafeLock Protection feature: if critical components are damaged and protection is lost, power to the receptacle is disconnected.
- Thinner than competitors' GFCI Receptacles: leaves more room for wires in the box.
- Auto-Ground clip assures a positive ground to metal box.
- Exceeds UL943 voltage surge requirements.
- 10kA short circuit rating.
- FSUL Listed (Federal Specification WC596).
- Trip indicator light (red LED).
- Mounting screws are shipped captive in the device and wall plate for easier installation.
- High-impact-resistant thermoplastic construction.
- Zinc-plated steel mounting strap.
- Button colors match the device face.
- Dual-direction test and reset buttons.
- Class A rated GFCI.
- Supplied with matching TP26 nylon wall plate.
- Tri-drive screws.

Specifications

- Supply Voltage: 125VAC, 60 Hz
- Supply Voltage Range: 102-132 VAC
- Trio Threshold: 5± 1mA
- Trip Time: 0.025 sec., nominal per UL Standard

CATALOG NUMBER	RATING		LIGHT OUTPUT IN 1' FCD*	COLOR	NEMA CONFIG. NO.	3rd PARTY COMPLIANCE		
	A.	VAC				UL943 C22.2 No. 144	UL498 C22.2 No. 42	FSUL WC596
SPECIFICATION GRADE TAMPER-RESISTANT 20 AMP COMBINATION NIGHT LIGHT/GFCI								
PT2097NTLTRI	20	125	0.10	Ivory	5-20R	•	•	•
PT2097NTLTRW	20	125	0.10	White	5-20R	•	•	•
HOSPITAL GRADE TAMPER-RESISTANT 15 AMP COMBINATION NIGHT LIGHT/GFCI								
PT1597HGNTLTRI	15	125	0.10	Ivory	5-15R	•	•	•
PT1597HGNTLRRD	15	125	0.10	Red	5-15R	•	•	•
HOSPITAL GRADE TAMPER-RESISTANT 20 AMP COMBINATION NIGHT LIGHT/GFCI								
PT2097HGNTLTRI	20	125	0.10	Ivory	5-20R	•	•	•
PT2097HGNTLTRW	20	125	0.10	White	5-20R	•	•	•
PT2097HGNTLTRGRY	20	125	0.10	Gray	5-20R	•	•	•
PT2097HGNTLTRLA	20	125	0.10	Light Almond	5-20R	•	•	•

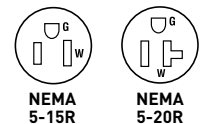

For PlugTail Connector catalog numbers, see Page B-4 .

STRAIGHT BLADE RECEPTACLES

GFCIs

radiant® NAFTA-Compliant Self-Test GFCI Receptacles with SafeLock® Protection 2 Pole, 3 Wire Grounding 15 & 20A, 125VAC

Features

- Part of the radiant® collection of wiring devices, wall plates and home systems.
- Conducts an automatic test every three seconds, ensuring it's always ready to protect. If the device fails the test, the indicator light flashes to signal that the GFCI should be replaced. It also has our proven SafeLock Protection feature: if critical components are damaged and protection is lost, power to the receptacle is disconnected.
- Thinner than competitors' GFCI Receptacles: leaves more room for wires in the box.
- Auto-Ground clip assures a positive ground to metal box.
- Feed-thru wiring configuration allows GFCI to protect downstream receptacles.
- Prevents line-load reversal miswire: no power to the face or downstream receptacles if wired incorrectly.
- Exceeds UL943 voltage surge requirements.
- FSUL Listed (Federal Specification WC596).
- Trip indicator light (red LED).
- Ground screw has a back wire clamp for easy installation.
- Side or internal screw-pressure-plate back wire with #10 – #14 AWG solid or stranded copper wire.
- Two back wire holes per terminal.
- 10kA short circuit rating.
- Class A rated GFCI.
- Supplied with matching TP26 nylon wall plate.
- Tri-drive screws.
- GFCIs with Auto-Ground assure a positive ground to metal box.
- WR models listed to the Weather-Resistant supplement of UL498, meet demanding UL requirements.

Specifications

- Supply Voltage: 125VAC, 60 Hz
- Supply Voltage Range: 102-132 VAC
- Trio Threshold: 5± 1mA
- Trip Time: 0.025 sec., nominal per UL Standard
- 20 Amp feed-thru capacity

CATALOG NUMBER	RATING		COLOR	NEMA CONFIG. NO.	3rd PARTY COMPLIANCE		
	A.	VAC			UL943 C22.2 No. 144	UL498 C22.2 No. 42	FSUL WC596
NAFTA-COMPLIANT RADIANT® SPEC GRADE TAMPER-RESISTANT 15 AMP DUPLEX GFCI							
1597TRNAI	15	125	Ivory	5-15R	•	•	•
1597TRNAW	15	125	White	5-15R	•	•	•
1597TRNAGRY	15	125	Gray	5-15R	•	•	•
1597TRNALA	15	125	Light Almond	5-15R	•	•	•
NAFTA-COMPLIANT RADIANT® SPEC GRADE TAMPER-RESISTANT 20 AMP DUPLEX GFCI							
2097TRNAI	20	125	Ivory	5-20R	•	•	•
2097TRNAW	20	125	White	5-20R	•	•	•
2097TRNAGRY	20	125	Gray	5-20R	•	•	•
2097TRNALA	20	125	Light Almond	5-20R	•	•	•
NAFTA-COMPLIANT RADIANT® SPEC GRADE 20 AMP DUPLEX GFCI							
2097NAI	20	125	Ivory	5-20R	•	•	•
2097NAW	20	125	White	5-20R	•	•	•
2097NA	20	125	Brown	5-20R	•	•	•
2097NAGRY	20	125	Gray	5-20R	•	•	•
2097NALA	20	125	Light Almond	5-20R	•	•	•
2097NABL	20	125	Blue	5-20R	•	•	•
NAFTA-COMPLIANT RADIANT® SPEC GRADE TAMPER-RESISTANT /WEATHER-RESISTANT 15 AMP DUPLEX GFCI							
1597TRWRNAI	15	125	Ivory	5-15R	•	•	•
1597TRWRNAW	15	125	White	5-15R	•	•	•
1597TRWRNA	15	125	Brown	5-15R	•	•	•
1597TRWRNALA	15	125	Light Almond	5-15R	•	•	•
NAFTA-COMPLIANT RADIANT® SPEC GRADE TAMPER-RESISTANT /WEATHER-RESISTANT 20 AMP DUPLEX GFCI							
2097TRWRNAI	20	125	Ivory	5-20R	•	•	•
2097TRWRNAW	20	125	White	5-20R	•	•	•
2097TRWRNAGRY	20	125	Gray	5-20R	•	•	•
2097TRWRNALA	20	125	Light Almond	5-20R	•	•	•

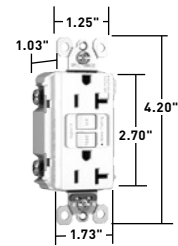

2097TRNAW

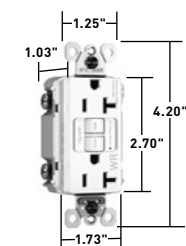

2097TRWRNAW

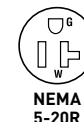
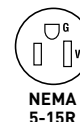

NAFTA-Compliant GFCI Receptacles are ideal for use on projects subject to the provisions of the Buy American Act.

STRAIGHT BLADE RECEPTACLES

GFCIs

NAFTA-Compliant Hospital Grade Self-Test GFCI Receptacles with SafeLock® Protection 2 Pole, 3 Wire Grounding 15 & 20A, 125VAC

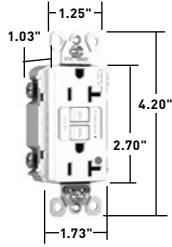

2097HGTRNAW

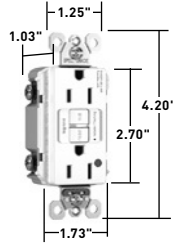

1597HGTRNAW

CATALOG NUMBER	RATING		COLOR	NEMA CONFIG. NO.	3rd PARTY COMPLIANCE		
	A.	VAC			UL943 C22.2 No. 144	UL498 C22.2 No. 42	FSUL WC596
NAFTA-COMPLIANT HOSPITAL GRADE TAMPER-RESISTANT 20 AMP DUPLEX GFCI							
2097HGTRNAI	20	125	Ivory	5-20R	•	•	•
2097HGTRNAW	20	125	White	5-20R	•	•	•
2097HGTRNARED	20	125	Red	5-20R	•	•	•
2097HGTRNALA	20	125	Light Almond	5-20R	•	•	•
NAFTA-COMPLIANT HOSPITAL GRADE 20 AMP DUPLEX GFCI							
2097HGNAI	20	125	Ivory	5-20R	•	•	•
2097HGNAW	20	125	White	5-20R	•	•	•
2097HGNAGRY	20	125	Gray	5-20R	•	•	•
2097HGNARED	20	125	Red	5-20R	•	•	•
2097HGNALA	20	125	Light Almond	5-20R	•	•	•

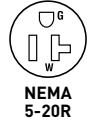
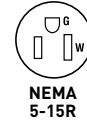

GFCIs

NAFTA-Compliant PlugTail® Self-Test GFCI Receptacles with SafeLock® Protection 2 Pole, 3 Wire Grounding 15 & 20A, 125VAC

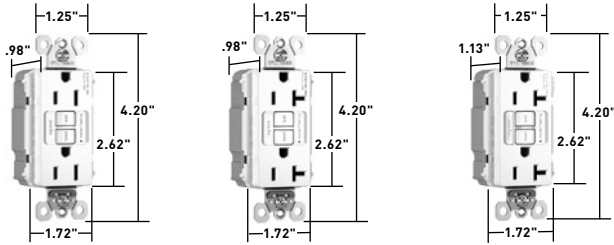

PT1597NAW

PT2097NAW

PT2097NTLTRNAW

Features

- Faster, more reliable installation.
- No exposed terminals create a finger safe application before, during, and after installation.
- Built-in connector features large brass terminal blades to ensure consistent, reliable electrical connections to PlugTail Connector.
- GFCI works with the existing 3-wire PlugTail Connectors creating a non-feed-thru application for facility owners. At rough-in just install the same right angle connector for GFCI and receptacle openings.
- Conducts an automatic test every three seconds, ensuring it's always ready to protect. If the device fails the test, the indicator light flashes to signal that the GFCI should be replaced. It also has our proven SafeLock Protection feature: if critical components are damaged and protection is lost, power to the receptacle is disconnected.
- Thinner than competitors' GFCI Receptacles: leaves more room for wires in the box.
- Auto-Ground clip assures a positive ground to metal box.
- FSUL Listed (Federal Specification WC596).
- Exceeds UL943 voltage surge requirements.
- Trip indicator light (red LED).
- Mounting screws are shipped captive in the device and wall plate for easier installation.
- High-impact-resistant thermoplastic construction.
- Zinc-plated steel mounting strap.
- Button colors match the device face.
- Dual-direction test and reset buttons.
- Class A rated GFCI.
- Supplied with matching TP26 nylon wall plate.
- Tri-drive screws.
- 10kA short circuit rating.

Specifications

- Supply Voltage: 125VAC, 60 Hz
- Supply Voltage Range: 102-132 VAC
- Trio Threshold: 5± 1mA
- Trip Time: 0.025 sec., nominal per UL Standard

CATALOG NUMBER	RATING		COLOR	NEMA CONFIG. NO.	3rd PARTY COMPLIANCE		
	A.	VAC			UL943 C22.2 No. 144	UL498 C22.2 No. 42	FSUL WC596
NAFTA-COMPLIANT SPEC GRADE 15 AMP DUPLEX GFCI							
PT1597NAW	15	125	White	5-15R	•	•	•
PT1597NAGRY	15	125	Gray	5-15R	•	•	•
PT1597NALA	15	125	Light Almond	5-15R	•	•	•
NAFTA-COMPLIANT SPEC GRADE 20 AMP DUPLEX GFCI							
PT2097NAW	20	125	White	5-20R	•	•	•
PT2097NABK	20	125	Black	5-20R	•	•	•
PT2097NALA	20	125	Light Almond	5-20R	•	•	•
NAFTA-COMPLIANT SPEC GRADE TAMPER-RESISTANT 20 AMP DUPLEX GFCI							
PT2097TRNAI	20	125	Ivory	5-20R	•	•	•
PT2097TRNAW	20	125	White	5-20R	•	•	•
PT2097TRNALA	20	125	Light Almond	5-20R	•	•	•
NAFTA-COMPLIANT SPEC GRADE TAMPER-RESISTANT 15 AMP COMBINATION NIGHT LIGHT/GFCI							
PT1597NTLTRNAW	15	125	White	5-15R	•	•	•
NAFTA-COMPLIANT SPEC GRADE TAMPER-RESISTANT 20 AMP COMBINATION NIGHT LIGHT/GFCI							
PT2097NTLTRNAI	20	125	Ivory	5-20R	•	•	•
PT2097NTLTRNAW	20	125	White	5-20R	•	•	•



NAFTA-Compliant GFCI Receptacles are ideal for use on projects subject to the provisions of the Buy American Act. For PlugTail Connector catalog numbers, see Page B-4.

GFCIS

NAFTA-Compliant PlugTail® Hospital Grade Self-Test GFCI Receptacles with SafeLock® Protection 2 Pole, 3 Wire Grounding 15 & 20A, 125VAC

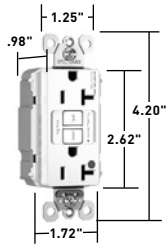

PT2097HGNAW

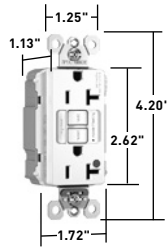

PT2097HGNTLTRW

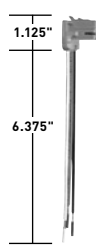

PTR6STR

Features

- Faster, more reliable installation.
- No exposed terminals create a finger safe application before, during, and after installation.
- Built-in connector features large brass terminal blades to ensure consistent, reliable electrical connections to PlugTail Connector.
- GFCI works with the existing 3-wire PlugTail Connectors creating a non-feed-thru application for facility owners. At rough-in just install the same right angle connector for GFCI and receptacle openings.
- Conducts an automatic test every three seconds, ensuring it's always ready to protect. If the device fails the test, the indicator light flashes to signal that the GFCI should be replaced. It also has our proven SafeLock Protection feature: if critical components are damaged and protection is lost, power to the receptacle is disconnected.
- Thinner than competitors' GFCI Receptacles: leaves more room for wires in the box.
- Auto-Ground clip assures a positive ground to metal box.
- FSUL Listed (Federal Specification WC596).
- Exceeds UL943 voltage surge requirements.
- Trip indicator light (red LED).
- Mounting screws are shipped captive in the device and wall plate for easier installation.
- High-impact-resistant thermoplastic construction.
- Zinc-plated steel mounting strap.
- Button colors match the device face.
- Dual-direction test and reset buttons.
- Class A rated GFCI.
- Supplied with matching TP26 nylon wall plate.
- Tri-drive screws.
- 10kA short circuit rating.

Specifications

- Supply Voltage: 125VAC, 60 Hz
- Supply Voltage Range: 102-132 VAC
- Trio Threshold: 5± 1mA
- Trip Time: 0.025 sec., nominal per UL Standard

CATALOG NUMBER	RATING		LIGHT OUTPUT IN 1' FCD*	COLOR	NEMA CONFIG. NO.	3rd PARTY COMPLIANCE		
	A.	VAC				UL943 C22.2 No. 144	UL498 C22.2 No. 42	FSUL WC596
NAFTA-COMPLIANT HOSPITAL GRADE 20 AMP DUPLEX GFCI								
PT2097HGNAI	20	125	0.180	Ivory	5-20R	•	•	•
PT2097HGNAW	20	125	0.180	White	5-20R	•	•	•
PT2097HGNAGRY	20	125	0.180	Gray	5-20R	•	•	•
PT2097HGNARED	20	125	0.180	Red	5-20R	•	•	•
NAFTA-COMPLIANT HOSPITAL GRADE TAMPER-RESISTANT 20 AMP DUPLEX GFCI								
PT2097HGTRNAI	20	125	0.180	Ivory	5-20R	•	•	•
PT2097HGTRNAW	20	125	0.180	White	5-20R	•	•	•
PT2097HGTRNAGRY	20	125	0.180	Gray	5-20R	•	•	•
NAFTA-COMPLIANT HOSPITAL GRADE TAMPER-RESISTANT 20 AMP COMBINATION NIGHT LIGHT/GFCI								
PT2097HGNTLTRNAI	20	125	0.180	Ivory	5-20R	•	•	•

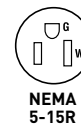

CATALOG NUMBER	WIRE TYPE	WIRE LENGTH
PLUGTAIL CONNECTORS - RIGHT ANGLE		
PTRA6STR	Stranded	6"
PTRA6SOL	Solid	6"

All PlugTail Connectors are available in any wire length up to 25 inches, consult factory to order.

NAFTA-Compliant GFCI Receptacles are ideal for use on projects subject to the provisions of the Buy American Act.

For additional PlugTail Connectors, see Page B-4.

GFCIs

radiant® RoHS-Compliant Spec Grade Tamper-Resistant Duplex GFCI Receptacles with SafeLock® Protection 2 Pole, 3 Wire Grounding 15 & 20A, 125VAC

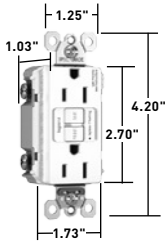

1597TRRW

The radiant® collection is a step up from the standard with simple, classic options in wiring devices, home automation controls, and screwless wall plates that complement today's homes and hospitality settings.

CATALOG NUMBER	RATING		COLOR	NEMA CONFIG. NO.	3rd PARTY COMPLIANCE		
	A.	VAC			UL943 C22.2 No. 144	UL498 C22.2 No. 42	FSUL WC596
ROHS-COMPLIANT RADIANT® SPEC GRADE TAMPER-RESISTANT 15 AND 20 AMP DUPLEX GFCI							
1597TRRI	15	125	Ivory	5-15R	•	•	•
1597TRRW	15	125	White	5-15R	•	•	•
1597TRRLA	15	125	Light Almond	5-15R	•	•	•
2097TRRI	20	125	Ivory	5-20R	•	•	•

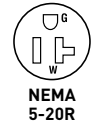

CATALOG NUMBER	COLOR
GFCI EXTENSION RINGS	
1594TPAI	7.0 cu. in. Extension Ring, Ivory
1594TPAW	7.0 cu. in. Extension Ring, White
1594TPA	7.0 cu. in. Extension Ring, Brown
1594TPALA	7.0 cu. in. Extension Ring, Light Almond



1594TPAW
EXTENSION RING

STRAIGHT BLADE RECEPTACLES

RoHS-Compliant GFCI Receptacles meet the requirements of Restriction of Hazardous Substances directives and regulations.

STRAIGHT BLADE RECEPTACLES

Hospital Grade Surge Protective Receptacles 2 Pole, 3 Wire Grounding 15 & 20A, 125VAC

Specifications

- UL1449 (3rd Edition). (1.2 x 50µs 6000V, 8 x 20µs 3000A).
- 24,000 amps current handling capability in each of 3 modes: line to neutral, line to ground, neutral to ground.
- LED indication: Steady green = protected; Flashing red = not protected OFF = no power to unit
- Response time less than 1 nanosecond for unmounted MOV.
- Overcurrent protection in all 3 modes.
- Printed circuit board conformally coated to protect against condensing humidity and airborne particulates.
- Thermal protection in all 3 modes.
- Leakage current: 0.5 mA at 25°C/120VAC.
- Common mode noise attenuation: 500 KHz to 30 MHz; up to 20 dB (50 ohm source impedance).

- Varistor voltage: 130V RMS.
- Back and side wire capability including ground terminal.
- Operating temperature: -40°C to 85°C (-40°F to 185°F).

5262/5362, IG5262/5362, 8200/8300, IG8200/8300, TR5262/5362, TRIG5262/5362, TR8200/8300, TRIG8200/8300

- 340 joules of energy absorption in each of the 3 modes. Energy (measured for an 8x20µs duration) = 340J.
- Nominal let-through (suppressed) voltage in all 3 modes, 500V.
- Audible alarm able to be turned on/off.
- 3 17mm dual pack MOVs to suppress transients in all modes – equally.
- Isolated Ground version complies with NEC 410-56 (C) and 250-146.

5252/5352, TR5252/5352, All PlugTail®

- 340 joules of energy absorption in line-to-neutral and line-to-ground modes. 680 joules of energy absorption in neutral-to-ground mode. Energy (measured for an 8x20µs duration) = 340J; 680J for N-G mode.
- 2 17mm dual pack MOVs to suppress transients in all modes – equally.
- Nominal let-through (suppressed) voltage: Line-to-neutral and line-to-ground modes = 500V; neutral-to-ground = 1000V.
- PlugTail versions – factory-terminated devices and connectors.

Audible Alarm with LED Indicator

CATALOG NUMBER	RATING		COLOR	NEMA CONFIG. NO.	3rd PARTY COMPLIANCE			
	A.	VAC			UL1449	UL498	FSUL WC596	cUL/CSA
DUPLEX RECEPTACLES BACK & SIDE WIRE								
8200ISP	15	125	Ivory	5-15R	•	•	•	•
8200WSP	15	125	White	5-15R	•	•	•	•
8200SP	15	125	Brown	5-15R	•	•	•	•
8200REDSP	15	125	Red	5-15R	•	•	•	•
8200BLSP	15	125	Blue	5-15R	•	•	•	•
8300ISP	20	125	Ivory	5-20R	•	•	•	•
8300WSP	20	125	White	5-20R	•	•	•	•
8300SP	20	125	Brown	5-20R	•	•	•	•
8300GRYSP	20	125	Gray	5-20R	•	•	•	•
8300REDSP	20	125	Red	5-20R	•	•	•	•
8300LASP	20	125	Light Almond	5-20R	•	•	•	•
8300BLSP	20	125	Blue	5-20R	•	•	•	•
ISOLATED GROUND DUPLEX RECEPTACLES BACK & SIDE WIRE								
IG8200ISP	15	125	Ivory	5-15R	•	•	•	•
IG8200WSP	15	125	White	5-15R	•	•	•	•
IG8200BLSP	15	125	Blue	5-15R	•	•	•	•
IG8200OSP	15	125	Orange	5-15R	•	•	•	•
IG8300ISP	20	125	Ivory	5-20R	•	•	•	•
IG8300WSP	20	125	White	5-20R	•	•	•	•
IG8300GRYSP	20	125	Gray	5-20R	•	•	•	•
IG8300BLSP	20	125	Blue	5-20R	•	•	•	•
IG8300OSP	20	125	Orange	5-20R	•	•	•	•

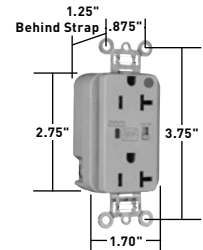

8300GRYSP

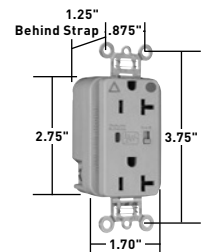

IG8300GRYSP

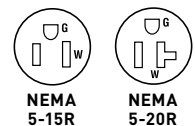

NEMA 5-15R

NEMA 5-20R

Conforms to the latest revision ANSI/IEEE C62.41 (formerly IEEE587), ANSI/IEEE C62.45.

All devices listed on this page conform to NEMA WD-1 and WD-6.

STRAIGHT BLADE RECEPTACLES

Surge Protective Receptacles 2 Pole, 3 Wire Grounding 15 & 20A, 125VAC

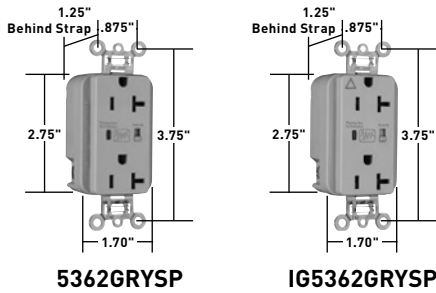

Audible Alarm with LED Indicator

CATALOG NUMBER	RATING		COLOR	NEMA CONFIG. NO.	3rd PARTY COMPLIANCE			
	A.	VAC			UL1449	UL498	FSUL WC596	cUL/CSA
EXTRA HEAVY-DUTY DUPLEX RECEPTACLES BACK & SIDE WIRE								
5262ISP	15	125	Ivory	5-15R	•	•	•	•
5262WSP	15	125	White	5-15R	•	•	•	•
5262SP	15	125	Brown	5-15R	•	•	•	•
5262BKSP	15	125	Black	5-15R	•	•	•	•
5262REDSP	15	125	Red	5-15R	•	•	•	•
5262LASP	15	125	Light Almond	5-15R	•	•	•	•
5262BLSP	15	125	Blue	5-15R	•	•	•	•
5362ISP	20	125	Ivory	5-20R	•	•	•	•
5362WSP	20	125	White	5-20R	•	•	•	•
5362SP	20	125	Brown	5-20R	•	•	•	•
5362GRYSP	20	125	Gray	5-20R	•	•	•	•
5362BKSP	20	125	Black	5-20R	•	•	•	•
5362REDSP	20	125	Red	5-20R	•	•	•	•
5362LASP	20	125	Light Almond	5-20R	•	•	•	•
5362BLSP	20	125	Blue	5-20R	•	•	•	•
ISOLATED GROUND DUPLEX RECEPTACLES BACK & SIDE WIRE								
IG5262ISP	15	125	Ivory	5-15R	•	•	•	•
IG5262WSP	15	125	White	5-15R	•	•	•	•
IG5262GRYSP	15	125	Gray	5-15R	•	•	•	•
IG5262BLSP	15	125	Blue	5-15R	•	•	•	•
IG5262OSP	15	125	Orange	5-15R	•	•	•	•
IG5362ISP	20	125	Ivory	5-20R	•	•	•	•
IG5362WSP	20	125	White	5-20R	•	•	•	•
IG5362SP	20	125	Brown	5-20R	•	•	•	•
IG5362GRYSP	20	125	Gray	5-20R	•	•	•	•
IG5362LASP	20	125	Light Almond	5-20R	•	•	•	•
IG5362BLSP	20	125	Blue	5-20R	•	•	•	•
IG5362OSP	20	125	Orange	5-20R	•	•	•	•

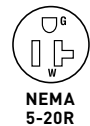
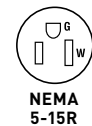

STRAIGHT BLADE RECEPTACLES

All devices listed on this page conform to NEMA WD-1 and WD-6.
Conforms to the latest revision ANSI/IEEE C62.41 (formerly IEEE587), ANSI/IEEE C62.45.

STRAIGHT BLADE RECEPTACLES

PlugTail® Spec & Hospital Grade Surge Protective Receptacles

2 Pole, 3 Wire Grounding, 15 & 20A, 125VAC

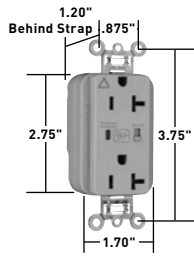

PTIG5362GRYSP

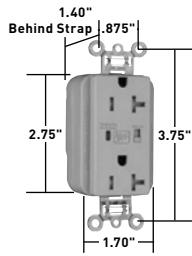

PTTR5362GRYSP

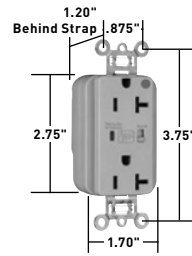

PT8300GRYSP

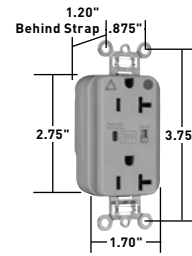

PTIG8300GRYSP

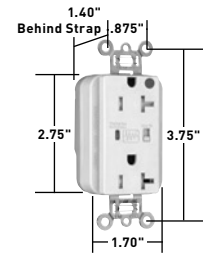

PTTR8300ISP

CATALOG NUMBER		RATING		COLOR	NEMA CONFIG. NO.	3rd PARTY COMPLIANCE			
SPEC GRADE	HOSPITAL GRADE	A.	V.			UL1449	UL498	FSUL WC596	cUL/CSA
EXTRA HEAVY-DUTY DUPLEX RECEPTACLES									
PT5262ISP	PT8200ISP	15	125	Ivory	5-15R	•	•	•	•
PT5262WSP	PT8200WSP	15	125	White	5-15R	•	•	•	•
	PT8200SP	15	125	Brown	5-15R	•	•	•	•
PT5262GRYSP		15	125	Gray	5-15R	•	•	•	•
PT5262BLSP	PT8200BLSP	15	125	Blue	5-15R	•	•	•	•
PT5362ISP	PT8300ISP	20	125	Ivory	5-20R	•	•	•	•
PT5362WSP	PT8300WSP	20	125	White	5-20R	•	•	•	•
PT5362SP	PT8300SP	20	125	Brown	5-20R	•	•	•	•
PT5362GRYSP	PT8300GRYSP	20	125	Gray	5-20R	•	•	•	•
	PT8300REDSP	20	125	Red	5-20R	•	•	•	•
PT5362BKSP		20	125	Black	5-20R	•	•	•	•
PT5362LASP		20	125	Light Almond	5-20R	•	•	•	•
PT5362BLSP	PT8300BLSP	20	125	Blue	5-20R	•	•	•	•
ISOLATED GROUND DUPLEX RECEPTACLES									
	PTIG8200REDSP	15	125	Red	5-15R	•	•	•	•
PTIG5262WSP		15	125	White	5-15R	•	•	•	•
	PTIG8200LASP	15	125	Light Almond	5-15R	•	•	•	•
PTIG5262OSP	PTIG8200OSP	15	125	Orange	5-15R	•	•	•	•
PTIG5362ISP		20	125	Ivory	5-20R	•	•	•	•
PTIG5362WSP		20	125	White	5-20R	•	•	•	•
	PTIG8300SP	20	125	Brown	5-20R	•	•	•	•
PTIG5362GRYSP		20	125	Gray	5-20R	•	•	•	•
	PTIG8300REDSP	20	125	Red	5-20R	•	•	•	•
PTIG5362BKSP		20	125	Black	5-20R	•	•	•	•
PTIG5362LASP		20	125	Light Almond	5-20R	•	•	•	•
	PTIG8300BLSP	20	125	Blue	5-20R	•	•	•	•
PTIG5362OSP	PTIG8300OSP	20	125	Orange	5-20R	•	•	•	•
TAMPER-RESISTANT DUPLEX RECEPTACLES									
PTTR5262WSP	PTTR8200WSP	15	125	White	5-15R	•	•	•	•
PTTR5262SP		15	125	Brown	5-15R	•	•	•	•
	PTTR8200REDSP	15	125	Red	5-15R	•	•	•	•
	PTTR8200BLSP	15	125	Blue	5-15R	•	•	•	•
PTTR5362ISP	PTTR8300ISP	20	125	Ivory	5-20R	•	•	•	•
PTTR5362WSP	PTTR8300WSP	20	125	White	5-20R	•	•	•	•
PTTR5362GRYSP	PTTR8300GRYSP	20	125	Gray	5-20R	•	•	•	•
	PTTR8300REDSP	20	125	Red	5-20R	•	•	•	•
PTTR5362LASP		20	125	Light Almond	5-20R	•	•	•	•
PTTR5362BLSP	PTTR8300BLSP	20	125	Blue	5-20R	•	•	•	•

For PlugTail Connectors, see Page B-4.

All devices listed on this page conform to NEMA WD-1 and WD-6. Conforms to the latest revision ANSI/IEEE C62.41 (formerly IEEE587), ANSI/IEEE C62.45.

All devices listed on this page conform to NEMA WD-1 and WD-6.

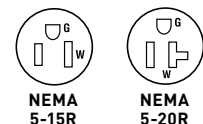

STRAIGHT BLADE RECEPTACLES

Tamper-Resistant Spec & Hospital Grade Surge Protective Receptacles

2 Pole, 3 Wire Grounding, 15 & 20A, 125VAC

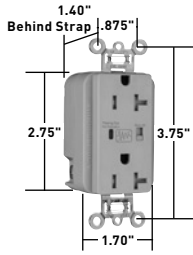

TR5362GRYSP

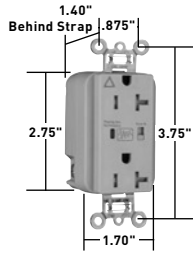

TRIG5362GRYSP

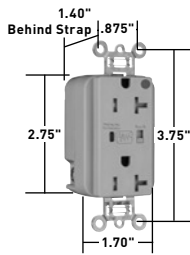

TR8300GRYSP

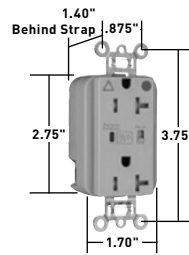

TRIG8300GRYSP

Audible Alarm with LED Indicator

CATALOG NUMBER		RATING		COLOR	NEMA CONFIG. NO.	3rd PARTY COMPLIANCE			
SPEC GRADE	HOSPITAL GRADE	A.	VAC			UL1449	UL498	FSUL WC596	cUL/CSA
EXTRA HEAVY-DUTY DUPLEX RECEPTACLES BACK & SIDE WIRE									
TR5262ISP		15	125	Ivory	5-15R	•	•	•	•
TR5262WSP	TR8200WSP	15	125	White	5-15R	•	•	•	•
TR5262SP	TR8200SP	15	125	Brown	5-15R	•	•	•	•
TR5262GRYSP		15	125	Gray	5-15R	•	•	•	•
	TR8200REDSP	15	125	Red	5-15R	•	•	•	•
TR5262LASP	TR8200LASP	15	125	Light Almond	5-15R	•	•	•	•
TR5262BLSP		15	125	Blue	5-15R	•	•	•	•
TR5362ISP	TR8300ISP	20	125	Ivory	5-20R	•	•	•	•
TR5362WSP	TR8300WSP	20	125	White	5-20R	•	•	•	•
TR5362SP		20	125	Brown	5-20R	•	•	•	•
TR5362GRYSP		20	125	Gray	5-20R	•	•	•	•
TR5362BKSP		20	125	Black	5-20R	•	•	•	•
	TR8300REDSP	20	125	Red	5-20R	•	•	•	•
TR5362LASP		20	125	Light Almond	5-20R	•	•	•	•
TR5362BLSP	TR8300BLSP	20	125	Blue	5-20R	•	•	•	•
ISOLATED GROUND DUPLEX RECEPTACLES BACK & SIDE WIRE									
TRIG5262WSP	TRIG8200WSP	15	125	White	5-15R	•	•	•	•
	TRIG8200REDSP	15	125	Red	5-15R	•	•	•	•
TRIG5262BLSP	TRIG8200BLSP	15	125	Blue	5-15R	•	•	•	•
TRIG5262OSP		15	125	Orange	5-15R	•	•	•	•
TRIG5362ISP	TRIG8300ISP	20	125	Ivory	5-20R	•	•	•	•
TRIG5362WSP	TRIG8300WSP	20	125	White	5-20R	•	•	•	•
	TRIG8300REDSP	20	125	Red	5-20R	•	•	•	•
TRIG5362LASP		20	125	Light Almond	5-20R	•	•	•	•
	TRIG8300BLSP	20	125	Blue	5-20R	•	•	•	•
TRIG5362OSP	TRIG8300OSP	20	125	Orange	5-20R	•	•	•	•

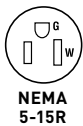

STRAIGHT BLADE RECEPTACLES

All devices listed on this page conform to NEMA WD-1 and WD-6.
Conforms to the latest revision ANSI/IEEE C62.41 (formerly IEEE587), ANSI/IEEE C62.45.

STRAIGHT BLADE RECEPTACLES

Quad Receptacles & Accessories 15 & 20A, 125V

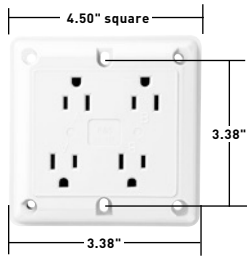

Quad Receptacle

Application

Pass & Seymour® quad receptacles are designed for dense, multiple-outlet applications such as personal computers and peripherals, office equipment, and home entertainment centers. The bidirectional outlet configuration allows use of up to four oversized plugs, in close proximity. The clean, contemporary design of the quad receptacle allows for surface mounting with minimal protrusion from the wall. No wall plate is required.

Features

- Rugged nylon face and body withstands impacts and hard use.
- Built-in wire stripping gauge.
- Outward-facing ground terminals make handling up to four straight or angled plugs easy and convenient.
- Heavy-duty, phosphor bronze contacts.
- Shielding walls guard against live-circuit-to-ground shorts.
- Split circuit break-off tabs.
- UL and CSA listed.

CATALOG NUMBER	RATING		COLOR	NEMA CONFIG. NO.	3rd PARTY COMPLIANCE		
	A.	V.			UL UL498	UL UL1449	CSA
HOSPITAL GRADE ISOLATED GROUND SURGE PROTECTIVE QUADS							
IG420HISP	20	125	Ivory	5-20R	•	•	
IG420HBLSP	20	125	Blue	5-20R	•	•	
HOSPITAL GRADE QUADS							
420HI	20	125	Ivory	5-20R	•		•
420HW	20	125	White	5-20R	•		•
420H	20	125	Brown	5-20R	•		•
420HGRY	20	125	Gray	5-20R	•		•
420HRED	20	125	Red	5-20R	•		•
SPECIFICATION GRADE SURGE PROTECTIVE QUADS							
420BLSP	20	125	Blue	5-20R	•	•	
SPECIFICATION ISOLATED GRADE QUADS							
IG420	20	125	Orange	5-20R	•		•
SPECIFICATION GRADE QUADS							
415I	15	125	Ivory	5-15R	•		•
415W	15	125	White	5-15R	•		•
415GRY	15	125	Gray	5-15R	•		•
420I	20	125	Ivory	5-20R	•		•
420W	20	125	White	5-20R	•		•
420GRY	20	125	Gray	5-20R	•		•
QUAD ADAPTER PLATES							
4API			Ivory		•	•	
4APW			White		•	•	
4AP			Brown		•	•	
4APRED			Red		•	•	

2 Pole, 3 Wire

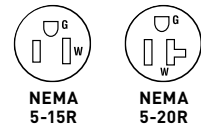

STRAIGHT BLADE RECEPTACLES

STRAIGHT BLADE RECEPTACLES

Quad Receptacles Specifications

Hard Use Spec Grade & Hard Use Surge Protective Spec Grade Quads

- Isolated ground complied with NEC® 410-56(c) and 250-74 exception 4
- Conforms to NEMA WD-1, WD-6.

Electrical

Frequency: 60Hz
Voltage: 125V

Mechanical

Terminal Identification: Brass = Hot, Nickel = Neutral, Green = Ground
Terminal Accommodation: #14 -12 AWG copper and copper-clad
Product Identification: Ratings are permanent part of device
Weight: 10.75 oz.

Environmental

Flammability: UL94 V2
Operating Temperature: -40°C to 65°C (-40°F to 150°F) continuous without impact

Materials

Face: Nylon
Body: Nylon
Line Terminals: .035" T-type Triple-Wipe Phosphor Bronze
Terminal Screws: Brass #8-32
Hex Head Grounding Screw: Steel (Green)
Mounting Screws: Zinc-plated steel

Additional Specifications for Hard Use Surge Protective Spec Grade Quads

- ANSI /IEEE C62.41 (formerly IEEE 587), ANSI/IEEE C62.45
- Installation Categories "A" (ring wave) and "B" (unidirectional impulse)

Electrical

MOV Rating: 18mm
UL1449 Suppressed
Voltage Rating: 500V (L-N, L-G, N-G)
Noise Attenuation: -35db Noise Filtering at 5kHz-50MHz
Thermal Protection: Fused
Green LED Indicator: ON when protection is active, OFF when protection is inactive

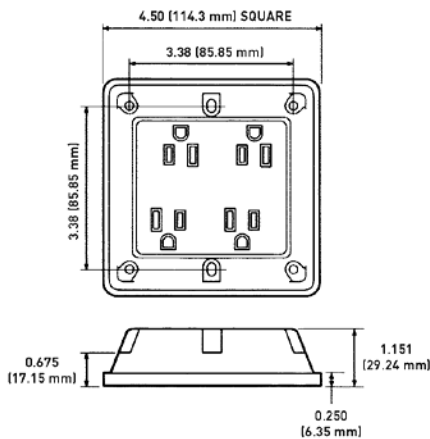

Quad Receptacle

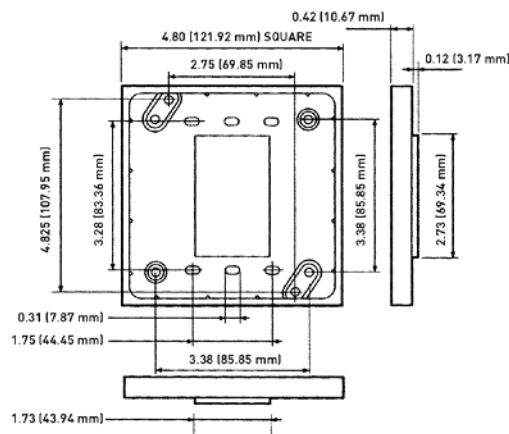

Adapter Plate

STRAIGHT BLADE RECEPTACLES

Dust & Moisture Resistant & Clock Hanger Receptacles 15 & 20A, 125V

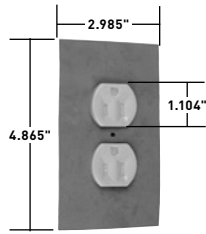

6207
shown with neoprene
sealing mat

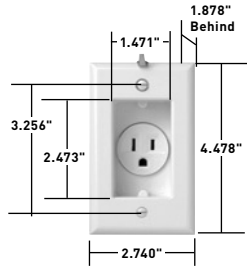

S37131

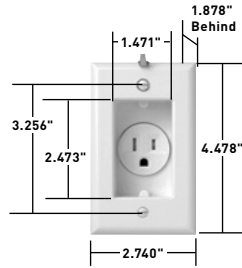

S3713TRI

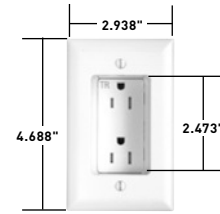

R885TRWCC6

Features – Dust & Moisture Resistant

- Duplex receptacle has face backed by neoprene gasket which is slit to provide wiping action on plug blades and to provide positive closure when not in use.
- Cellular neoprene sealing mat fits under wall plate.

CATALOG NUMBER	RATING		COLOR	NEMA CONFIG. NO.	3rd PARTY COMPLIANCE		
	A.	V.			UL498	FSUL WC596	C22.2 No. 42
DUST & MOISTURE RESISTANT							
6207	15	125	Duplex, Dust and Moisture Resistant, Gray	5-15R	•	•	•
6307	20	125	Duplex, Dust and Moisture Resistant, Gray	5-20R	•	•	•
CR6307	20	125	Duplex, Corrosion, Dust and Moisture Resistant, Yellow	5-20R	•	•	•

CATALOG NUMBER	RATING		COLOR	NEMA CONFIG. NO.	3rd PARTY COMPLIANCE		
	A.	V.			UL498	FSUL WC596	C22.2 No. 42
CLOCK HANGERS							
S37131	15	125	Recessed Receptacle with Ivory Smooth Wall Plate	5-15R	•	•	•
S3713W	15	125	Recessed Receptacle with White Smooth Wall Plate	5-15R	•	•	•
S3713GRY	15	125	Recessed Receptacle with Gray Smooth Wall Plate	5-15R	•	•	•
S3713BK	15	125	Recessed Receptacle with Black Smooth Wall Plate	5-15R	•	•	•
S3713LA	15	125	Recessed Receptacle with Light Almond Smooth Wall Plate	5-15R	•	•	•
S3733SS	15	125	Recessed Receptacle with Stainless Steel Wall Plate	5-15R	•	•	•
S3733	15	125	Recessed Receptacle with Brass Wall Plate	5-15R	•	•	•
TAMPER-RESISTANT CLOCK HANGERS BACK & SIDE WIRE							
S3713TRI	15	125	Recessed Receptacle with Ivory Smooth Wall Plate	5-15R	•	•	•
S3713TRW	15	125	Recessed Receptacle with White Smooth Wall Plate	5-15R	•	•	•
S3713TRGRY	15	125	Recessed Receptacle with Gray Smooth Wall Plate	5-15R	•	•	•
S3713TRBK	15	125	Recessed Receptacle with Black Smooth Wall Plate	5-15R	•	•	•
S3713TRLA	15	125	Recessed Receptacle with Light Almond Smooth Wall Plate	5-15R	•	•	•

CATALOG NUMBER	RATING		COLOR	NEMA CONFIG. NO.	3rd PARTY COMPLIANCE
	A.	V.			cULus
RECESSED DUPLEX TAMPER-RESISTANT RECEPTACLE					
R885TRWCC6	15	125	White	5-15R	•

2 Pole, 3 Wire

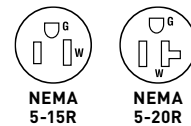

STRAIGHT BLADE RECEPTACLES

Power Outlet Receptacles & Plugs 20, 30, 50, & 60A

RATING		RECEPTACLE/PLUG CONFIGURATION & NEMA NO.							
A.	V.		FLUSH RECEPTACLE	WALL PLATE <small>*For 2 screw mounting **For 4 screw mounting</small>	SURFACE RECEPTACLE	PLUG	ANGLE PLUG	CONNECTOR	
		CATALOG NUMBERS							
2 POLE, 3 WIRE GROUNDING									
30	125	5-30			3802§ AL/CU	1-Gang: TP724* 2-Gang: SS702* 2-Gang: TP703**	D0531 .57"-1.26"	D0533 .57"-1.26"	
30	125	NEMA TT30			3830 AL/CU	1-Gang: TP724* 2-Gang: SS702* 2-Gang: TP703**			
For recreational vehicles.									
30	250	6-30			3801 AL/CU	1-Gang: TP724* 2-Gang: SS702* 2-Gang: TP703**	D0631 .57"-1.26"	3869 D0633 .57"-1.26"	
50	125	5-50					D0551 .57"-1.26"	D0553 .57"-1.26"	
50	250	6-50			3804§ AL/CU	1-Gang: TP724* 2-Gang: SS702* 2-Gang: TP703**	D0651 .57"-1.26"	3869 D0653 .57"-1.26"	
3 POLE, 3 WIRE NON-GROUNDING									
30	125/250 Dryer	10-30			3860 AL/CU	1-Gang: TP724* 2-Gang: SS702* 2-Gang: TP703**	388 AL/CU	1031 3861	
50	125/250 Range	10-50			3890§ AL/CU	1-Gang: TP724* 2-Gang: SS702* 2-Gang: TP703**	385 AL/CU	1051 .57"-1.26" 3861 1053 .32"-.91"	
3 POLE, 4 WIRE GROUNDING									
20	125/250	14-20			3820	1-Gang: SS7*			
30	125/250 Dryer	14-30			3864 AL/CU 3864NA†	2-Gang: SS702* 2-Gang: TP703**	3884#/388440‡ AL/CU	1431 .57"-1.26" 5746AN 3867	
30	3ø, 250	15-30			5740 AL/CU	2-Gang: SS702* 2-Gang: TP703**		5741AN	
50	125/250 Range	14-50			3894§ AL/CU 3894NA†	2-Gang: SS702* 2-Gang: TP703**	3854#/385440‡ AL/CU	1451 .57"-1.26" 5745AN 3867	
50	3ø, 250	15-50			5750 AL/CU	2-Gang: SS702* 2-Gang: TP703**		5751AN	
60	3ø, 250	15-60			5760 AL/CU	2-Gang: SS702* 2-Gang: TP703**	8462N	5761AN	
4 POLE, 4 WIRE NON-GROUNDING									
20	3øY, 120/208	18-20			3822	1-Gang: SS7*	7251DF .35"-1.05"		
60	3øY, 120/208	18-60			3870§ AL/CU	2-Gang: SS701**	D1861 .57"-1.26"	8302AN	

† In bulk pack of 40 with plastic snap-in wire clamp.

§ Up to #3 AWG aluminum conductors.

Up to #4 AWG aluminum conductors.

For further information consult Wall Plate Section S (for Stainless Steel versions of TP724 and TP703, refer to Pages S-13 and S-14).

† NAFTA-Compliant Receptacles are ideal for use on projects subject to the provisions of the Buy American Act.

STRAIGHT BLADE RECEPTACLES

STRAIGHT BLADE RECEPTACLES

Power Outlet Receptacles & Plugs 20, 30, 50, & 60A

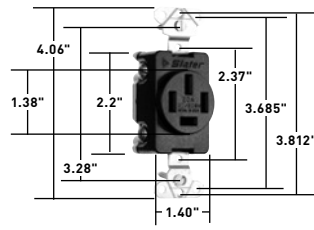

3822

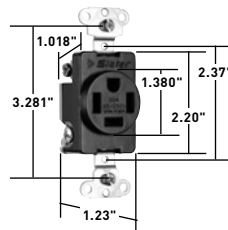

3820



**385 3854
388 3884
3852**

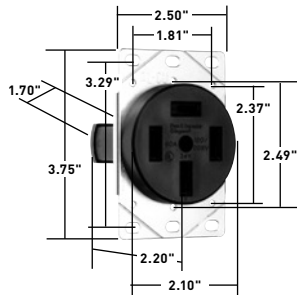

3870

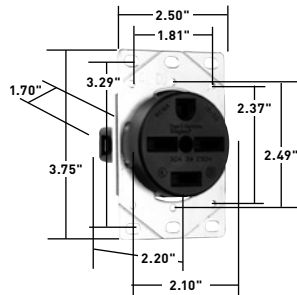

**3801 3802
3804 3864
3894 5740
5750 5760**

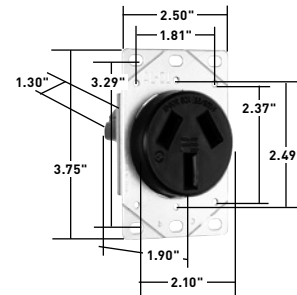

**3830
3860
3890**

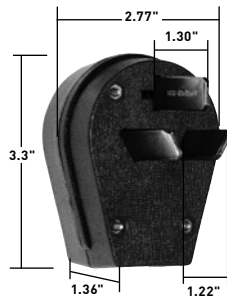

3861

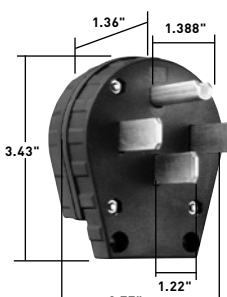

3867

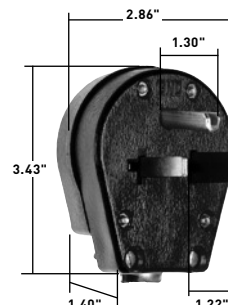

3869

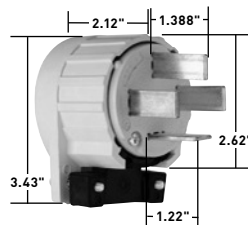

**5741AN 5751AN
5745AN 5761AN
5746AN 8302AN**

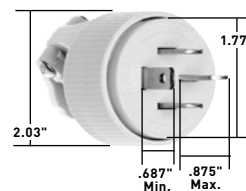

7251DF

STRAIGHT BLADE RECEPTACLES

STRAIGHT BLADE RECEPTACLES

Power Outlet Receptacles & Plugs 20, 30, 50 & 60A



Flush Receptacle



Surface Receptacle



Angle Plug



Plug

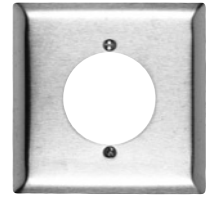

Wall Plate

Application

Power devices are for use in industrial, institutional, commercial, and certain residential applications to provide higher amperage power to equipment such as air conditioners, copiers, small welders, ranges, and dryers.

Features

- Flush receptacle bodies are molded of arc-resistant plastic.
- All devices are of dead front design.
- Receptacles have double-wipe contacts of high performance copper-based alloy.
- Recommended stainless steel wall plates are listed with each flush receptacle.
- UL Listed for use with aluminum wiring.

RECEPTACLE AMP. RATING	AWG SIZE	MATERIAL
CONDUCTOR SIZE & MATERIAL FOR POWER OUTLET RECEPTACLES		
20A	#14 – #10	Copper/Copper-clad
30A	#10 – #6	Copper/Copper-clad/Aluminum
50A	#10 – #6	Copper/Copper-clad/Aluminum
60A	#8 – #4	Copper/Copper-clad/Aluminum

AMPERE RATING	WITH NON-METALLIC SHEATHED CABLE	WITH CONDUIT
RECOMMENDED BOX SIZES FOR FLUSH RECEPTACLES		
30A	4" sq. x 2-1/8" deep	4-11/16" sq. x 2-1/8" deep
50A	4-11/16" sq. x 2-1/8" deep	2-g deep box [4" sq. x 2-1/2" deep]
60A	4-11/16" sq. x 2-1/8" deep with 1/2" raised ring	2-g deep box [4" sq. x 2-1/2" deep]

DESCRIPTION	COLOR	NYLON	METAL		WALL PLATES RECOMMENDED FOR THE FOLLOWING FLUSH RECEPTACLES	
		TRADEMASTER®	MATERIAL			
ACCESSORIES – FLUSH RECEPTACLE WALL PLATES						
 • 2.156" hole for 2.125" dia. device • 2 mtg. holes	Ivory	TP724I			2 Pole, 3 Wire Grounded	
	White	TP724W			3801	3804
	Brown	TP724	Chrome	S384C	3802	3830
	Gray	TP724GRY				
	Black	TP724BK				
 • 2-5/32" hole for 2-1/8" dia. device • 2 mtg. holes	Light Almond	TP724LA	302S/S	SS724		
			302S/S	SS702	3 Pole, 3 Wire Ungrounded	
 • 2.1563" hole for 2.125" dia. device • 4 mtg. holes					3 Pole, 4 Wire Ungrounded	
	Ivory	TP703I			3864	5740
	White	TP703W	Chrome	S3862C		
	Brown	TP703	302S/S	SS703	3894	5750
	Gray	TP703GRY				5760
Black	TP703BK					
Light Almond	TP703LA					

New Installations require 4 wire range and dryer outlets. Ref: 2002 NEC 250-134, 250-138
 Existing Installations permitted to use 3 wire range and dryer outlets. Ref: 2002 NEC 250-140

STRAIGHT BLADE RECEPTACLES

STRAIGHT BLADE RECEPTACLES

Miscellaneous Configurations Straight Blade Receptacles, 3 Wire, Specification Grade

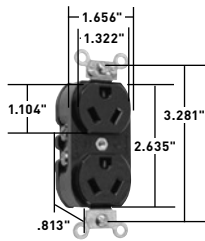

5762

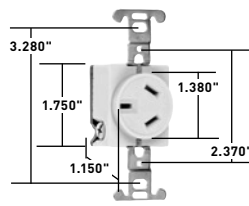

6810I

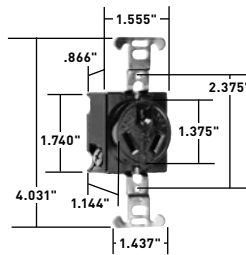

7621

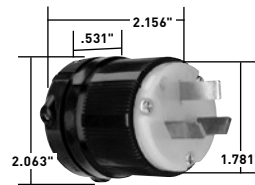

9977

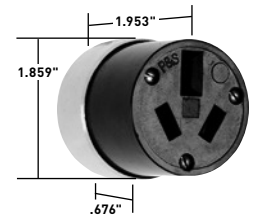

7088

CATALOG NUMBER	RATING		DESCRIPTION	NEMA CONFIG. NO.	3rd PARTY COMPLIANCE		
	A.	V.			UL498	FSUL WC596	C22.2 No. 42
POLE, 3 WIRE GROUNDING							
5762	15	277	Duplex Receptacle, Self-Grounding	7-15R	•		
PS5766X	15	277	Plug, Yellow	7-15P	•		•
7621	20	277	Single Receptacle	7-20R	•		
PS5866X	20	277	Plug, Yellow	7-20P	•		•
3 POLE, 3 WIRE NON-GROUNDING							
6810I	20	125/250	Receptacle, Ivory	10-20R	•		
6810	20	125/250	Receptacle, Black	10-20R	•		
9977	20	125/250	Plug, Nylon	10-20P			
7088	20	125/250	Connector, Armored	10-20R			



NEMA 7-15P



NEMA 7-15R



NEMA 7-20P



NEMA 7-20R



NEMA 10-20P



NEMA 10-20R

STRAIGHT BLADE RECEPTACLES

Power & Surge Protection Strips

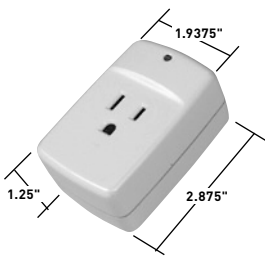

TAP - PS1

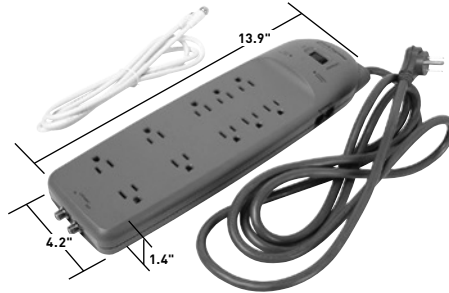

BLOCK - PS10PC

Application

There are an average of over 250 power disturbances per year in each home or office in the United States. Over 8% data loss is a direct result from lightning and the value of equipment and data is sometimes much greater than that of equipment.

Surges and spikes can come through power lines as well as phone and coax lines. So choose a protector which includes phone and/or coax protection.

Features

- 400V clamping voltage.
- UL1449 listed.
- Heavy-duty cord from 3' to 15', depending on device.
- Multiple function protection available for power, phone, fax, modem, coax or data.
- Extremely long life with dependable protection.
- Surge protection indicator on surge devices.
- Circuit breaker switch.
- Heavy-duty high-energy MOVs.
- Ground continuity indicator.

Protection Specifications

- Line protection modes: L-N, L-G, N-G.
- Spike protection for sudden, dramatic surges, over 400V.
- Surge protection lasts for 1/120 of a second, for moderate short term overvoltage.
- EMI/RFI noise attenuation.

CATALOG NUMBER	RATING		TYPE OF HOUSING	# OF OUTLETS	CORD LENGTH	JOULE RATING RANGE	MAX. SPIKE CURRENT (AMPS)	TYPE OF PROTECTION		COLOR
	A.	V.						PHONE/FAX	COAX	
POWER STRIPS WITH SURGE PROTECTION										
PS1	15	125	Tap	1		740J	48K			PC Gray
PS6	15	125	Strip	6	3'	555J	36K			PC Gray
PS7	15	125	Strip	7	6'	740J	48K			PC Gray
PS7P	15	125	Strip	7	6'	740J	48K	X		PC Gray
PS7L	15	125	Strip	7	15'	740J	48K			PC Gray
PS8C	15	125	Block	8	8'	1100J	72K		X	PC Gray
PS8P	15	125	Block	8	8'	1100J	72K	X		PC Gray
PS10PC	15	125	Block	10	8'	1100J	72K	X	X	PC Gray

STRAIGHT BLADE RECEPTACLES

Surge Protection Strips Specifications

Power & Surge Protection Devices – Ratings

Catalog Number	PS1	PS6	PS7	PS7P	PS7L	PS8C	PS8P	PS10PC
Type of Housing	Tap	Strip	Strip	Strip	Strip	Block	Block	Block
Number of Outlets	1	6	7	7	7	8	8	10
Standard Grounded Outlets	1	6	6	6	6	0	0	6
Transformer Ready Outlets	1	0	1	1	1	8	8	4
Joule Rating Range	740J	555J	740J	740J	740J	1100J	1100J	1100J
MOV Configuration	4-20mm	3-20mm	4-20mm	4-20mm	4-20mm	6-20mm	6-20mm	6-20mm
Clamping Voltage	400V	400V	400V	400V	400V	400V	400V	400V
Max. Spike Current (Amps)	48K	36K	48K	48K	48K	72K	72K	72K
EMI Filter Capacitors	X		X	X	X	X	X	X
Protection (L-N, L-G, N-G)	X	X	X	X	X	X	X	X
Surge Protection Indicator	X	X	X	X	X	X	X	X
Ground/Wiring Indicator			X	X	X	X	X	X
Circuit Breaker Switch		Unlighted	Lighted	Lighted	Lighted	Lighted	Lighted	Lighted
Cord Length (exposed) ft.		3'	6'	6'	15'	8'	8'	8'
Plug		Straight	Straight	Straight	Straight	Rt. Angle	Rt. Angle	Rt. Angle
Phone/Fax Protection				X			X	X
Phone Line(s) Configuration				1 in/1 out			1 in/2 out	1 in/1 out
Phone Jack Spec				RJ-11			RJ-45	RJ-45
Nickel-Coaxial Jack Protection						X		X
6' Phone Cable (6P2C)				X			X	X
6' Coax Cable (Nickel Plated)						X		X
Molded Add-On Safety Covers	0	0	2	2	2	4	4	5
Molded Housing Color	PC Gray	PC Gray	PC Gray	PC Gray	PC Gray	PC Gray	PC Gray	PC Gray
UL1449 2nd Edition	X	X	X	X	X	X	X	X

DEVICES & WALL PLATES

Color Selection Chart

Devices & Plastic Wall Plate Colors

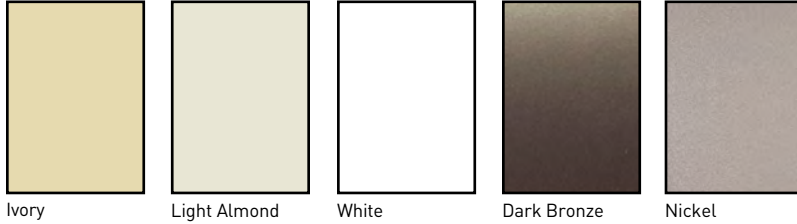

Ivory Light Almond White Dark Bronze Nickel

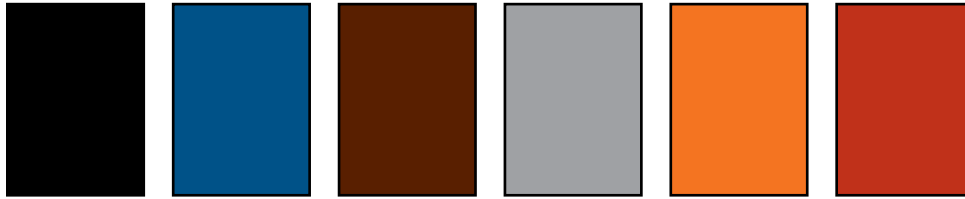

Black Blue Brown Gray Orange Red

See specific device and wall plate catalog charts for particular color availabilities.

Metal Wall Plates

Metal Finish



Aluminum Polished Brass Stainless Steel Brushed Bronze Chrome

Custom Metal Wall Plates Paint Finish Colors

Paint Color

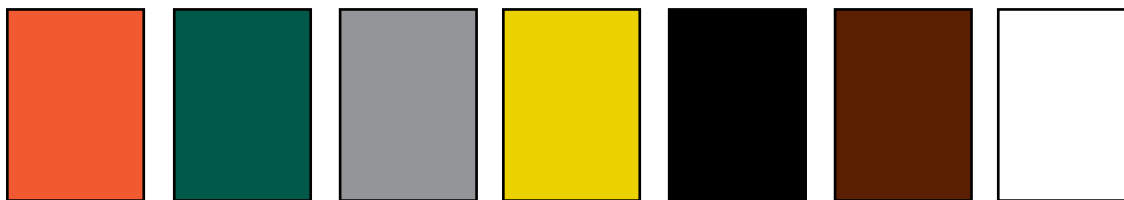

Orange Green Gray Yellow Glossy Black Brown White

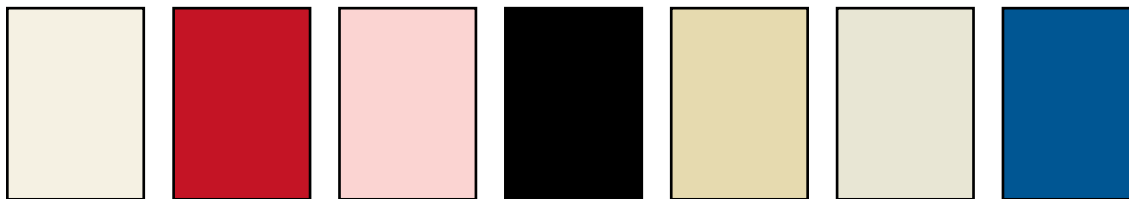

Primer Red Pink Flat Black Ivory Light Almond Blue

To order custom metal wall plates, see Pages S-40 – S-44.

For additional colors consult factory.

STRAIGHT BLADE RECEPTACLES

GFCIs



Featured Products



SELF-TEST GFCI RECEPTACLES

C-2



PLUGTAIL® TAMPER-RESISTANT GFCI RECEPTACLES

C-15



ISOLATED-GROUND GFCI RECEPTACLES

C-12

Self-Test GFCI Receptacles with SafeLock® Protection	C-2
Tamper-Resistant GFCIs	C-3
Hospital Grade Tamper-Resistant GFCIs	C-4
Specification Grade Dead Front GFCIs	C-7
Tamper-Resistant Switch/GFCIs	C-8
Tamper-Resistant Night Light/GFCIs	C-9
Weather-Resistant GFCIs	C-10
Audible Alarm GFCIs	C-11
Isolated-Ground GFCIs	C-12
PlugTail® Specification Grade GFCIs	C-13
PlugTail® Hospital Grade GFCIs	C-14

PlugTail® Spec & Hospital Grade Tamper-Resistant GFCIs	C-15
PlugTail® Spec & Hospital Grade Tamper-Resistant Night Light/GFCIs	C-16
NAFTA-Compliant GFCIs	C-17
NAFTA-Compliant Hospital Grade	C-18
NAFTA-Compliant PlugTail® GFCIs	C-19
NAFTA-Compliant PlugTail® Hospital Grade GFCIs	C-20
RoHS-Compliant GFCIs	C-21
Extension Rings	C-21
GFCI Portables	C-22

GFCIs

radiant® & Specification Grade Self-Test GFCI Receptacle with SafeLock® Protection

1597TRW

Self-Test GFCI Receptacles with SafeLock® Protection

When we invented the first GFCI receptacle, our goal was to keep people safe. Today, because of their proven effectiveness, they are required by code in numerous locations. That's why we've made it our mission to offer intelligently designed solutions for every residential and commercial environment.

Whether the jobs call for receptacles, combination devices, portable, tamper-resistant, weather-resistant, RoHS-compliant, NAFTA-compliant, hospital grade, audible alarm, or specification grade — there's a reliable P&S GFCI innovation for you.

- A. Self-Test GFCI with SafeLock® Protection** – conducts an automatic test every three seconds, ensuring it's always ready to protect. If the device fails the test, the indicator light flashes to signal that the GFCI should be replaced. If critical components are damaged and protection is lost, power to the receptacle is disconnected.
- B. Auto-Ground clip** assures a positive ground to metal box.
- C. Ground terminal back-wire clamp** for fast installation.
- D. Indicator light** makes it easy to identify status.
- E. Tamper-Resistant: Automatic shutter system** prevents young children from inserting common objects such as hairpins or keys.
- F. Two back-wire holes per termination** add wiring flexibility, eliminate pigtail, and save box space.
- G. Side or internal screw-pressure plate back-wire termination** speeds installation; takes #14 - #10 AWG stranded or solid, copper or copper-clad conductors.
- **Thinner than competitors' GFCI:** leaves more room for wires in the box.
- **Prevents line-load miswire:** No power to the face or downstream receptacles if wired incorrectly.
- **High-impact-resistant, thermoplastic construction** for superior strength and durability.
- **The most durable GFCI receptacle available** – Exceeds UL943 voltage surge requirements.
- **Feed-thru wiring configuration** allows GFCI to protect downstream receptacles.
- **FSUL Listed** (Federal Specification WC596).

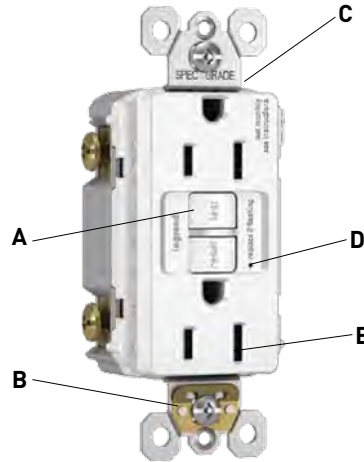

1597TRW

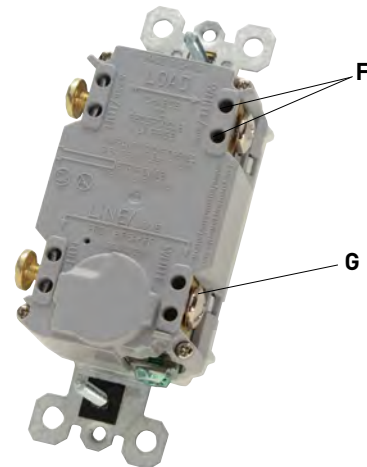

The radiant® collection is a step up from the standard with simple, classic options in wiring devices, home automation controls, and screwless wall plates that complement today's homes and hospitality settings.

GFCIs

the radiant[®] collection

radiant[®] Tamper-Resistant Self-Test GFCI Receptacles with SafeLock[®] Protection 2 Pole, 3 Wire Grounding 15 & 20A, 125VAC

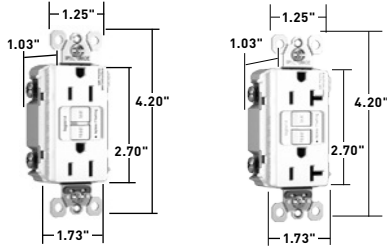

1597TRW

2097TRW

The radiant[®] collection is a step up from the standard with simple, classic options in wiring devices, home automation controls, and screwless wall plates that complement today's homes and hospitality settings.

Features

- Part of the radiant[®] collection of wiring devices, wall plates and home systems.
- Protects children: patented shutter system helps prevent improper insertion of foreign objects.
- Meets National Electrical Code[®] Tamper-Resistant requirements.
- Conducts an automatic test every three seconds, ensuring it's always ready to protect. If the device fails the test, the indicator light flashes to signal that the GFCI should be replaced. It also has our proven SafeLock Protection feature: if critical components are damaged and protection is lost, power to the receptacle is disconnected.
- Thinner than competitors' GFCI Receptacles: leaves more room for wires in the box.
- Auto-Ground clip assures a positive ground to metal box.
- Feed-thru wiring configuration allows GFCI to protect downstream receptacles.
- Prevents line-load reversal miswire: no power to the face or downstream receptacles if wired incorrectly.
- Exceeds UL943 voltage surge requirements.
- FSUL Listed (Federal Specification WC596).
- Trip indicator light (red LED).
- Side or internal screw-pressure-plate back wire with #10 – #14 AWG solid or stranded copper wire.
- Two back wire holes per terminal.
- Ground screw has a back wire clamp for easy installation.
- 10kA short circuit rating.
- Mounting screws are shipped captive in the device and wall plate for easier installation.
- High-impact-resistant thermoplastic construction.
- Extra-long strap.
- Button colors match the device face.
- Dual-direction test and reset buttons.
- Supplied with matching TP26 nylon wall plate (except NI and DB models).
- Tri-drive screws.

Specifications

- Supply Voltage: 125VAC, 60 Hz
- Supply Voltage Range: 102-132 VAC
- Trio Threshold: 5± 1mA
- Trip Time: 0.025 sec., nominal per UL Standard
- 20 Amp feed-thru capacity

CATALOG NUMBER	RATING		COLOR	NEMA CONFIG. NO.	3rd PARTY COMPLIANCE		
	A.	VAC			UL943 C22.2 No. 144	UL498 C22.2 No. 42	FSUL WC596
RADIANT[®] SPEC GRADE TAMPER-RESISTANT 15 AMP DUPLEX GFCI							
1597TRI	15	125	Ivory	5-15R	•	•	•
1597TRW	15	125	White	5-15R	•	•	•
1597TR	15	125	Brown	5-15R	•	•	•
1597TRBK	15	125	Black	5-15R	•	•	•
1597TRLA	15	125	Light Almond	5-15R	•	•	•
1597TRNICC4	15	125	Nickel	5-15R	•	•	•
1597TRDBCC4	15	125	Dark Bronze	5-15R	•	•	•
RADIANT[®] SPECIFICATION GRADE TAMPER-RESISTANT 20 AMP DUPLEX GFCI							
2097TRI	20	125	Ivory	5-20R	•	•	•
2097TRW	20	125	White	5-20R	•	•	•
2097TR	20	125	Brown	5-20R	•	•	•
2097TRGRY	20	125	Gray	5-20R	•	•	•
2097TRBK	20	125	Black	5-20R	•	•	•
2097TRRED	20	125	Red	5-20R	•	•	•
2097TRLA	20	125	Light Almond	5-20R	•	•	•

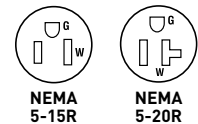

GFCIs

Hospital Grade Tamper-Resistant Self-Test GFCI Receptacles with SafeLock® Protection 2 Pole, 3 Wire Grounding 15 & 20A, 125VAC

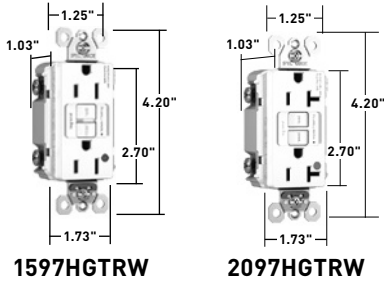

Features

- Protects children: patented shutter system helps prevent improper insertion of foreign objects.
- Meets National Electrical Code® Tamper-Resistant requirements.
- Conducts an automatic test every three seconds, ensuring it's always ready to protect. If the device fails the test, the indicator light flashes to signal that the GFCI should be replaced. It also has our proven SafeLock Protection feature: if critical components are damaged and protection is lost, power to the receptacle is disconnected.
- Thinner than competitors' GFCI Receptacles: leaves more room for wires in the box.
- Auto-Ground clip assures a positive ground to metal box.
- Feed-thru wiring configuration allows GFCI to protect downstream receptacles.
- Prevents line-load reversal miswire: no power to the face or downstream receptacles if wired incorrectly.
- Exceeds UL943 voltage surge requirements.
- FSUL Listed (Federal Specification WC596).
- Trip indicator light (red LED).
- Side or internal screw-pressure-plate back wire with #10 – #14 AWG solid or stranded copper wire.
- Two back wire holes per terminal.
- Ground screw has a back wire clamp for easy installation.
- 10kA short circuit rating.
- Mounting screws are shipped captive in the device and wall plate for easier installation.
- High-impact-resistant thermoplastic construction.
- Extra-long strap.
- Button colors match the device face.
- Dual-direction test and reset buttons.
- Class A rated GFCI.
- Supplied with matching TP26 nylon wall plate.
- Tri-drive screws.

Specifications

- Supply Voltage: 125VAC, 60 Hz
- Supply Voltage Range: 102-132 VAC
- Trio Threshold: 5± 1mA
- Trip Time: 0.025 sec., nominal per UL Standard
- 20 Amp feed-thru capacity

CATALOG NUMBER	RATING		COLOR	NEMA CONFIG. NO.	3rd PARTY COMPLIANCE		
	A.	VAC			UL943 C22.2 No. 144	UL498 C22.2 No. 42	FSUL WC596
HOSPITAL GRADE TAMPER-RESISTANT 15 AMP DUPLEX GFCI							
1597HGTRI	15	125	Ivory	5-15R	•	•	•
1597HGTRW	15	125	White	5-15R	•	•	•
1597HGTR	15	125	Brown	5-15R	•	•	•
1597HGTRBK	15	125	Black	5-15R	•	•	•
1597HGTRGRY	15	125	Gray	5-15R	•	•	•
1597HGTRRED	15	125	Red	5-15R	•	•	•
1597HGTRLA	15	125	Light Almond	5-15R	•	•	•
HOSPITAL GRADE TAMPER-RESISTANT 20 AMP DUPLEX GFCI							
2097HGTRI	20	125	Ivory	5-20R	•	•	•
2097HGTRW	20	125	White	5-20R	•	•	•
2097HGTR	20	125	Brown	5-20R	•	•	•
2097HGTRBK	20	125	Black	5-20R	•	•	•
2097HGTRGRY	20	125	Gray	5-20R	•	•	•
2097HGTRRED	20	125	Red	5-20R	•	•	•
2097HGTRLA	20	125	Light Almond	5-20R	•	•	•

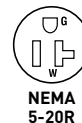

GFCIs

the radiant[®] collection

radiant[®] Specification Grade Self-Test GFCI Receptacles with SafeLock[®] Protection

2 Pole, 3 Wire Grounding 15 & 20A, 125VAC

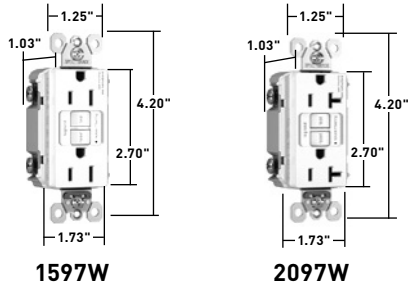

The radiant[®] collection is a step up from the standard with simple, classic options in wiring devices, home automation controls, and screwless wall plates that complement today's homes and hospitality settings.

Features

- Part of the radiant[®] collection of wiring devices, wall plates and home systems.
- Conducts an automatic test every three seconds, ensuring it's always ready to protect. If the device fails the test, the indicator light flashes to signal that the GFCI should be replaced. It also has our proven SafeLock Protection feature: if critical components are damaged and protection is lost, power to the receptacle is disconnected.
- Thinner than competitors' GFCI Receptacles: leaves more room for wires in the box.
- Auto-Ground clip assures a positive ground to metal box.
- Feed-thru wiring configuration allows GFCI to protect downstream receptacles.
- Prevents line-load reversal miswire: no power to the face or downstream receptacles if wired incorrectly.
- Exceeds UL943 voltage surge requirements.
- FSUL Listed (Federal Specification WC596).
- Trip indicator light (red LED).
- Side or internal screw-pressure-plate back wire with #10 – #14 AWG solid or stranded copper wire.
- Two back wire holes per terminal.
- Ground screw has a back wire clamp for easy installation.
- 10kA short circuit rating.
- Mounting screws are shipped captive in the device and wall plate for easier installation.
- High-impact-resistant thermoplastic construction.
- Extra-long strap.
- Button colors match the device face.
- Dual-direction test and reset buttons.
- Class A rated GFCI.
- Supplied with matching TP26 nylon wall plate.
- Tri-drive screws.

Specifications

- Supply Voltage: 125VAC, 60 Hz
- Supply Voltage Range: 102-132 VAC
- Trip Threshold: 5± 1mA
- Trip Time: 0.025 sec., nominal per UL Standard
- 20 Amp feed-thru capacity

CATALOG NUMBER	RATING		COLOR	NEMA CONFIG. NO.	3rd PARTY COMPLIANCE		
	A.	VAC			cUL ^{us} UL943 C22.2 No. 144	cUL ^{us} UL498 C22.2 No. 42	FSUL WC596
RADIANT[®] SPEC GRADE 15 AMP DUPLEX GFCI							
1597I	15	125	Ivory	5-15R	•	•	•
1597W	15	125	White	5-15R	•	•	•
1597	15	125	Brown	5-15R	•	•	•
1597GRY	15	125	Gray	5-15R	•	•	•
1597BK	15	125	Black	5-15R	•	•	•
1597RED	15	125	Red	5-15R	•	•	•
1597LA	15	125	Light Almond	5-15R	•	•	•
RADIANT[®] SPECIFICATION GRADE 20 AMP DUPLEX GFCI							
2097I	20	125	Ivory	5-20R	•	•	•
2097W	20	125	White	5-20R	•	•	•
2097	20	125	Brown	5-20R	•	•	•
2097GRY	20	125	Gray	5-20R	•	•	•
2097BK	20	125	Black	5-20R	•	•	•
2097RED	20	125	Red	5-20R	•	•	•
2097LA	20	125	Light Almond	5-20R	•	•	•

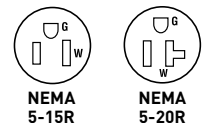

All devices listed on this page conform to NEMA WD-1 and WD-6.

GFCIs

Hospital Grade Self-Test GFCI Receptacles with SafeLock® Protection 2 Pole, 3 Wire Grounding 15 & 20A, 125VAC

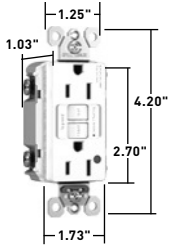

1597HGW

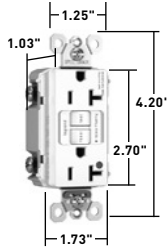

2097HGW

Features

- Conducts an automatic test every three seconds, ensuring it's always ready to protect. If the device fails the test, the indicator light flashes to signal that the GFCI should be replaced. It also has our proven SafeLock Protection feature: if critical components are damaged and protection is lost, power to the receptacle is disconnected.
- Thinner than competitors' GFCI Receptacles: leaves more room for wires in the box.
- Auto-Ground clip assures a positive ground to metal box.
- Feed-thru wiring configuration allows GFCI to protect downstream receptacles.
- Prevents line-load reversal miswire: no power to the face or downstream receptacles if wired incorrectly.
- Exceeds UL943 voltage surge requirements.
- FSUL Listed (Federal Specification WC596).
- Trip indicator light (red LED).
- Side or internal screw-pressure-plate back wire with #10 – #14 AWG solid or stranded copper wire.
- Two back wire holes per terminal.
- Ground screw has a back wire clamp for easy installation.
- 10kA short circuit rating.
- Mounting screws are shipped captive in the device and wall plate for easier installation.
- High-impact-resistant thermoplastic construction.
- Extra-long strap.
- Button colors match the device face.
- Dual-direction test and reset buttons.
- Class A rated GFCI.
- Supplied with matching TP26 nylon wall plate.
- Tri-drive screws.

Specifications

- Supply Voltage: 125VAC, 60 Hz
- Supply Voltage Range: 102-132 VAC
- Trip Threshold: 5± 1mA
- Trip Time: 0.025 sec., nominal per UL Standard
- 20 Amp feed-thru capacity

CATALOG NUMBER	RATING		COLOR	NEMA CONFIG. NO.	3rd PARTY COMPLIANCE		
	A.	VAC			UL943 C22.2 No. 144	UL498 C22.2 No. 42	FSUL WC596
HOSPITAL GRADE 15 AMP DUPLEX GFCI							
1597HGI	15	125	Ivory	5-15R	•	•	•
1597HGW	15	125	White	5-15R	•	•	•
1597HGBK	15	125	Black	5-15R	•	•	•
1597HGGRY	15	125	Gray	5-15R	•	•	•
1597HGRED	15	125	Red	5-15R	•	•	•
1597HGLA	15	125	Light Almond	5-15R	•	•	•
HOSPITAL GRADE 20 AMP DUPLEX GFCI							
2097HGI	20	125	Ivory	5-20R	•	•	•
2097HGW	20	125	White	5-20R	•	•	•
2097HG	20	125	Brown	5-20R	•	•	•
2097HGBK	20	125	Black	5-20R	•	•	•
2097HGGRY	20	125	Gray	5-20R	•	•	•
2097HGRED	20	125	Red	5-20R	•	•	•
2097HGLA	20	125	Light Almond	5-20R	•	•	•

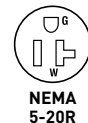
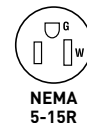

GFCIs

the radiant[®]
collection

radiant[®] Dead Front Self-Test GFCI Receptacles with SafeLock[®] Protection

20A, 125VAC

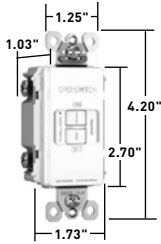

2087W

The radiant[®] collection is a step up from the standard with simple, classic options in wiring devices, home automation controls, and screwless wall plates that complement today's homes and hospitality settings.

Features

- Part of the radiant[®] collection of wiring devices, wall plates and home systems.
- Rated as a 1 1/2 HP motor control switch.
- Conducts an automatic test every three seconds, ensuring it's always ready to protect. If the device fails the test, the indicator light flashes to signal that the GFCI should be replaced. It also has our proven SafeLock Protection feature: if critical components are damaged and protection is lost, power to the downstream load is disconnected.
- Thinner than competitors' Dead Front GFCI: leaves more room for wires in the box.
- Auto-Ground clip assures a positive ground to metal box.
- Feed-thru wiring configuration allows GFCI to protect downstream receptacles.
- Prevents line-load reversal miswire: no power to the face or downstream receptacles if wired incorrectly.
- Exceeds UL943 voltage surge requirements.
- Trip indicator light (red LED).
- Side or internal screw-pressure-plate back wire with #10 – #14 AWG solid or stranded copper wire.
- Two back wire holes per terminal.
- Ground screw has a back wire clamp for easy installation.
- 10kA short circuit rating.
- Mounting screws are shipped captive in the device and wall plate for easier installation.
- High-impact-resistant thermoplastic construction.
- Extra-long strap.
- Button colors match the device face.
- Dual-direction test and reset buttons.
- Class A rated GFCI.
- Supplied with matching TP26 nylon wall plate.
- Tri-drive screws.

Specifications

- Supply Voltage: 125VAC, 60 Hz
- Supply Voltage Range: 102-132 VAC
- Trio Threshold: 5± 1mA
- Trip Time: 0.025 sec., nominal per UL Standard
- 20 Amp feed-thru capacity

CATALOG NUMBER	RATING		COLOR	3rd PARTY COMPLIANCE	
	A.	VAC		UL943 C22.2 No. 144	UL498 C22.2 No. 42
RADIANT[®] SPECIFICATION GRADE DEAD FRONT GFCI – 1 1/2 HP MOTOR CONTROL RATING					
2087I	20	125	Ivory	•	•
2087W	20	125	White	•	•
2087BK	20	125	Black	•	•
2087LA	20	125	Light Almond	•	•

GFCIs

radiant® Tamper-Resistant Self-Test Switch / GFCI Receptacles with SafeLock® Protection 15A, 125VAC

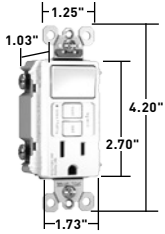

1597SWTTRWCC4

The radiant® collection is a step up from the standard with simple, classic options in wiring devices, home automation controls, and screwless wall plates that complement today's homes and hospitality settings.

Features

- Part of the radiant® collection of wiring devices, wall plates and home systems.
- Protects children: patented shutter system helps prevent improper insertion of foreign objects.
- Meets National Electrical Code® Tamper-Resistant requirements.
- Conducts an automatic test every three seconds, ensuring it's always ready to protect. If the device fails the test, the indicator light flashes to signal that the GFCI should be replaced. It also has our proven SafeLock Protection feature: if critical components are damaged and protection is lost, power to the receptacle is disconnected.
- Thinner than competitors' GFCI Receptacles: leaves more room for wires in the box.
- Auto-Ground clip assures a positive ground to metal box.
- Feed-thru wiring configuration allows GFCI to protect downstream receptacles.
- Prevents line-load reversal miswire: no power to the face or downstream receptacles if wired incorrectly.
- Exceeds UL943 voltage surge requirements.
- Trip indicator light (red LED).
- Two back wire holes per terminal.
- Side or internal screw-pressure-plate back wire with #10 – #14 AWG solid or stranded copper wire.
- Ground screw has a back wire clamp for easy installation.
- 10kA short circuit rating.
- Mounting screws are shipped captive in the device and wall plate for easier installation.
- High-impact-resistant thermoplastic construction.
- Extra-long strap.
- Button colors match the device face.
- Dual-direction test and reset buttons.
- Class A rated GFCI.
- Supplied with matching TP26 nylon wall plate.
- Tri-drive screws.

Specifications

- Supply Voltage: 125VAC, 60 Hz
- Supply Voltage Range: 102-132 VAC
- Trip Threshold: 5± 1mA
- Trip Time: 0.025 sec., nominal per UL Standard
- 20 Amp feed-thru capacity

CATALOG NUMBER	SWITCH RATING		RECEPTACLE RATING		COLOR	NEMA CONFIG. NO.	3rd PARTY COMPLIANCE		
	A.	VAC	A.	VAC			UL943 C22.2 No. 144	UL498 C22.2 No. 42	UL943 C22.2 No. 144
RADIANT® COMBINATION TAMPER-RESISTANT SINGLE POLE SWITCH/GFCI									
1597SWTTRICC4	15	120	15	125	Ivory	5-15R	•	•	•
1597SWTTRWCC4	15	120	15	125	White	5-15R	•	•	•
1597SWTTRBKCC4	15	120	15	125	Black	5-15R	•	•	•
1597SWTTRLACC4	15	120	15	125	Light Almond	5-15R	•	•	•

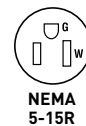

GFCIs

the radiant[®] collection

radiant[®] and Hospital Grade Tamper-Resistant Self-Test Night Light/GFCI Receptacles with SafeLock[®] Protection 2 Pole, 3 Wire Grounding 15 & 20A, 125VAC

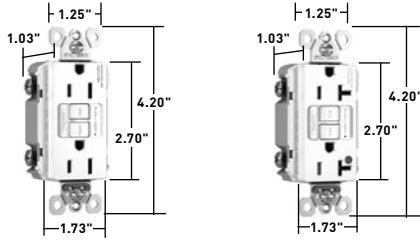

1597NLTTRWCC4 2097HGNTLTRW

The radiant[®] collection is a step up from the standard with simple, classic options in wiring devices, home automation controls, and screwless wall plates that complement today's homes and hospitality settings.

Features

- Part of the radiant[®] collection of wiring devices, wall plates and home systems.
- Protects children: patented shutter system helps prevent improper insertion of foreign objects.
- Meets National Electrical Code[®] Tamper-Resistant requirements.
- Conducts an automatic test every three seconds, ensuring it's always ready to protect. If the device fails the test, the indicator light flashes to signal that the GFCI should be replaced. It also has our proven SafeLock Protection feature: if critical components are damaged and protection is lost, power to the receptacle is disconnected.
- Thinner than competitors' GFCI Receptacles: leaves more room for wires in the box.
- Auto-Ground clip assures a positive ground to metal box.
- Sealed night light with high impact-resistant Lexan[®] lens prevents tampering.
- Night light uses cooler LED illumination.
- Energy-efficient LED has average 20-year life expectancy, eliminating bulb replacement.
- LED Rated at 186 milliwatts @ 120V.
- Photocell turns night light ON in dark, OFF in daylight.
- Two receptacles.
- Feed-thru wiring configuration allows GFCI to protect downstream receptacles.
- Prevents line-load reversal miswire: no power to the face or downstream receptacles if wired incorrectly.
- Exceeds UL943 voltage surge requirements.
- FSUL Listed (Federal Specification WC596).
- Trip indicator light (red LED).
- Side or internal screw-pressure-plate back wire with #10 – #14 AWG solid or stranded copper wire.
- Two back wire holes per terminal.
- Ground screw has a back wire clamp for easy installation.
- 10kA short circuit rating.
- Mounting screws are shipped captive in the device and wall plate for easier installation.
- High-impact-resistant thermoplastic construction.
- Extra-long strap.
- Button colors match the device face.
- Dual-direction test and reset buttons.
- Class A rated GFCI.
- Supplied with matching TP26 nylon wall plate (except 1597NLTTRNICC4 and 1597NLTTRDBCC4).

Specifications

- Supply Voltage: 125VAC, 60 Hz
- Supply Voltage Range: 102-132 VAC
- Trio Threshold: 5± 1mA
- Trip Time: 0.025 sec., nominal per UL Standard
- 20 Amp feed-thru capacity

CATALOG NUMBER	RATING		LIGHT OUTPUT IN 1' FCD*	COLOR	NEMA CONFIG. NO.	3rd PARTY COMPLIANCE		
	A.	VAC				UL943 C22.2 No. 144	UL498 C22.2 No. 42	FSUL WC596
RADIANT[®] COMBINATION TAMPER-RESISTANT 15 AMP NIGHT LIGHT/GFCI								
1597NLTTRI	15	125	0.10	Ivory	5-15R	•	•	•
1597NLTTRW	15	125	0.10	White	5-15R	•	•	•
1597NLTTRBKCC4	15	125	0.10	Black	5-15R	•	•	•
1597NLTTRLA	15	125	0.10	Light Almond	5-15R	•	•	•
1597NLTTRNICC4	15	125	0.10	Nickel	5-15R	•	•	•
1597NLTTRDBCC4	15	125	0.10	Dark Bronze	5-15R	•	•	•
RADIANT[®] COMBINATION TAMPER-RESISTANT 20 AMP NIGHT LIGHT/GFCI								
2097NLTTRI	20	125	0.10	Ivory	5-20R	•	•	•
2097NLTTRW	20	125	0.10	White	5-20R	•	•	•
2097NLTTRGRY	20	125	0.10	Gray	5-20R	•	•	•
2097NLTTRLA	20	125	0.10	Light Almond	5-20R	•	•	•
HOSPITAL GRADE COMBINATION TAMPER-RESISTANT 20 AMP NIGHT LIGHT/GFCI								
2097HGNTLTRI	20	125	0.10	Ivory	5-20R	•	•	•
2097HGNTLTRW	20	125	0.10	White	5-20R	•	•	•
2097HGNTLTRGRY	20	125	0.10	Gray	5-20R	•	•	•
2097HGNTLTRRED	20	125	0.10	Red	5-20R	•	•	•
2097HGNTLTRLA	20	125	0.10	Light Almond	5-20R	•	•	•

*FCD = Foot Candle Distance, 1 Lumen = 1 FCD. See Page U-68 for more information.

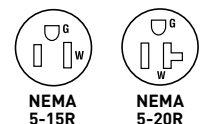

All devices listed on this page conform to NEMA WD-1 and WD-6.

GFCIs

radiant® Weather-Resistant Self-Test GFCI Receptacles with SafeLock® Protection

2 Pole, 3 Wire Grounding 15 & 20A, 125VAC

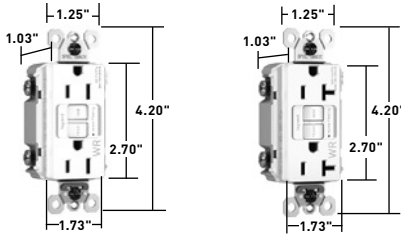

1597TRWRW

2097TRWRW

The radiant® collection is a step up from the standard with simple, classic options in wiring devices, home automation controls, and screwless wall plates that complement today's homes and hospitality settings.

Features

- Part of the radiant® collection of wiring devices, wall plates and home systems.
- Weather-Resistant: Meets National Electrical Code® Weather-Resistant requirements.
- Tamper-Resistant: Meets National Electrical Code® Tamper-Resistant requirements.
- Protects children: patented shutter system helps prevent improper insertion of foreign objects.
- Listed to the Weather-Resistant supplement of UL498 meeting demanding UL requirements including:
 - Ultraviolet light exposure test
 - Cold impact test
 - Accelerated aging test
 - Stringent material requirements for current carrying parts, wire binding screws and mounting straps to ensure superior corrosion resistance.
- Conducts an automatic test every three seconds, ensuring it's always ready to protect. If the device fails the test, the indicator light flashes to signal that the GFCI should be replaced. It also has our proven SafeLock Protection feature: if critical components are damaged and protection is lost, power to the receptacle is disconnected.
- Thinner than competitors' GFCI Receptacles: leaves more room for wires in the box.
- Auto-Ground clip assures a positive ground to metal box.
- Feed-thru wiring configuration allows GFCI to protect downstream receptacles.
- Prevents line-load reversal miswire: no power to the face or downstream receptacles if wired incorrectly.
- Exceeds UL943 voltage surge requirements.
- FSUL Listed (Federal Specification WC596).
- Trip indicator light (red LED)
- Side or internal screw-pressure-plate back wire with #10 – #14 AWG solid or stranded copper wire.
- Two back wire holes per terminal.
- Ground screw has a back wire clamp for easy installation.
- 10kA short circuit rating.
- Mounting screws are shipped captive in the device and wall plate for easier installation.
- High-impact-resistant thermoplastic construction.
- Extra-long nickel post-plated steel mounting strap.
- Button colors match the device face.
- Dual-direction test and reset buttons.
- Class A rated GFCI.
- Supplied with matching TP26 nylon wall plate.
- Tri-drive screws.

Specifications

- Supply Voltage: 125VAC, 60 Hz
- Supply Voltage Range: 102-132 VAC
- Trio Threshold: 5± 1mA
- Trip Time: 0.025 sec., nominal per UL Standard
- 20 Amp feed-thru capacity

CATALOG NUMBER	RATING		COLOR	NEMA CONFIG. NO.	3rd PARTY COMPLIANCE		
	A.	VAC			UL943 C22.2 No. 144	UL498 C22.2 No. 42	FSUL WC596
RADIANT® SPEC GRADE WEATHER-RESISTANT 15 AMP DUPLEX GFCI							
1597TRWRI	15	125	Ivory	5-15R	•	•	•
1597TRWRW	15	125	White	5-15R	•	•	•
1597TRWR	15	125	Brown	5-15R	•	•	•
1597TRWRGRY	15	125	Gray	5-15R	•	•	•
1597TRWRBK	15	125	Black	5-15R	•	•	•
1597TRWRLA	15	125	Light Almond	5-15R	•	•	•
RADIANT® SPECIFICATION GRADE WEATHER-RESISTANT 20 AMP DUPLEX GFCI							
2097TRWRI	20	125	Ivory	5-20R	•	•	•
2097TRWRW	20	125	White	5-20R	•	•	•
2097TRWR	20	125	Brown	5-20R	•	•	•
2097TRWRGRY	20	125	Gray	5-20R	•	•	•
2097TRWRBK	20	125	Black	5-20R	•	•	•
2097TRWRLA	20	125	Light Almond	5-20R	•	•	•

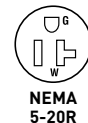

GFCIs

the radiant[®] collection

radiant[®] and Hospital Grade Audible Alarm Self-Test GFCI Receptacles with SafeLock[®] Protection 2 Pole, 3 Wire Grounding 15 & 20A, 125VAC

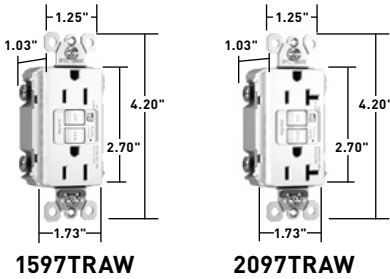

The radiant[®] collection is a step up from the standard with simple, classic options in wiring devices, home automation controls, and screwless wall plates that complement today's homes and hospitality settings.

Features

- Part of the radiant[®] collection of wiring devices, wall plates and home systems.
- Audible Alarm alert of tripped condition. Alarm can be turned ON/OFF.
- Alarm rated at 60 db at 10 feet.
- Rated as a 1.5 HP motor control switch.
- Protects children: patented shutter system helps prevent improper insertion of foreign objects.
- Meets National Electrical Code[®] Tamper-Resistant requirements.
- Conducts an automatic test every three seconds, ensuring it's always ready to protect. If the device fails the test, the indicator light flashes to signal that the GFCI should be replaced. It also has our proven SafeLock Protection feature: if critical components are damaged and protection is lost, power to the receptacle is disconnected.
- Thinner than competitors' GFCI Receptacles: leaves more room for wires in the box.
- Auto-Ground clip assures a positive ground to metal box.
- Feed-thru wiring configuration allows GFCI to protect downstream receptacles.
- Prevents line-load reversal miswire: no power to the face or downstream receptacles if wired incorrectly.
- Exceeds UL943 voltage surge requirements.
- FSUL Listed (Federal Specification WC596).
- Trip indicator light (red LED).
- Side or internal screw-pressure-plate back wire with #10 - #14 AWG solid or stranded copper wire.
- Two back wire holes per terminal.
- Ground screw has a back wire clamp for easy installation.
- 10kA short circuit rating.
- Mounting screws are shipped captive in the device and wall plate for easier installation.
- High-impact-resistant thermoplastic construction.
- Extra-long strap.
- Button colors match the device face.
- Dual-direction test and reset buttons.
- Supplied with matching TP26 nylon wall plate.
- Tri-drive screws.

Specifications

- Supply Voltage: 125VAC, 60 Hz
- Supply Voltage Range: 102-132 VAC
- Trio Threshold: 5± 1mA
- Trip Time: 0.025 sec., nominal per UL Standard
- 20 Amp feed-thru capacity

CATALOG NUMBER	RATING		COLOR	NEMA CONFIG. NO.	3rd PARTY COMPLIANCE		
	A.	VAC			UL943 C22.2 No. 144	UL498 C22.2 No. 42	FSUL WC596
RADIANT[®] AUDIBLE ALARM TAMPER-RESISTANT DUPLEX GFCI							
1597TRAI	15	125	Ivory	5-15R	•	•	•
1597TRAW	15	125	White	5-15R	•	•	•
1597TRA	15	125	Brown	5-15R	•	•	•
1597TRALA	15	125	Light Almond	5-15R	•	•	•
RADIANT[®] SPECIFICATION GRADE AUDIBLE ALARM TAMPER-RESISTANT DUPLEX GFCI							
2097TRAI	20	125	Ivory	5-20R	•	•	•
2097TRAW	20	125	White	5-20R	•	•	•
2097TRA	20	125	Brown	5-20R	•	•	•
2097TRALA	20	125	Light Almond	5-20R	•	•	•
HOSPITAL GRADE AUDIBLE ALARM TAMPER-RESISTANT DUPLEX GFCI							
1597HGTRA	15	125	Brown	5-15R	•	•	•
1597HGTRALA	15	125	Light Almond	5-15R	•	•	•
2097HGTRAI	20	125	Ivory	5-20R	•	•	•
2097HGTRAW	20	125	White	5-20R	•	•	•
2097HGTRARED	20	125	Red	5-20R	•	•	•
2097HGTRALA	20	125	Light Almond	5-20R	•	•	•

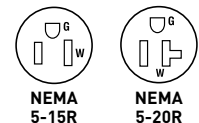

GFCIs

radiant® and Hospital Grade Isolated-Ground Self-Test GFCI Receptacles with SafeLock® Protection 2 Pole, 3 Wire Grounding 15 & 20A, 125VAC

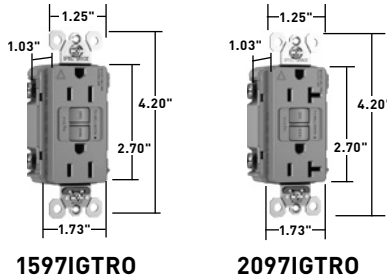

The radiant® collection is a step up from the standard with simple, classic options in wiring devices, home automation controls, and screwless wall plates that complement today's homes and hospitality settings.

Features

- Part of the radiant® collection of wiring devices, wall plates and home systems.
- GFCI receptacle's grounding system is isolated from the building's grounding system.
- Protects children: patented shutter system helps prevent improper insertion of foreign objects.
- Meets National Electrical Code® Tamper-Resistant requirements.
- Conducts an automatic test every three seconds, ensuring it's always ready to protect. If the device fails the test, the indicator light flashes to signal that the GFCI should be replaced. It also has our proven SafeLock Protection feature: if critical components are damaged and protection is lost, power to the receptacle is disconnected.
- Thinner than competitors' GFCI Receptacles: leaves more room for wires in the box.
- Auto-Ground clip assures a positive ground to metal box.
- Feed-thru wiring configuration allows GFCI to protect downstream receptacles.
- Prevents line-load reversal miswire: no power to the face or downstream receptacles if wired incorrectly.
- Pre-stripped stranded wire lead for isolated ground termination.
- Exceeds UL943 voltage surge requirements.
- FSUL Listed (Federal Specification WC596).
- Trip indicator light (red LED).
- Side or internal screw-pressure-plate back wire with #10 – #14 AWG solid or stranded copper wire.
- Two back wire holes per terminal.
- Ground screw has a back wire clamp for easy installation.
- 10kA short circuit rating.
- Mounting screws are shipped captive in the device and wall plate for easier installation.
- High-impact-resistant thermoplastic construction.
- Extra-long strap.
- Button colors match the device face.
- Dual-direction test and reset buttons.
- Supplied with matching TP26 nylon wall plate.
- Tri-drive screws.

Specifications

- Supply Voltage: 125VAC, 60 Hz
- Supply Voltage Range: 102-132 VAC
- Trip Threshold: 5± 1mA
- Trip Time: 0.025 sec., nominal per UL Standard
- 20 Amp feed-thru capacity

CATALOG NUMBER	RATING		COLOR	NEMA CONFIG. NO.	3rd PARTY COMPLIANCE		
	A.	VAC			UL943 C22.2 No. 144	UL498 C22.2 No. 42	FSUL WC596
RADIANT® ISOLATED GROUND TAMPER-RESISTANT DUPLEX GFCI							
1597IGTRI	15	125	Ivory	5-15R	•	•	•
1597IGTRW	15	125	White	5-15R	•	•	•
1597IGTRLA	15	125	Light Almond	5-15R	•	•	•
1597IGTROCC4	15	125	Orange	5-15R	•	•	•
SPECIFICATION GRADE ISOLATED GROUND TAMPER-RESISTANT DUPLEX GFCI							
2097IGTRI	20	125	Ivory	5-20R	•	•	•
2097IGTRW	20	125	White	5-20R	•	•	•
2097IGTRGRY	20	125	Gray	5-20R	•	•	•
2097IGTRO	20	125	Orange	5-20R	•	•	•
2097IGTRLA	20	125	Light Almond	5-20R	•	•	•
HOSPITAL GRADE ISOLATED GROUND TAMPER-RESISTANT DUPLEX GFCI							
1597IGHGTRO	15	125	Orange	5-15R	•	•	•
2097IGHGTTRI	20	125	Ivory	5-20R	•	•	•
2097IGHGTTRW	20	125	White	5-20R	•	•	•
2097IGHGTTRRED	20	125	Red	5-20R	•	•	•
2097IGHGTRO	20	125	Orange	5-20R	•	•	•
2097IGHGTTRLA	20	125	Light Almond	5-20R	•	•	•

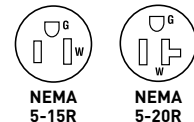

GFCIs

PlugTail® Self-Test GFCI Receptacles with SafeLock® Protection 2 Pole, 3 Wire Grounding 15 & 20A, 125VAC

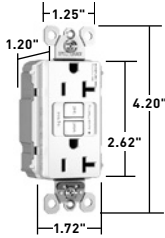

PT2097W

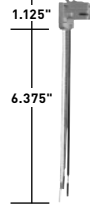

PTR6STR

Features

- Faster, more reliable installation.
- No exposed terminals create a finger safe application before, during, and after installation.
- Built-in connector features large brass terminal blades to ensure consistent, reliable electrical connections to PlugTail Connector.
- GFCI works with the existing 3-wire PlugTail Connectors creating a non-feed-thru application for facility owners.
- Conducts an automatic test every three seconds, ensuring it's always ready to protect. If the device fails the test, the indicator light flashes to signal that the

- GFCI should be replaced. It also has our proven SafeLock Protection feature: if critical components are damaged and protection is lost, power to the receptacle is disconnected.
- Thinner than competitors' GFCI Receptacles: leaves more room for wires in the box.
- Auto-Ground clip assures a positive ground to metal box.
- FSUL Listed (Federal Specification WC596).
- Exceeds UL 943 voltage surge requirements.

- Trip indicator light (red LED).
- 10kA short circuit rating.
- Mounting screws are shipped captive in the device and wall plate for easier installation.
- High-impact-resistant thermoplastic construction.
- Zinc-plated steel mounting strap.
- Button colors match the device face.
- Dual-direction test and reset buttons.
- Class A rated GFCI.
- Supplied with matching TP26 nylon wall plate.
- Tri-drive screws.

Specifications

- Supply Voltage: 125VAC, 60 Hz
- Supply Voltage Range: 102-132 VAC
- Trio Threshold: 5± 1mA
- Trip Time: 0.025 sec., nominal per UL Standard

CATALOG NUMBER	RATING		COLOR	NEMA CONFIG. NO.	3rd PARTY COMPLIANCE		
	A.	VAC			UL943 C22.2 No. 144	UL498 C22.2 No. 42	FSUL WC596
SPECIFICATION GRADE 15 AMP DUPLEX GFCI							
PT1597I	15	125	Ivory	5-15R	•	•	•
PT1597W	15	125	White	5-15R	•	•	•
PT1597GRY	15	125	Gray	5-15R	•	•	•
PT1597LA	15	125	Light Almond	5-15R	•	•	•
SPECIFICATION GRADE 20 AMP DUPLEX GFCI							
PT2097I	20	125	Ivory	5-20R	•	•	•
PT2097W	20	125	White	5-20R	•	•	•
PT2097	20	125	Brown	5-20R	•	•	•
PT2097GRY	20	125	Gray	5-20R	•	•	•
PT2097BKK	20	125	Black	5-20R	•	•	•
PT2097RED	20	125	Red	5-20R	•	•	•
PT2097LA	20	125	Light Almond	5-20R	•	•	•

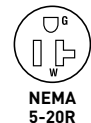
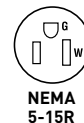

CATALOG NUMBER	WIRE TYPE	WIRE LENGTH
PLUGTAIL CONNECTORS – RIGHT ANGLE		
PTRA6STR	Stranded	6"
PTRA6SOL	Solid	6"

For additional PlugTail Connectors, see Page B-4.

All PlugTail Connectors are available in any wire length up to 25 inches, consult factory to order.

All devices listed on this page conform to NEMA WD-1 and WD-6.

GFCIs

PlugTail® Hospital Grade Self-Test GFCI Receptacles with SafeLock® Protection 2 Pole, 3 Wire Grounding 15 & 20A, 125VAC

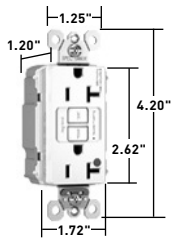

PT2097HGW

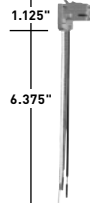

PTRA6STR

Features

- Faster, more reliable installation.
- No exposed terminals create a finger safe application before, during, and after installation.
- Built-in connector features large brass terminal blades to ensure consistent, reliable electrical connections to PlugTail Connector.
- GFCI works with the existing 3-wire PlugTail Connectors creating a non-feed-thru application for facility owners.
- Conducts an automatic test every three seconds, ensuring it's always ready to protect. If the device fails the test, the indicator light flashes to signal that the GFCI should be replaced. It also has our proven SafeLock Protection feature: if critical components are damaged and protection is lost, power to the receptacle is disconnected.
- Thinner than competitors' GFCI Receptacles: leaves more room for wires in the box.
- Auto-Ground clip assures a positive ground to metal box.
- 10kA short circuit rating.
- FSUL Listed (Federal Specification WC596).
- Exceeds UL 943 voltage surge requirements.
- Trip indicator light (red LED).
- Mounting screws are shipped captive in the device and wall plate for easier installation.
- High-impact-resistant thermoplastic construction.
- Zinc-plated steel mounting strap.
- Button colors match the device face.
- Dual-direction test and reset buttons.
- Class A rated GFCI.
- Supplied with matching TP26 nylon wall plate.
- Tri-drive screws.

Specifications

- Supply Voltage: 125VAC, 60 Hz
- Supply Voltage Range: 102-132 VAC
- Trio Threshold: 5± 1mA
- Trip Time: 0.025 sec., nominal per UL Standard

CATALOG NUMBER	RATING		COLOR	NEMA CONFIG. NO.	3rd PARTY COMPLIANCE		
	A.	VAC			UL943 C22.2 No. 144	UL498 C22.2 No. 42	FSUL WC596
HOSPITAL GRADE 15 AMP DUPLEX GFCI							
PT1597HGW	15	125	White	5-15R	•	•	•
PT1597HGRED	15	125	Red	5-15R	•	•	•
PT1597HGLA	15	125	Light Almond	5-15R	•	•	•
HOSPITAL GRADE 20 AMP DUPLEX GFCI							
PT2097HGI	20	125	Ivory	5-20R	•	•	•
PT2097HGW	20	125	White	5-20R	•	•	•
PT2097HG	20	125	Brown	5-20R	•	•	•
PT2097HGGRY	20	125	Gray	5-20R	•	•	•
PT2097HGBK	20	125	Black	5-20R	•	•	•
PT2097HGRED	20	125	Red	5-20R	•	•	•
PT2097HGLA	20	125	Light Almond	5-20R	•	•	•

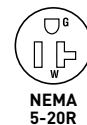
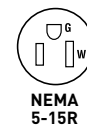

CATALOG NUMBER	WIRE TYPE	WIRE LENGTH
PLUGTAIL CONNECTORS – RIGHT ANGLE		
PTRA6STR	Stranded	6"
PTRA6SOL	Solid	6"

For additional PlugTail Connectors, see Page B-4.

All PlugTail Connectors are available in any wire length up to 25 inches, consult factory to order.

All devices listed on this page conform to NEMA WD-1 and WD-6.

GFCIs

PlugTail® Specification & Hospital Grade Tamper-Resistant Self-Test GFCI Receptacles with SafeLock® Protection 2 Pole, 3 Wire Grounding 15 & 20A, 125VAC

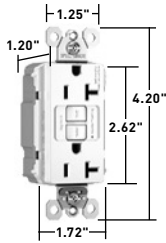

PT2097TRW

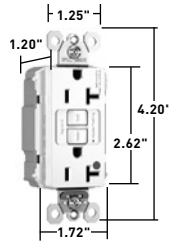

PT2097HGTRW

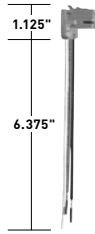

PTR6STR

Features

- Protects children: patented shutter system helps prevent improper insertion of foreign objects.
- Meets National Electrical Code® Tamper-Resistant requirements.
- Faster, more reliable installation.
- No exposed terminals create a finger safe application before, during, and after installation.
- Built-in connector features large brass terminal blades to ensure consistent, reliable electrical connections to PlugTail Connector.
- GFCI works with the existing 3-wire PlugTail Connectors creating a non-feed-thru application for facility owners.
- Conducts an automatic test every three seconds, ensuring it's always ready to protect. If the device fails the test, the indicator light flashes to signal that the GFCI should be replaced. It also has our proven SafeLock Protection feature: if critical components are damaged and protection is lost, power to the receptacle is disconnected.
- Thinner than competitors' GFCI Receptacles: leaves more room for wires in the box.
- Auto-Ground clip assures a positive ground to metal box.
- 10kA short circuit rating.
- FSUL Listed (Federal Specification WC596).
- Exceed UL 943 voltage surge requirements.
- Trip indicator light (red LED).
- Mounting screws are shipped captive in the device and wall plate for easier installation.
- High-impact-resistant thermoplastic construction.
- Zinc-plated steel mounting strap.
- Button colors match the device face.
- Dual-direction test and reset buttons.
- Class A rated GFCI.
- Supplied with matching TP26 nylon wall plate.
- Tri-drive screws.

CATALOG NUMBER	RATING		COLOR	NEMA CONFIG. NO.	3rd PARTY COMPLIANCE		
	A.	VAC			UL943 C22.2 No. 144	UL498 C22.2 No. 42	FSUL WC596
SPECIFICATION GRADE TAMPER-RESISTANT 15 AMP DUPLEX GFCI							
PT1597TRI	15	125	Ivory	5-15R	•	•	•
PT1597TRW	15	125	White	5-15R	•	•	•
PT1597TRGRY	15	125	Gray	5-15R	•	•	•
PT1597TRRED	15	125	Red	5-15R	•	•	•
PT1597TRLA	15	125	Light Almond	5-15R	•	•	•
SPECIFICATION GRADE TAMPER-RESISTANT 20 AMP DUPLEX GFCI							
PT2097TRI	20	125	Ivory	5-20R	•	•	•
PT2097TRW	20	125	White	5-20R	•	•	•
PT2097TR	20	125	Brown	5-20R	•	•	•
PT2097TRGRY	20	125	Gray	5-20R	•	•	•
PT2097TRRED	20	125	Red	5-20R	•	•	•
PT2097TRLA	20	125	Light Almond	5-20R	•	•	•
HOSPITAL GRADE TAMPER-RESISTANT 15 AMP DUPLEX GFCI							
PT1597HGTRI	15	125	Ivory	5-15R	•	•	•
PT1597HGTRW	15	125	White	5-15R	•	•	•
PT1597HGTRRED	15	125	Red	5-15R	•	•	•
PT1597HGTRLA	15	125	Light Almond	5-15R	•	•	•
HOSPITAL GRADE TAMPER-RESISTANT 15 AMP DUPLEX GFCI							
PT2097HGTRI	20	125	Ivory	5-20R	•	•	•
PT2097HGTRW	20	125	White	5-20R	•	•	•
PT2097HGTRGRY	20	125	Gray	5-20R	•	•	•
PT2097HGTRBK	20	125	Black	5-20R	•	•	•
PT2097HGTRRED	20	125	Red	5-20R	•	•	•
PT2097HGTRLA	20	125	Light Almond	5-20R	•	•	•

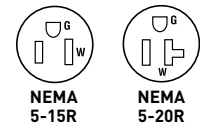

For PlugTail Connector catalog numbers, see Page C-13 or C-14.

All devices listed on this page conform to NEMA WD-1 and WD-6.

GFCIs

PlugTail® Specification & Hospital Grade Tamper-Resistant Self-Test Night Light/ GFCI Receptacles with SafeLock® Protection 2 Pole, 3 Wire Grounding 15 & 20A, 125VAC

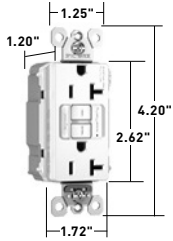

PT2097NLTTRW

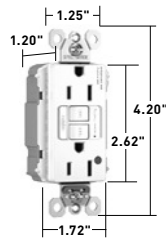

PT1597HGNTLTRI

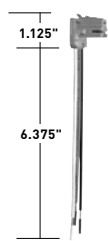

PTR6STR

Features

- Protects children: patented shutter system helps prevent improper insertion of foreign objects.
- Meets National Electrical Code® Tamper-Resistant requirements.
- Sealed night light with high impact-resistant Lexan® lens prevents tampering.
- Night light uses cooler LED illumination.
- Energy-efficient LED has average 20-year life expectancy, eliminating bulb replacement.
- Photocell turns night light ON in dark, OFF in daylight.
- Faster, more reliable installation.
- No exposed terminals create a finger safe application before, during, and after installation.
- Built-in connector features large brass terminal blades to ensure consistent, reliable electrical connections to PlugTail Connector.
- GFCI works with the existing 3-wire PlugTail Connectors creating a non-feed-thru application for facility owners. At rough-in just install the same right angle connector for GFCI and receptacle openings.
- Conducts an automatic test every three seconds, ensuring it's always ready to protect. If the device fails the test, the indicator light flashes to signal that the GFCI should be replaced. It also has our proven SafeLock Protection feature: if critical components are damaged and protection is lost, power to the receptacle is disconnected.
- Thinner than competitors' GFCI Receptacles: leaves more room for wires in the box.
- Auto-Ground clip assures a positive ground to metal box.
- Exceeds UL943 voltage surge requirements.
- 10kA short circuit rating.
- FSUL Listed (Federal Specification WC596).
- Trip indicator light (red LED).
- Mounting screws are shipped captive in the device and wall plate for easier installation.
- High-impact-resistant thermoplastic construction.
- Zinc-plated steel mounting strap.
- Button colors match the device face.
- Dual-direction test and reset buttons.
- Class A rated GFCI.
- Supplied with matching TP26 nylon wall plate.
- Tri-drive screws.

Specifications

- Supply Voltage: 125VAC, 60 Hz
- Supply Voltage Range: 102-132 VAC
- Trio Threshold: 5± 1mA
- Trip Time: 0.025 sec., nominal per UL Standard

CATALOG NUMBER	RATING		LIGHT OUTPUT IN 1' FCD*	COLOR	NEMA CONFIG. NO.	3rd PARTY COMPLIANCE		
	A.	VAC				UL943 C22.2 No. 144	UL498 C22.2 No. 42	FSUL WC596
SPECIFICATION GRADE TAMPER-RESISTANT 20 AMP COMBINATION NIGHT LIGHT/GFCI								
PT2097NLTTRI	20	125	0.10	Ivory	5-20R	•	•	•
PT2097NLTTRW	20	125	0.10	White	5-20R	•	•	•
HOSPITAL GRADE TAMPER-RESISTANT 15 AMP COMBINATION NIGHT LIGHT/GFCI								
PT1597HGNTLTRI	15	125	0.10	Ivory	5-15R	•	•	•
PT1597HGNTLTRRED	15	125	0.10	Red	5-15R	•	•	•
HOSPITAL GRADE TAMPER-RESISTANT 20 AMP COMBINATION NIGHT LIGHT/GFCI								
PT2097HGNTLTRI	20	125	0.10	Ivory	5-20R	•	•	•
PT2097HGNTLTRW	20	125	0.10	White	5-20R	•	•	•
PT2097HGNTLTRGRY	20	125	0.10	Gray	5-20R	•	•	•
PT2097HGNTLTRLA	20	125	0.10	Light Almond	5-20R	•	•	•

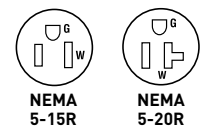

For PlugTail Connector catalog numbers, see Page C-13 or C-14.

GFCIs

the radiant[®] collection

radiant[®] NAFTA-Compliant Self-Test GFCI Receptacles with SafeLock[®] Protection 2 Pole, 3 Wire Grounding 15 & 20A, 125VAC

Features

- Part of the radiant[®] collection of wiring devices, wall plates and home systems.
- Conducts an automatic test every three seconds, ensuring it's always ready to protect. If the device fails the test, the indicator light flashes to signal that the GFCI should be replaced. It also has our proven SafeLock Protection feature: if critical components are damaged and protection is lost, power to the receptacle is disconnected.
- Thinner than competitors' GFCI Receptacles: leaves more room for wires in the box.
- Auto-Ground clip assures a positive ground to metal box.
- Feed-thru wiring configuration allows GFCI to protect downstream receptacles.
- Prevents line-load reversal miswire: no power to the face or downstream receptacles if wired incorrectly.
- Exceeds UL943 voltage surge requirements.
- FSUL Listed (Federal Specification WC596).
- Trip indicator light (red LED).
- Ground screw has a back wire clamp for easy installation.
- Side or internal screw-pressure-plate back wire with #10 – #14 AWG solid or stranded copper wire.
- Two back wire holes per terminal.
- 10kA short circuit rating.
- Class A rated GFCI.
- Supplied with matching TP26 nylon wall plate.
- Tri-drive screws.
- GFCIs with Auto-Ground assure a positive ground to metal box.
- WR models listed to the Weather-Resistant supplement of UL498, meet demanding UL requirements.

Specifications

- Supply Voltage: 125VAC, 60 Hz
- Supply Voltage Range: 102-132 VAC
- Trio Threshold: 5± 1mA
- Trip Time: 0.025 sec., nominal per UL Standard
- 20 Amp feed-thru capacity

CATALOG NUMBER	RATING		COLOR	NEMA CONFIG. NO.	3rd PARTY COMPLIANCE		
	A.	VAC			UL943 C22.2 No. 144	UL498 C22.2 No. 42	FSUL WC596
NAFTA-COMPLIANT RADIANT[®] SPEC GRADE TAMPER-RESISTANT 15 AMP DUPLEX GFCI							
1597TRNAI	15	125	Ivory	5-15R	•	•	•
1597TRNAW	15	125	White	5-15R	•	•	•
1597TRNAGRY	15	125	Gray	5-15R	•	•	•
1597TRNALA	15	125	Light Almond	5-15R	•	•	•
NAFTA-COMPLIANT RADIANT[®] SPEC GRADE TAMPER-RESISTANT 20 AMP DUPLEX GFCI							
2097TRNAI	20	125	Ivory	5-20R	•	•	•
2097TRNAW	20	125	White	5-20R	•	•	•
2097TRNAGRY	20	125	Gray	5-20R	•	•	•
2097TRNALA	20	125	Light Almond	5-20R	•	•	•
NAFTA-COMPLIANT RADIANT[®] SPEC GRADE 20 AMP DUPLEX GFCI							
2097NAI	20	125	Ivory	5-20R	•	•	•
2097NAW	20	125	White	5-20R	•	•	•
2097NA	20	125	Brown	5-20R	•	•	•
2097NAGRY	20	125	Gray	5-20R	•	•	•
2097NALA	20	125	Light Almond	5-20R	•	•	•
2097NABL	20	125	Blue	5-20R	•	•	•
NAFTA-COMPLIANT RADIANT[®] SPEC GRADE TAMPER-RESISTANT / WEATHER-RESISTANT 15 AMP DUPLEX GFCI							
1597TRWRNAI	15	125	Ivory	5-15R	•	•	•
1597TRWRNAW	15	125	White	5-15R	•	•	•
1597TRWRNA	15	125	Brown	5-15R	•	•	•
1597TRWRNALA	15	125	Light Almond	5-15R	•	•	•
NAFTA-COMPLIANT RADIANT[®] SPEC GRADE TAMPER-RESISTANT / WEATHER-RESISTANT 20 AMP DUPLEX GFCI							
2097TRWRNAI	20	125	Ivory	5-20R	•	•	•
2097TRWRNAW	20	125	White	5-20R	•	•	•
2097TRWRNAGRY	20	125	Gray	5-20R	•	•	•
2097TRWRNALA	20	125	Light Almond	5-20R	•	•	•

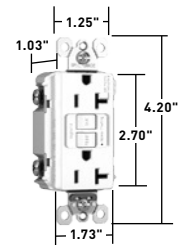

2097TRNAW

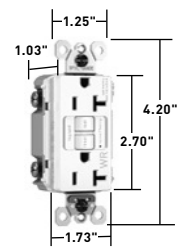

2097TRWRNAW

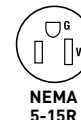

NAFTA-Compliant GFCI Receptacles are ideal for use on projects subject to the provisions of the Buy American Act.

All devices listed on this page conform to NEMA WD-1 and WD-6.

GFCIs

NAFTA-Compliant Hospital Grade Self-Test GFCI Receptacles with SafeLock® Protection

2 Pole, 3 Wire Grounding 15 & 20A, 125VAC

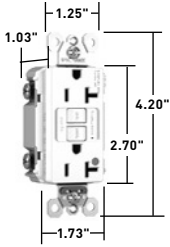

2097HGTRNAW

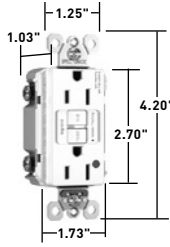

1597HGTRNAW

CATALOG NUMBER	RATING		COLOR	NEMA CONFIG. NO.	3rd PARTY COMPLIANCE		
	A.	VAC			UL943 C22.2 No. 144	UL498 C22.2 No. 42	FSUL WC596
NAFTA-COMPLIANT HOSPITAL GRADE TAMPER-RESISTANT 20 AMP DUPLEX GFCI							
2097HGTRNAI	20	125	Ivory	5-20R	•	•	•
2097HGTRNAW	20	125	White	5-20R	•	•	•
2097HGTRNARED	20	125	Red	5-20R	•	•	•
2097HGTRNALA	20	125	Light Almond	5-20R	•	•	•
NAFTA-COMPLIANT HOSPITAL GRADE 20 AMP DUPLEX GFCI							
2097HGNAI	20	125	Ivory	5-20R	•	•	•
2097HGNAW	20	125	White	5-20R	•	•	•
2097HGNAGRY	20	125	Gray	5-20R	•	•	•
2097HGNARED	20	125	Red	5-20R	•	•	•
2097HGNALA	20	125	Light Almond	5-20R	•	•	•

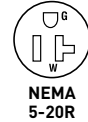
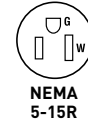

NAFTA-Compliant GFCI Receptacles are ideal for use on projects subject to the provisions of the Buy American Act.

GFCIs

NAFTA-Compliant PlugTail® Self-Test GFCI Receptacles with SafeLock® Protection 2 Pole, 3 Wire Grounding 15 & 20A, 125VAC

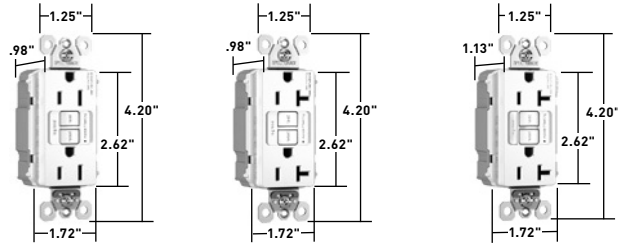

PT1597NAW

PT2097NAW

PT2097NTLTRNAW

Features

- Faster, more reliable installation.
- No exposed terminals create a finger safe application before, during, and after installation.
- Built-in connector features large brass terminal blades to ensure consistent, reliable electrical connections to PlugTail Connector.
- GFCI works with the existing 3-wire PlugTail Connectors creating a non-feed-thru application for facility owners. At rough-in just install the same right angle connector for GFCI and receptacle openings.
- Conducts an automatic test every three seconds, ensuring it's always ready to protect. If the device fails the test, the indicator light flashes to signal that the GFCI should be replaced. It also has our proven SafeLock Protection feature: if critical components are damaged and protection is lost, power to the receptacle is disconnected.
- Thinner than competitors' GFCI Receptacles: leaves more room for wires in the box.
- Auto-Ground clip assures a positive ground to metal box.
- FSUL Listed (Federal Specification WC596).
- Exceeds UL943 voltage surge requirements.
- Trip indicator light (red LED).
- Mounting screws are shipped captive in the device and wall plate for easier installation.
- High-impact-resistant thermoplastic construction.
- Zinc-plated steel mounting strap.
- Button colors match the device face.
- Dual-direction test and reset buttons.
- Class A rated GFCI.
- Supplied with matching TP26 nylon wall plate.
- Tri-drive screws.
- 10kA short circuit rating.

Specifications

- Supply Voltage: 125VAC, 60 Hz
- Supply Voltage Range: 102-132 VAC
- Trio Threshold: 5± 1mA
- Trip Time: 0.025 sec., nominal per UL Standard

CATALOG NUMBER	RATING		COLOR	NEMA CONFIG. NO.	3rd PARTY COMPLIANCE		
	A.	VAC			UL943 C22.2 No. 144	UL498 C22.2 No. 42	FSUL WC596
NAFTA-COMPLIANT SPEC GRADE 15 AMP DUPLEX GFCI							
PT1597NAW	15	125	White	5-15R	•	•	•
PT1597NAGRY	15	125	Gray	5-15R	•	•	•
PT1597NALA	15	125	Light Almond	5-15R	•	•	•
NAFTA-COMPLIANT SPEC GRADE 20 AMP DUPLEX GFCI							
PT2097NAW	20	125	White	5-20R	•	•	•
PT2097NABK	20	125	Black	5-20R	•	•	•
PT2097NALA	20	125	Light Almond	5-20R	•	•	•
NAFTA-COMPLIANT SPEC GRADE TAMPER-RESISTANT 20 AMP DUPLEX GFCI							
PT2097TRNAI	20	125	Ivory	5-20R	•	•	•
PT2097TRNAW	20	125	White	5-20R	•	•	•
PT2097TRNALA	20	125	Light Almond	5-20R	•	•	•
NAFTA-COMPLIANT SPEC GRADE TAMPER-RESISTANT 15 AMP COMBINATION NIGHT LIGHT/GFCI							
PT1597NTLTRNAW	15	125	White	5-15R	•	•	•
NAFTA-COMPLIANT SPEC GRADE TAMPER-RESISTANT 20 AMP COMBINATION NIGHT LIGHT/GFCI							
PT2097NTLTRNAI	20	125	Ivory	5-20R	•	•	•
PT2097NTLTRNAW	20	125	White	5-20R	•	•	•



NAFTA-Compliant GFCI Receptacles are ideal for use on projects subject to the provisions of the Buy American Act. For PlugTail Connector catalog numbers, see Page C-13 or C-14.

All devices listed on this page conform to NEMA WD-1 and WD-6.

GFCIs

NAFTA-Compliant PlugTail® Hospital Grade Self-Test GFCI Receptacles with SafeLock® Protection 2 Pole, 3 Wire Grounding 15 & 20A, 125VAC

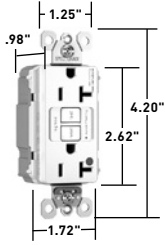

PT2097HGNAW

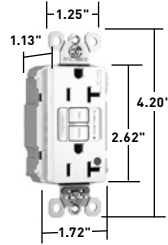

PT2097HGNTLTRW

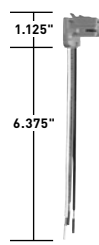

PTR6STR

Features

- Faster, more reliable installation.
- No exposed terminals create a finger safe application before, during, and after installation.
- Built-in connector features large brass terminal blades to ensure consistent, reliable electrical connections to PlugTail Connector.
- GFCI works with the existing 3-wire PlugTail Connectors creating a non-feed-thru application for facility owners. At rough-in just install the same right angle connector for GFCI and receptacle openings.
- Conducts an automatic test every three seconds, ensuring it's always ready to protect. If the device fails the test, the indicator light flashes to signal that the GFCI should be replaced. It also has our proven SafeLock Protection feature: if critical components are damaged and protection is lost, power to the receptacle is disconnected.
- Thinner than competitors' GFCI Receptacles: leaves more room for wires in the box.
- Auto-Ground clip assures a positive ground to metal box.
- FSUL Listed (Federal Specification WC596).
- Exceeds UL943 voltage surge requirements.
- Trip indicator light (red LED).
- Mounting screws are shipped captive in the device and wall plate for easier installation.
- High-impact-resistant thermoplastic construction.
- Zinc-plated steel mounting strap.
- Button colors match the device face.
- Dual-direction test and reset buttons.
- Class A rated GFCI.
- Supplied with matching TP26 nylon wall plate.
- Tri-drive screws.
- 10kA short circuit rating.

Specifications

- Supply Voltage: 125VAC, 60 Hz
- Supply Voltage Range: 102-132 VAC
- Trio Threshold: 5± 1mA
- Trip Time: 0.025 sec., nominal per UL Standard

CATALOG NUMBER	RATING		LIGHT OUTPUT IN 1' FCD*	COLOR	NEMA CONFIG. NO.	3rd PARTY COMPLIANCE		
	A.	VAC				UL943 C22.2 No. 144	UL498 C22.2 No. 42	FSUL WC596
NAFTA-COMPLIANT HOSPITAL GRADE 20 AMP DUPLEX GFCI								
PT2097HGNAI	20	125	0.180	Ivory	5-20R	•	•	•
PT2097HGNAW	20	125	0.180	White	5-20R	•	•	•
PT2097HGNAGRY	20	125	0.180	Gray	5-20R	•	•	•
PT2097HGNARED	20	125	0.180	Red	5-20R	•	•	•
NAFTA-COMPLIANT HOSPITAL GRADE TAMPER-RESISTANT 20 AMP DUPLEX GFCI								
PT2097HGTRNAI	20	125	0.180	Ivory	5-20R	•	•	•
PT2097HGTRNAW	20	125	0.180	White	5-20R	•	•	•
PT2097HGTRNAGRY	20	125	0.180	Gray	5-20R	•	•	•
NAFTA-COMPLIANT HOSPITAL GRADE TAMPER-RESISTANT 20 AMP COMBINATION NIGHT LIGHT/GFCI								
PT2097HGNTLTRNAI	20	125	0.180	Ivory	5-20R	•	•	•

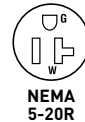
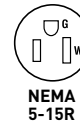

CATALOG NUMBER	WIRE TYPE	WIRE LENGTH
PLUGTAIL CONNECTORS - RIGHT ANGLE		
PTRA6STR	Stranded	6"
PTRA6SOL	Solid	6"

All PlugTail Connectors are available in any wire length up to 25 inches, consult factory to order.

NAFTA-Compliant GFCI Receptacles are ideal for use on projects subject to the provisions of the Buy American Act.

For additional PlugTail Connectors, see Page B-4.

All devices listed on this page conform to NEMA WD-1 and WD-6.

GFCIs

the radiant[®]
collection

Extension Rings & radiant[®] RoHS-Compliant Spec Grade Tamper-Resistant Duplex GFCI Receptacles with SafeLock[®] Protection 2 Pole, 3 Wire Grounding 15 & 20A, 125VAC

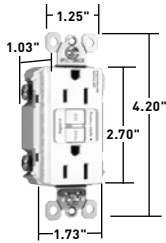

1597TRRW

The radiant[®] collection is a step up from the standard with simple, classic options in wiring devices, home automation controls, and screwless wall plates that complement today's homes and hospitality settings.

CATALOG NUMBER	RATING		COLOR	NEMA CONFIG. NO.	3rd PARTY COMPLIANCE		
	A.	VAC			UL943 C22.2 No. 144	UL498 C22.2 No. 42	FSUL WC596
ROHS-COMPLIANT RADIANT[®] SPEC GRADE TAMPER-RESISTANT 15 AND 20 AMP DUPLEX GFCI							
1597TRRI	15	125	Ivory	5-15R	•	•	•
1597TRRW	15	125	White	5-15R	•	•	•
1597TRRLA	15	125	Light Almond	5-15R	•	•	•
2097TRRI	20	125	Ivory	5-20R	•	•	•

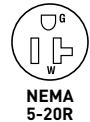
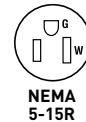

CATALOG NUMBER	COLOR
GFCI EXTENSION RINGS	
1594TPAI	7.0 cu. in. Extension Ring, Ivory
1594TPAW	7.0 cu. in. Extension Ring, White
1594TPA	7.0 cu. in. Extension Ring, Brown
1594TPALA	7.0 cu. in. Extension Ring, Light Almond



1594TPAW
EXTENSION RING

RoHS-Compliant GFCI Receptacles meet the requirements of Restriction of Hazardous Substances directives and regulations.

All devices listed on this page conform to NEMA WD-1 and WD-6.

GFCIs

Portables



Applications

All Pass & Seymour Portable GFCIs meet OSHA and NEC requirements to provide ground fault protection for personnel utilizing temporary power during construction, remodeling, maintenance, repair and demolition. Can be used with power tools, high-pressure power washers, wet vacuums, and grounds keeping equipment. Also used on spas, hot tubs, vending machines, and portable signs to provide ground fault protection.

Open Neutral Protection

All Pass & Seymour Portable GFCIs have an open neutral relay that automatically cuts off power to the line (hot) conductor of the device in the event that the neutral wire preceding the GFCI becomes severed. For example, if your portable GFCI were plugged into an extension cord that was supplying the power and the neutral conductor on that extension cord was accidentally cut (as can happen on a job site), the open neutral relay would shut off power to the hot conductor. This provides an additional level of safety from possible ground faults.

Features and Specifications

- Durable polycarbonate case withstands hard use.
- Indicator light is on when power is available.
- Open neutral protection.
- Supply Voltage: 125VAC, 60 Hz
- Supply Voltage: 120-132VAC
- Operating Temperature: -35°C (-30°F) to +66°C (150°F)
- Trip Time: .025 sec., nominal per UL Standard
- Trip Threshold: 5±1mA
- Cord Grip Range: .30"-.46"
- RoHS-Compliant.

CATALOG NUMBER	RESET	COLOR	RATING		NEMA CONFIG. NO.	GFCI	RIGHT ANGLE PLUG	3rd PARTY COMPLIANCE		
			A.	V.				UL943	UL498	C22.2 No. 144
RIGHT ANGLE PLUG - PORTABLE GFCI										
1594CMM	Manual	Yellow	15	125	5-15P		User attachable	•	•	•
1594CMA	Automatic	Black	15	125	5-15P		User attachable	•	•	•



1594CMM

RoHS-Compliant Portable GFCIs meet the requirements of Restriction of Hazardous Substances directives and regulations.

Manual Reset GFCI

Requires the GFCI to be manually set for use by pressing the reset button upon plug in and after loss of primary power (power failure or unplugging the device). Must be manually reset after a ground fault condition. Ideal for applications where operator injury might occur if equipment were to restart after a power failure. Typical equipment includes power drills, saws, lathes, and grinders.

Automatic Reset GFCI

Automatically energizes or sets the GFCI for use upon plug in and after the loss of primary power (power failure or unplugging the device). After a ground fault condition, must be reset by pushing the reset button. This feature eliminates the need for unit to be reset each time it is plugged in or powered up. Ideal for equipment intended for continuous use where a temporary power failure is likely and undesirable. Examples are pumps, pressure washers, portable signs, or lighting and engine heaters.

GFCIs

Portables



Features and Specifications

- Durable polycarbonate case withstands hard use.
- Indicator light is on when power is available.
- Open neutral protection.
- Optional Turnlok® plugs and connectors prevent accidental disconnection.
- Optional tri-cord connector handles up to three loads.
- Supply Voltage: 125VAC, 60 Hz
- Supply Voltage: 120-132VAC
- Operating Temperature: -35°C (-30°F) to +66°C (150°F)
- Trip Time: .025 sec., nominal per UL Standard
- Trip Threshold: 5±1mA
- RoHS-Compliant.

CATALOG NUMBER	DESCRIPTION	RESET	COLOR	RATING		NEMA CONFIG NO.	PLUG	CONN.	3rd PARTY COMPLIANCE	
				A.	V.				UL943 C22.2 No. 144	UL498 C22.2 No. 42
15 AMP IN-LINE – PORTABLE GFCI										
1594PC6M	6' cord, straight blade	Manual	Yellow	15	125	5-15P/R			•	•
1594PC2M	2' cord, straight blade	Manual	Yellow	15	125	5-15P/R			•	•
1594PC2A	2' cord, straight blade	Auto.	Black	15	125	5-15P/R			•	•
1594TC2M	2' cord with tri-cord connector	Manual	Yellow	15	125	5-15P/R			•	•
1594TC2A	2' cord with tri-cord connector	Auto.	Black	15	125	5-15P/R			•	•
1594TL2M	2' cord, Turnlok®	Manual	Yellow	15	125	L5-15P/R				
1594TL2A	2' cord, Turnlok®	Auto.	Black	15A	125	L5-15P/R				
20 AMP IN-LINE PORTABLE GFCI										
2094PC2A	2' cord, straight blade	Auto.	Black	20	125	5-20P/R			•	•
2094PC2M	2' cord, straight blade	Manual	Yellow	20	125	5-20P/R			•	•
2094TL2A	2' cord, Turnlok®	Auto.	Black	20	125	L5-20P/R			•	•
2094TL2M	2' cord, Turnlok®	Manual	Yellow	20	125	L5-20P/R			•	•

CATALOG NUMBER	DESCRIPTION	RESET	COLOR	RATING		NEMA CONFIG. NO.	RIGHT ANGLE PLUG	3rd PARTY COMPLIANCE		
				A.	V.			UL943 C22.2 No. 144	UL498 C22.2 No. 42	
RIGHT ANGLE PLUG – PORTABLE GFCI										
1594CS1M	1' cord with connector	Manual	Yellow	15	125	5-15P/R			•	•
1594CS1A	1' cord with connector	Automatic	Black	15	125	5-15P/R			•	•

RoHS-Compliant Portable GFCIs meet the requirements of Restriction of Hazardous Substances directives and regulations.

All devices listed on this page conform to NEMA WD-1 and WD-6.

GFCIs

Portables



PL204L

Features and Specifications

- Handles up to four loads.
- Open neutral protection.
- High-impact-resistant thermoplastic housing.
- Optional Turnlok® plugs and connectors prevent accidental disconnection.
- Supply Voltage: 125VAC, 60 Hz
- Supply Voltage: 120-132VAC
- Trip Threshold: 5±1mA
- Trip Time: .025 sec., nominal per UL Standard
- Case Material: Yellow Thermoplastic

CATALOG NUMBER	DESCRIPTION	RATING		NEMA CONFIG. NO.	PLUG	RECEPTACLE	3rd PARTY COMPLIANCE		
		A.	V.				UL943	UL498	
AUTO RESET BOXES – PORTABLE GFCI									
PS154S	Four 15A, 125V straight blade outlets. Cord has 15A, 125V plug	15	125	5-15P 5-15R					• •
PS204S	Four 20A, 125V straight blade outlets. Cord has 20A, 125V plug	20	125	5-20P 5-20R					• •
PL204L	Two 20A, 125V straight blade outlets and one 20A 125V locking outlet has 20A, 125V locking plug	20	125	L5-20P L5-20R 5-20R					• •

AFCIs



Pass & Seymour Outlet Branch Circuit Arc-Fault Circuit Interrupter (AFCI) Receptacles and Dual-Function AFCI/GFCI Receptacles are the latest innovations in electrical safety technology, and a Code-approved, cost-effective alternative to AFCI and Dual-Function AFCI/GFCI breakers.

Designed to protect against electrical fires caused by arc faults and injury due to electrical shock, these devices are compliant with NEC® requirements for new construction, circuit modifications/extensions and replacement receptacles.

And like GFCI receptacles, AFCI and Dual-Function AFCI/GFCI receptacles are installed in the living space so homeowners can see the indicator light and perform TEST and RESET locally.

Featured Products



RADIANT® TAMPER-RESISTANT DUAL FUNCTION AFCI/GFCI RECEPTACLES D-3

radiant® Tamper-Resistant AFCI Receptacles	D-2
radiant® Tamper-Resistant Dual Function AFCI/GFCI Receptacles	D-3

AFCIs

radiant® Tamper-Resistant AFCI Receptacles

2 Pole, 3 Wire Grounding 15 & 20A, 125VAC

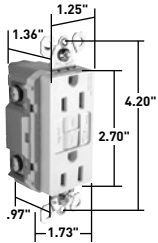

AF152TRW

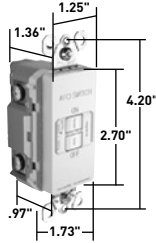

AF202DFLA

The radiant® collection is a step up from the standard with simple, classic options in wiring devices, home automation controls, and screwless wall plates that complement today's homes and hospitality settings.

Features

- Part of the radiant® collection of wiring devices, wall plates and home systems.
- Protects against electrical fires by detecting arc faults and deenergizing the circuit.
- Compliant with NEC® AFCI requirements
- Patented SafeLock® Protection – if critical components are damaged and protection is lost, power to the receptacle is disconnected.
- FSUL listed (Federal Specification WC596).
- Readily accessible – TEST and RESET buttons located on face of device at point of use. Easier to troubleshoot for homeowner, means less callbacks for contractor.
- Easier installation than breakers. Fits any wall box: no need to match the brand of the breaker box.
- Can be installed on a circuit with shared neutrals on the line side.
- Trip indicator light. Red when device is tripped.
- Feed-through protection.
- Two back wire holes per termination add wiring flexibility, eliminate pigtail and save box space.
- High impact-resistant, thermoplastic construction for superior strength and durability.
- Ground terminal back wire for fast installation.
- Tamper-Resistant – automatic shutter system prevents young children from inserting common household objects. Black shutters essentially disappear into the background for an invisible effect preferred by end users.
- Auto-ground clip assures a positive ground to a metal box.
- Dead Front is rated as 1 1/2 HP motor control switch.

CATALOG NUMBER	RATING		COLOR	NEMA CONFIG. NO.	3rd PARTY COMPLIANCE			
	A.	V.			UL1699A	cULus UL498	FSUL WC596	CSA C22.2 No. 42
RADIANT® TAMPER-RESISTANT OUTLET BRANCH CIRCUIT AFCI RECEPTACLE								
AF152TRW	15A	125V	White	5-15R	•	•	•	•
AF152TRI	15A	125V	Ivory	5-15R	•	•	•	•
AF152TR	15A	125V	Brown	5-15R	•	•	•	•
AF152TRBK	15A	125V	Black	5-15R	•	•	•	•
AF152TRLA	15A	125V	Light Almond	5-15R	•	•	•	•
AF152TRGRY	15A	125V	Gray	5-15R	•	•	•	•
RADIANT® TAMPER-RESISTANT OUTLET BRANCH CIRCUIT AFCI RECEPTACLE								
AF202TRW	20A	125V	White	5-20R	•	•	•	•
AF202TRI	20A	125V	Ivory	5-20R	•	•	•	•
AF202TR	20A	125V	Brown	5-20R	•	•	•	•
AF202TRBK	20A	125V	Black	5-20R	•	•	•	•
AF202TRLA	20A	125V	Light Almond	5-20R	•	•	•	•
AF202TRGRY	20A	125V	Gray	5-20R	•	•	•	•
RADIANT® DEAD FRONT OUTLET BRANCH CIRCUIT AFCI								
AF202DFW	20A	125V	White	—	•	•	•	•
AF202DFI	20A	125V	Ivory	—	•	•	•	•
AF202DFLA	20A	125V	Light Almond	—	•	•	•	•

2 Pole, 3 Wire

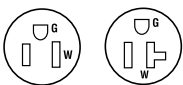

NEMA 5-15R

NEMA 5-20R

AFCIs

the radiant[®]
collection

radiant[®] Tamper-Resistant Dual Function AFCI/GFCI Receptacles

2 Pole, 3 Wire Grounding 15 & 20A, 125VAC

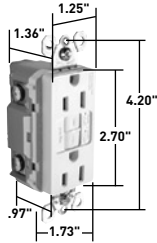

AFGF152TRW

The radiant[®] collection is a step up from the standard with simple, classic options in wiring devices, home automation controls, and screwless wall plates that complement today's homes and hospitality settings.

Features

- Part of the radiant[®] collection of wiring devices, wall plates and home systems.
- Protects against electrical fires caused by arc faults and injury due to electrical shock.
- Compliant with NEC[®] AFCI and GFCI requirements.
- Self-Test GFCI – conducts an automatic test every three seconds, ensuring it's always ready to protect. If the device fails the test, the indicator light flashes to signal that the GFCI should be replaced.
- Patented SafeLock[®] Protection – if critical components are damaged and protection is lost, power to the receptacle is disconnected.
- FSUL listed (Federal Specification WC596).
- Readily accessible – TEST and RESET buttons located on face of device at point of use. Easier to troubleshoot for homeowner, means less callbacks for contractor.
- Easier installation than breakers. Fits any wall box: no need to match the brand of the breaker box.
- Can be installed on a circuit with shared neutrals on the line side.
- Two indicator lights, one for GFCI and one for AFCI. Easy to distinguish between trip caused by arc fault and trip caused by ground fault. GFCI indicator light flashes if device fails the GFCI self-test, signaling that device should be replaced.
- Feed-through protection.
- Two back wire holes per termination add wiring flexibility, eliminate pigtail and save box space.
- High impact-resistant, thermoplastic construction for superior strength and durability.
- Ground terminal back wire for fast installation.
- Tamper-Resistant – automatic shutter system prevents young children from inserting common household objects. Black shutters essentially disappear into the background for an invisible effect preferred by end users.
- Auto-ground clip assures a positive ground to a metal box.
- Dead Front is rated as 1 1/2 HP motor control switch.

CATALOG NUMBER	RATING		COLOR	NEMA CONFIG. NO.	3rd PARTY COMPLIANCE				
	A.	V.			UL1699A	UL943	UL498	FSUL WC596	CSA C22.2 No. 42
RADIANT[®] TAMPER-RESISTANT DUAL FUNCTION AFCI/GFCI RECEPTACLE									
AFGF152TRW	15A	125V	White	5-15R	•	•	•	•	•
AFGF152TRI	15A	125V	Ivory	5-15R	•	•	•	•	•
AFGF152TR	15A	125V	Brown	5-15R	•	•	•	•	•
AFGF152TRBK	15A	125V	Black	5-15R	•	•	•	•	•
AFGF152TRLA	15A	125V	Light Almond	5-15R	•	•	•	•	•
AFGF152TRGRY	15A	125V	Gray	5-15R	•	•	•	•	•
RADIANT[®] DEAD FRONT OUTLET BRANCH CIRCUIT AFCI/GFCI RECEPTACLE									
AFGF202TRW	20A	125V	White	5-20R	•	•	•	•	•
AFGF202TRI	20A	125V	Ivory	5-20R	•	•	•	•	•
AFGF202TR	20A	125V	Brown	5-20R	•	•	•	•	•
AFGF202TRBK	20A	125V	Black	5-20R	•	•	•	•	•
AFGF202TRLA	20A	125V	Light Almond	5-20R	•	•	•	•	•
AFGF202TRGRY	20A	125V	Gray	5-20R	•	•	•	•	•
RADIANT[®] DEAD FRONT OUTLET BRANCH CIRCUIT AFCI/GFCI RECEPTACLE									
AFGF202DFW	20A	125V	White	5-20R	•	•	•	•	•
AFGF202DFI	20A	125V	Ivory	5-20R	•	•	•	•	•
AFGF202DFLA	20A	125V	Light Almond	5-20R	•	•	•	•	•

2 Pole, 3 Wire

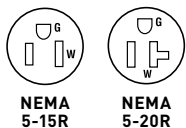

All devices listed on this page conform to NEMA WD-1 and WD-6.

HOSPITAL GRADE DEVICES



Featured Products



PLUGTAIL® EXTRA HEAVY-DUTY RECEPTACLES E-3



USB CHARGERS WITH TAMPER-RESISTANT RECEPTACLES E-21

Receptacle Test Requirements	E-2	Heavy-Duty Decorator Receptacles	E-19
PlugTail® Extra Heavy-Duty & Tamper-Resistant Receptacles	E-3	USB Chargers with Tamper-Resistant Receptacles	E-21
PlugTail® Extra Heavy-Duty Power Indicating Tamper-Resistant Receptacles	E-5	GFCI Receptacles	E-22
PlugTail® Extra Heavy-Duty Illuminated Receptacles	E-6	Isolated Ground & Audible Alarm Tamper-Resistant GFCI Receptacles	E-23
Extra Heavy-Duty Receptacles	E-7	Decorator Combination Tamper-Resistant Night Light/GFCI Receptacles	E-24
Extra Heavy-Duty MRI Receptacles	E-8	PlugTail® GFCI Receptacles	E-25
Heavy-Duty Receptacles	E-9	PlugTail® Tamper-Resistant Night Light/GFCI Receptacles	E-27
PlugTail® Specification Grade Receptacles	E-11	NAFTA-Compliant GFCI Receptacles	E-28
Single Receptacles	E-13	NAFTA-Compliant PlugTail® GFCI Receptacles	E-29
Tamper-Resistant Receptacles	E-14	Surge Protective Receptacles	E-30
Hospital Grade Tamper-Resistant Power Indicating Receptacles	E-15	PlugTail® Surge Protective Receptacles	E-31
Isolated Ground Receptacles	E-16	Tamper-Resistant Surge Protective Receptacles	E-32
Tamper-Resistant Isolated Ground Receptacles	E-17	Straight Blade Plugs & Connectors	E-33
PlugTail® Decorator Receptacles	E-18	Quad Receptacles	E-34

HOSPITAL GRADE DEVICES

Receptacle Test Requirements

All straight blade receptacles must pass a sequence of tests established in UL498. To earn the "Hospital Grade" rating a device must pass an additional series of abuse and performance tests.

Abrupt Plug Removal Test

After ten conditioning insertion and withdrawal cycles of an attachment plug of matching configuration and ground pin, each outlet is to hold without any displacement a fully inserted test pin for at least one minute from a face down horizontal position. Then each receptacle is mounted to represent a typical installation and go through a series of abrupt removal tests – the full insertion of a test plug that is removed by dropping an attached 10-pound weight two feet, thus exerting excessive force on the receptacle face and contacts. Each outlet must go through eight cycles of this test, two in the initial position, then rotated 180 degrees for the next four cycles, then back to the original position for the final two cycles. Duplex receptacles are tested by having one outlet with the ground pin in the 12 o'clock and 6 o'clock positions, the other in the 3 o'clock and 9 o'clock positions. After testing, each outlet, while in the face down horizontal position must hold without displacement a .184" diameter 4-ounce ground pin for one minute. The outlet must have no breakage that would interfere with its function and integrity.

Ground Contact Overstress Test

The receptacle ground contact is conditioned with twenty cycles of full insertion and withdrawal of a .204" oversized test pin. Then, with the receptacle in a horizontal face down position, the same contact must retain a .184" diameter 4-ounce test pin for at least one minute without any displacement.

Impact Test

Receptacles mounted in a cast metal box are placed on a steel plate facing upward. A 5-pound weight is dropped from 18" above the device impacting at the center of the outlet. The device must withstand the impact without having any breakage that hinders its function.

Assembly Security Test

A device, supported at its mounting screws, must withstand 100 pounds through the slots in the receptacle face without cracking the device back body or deforming the yoke.

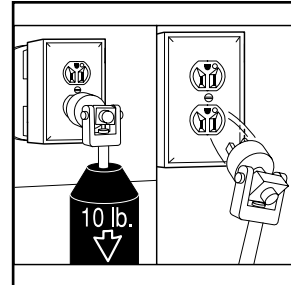

Abrupt Plug Removal Test

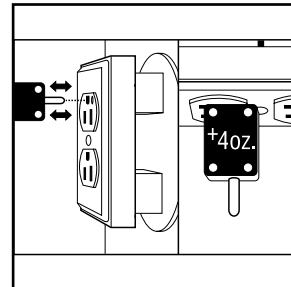

Ground Contact Overstress Test

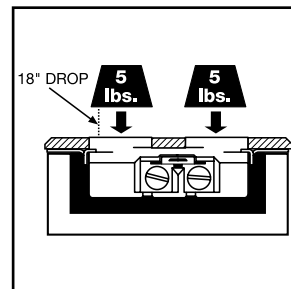

Impact Test

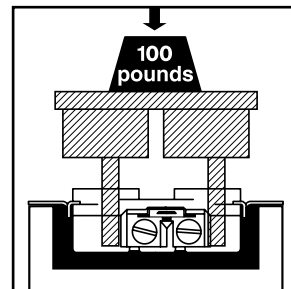

Assembly Security Test

HOSPITAL GRADE DEVICES



PT8300W PlugTail® Extra Heavy-Duty Duplex Receptacle

- A. Strap tabs wrap around and lock down on face** to prevent strap from separating from face and back body.
 - B. Auto-ground clip** assures positive ground.
 - C. Exclusive patented feature, circuit label on face** allows permanent circuit identification.
 - D. No exposed terminals** create a finger safe application before, during, and after installation.
 - E. .036 inch thick, brass, triple-wipe power contacts** for lasting retention.
 - F. Built-in connector** features large brass terminal blades to ensure consistent, reliable electrical connections.
 - G. Large brass contacts** snugly terminate on device blade terminals. Audible snapping latch assures connection, allows release.
 - H. Ultrasonically welded polycarbonate connector housing** secures terminations and conductors in a UL Listed, finger safe housing.
 - I. Pre-stripped connector leads** fasten to conductors, easier than standard pigtailed.
- Two drive screws anchor strap** to back body and face.

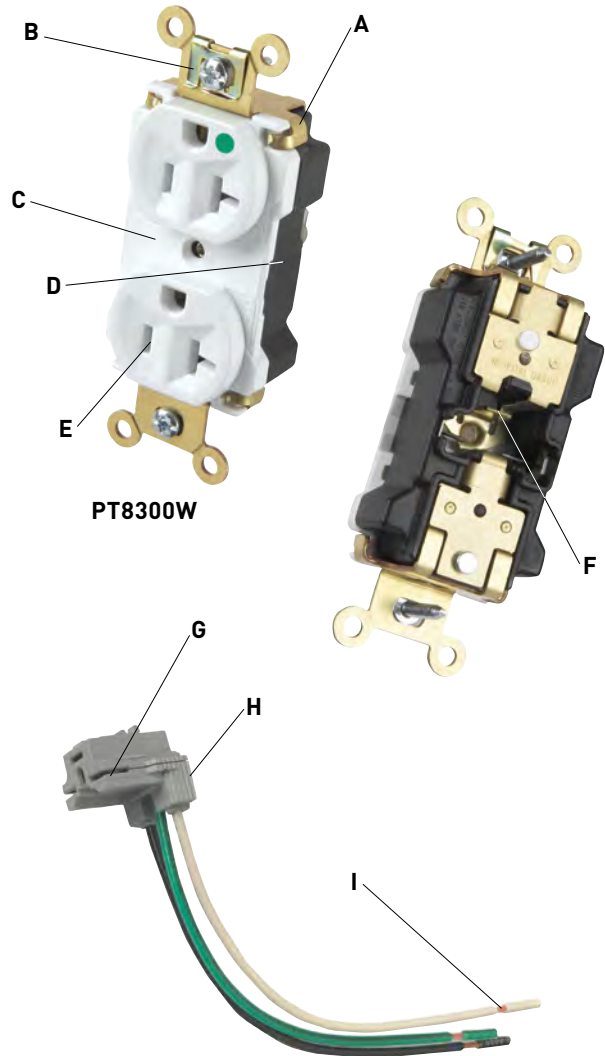

All of our Hospital Grade devices are designed for optimum durability, performance, and reliability — to help make today's facility maintenance operations more productive and consistent.



PTR650L PTR650LBP PTR650LGB

CATALOG NUMBER	WIRE TYPE	CONNECTOR HEAD	WIRE LENGTH
PLUGTAIL CONNECTORS – RIGHT ANGLE			
PTR650L	Solid		6"
PTR650LBP	Stranded		6"
PTR650LGB	Solid		25"
PTR650LGBP	Stranded		25"
NAFTA-COMPLIANT PLUGTAIL CONNECTORS – RIGHT ANGLE			
PTR650LNA	Solid		6"
PTR650LNB	Stranded	Blue	6"
PTR650LNC	Stranded	Orange	6"
PTR650LND	Stranded	Red	6"

CATALOG NUMBER	WIRE TYPE	WIRE LENGTH
PLUGTAIL CONNECTORS – RIGHT ANGLE WITH WAGO CONNECTORS		
PTR650LBP	Solid	6"
PTR650LBP	Stranded	6"
PLUGTAIL CONNECTORS – RIGHT ANGLE WITH GROUND SCREW		
PTR650LG	Solid	6"
PTR650LGB	Stranded	6"

HOSPITAL GRADE DEVICES

PlugTail® Extra Heavy-Duty Receptacles & Tamper-Resistant Receptacles 15 & 20A, 125V

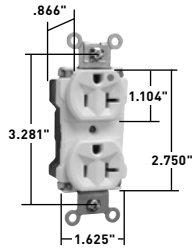

PT8300W

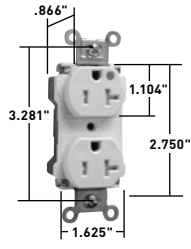

PTTR63HW



Features

- Patented feature, circuit label on face allows permanent circuit identification.
- .036 inch thick, brass, triple-wipe power contacts for lasting retention.
- Strap tabs wrap around and lock down on face to prevent strap from separating from face and back body.
- No exposed terminals create a finger safe application before, during and after installation.
- Built-in connector features large brass terminal blades to ensure consistent, reliable electrical connections.
- Crimped and welded contacts.
- Ultrasonically welded polycarbonate connector housing secures terminations and conductors in a UL Listed, finger safe housing.
- Large brass contacts snugly terminate on device blade terminals.
- Pre-stripped connector leads fasten to conductors, easier than standard pigtails.
- Auto-ground clip assures positive ground.
- Tamper-resistant version features dual mechanical shutter system to help prevent insertion of foreign objects.

CATALOG NUMBER	RATING		COLOR	NEMA CONFIG. NO.	3 rd PARTY COMPLIANCE	
	A.	V.			UL498	FSUL WC596
DUPLEX RECEPTACLES						
PT8200I	15	125	Ivory	5-15R	•	•
PT8200W	15	125	White	5-15R	•	•
PT8200GRY	15	125	Gray	5-15R	•	•
PT8200BK	15	125	Black	5-15R	•	•
PT8200RED	15	125	Red	5-15R	•	•
PT8200LA	15	125	Light Almond	5-15R	•	•
PT8200BL	15	125	Blue	5-15R	•	•
PT8300I	20	125	Ivory	5-20R	•	•
PT8300W	20	125	White	5-20R	•	•
PT8300	20	125	Brown	5-20R	•	•
PT8300GRY	20	125	Gray	5-20R	•	•
PT8300BK	20	125	Black	5-20R	•	•
PT8300RED	20	125	Red	5-20R	•	•
PT8300LA	20	125	Light Almond	5-20R	•	•
PT8300BL	20	125	Blue	5-20R	•	•
TAMPER-RESISTANT DUPLEX RECEPTACLES						
PTTR62HI	15	125	Ivory	5-15R	•	•
PTTR62HW	15	125	White	5-15R	•	•
PTTR62HBK	15	125	Black	5-15R	•	•
PTTR62HRED	15	125	Red	5-15R	•	•
PTTR63HI	20	125	Ivory	5-20R	•	•
PTTR63HW	20	125	White	5-20R	•	•
PTTR63H	20	125	Brown	5-20R	•	•
PTTR63HGRY	20	125	Gray	5-20R	•	•
PTTR63HBK	20	125	Black	5-20R	•	•
PTTR63HRED	20	125	Red	5-20R	•	•
PTTR63HLA	20	125	Light Almond	5-20R	•	•

2 Pole, 3 Wire

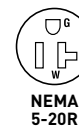
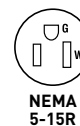

For PlugTail Connectors, see Page E-18.

For Bulk Packaging Solutions consult factory.

HOSPITAL GRADE DEVICES

PlugTail® Extra Heavy-Duty Power Indicating Tamper-Resistant Receptacles 15 & 20A, 125V

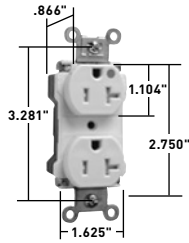

PTTR8300PIGRY

Features

- Exclusive, wrap-around green LEDs offer clear visual assurance of power indication at the receptacle.
- Patented feature, circuit label on face allows permanent circuit identification.
- .036 inch thick, brass, triple-wipe power contracts for lasting retention.
- Strap tabs wrap around and lock down on face to prevent strap from separating from face and back body.
- No exposed terminals create a finger safe application before, during and after installation.
- Built-in connector features large brass terminal blades to ensure consistent, reliable electrical connections.
- Crimped and welded contacts.
- Ultrasonically welded polycarbonate connector housing secures terminations and conductors in a UL Listed, finger safe housing.
- Large brass contacts snugly terminate on device blade terminals.
- Pre-stripped connector leads fasten to conductors, easier than standard pigtailed.
- Auto-ground clip assures positive ground.
- Tamper-resistant version features dual mechanical shutter system to help prevent insertion of foreign objects.

CATALOG NUMBER	RATING		COLOR	NEMA CONFIG. NO.	3rd PARTY COMPLIANCE		
	A.	V.			UL498	FSUL WC596	C22.2 No. 42
POWER-INDICATING TAMPER-RESISTANT DUPLEX RECEPTACLES							
PTTR8200PI	15A	125V	Brown	5-15R	•	•	•
PTTR8200PIW	15A	125V	White	5-15R	•	•	•
PTTR8200PILA	15A	125V	Light Almond	5-15R	•	•	•
PTTR8200PII	15A	125V	Ivory	5-15R	•	•	•
PTTR8200PIRED	15A	125V	Red	5-15R	•	•	•
PTTR8200PIRY	15A	125V	Gray	5-15R	•	•	•
PTTR8300PI	20A	125V	Brown	5-20R	•	•	•
PTTR8300PIW	20A	125V	White	5-20R	•	•	•
PTTR8300PILA	20A	125V	Light Almond	5-20R	•	•	•
PTTR8300PII	20A	125V	Ivory	5-20R	•	•	•
PTTR8300PIRED	20A	125V	Red	5-20R	•	•	•
PTTR8300PIGRY	20A	125V	Gray	5-20R	•	•	•

2 Pole, 3 Wire

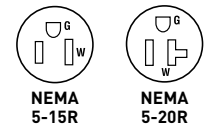

For PlugTail Connectors, see Page E-18.

HOSPITAL GRADE DEVICES

PlugTail® Extra Heavy-Duty Illuminated Receptacles 15 & 20A, 125V

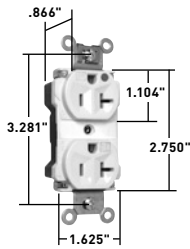

PT8300ILLA



PTTESTER



Features

- Molded-in "IL" markings on face of product.
- Illuminated face indicated power to receptacle and makes it easy to identify receptacle in dark applications.
- Patented feature, circuit label on face allows permanent circuit identification.
- .036 inch thick, brass, triple-wipe power contacts for lasting retention.
- Strap tabs wrap around and lock down on face to prevent strap from separating from face and back body.
- No exposed terminals create a finger safe application before, during, and after installation.
- Built-in connector features large brass terminal blades to ensure consistent, reliable electrical connections.
- Crimped and welded contacts.
- Ultrasonically welded polycarbonate connector housing secures terminations and conductors in a UL Listed, finger safe housing.
- Large brass contacts snugly terminate on device blade terminals.
- Pre-stripped connector leads fasten to conductors, easier than standard pigtails.
- Auto-ground clip assures positive ground.

CATALOG NUMBER	RATING		COLOR	NEMA CONFIG. NO.	3 rd PARTY COMPLIANCE	
	A.	V.			UL498	FSUL WC596
ILLUMINATED DUPLEX RECEPTACLES						
PT8200ILI	15	125	Ivory	5-15R	•	•
PT8200ILW	15	125	White	5-15R	•	•
PT8200ILGRY	15	125	Gray	5-15R	•	•
PT8200ILBK	15	125	Black	5-15R	•	•
PT8200ILRED	15	125	Red	5-15R	•	•
PT8200ILLA	15	125	Light Almond	5-15R	•	•
PT8300ILI	20	125	Ivory	5-20R	•	•
PT8300ILW	20	125	White	5-20R	•	•
PT8300IL	20	125	Brown	5-20R	•	•
PT8300ILGRY	20	125	Gray	5-20R	•	•
PT8300ILRED	20	125	Red	5-20R	•	•
PT8300ILLA	20	125	Light Almond	5-20R	•	•

For PlugTail Connectors, see Page E-18.

For Bulk Packaging Solutions consult factory.

Features

- Ensures proper connections and power presence at both rough-in and device-out stages during P&S PlugTail Device installation.
- Fast, easy identification of circuit connections.
- Easy-to-see indicator lights.
- Sturdy construction for long-term dependability.
- Helps prevent call backs.
- Ensures proper wiring.

CATALOG NUMBER	COLOR
P&S PLUGTAIL® TESTER	
PTTESTER	Red PlugTail Tester for Receptacles and Tails

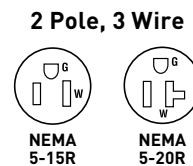

HOSPITAL GRADE DEVICES

Extra Heavy-Duty Receptacles 15 & 20A, 125V; 20A, 250V

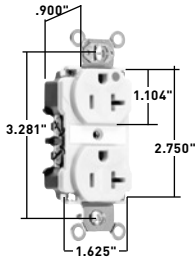

8300I

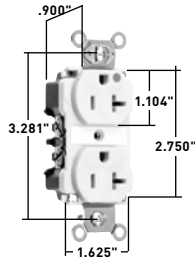

8300ILI

Features

- One-piece nickel-plated brass mounting strap with integral ground.
- Strap tabs wrap around and lock down on face to prevent strap from separating from face and back body.
- Two drive screws anchor strap to back body and face.
- Patented feature, circuit label on face allows permanent circuit identification.
- .040 inch thick, nickel-plated brass, triple-wipe power contacts for lasting retention.
- Easily accessed break-off, line-contact connecting tab for fast, easy split circuit wiring.
- Impact-resistant nylon face and back body.
- Oversized #10 deep tri-drive head brass terminal and ground screws.
- Patented feature, external screw-pressure-plate back wire clamp on ground terminal for faster, easier installation.
- External nickel-plated screw-pressure-plate back wire clamps with #10 brass terminal screws for visual assurance of a good connection.
- Line terminals accept #14 - #10 AWG stranded or solid copper clad conductors.
- Auto-ground clip assures positive ground.
- Illuminated version features exclusive LED lamp with solder connection for long durable life (10-12 years).

CATALOG NUMBER	RATING		COLOR	NEMA CONFIG. NO.	3rd PARTY COMPLIANCE		
	A.	V.			UL498	FSUL WC596	C22.2 No. 42
DUPLEX RECEPTACLES BACK & SIDE WIRE							
8200I	15	125	Ivory	5-15R	•	•	•
8200W	15	125	White	5-15R	•	•	•
8200	15	125	Brown	5-15R	•	•	•
8200GRY	15	125	Gray	5-15R	•	•	•
8200BK	15	125	Black	5-15R	•	•	•
8200RED	15	125	Red	5-15R	•	•	•
8200LA	15	125	Light Almond	5-15R	•	•	•
8300I	20	125	Ivory	5-20R	•	•	•
8300W	20	125	White	5-20R	•	•	•
8300	20	125	Brown	5-20R	•	•	•
8300GRY	20	125	Gray	5-20R	•	•	•
8300BK	20	125	Black	5-20R	•	•	•
8300RED	20	125	Red	5-20R	•	•	•
8300LA	20	125	Light Almond	5-20R	•	•	•
8800I	20	250	Ivory	6-20R	•	•	•
8800W	20	250	White	6-20R	•	•	•
8800	20	250	Brown	6-20R	•	•	•
8800GRY	20	250	Gray	6-20R	•	•	•
8800BK	20	250	Black	6-20R	•	•	•
8800LA	20	250	Light Almond	6-20R	•	•	•
8800RED	20	250	Red	6-20R	•	•	•
LED ILLUMINATED FACE DUPLEX RECEPTACLES BACK & SIDE WIRE							
8200ILI	15	125	Ivory	5-15R	•	•	•
8200ILW	15	125	White	5-15R	•	•	•
8200ILRED	15	125	Red	5-15R	•	•	•
8300ILI	20	125	Ivory	5-20R	•	•	•
8300ILW	20	125	White	5-20R	•	•	•
8300ILGRY	20	125	Gray	5-20R	•	•	•
8300ILRED	20	125	Red	5-20R	•	•	•
8300ILLA	20	125	Light Almond	5-20R	•	•	•

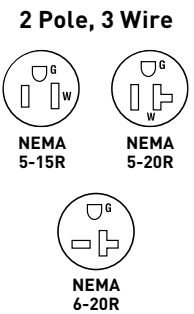

For Bulk Packaging Solutions consult factory.

All devices listed on this page conform to NEMA WD-1 and WD-6.

HOSPITAL GRADE DEVICES

Extra Heavy-Duty MRI Receptacles 15 & 20A, 125V

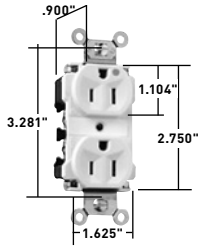

Receptacles designed expressly for MRI applications – We build these exclusive P&S receptacles with non-ferrous metal, so they are perfect for high-magnetic-field environments such as magnetic-resonance imaging (MRI) suites. With the same basic design as our standard Extra Heavy-Duty Receptacles, they are extremely durable.

8200LAMRI

Features

- Patented feature, circuit label on face allows permanent circuit identification.
- Extra heavy-duty, one-piece nickel-plated brass mounting strap with integral ground for superior structural integrity and long-term performance.
- .036 inch thick, brass, triple-wipe power contacts for lasting retention.
- Strap tabs wrap around and lock down on face to prevent strap from separating from and back body.
- Easily accessed break-off, line-contact connecting tab for fast, easy split-circuit wiring.
- Patented feature, external screw-pressure-plate back wire clamp on ground terminal for faster, easier installation.
- External screw-pressure-plate back wire clamps with #10 brass terminal screws for visual assurance of a good connection.
- Auto-ground clip assures positive ground.

CATALOG NUMBER	RATING		COLOR	NEMA CONFIG. NO.	3rd PARTY COMPLIANCE		
	A.	V.			UL498	FSUL WC596	C22.2 No. 42
DUPLIX RECEPTACLES BACK & SIDE WIRE							
8200WMRI	15	125	White	5-15R	•	•	•
8200REDMRI	15	125	Red	5-15R	•	•	•
8200LAMRI	15	125	Light Almond	5-15R	•	•	•
8300IMRI	20	125	Ivory	5-20R	•	•	•
8300WMRI	20	125	White	5-20R	•	•	•
8300GRYMRI	20	125	Gray	5-20R	•	•	•
8300REDMRI	20	125	Red	5-20R	•	•	•
8300LAMRI	20	125	Light Almond	5-20R	•	•	•

2 Pole, 3 Wire

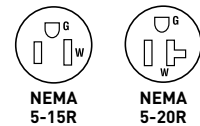

For Bulk Packaging Solutions consult factory.

HOSPITAL GRADE DEVICES

Standard and Smooth-Face Heavy-Duty Receptacles 15 & 20A, 125V

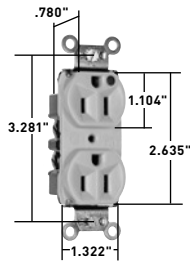

PS8200HI

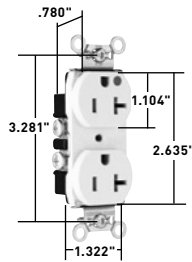

PS8300HSLA

Features

- Heavy-duty, brass strap for added strength and ground conductivity.
- .032 inch thick, brass, triple-wipe power contacts for lasting retention.
- Strap tabs wrap around face to prevent strap from separating from face and back body.
- Easily accessed break-off, line-contact connecting tab for fast, easy split-circuit wiring.
- Two drive screws anchor strap to back body and face.
- Tri-drive brass terminal screws. Internal screw-pressure-plate back and side wire capability. Two back wire holes for more wiring flexibility.
- Auto-ground clip assures positive ground.

CATALOG NUMBER STANDARD	CATALOG NUMBER SMOOTH FACE	RATING		COLOR	NEMA CONFIG. NO.	3rd PARTY COMPLIANCE		
		A.	V.			UL498	FSUL WC596	C22.2 No. 42
DUPLIX RECEPTACLES BACK & SIDE WIRE								
PS8200HI	PS8200HSI	15	125	Ivory	5-15R	•	•	•
PS8200HW	PS8200HSW	15	125	White	5-15R	•	•	•
PS8200H	PS8200HS	15	125	Brown	5-15R	•	•	•
PS8200HGRY	PS8200HSGRY	15	125	Gray	5-15R	•	•	•
PS8200HRED	PS8200HSRED	15	125	Red	5-15R	•	•	•
PS8200HLA	PS8200HSLA	15	125	Light Almond	5-15R	•	•	•
PS8300HI	PS8300HSI	20	125	Ivory	5-20R	•	•	•
PS8300HW	PS8300HSW	20	125	White	5-20R	•	•	•
PS8300H	PS8300HS	20	125	Brown	5-20R	•	•	•
PS8300HGRY	PS8300HSGRY	20	125	Gray	5-20R	•	•	•
PS8300HRED	PS8300HSRED	20	125	Red	5-20R	•	•	•
PS8300HLA	PS8300HSLA	20	125	Light Almond	5-20R	•	•	•

For Bulk Packaging Solutions consult factory.

2 Pole, 3 Wire



NEMA 5-15R



NEMA 5-20R

HOSPITAL GRADE DEVICES

Heavy-Duty Compact Design Receptacles 15 & 20A, 125V; 20A, 250V

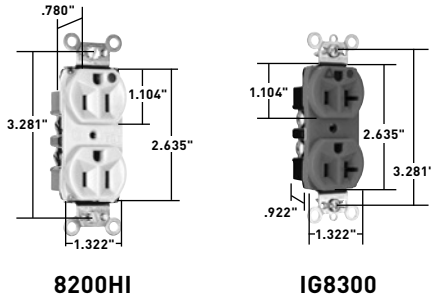

Features

- Impact-resistant nylon face.
- One-piece heat-treated triple-wipe brass power contacts.
- Easily accessible break-off line contact connecting tab for split circuit wiring.
- Terminal compartments isolated from each other for positive conductor containment.
- Corrosion-resistant, zinc-plated steel strap is locked in.
- Internal screw-pressure-plate back wire and side wire line terminals accept #14 -#10 AWG copper or copper-clad conductors.
- High strength thermoplastic back body.
- Back wire holes allow entry of conductor insulation partially into body but not into wiring compartment.
- Auto-ground clip assures positive ground.
- Compact design for easy installation.
- Tri-drive terminal and mounting screws.

CATALOG NUMBER	RATING		COLOR	NEMA CONFIG. NO.	3rd PARTY COMPLIANCE		
	A.	V.			UL498	FSUL WC596	C22.2 No. 42
DUPLIX RECEPTACLES - COMPACT DESIGN BACK & SIDE WIRE							
8200HI	15	125	Ivory	5-15R	•	•	•
8200HW	15	125	White	5-15R	•	•	•
8200H	15	125	Brown	5-15R	•	•	•
8200HGRY	15	125	Gray	5-15R	•	•	•
8200HRED	15	125	Red	5-15R	•	•	•
8200HLA	15	125	Light Almond	5-15R	•	•	•
8300HI	20	125	Ivory	5-20R	•	•	•
8300HW	20	125	White	5-20R	•	•	•
8300H	20	125	Brown	5-20R	•	•	•
8300HGRY	20	125	Gray	5-20R	•	•	•
8300HBK	20	125	Black	5-20R	•	•	•
8300HRED	20	125	Red	5-20R	•	•	•
8300HLA	20	125	Light Almond	5-20R	•	•	•
8300HOR	20	125	Orange	5-20R	•	•	•
ISOLATED GROUND DUPLEX RECEPTACLES BACK & SIDE WIRE							
IG8200I	15	125	Ivory	5-15R	•	•	•
IG8200	15	125	Orange	5-15R	•	•	•
IG8200RED	15	125	Red	5-15R	•	•	•
IG8300I	20	125	Ivory	5-20R	•	•	•
IG8300W	20	125	White	5-20R	•	•	•
IG8300	20	125	Orange	5-20R	•	•	•
IG8300RED	20	125	Red	5-20R	•	•	•
IG8300LA	20	125	Light Almond	5-20R	•	•	•
IG8800	20	250	Orange	6-20R	•	•	•
IG8800LA	20	250	Light Almond	6-20R	•	•	•

2 Pole, 3 Wire

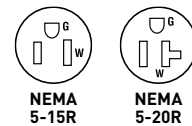

For Bulk Packaging Solutions consult factory.

HOSPITAL GRADE DEVICES

PlugTail® Specification Grade Receptacles 15 & 20A, 125V

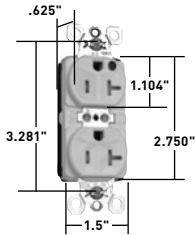

PTTR8300W

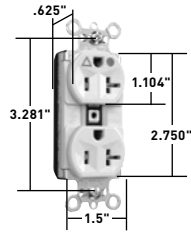

PTIG8300I

Features

- Dual mechanical shutter system to help prevent insertion of foreign objects.
- .036 inch thick, brass, triple-wipe power contacts for lasting retention.
- Plated steel wrap strap design for maximum durability and corrosion resistance.
- No exposed terminals create a finger safe application before, during, and after installation.
- Built-in connector features large brass terminal blades to ensure consistent, reliable electrical connections.
- Crimped and welded contacts.
- Ultrasonically welded polycarbonate connector housing secures terminations and conductors in a UL Listed, finger safe housing.
- Large brass contacts snugly terminate on device blade terminals.
- Pre-stripped connector leads fasten to conductors, easier than standard pigtailed.
- Auto-ground clip assures positive ground.

CATALOG NUMBER	RATING		COLOR	NEMA CONFIG. NO.	3rd PARTY COMPLIANCE	
	A.	V.			UL498	FSUL WC596
TAMPER-RESISTANT DUPLEX RECEPTACLES						
PTTR8200I	15	125	Ivory	5-15R	•	•
PTTR8200W	15	125	White	5-15R	•	•
PTTR8200RED	15	125	Red	5-15R	•	•
PTTR8300I	20	125	Ivory	5-20R	•	•
PTTR8300W	20	125	White	5-20R	•	•
PTTR8300	20	125	Brown	5-20R	•	•
PTTR8300GRY	20	125	Gray	5-20R	•	•
PTTR8300BK	20	125	Black	5-20R	•	•
PTTR8300RED	20	125	Red	5-20R	•	•
PTTR8300LA	20	125	Light Almond	5-20R	•	•

2 Pole, 3 Wire

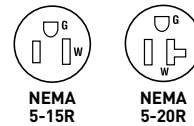

For PlugTail Connectors, see Page E-18.

Features

- .036 inch thick, brass, triple-wipe power contacts for lasting retention.
- Plated steel wrap strap design for maximum durability and corrosion resistance.
- No exposed terminals create a finger safe application before, during, and after installation.
- Built-in connector features large brass terminal blades to ensure consistent, reliable electrical connections.
- Ultrasonically welded polycarbonate connector housing secures terminations and conductors in a UL Listed, finger safe housing.
- Crimped and welded contacts.
- Large brass contacts snugly terminate on device blade terminals.
- Pre-stripped connector leads fasten to conductors, easier than standard pigtailed.
- Auto-ground clip assures positive ground.
- Features a plastic barrier that isolates grounding terminal from mounting strap and metal boxes.

CATALOG NUMBER	RATING		COLOR	NEMA CONFIG. NO.	3rd PARTY COMPLIANCE	
	A.	V.			UL498	FSUL WC596
ISOLATED GROUND DUPLEX RECEPTACLES						
PTIG8200	15	125	Orange	5-15R	•	•
PTIG8200RED	15	125	Red	5-15R	•	•
PTIG8300I	20	125	Ivory	5-20R	•	•
PTIG8300	20	125	Orange	5-20R	•	•
PTIG8300RED	20	125	Red	5-20R	•	•

For Bulk Packaging Solutions consult factory.

All devices listed on this page conform to NEMA WD-1 and WD-6.

HOSPITAL GRADE DEVICES

PlugTail® Specification Grade Receptacles 15 & 20A, 125V

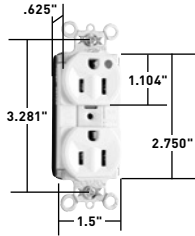

PT8200HW

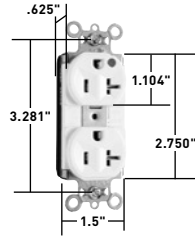

PT8300HW

Features

- .036 inch thick, brass, triple-wipe power contacts for lasting retention.
- Zinc-plated steel strap for added strength & ground conductivity.
- No exposed terminals before, during or after installation increases safety at all phases of product life.
- Built-in connector features large brass terminal blades to ensure consistent, reliable electrical connections.
- Ultrasonically welded polycarbonate connector housing secures terminations and conductors in a UL Listed, finger-safe housing.
- Large brass contacts snugly terminate on device blade terminals. Audible snapping latch assures connection, allows release.
- Pre-stripped connector leads fasten to conductors, easier than standard pigtails.
- Auto-ground clip assures positive ground.

CATALOG NUMBER	RATING		COLOR	NEMA CONFIG. NO.	3rd PARTY COMPLIANCE		
	A.	V.			cUL ^{us} UL498	FSUL WC596	CSA C22.2 No. 42
HEAVY-DUTY COMPACT DESIGN DUPLEX RECEPTACLES							
PT8200HI	15	125	Ivory	5-15R	•	•	•
PT8200HW	15	125	White	5-15R	•	•	•
PT8200HGRY	15	125	Gray	5-15R	•	•	•
PT8200HRED	15	125	Red	5-15R	•	•	•
PT8200HLA	15	125	Light Almond	5-15R	•	•	•
PT8300HI	20	125	Ivory	5-20R	•	•	•
PT8300HW	20	125	White	5-20R	•	•	•
PT8300H	20	125	Brown	5-20R	•	•	•
PT8300HGRY	20	125	Gray	5-20R	•	•	•
PT8300HBK	20	125	Black	5-20R	•	•	•
PT8300HRED	20	125	Red	5-20R	•	•	•
PT8300HLA	20	125	Light Almond	5-20R	•	•	•

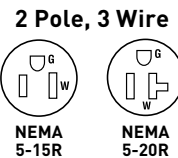

For PlugTail Connectors, see Page E-18.

HOSPITAL GRADE DEVICES

Single Receptacles 15 & 20A, 125V; 20A, 250V

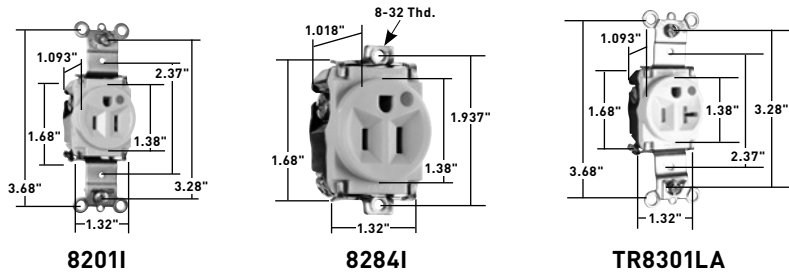

CATALOG NUMBER	RATING		COLOR	NEMA CONFIG. NO.	3rd PARTY COMPLIANCE		
	A.	V.			cULus UL943	FSUL WC596	cUL/CSA
SINGLE RECEPTACLES BACK & SIDE WIRE							
8201I	15	125	Ivory	5-15R	•	•	•
8201W	15	125	White	5-15R	•	•	•
8201	15	125	Brown	5-15R	•	•	•
8201GRY	15	125	Gray	5-15R	•	•	•
8201BK	15	125	Black	5-15R	•	•	•
8201RED	15	125	Red	5-15R	•	•	•
8201LA	15	125	Light Almond	5-15R	•	•	•
8301I	20	125	Ivory	5-20R	•	•	•
8301W	20	125	White	5-20R	•	•	•
8301	20	125	Brown	5-20R	•	•	•
8301GRY	20	125	Gray	5-20R	•	•	•
8301RED	20	125	Red	5-20R	•	•	•
8301LA	20	125	Light Almond	5-20R	•	•	•
8801I	20	250	Ivory	6-20R	•	•	•
8801W	20	250	White	6-20R	•	•	•
8801	20	250	Brown	6-20R	•	•	•
8801GRY	20	250	Gray	6-20R	•	•	•
8801RED	20	250	Red	6-20R	•	•	•
8801LA	20	250	Light Almond	6-20R	•	•	•
TAMPER-RESISTANT SINGLE RECEPTACLES BACK & SIDE WIRE							
TR8201I	15	125	Ivory	5-15R	•	•	•
TR8201W	15	125	White	5-15R	•	•	•
TR8201	15	125	Brown	5-15R	•	•	•
TR8201GRY	15	125	Gray	5-15R	•	•	•
TR8201BK	15	125	Black	5-15R	•	•	•
TR8201RED	15	125	Red	5-15R	•	•	•
TR8201LA	15	125	Light Almond	5-15R	•	•	•
TR8301I	20	125	Ivory	5-20R	•	•	•
TR8301W	20	125	White	5-20R	•	•	•
TR8301	20	125	Brown	5-20R	•	•	•
TR8301BK	20	125	Black	5-20R	•	•	•
TR8301RED	20	125	Red	5-20R	•	•	•
TR8301LA	20	125	Light Almond	5-20R	•	•	•
SHORT STRAP SINGLE RECEPTACLES 1.937" SCREW SPACING, BACK & SIDE WIRE							
8284I	15	125	Ivory	5-15R	•	•	•
8284	15	125	Brown	5-15R	•	•	•
8384I	20	125	Ivory	5-20R	•	•	•
8384	20	125	Brown	5-20R	•	•	•

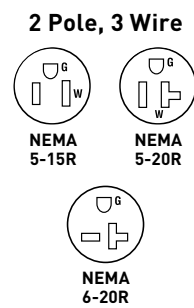

For Hospital Use Power Interrupting Device consult Turnlok® Section H.

For Bulk Packaging Solutions consult factory.

All devices listed on this page conform to NEMA WD-1 and WD-6.

HOSPITAL GRADE DEVICES

Duplex and Heavy-Duty Hospital Grade Tamper-Resistant Compact Receptacles 15 & 20A, 125V

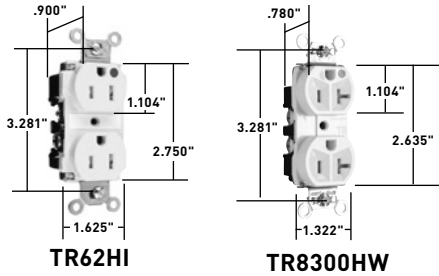

Features

- Thermoplastic dual mechanism shutter system to help prevent insertion of foreign objects.
- Patented feature, circuit label on face allows permanent circuit identification.
- Extra heavy-duty brass, one-piece mounting strap with integral ground.
- One-piece, nickel-plated brass, triple-wipe power contacts for lasting retention.
- Strap tabs wrap around and lock down on face to prevent strap from separating from face and back body.
- Impact-resistant nylon face and back body.
- Easily accessed break-off, line-contact connecting tab for fast, easy split-circuit wiring.
- Two drive screws anchor strap to back body and face.
- Patented feature, external screw-pressure-plate back wire clamp on ground terminal for faster, easier installation.
- External screw-pressure-plate back wire clamps with #10 brass terminal screws for visual assurance of a good connection.
- Auto-ground clip assures positive ground.

CATALOG NUMBER	RATING		COLOR	NEMA CONFIG. NO.	3rd PARTY COMPLIANCE		
	A.	V.			UL943	FSUL WC596	C22.2 No. 42
DUPLEX RECEPTACLES BACK & SIDE WIRE							
TR62HI	15	125	Ivory	5-15R	•	•	•
TR62HW	15	125	White	5-15R	•	•	•
TR62H	15	125	Brown	5-15R	•	•	•
TR62HGRY	15	125	Gray	5-15R	•	•	•
TR62HRED	15	125	Red	5-15R	•	•	•
TR62HLA	15	125	Light Almond	5-15R	•	•	•
TR63HI	20	125	Ivory	5-20R	•	•	•
TR63HW	20	125	White	5-20R	•	•	•
TR63H	20	125	Brown	5-20R	•	•	•
TR63HGRY	20	125	Gray	5-20R	•	•	•
TR63HRED	20	125	Red	5-20R	•	•	•
TR63HLA	20	125	Light Almond	5-20R	•	•	•
TR63HBL	20	125	Blue	5-20R	•	•	•

CATALOG NUMBER	RATING		COLOR	NEMA CONFIG. NO.	3rd PARTY COMPLIANCE		
	A.	V.			UL498	FSUL WC596	C22.2 No. 42
HOSPITAL GRADE TAMPER-RESISTANT DUPLEX RECEPTACLES BACK AND SIDE WIRE							
TR8200HI	15	125	Ivory	5-15R	•	•	•
TR8200HW	15	125	White	5-15R	•	•	•
TR8200H	15	125	Brown	5-15R	•	•	•
TR8200HGRY	15	125	Gray	5-15R	•	•	•
TR8200HRED	15	125	Red	5-15R	•	•	•
TR8200HLA	15	125	Light Almond	5-15R	•	•	•
TR8300HI	20	125	Ivory	5-20R	•	•	•
TR8300HW	20	125	White	5-20R	•	•	•
TR8300H	20	125	Brown	5-20R	•	•	•
TR8300HGRY	20	125	Gray	5-20R	•	•	•
TR8300HRED	20	125	Red	5-20R	•	•	•
TR8300HLA	20	125	Light Almond	5-20R	•	•	•

2 Pole, 3 Wire

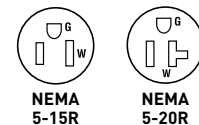

For PlugTail® Tamper-Resistant Receptacles, see Pages E-4 and E-11.

For Bulk Packaging Solutions consult factory.

All devices listed on this page conform to NEMA WD-1 and WD-6.

HOSPITAL GRADE DEVICES

Hospital Grade Tamper-Resistant Power Indicating Receptacles 15 & 20A, 125V

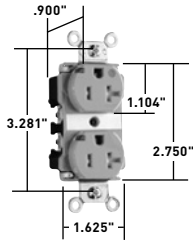

TR8300PIGRY

Features

- Exclusive, wrap-around green LEDs offer clear visual assurance of power indication at the receptacle.
- Thermoplastic dual mechanism shutter system to help prevent insertion of foreign objects.
- Patented feature, circuit label on face allows permanent circuit identification.
- Extra heavy-duty brass, one-piece mounting strap with integral ground.
- One-piece, nickel-plated brass, triple-wipe power contacts for lasting retention.
- Strap tabs wrap around and lock down on face to prevent strap from separating from face and back body.
- Impact-resistant nylon face and back body.
- Easily accessed break-off, line-contact connecting tab for fast, easy split-circuit wiring.
- Two drive screws anchor strap to back body and face.
- Patented feature, external screw-pressure-plate back wire clamp on ground terminal for faster, easier installation.
- External screw-pressure-plate back wire clamps with #10 brass terminal screws for visual assurance of a good connection.
- Auto-ground clip assures positive ground.

CATALOG NUMBER	RATING		COLOR	NEMA CONFIG. NO.	3rd PARTY COMPLIANCE		
	A.	V.			UL498	FSUL WC596	C22.2 No. 42
POWER-INDICATING TAMPER-RESISTANT HEAVY-DUTY DUPLEX RECEPTACLES							
TR8200HPI	15	125	Brown	5-15R	•	•	•
TR8200HPIW	15	125	White	5-15R	•	•	•
TR8200HPILA	15	125	Light Almond	5-15R	•	•	•
TR8200HPII	15	125	Ivory	5-15R	•	•	•
TR8200HPIRED	15	125	Red	5-15R	•	•	•
TR8200HPIGRY	15	125	Gray	5-15R	•	•	•
TR8300HPI	20	125	Brown	5-20R	•	•	•
TR8300HPIW	20	125	White	5-20R	•	•	•
TR8300HPILA	20	125	Light Almond	5-20R	•	•	•
TR8300HPII	20	125	Ivory	5-20R	•	•	•
TR8300HPIRED	20	125	Red	5-20R	•	•	•
TR8300HPIGRY	20	125	Gray	5-20R	•	•	•
POWER-INDICATING TAMPER-RESISTANT EXTRA HEAVY-DUTY DUPLEX RECEPTACLES							
TR8200PI	15A	125V	Brown	5-15R	•	•	•
TR8200PIW	15A	125V	White	5-15R	•	•	•
TR8200PILA	15A	125V	Light Almond	5-15R	•	•	•
TR8200PII	15A	125V	Ivory	5-15R	•	•	•
TR8200PIRED	15A	125V	Red	5-15R	•	•	•
TR8200PIGRY	15A	125V	Gray	5-15R	•	•	•
TR8300PI	20A	125V	Brown	5-20R	•	•	•
TR8300PIW	20A	125V	White	5-20R	•	•	•
TR8300PILA	20A	125V	Light Almond	5-20R	•	•	•
TR8300PII	20A	125V	Ivory	5-20R	•	•	•
TR8300PIRED	20A	125V	Red	5-20R	•	•	•
TR8300PIGRY	20A	125V	Gray	5-20R	•	•	•

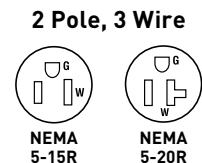

For PlugTail® Tamper-Resistant Receptacles, see Pages E-4 and E-11.

All devices listed on this page conform to NEMA WD-1 and WD-6.

HOSPITAL GRADE DEVICES

Isolated Ground Receptacles 15 & 20A, 125; 20A, 250V

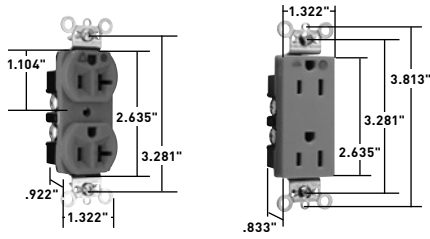

IG8300

IG26262HG

CATALOG NUMBER	RATING		COLOR	NEMA CONFIG. NO.	3rd PARTY COMPLIANCE		
	A.	V.			UL498	FSUL WC596	C22.2 No. 42
DUPLEX RECEPTACLES BACK & SIDE WIRE							
IG8200I	15	125	Ivory	5-15R	•	•	•
IG8200	15	125	Orange	5-15R	•	•	•
IG8200RED	15	125	Red	5-15R	•	•	•
IG8300I	20	125	Ivory	5-20R	•	•	•
IG8300W	20	125	White	5-20R	•	•	•
IG8300	20	125	Orange	5-20R	•	•	•
IG8300RED	20	125	Red	5-20R	•	•	•
IG8300LA	20	125	Light Almond	5-20R	•	•	•
IG8800	20	250	Orange	6-20R	•	•	•
IG8800LA	20	250	Light Almond	6-20R	•	•	•
DECORATOR DUPLEX RECEPTACLES BACK & SIDE WIRE							
IG26262HGW	15	125	White	5-15R	•	•	•
IG26262HG	15	125	Orange	5-15R	•	•	•
IG26262HGREDD	15	125	Red	5-15R	•	•	•
IG26362HGW	20	125	White	5-20R	•	•	•
IG26362HG	20	125	Orange	5-20R	•	•	•
IG26362HGBK	20	125	Black	5-20R	•	•	•
IG26362HGREDD	20	125	Red	5-20R	•	•	•
SINGLE RECEPTACLES BACK & SIDE WIRE							
IG8301	20	125	Orange	5-20R	•	•	•

2 Pole, 3 Wire

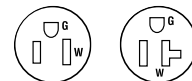

NEMA 5-15R NEMA 5-20R



NEMA 6-20R

For Wall Plates for Isolated Ground Systems, consult Wall Plates Section S.

For Bulk Packaging Solutions consult factory.

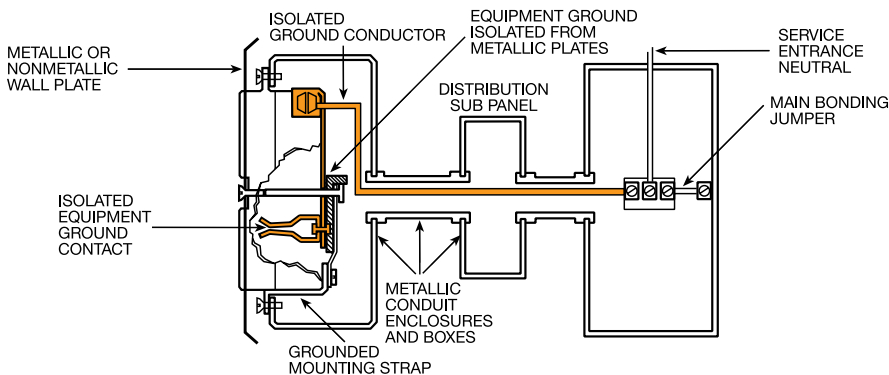

HOSPITAL GRADE DEVICES

Tamper-Resistant Isolated Ground Receptacles 15 & 20A, 125V

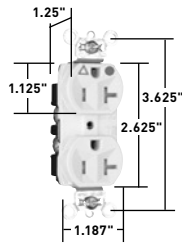

TRIG8300W

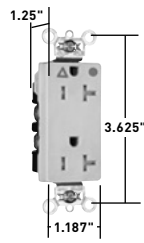

TRIG26362HG

CATALOG NUMBER	RATING		COLOR	NEMA CONFIG. NO.	3rd PARTY COMPLIANCE	
	A.	V.			UL498	FSUL WC596
TAMPER-RESISTANT DUPLEX RECEPTACLES BACK & SIDE WIRE						
TRIG8200I	15	125	Ivory	5-15R	•	•
TRIG8200W	15	125	White	5-15R	•	•
TRIG8200	15	125	Orange	5-15R	•	•
TRIG8200BK	15	125	Black	5-15R	•	•
TRIG8200GRY	15	125	Gray	5-15R	•	•
TRIG8200RED	15	125	Red	5-15R	•	•
TRIG8200LA	15	125	Light Almond	5-15R	•	•
TRIG8300I	20	125	Ivory	5-20R	•	•
TRIG8300W	20	125	White	5-20R	•	•
TRIG8300	20	125	Orange	5-20R	•	•
TRIG8300BK	20	125	Black	5-20R	•	•
TRIG8300GRY	20	125	Gray	5-20R	•	•
TRIG8300RED	20	125	Red	5-20R	•	•
TRIG8300LA	20	125	Light Almond	5-20R	•	•
TAMPER-RESISTANT DECORATOR RECEPTACLES BACK & SIDE WIRE						
TRIG26262HGI	15	125	Ivory	5-15R	•	•
TRIG26262HGW	15	125	White	5-15R	•	•
TRIG26262HGBK	15	125	Black	5-15R	•	•
TRIG26262HGGRY	15	125	Gray	5-15R	•	•
TRIG26262HGRED	15	125	Red	5-15R	•	•
TRIG26262HGCLA	15	125	Light Almond	5-15R	•	•
TRIG26362HGI	20	125	Ivory	5-20R	•	•
TRIG26362HGW	20	125	White	5-20R	•	•
TRIG26362HG	20	125	Orange	5-20R	•	•
TRIG26362HGBK	20	125	Black	5-20R	•	•
TRIG26362HGGRY	20	125	Gray	5-20R	•	•
TRIG26362HGRED	20	125	Red	5-20R	•	•
TRIG26362HGCLA	20	125	Light Almond	5-20R	•	•

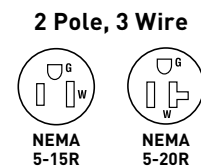

For Bulk Packaging Solutions consult factory.

HOSPITAL GRADE DEVICES

PlugTail® Decorator Receptacles 15 & 20A, 125V

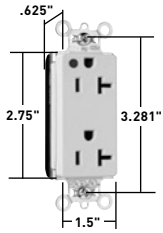

PT26362HGI



PTRA6STR

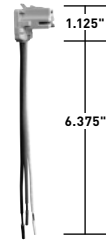

PTRA6STRBP



PTRA6STRG

Features

- .036 inch thick, brass, triple-wipe power contacts for lasting retention.
- Plated steel wrap strap design for maximum durability and corrosion resistance.
- No exposed terminals create a finger safe application before, during, and after installation.
- Built-in connector features large brass terminal blades to ensure consistent, reliable electrical connections.
- Crimped and welded contacts.
- Ultrasonically welded polycarbonate connector housing secures terminations and conductors in a UL Listed, finger safe housing.
- Large brass contacts snugly terminate on device blade terminals.
- Pre-stripped connector leads fasten to conductors, easier than standard pigtails.
- Auto-ground clip assures positive ground.

CATALOG NUMBER	RATING		COLOR	NEMA CONFIG. NO.	3rd PARTY COMPLIANCE	
	A.	V.			UL498	FSUL WC596
DUPLIX RECEPTACLES						
PT26262HGI	15	125	Ivory	5-15R	•	•
PT26262HGW	15	125	White	5-15R	•	•
PT26262HGRED	15	125	Red	5-15R	•	
PT26362HGI	20	125	Ivory	5-20R	•	
PT26362HGW	20	125	White	5-20R	•	
PT26362HGGRY	20	125	Gray	5-20R	•	
PT26362HGRED	20	125	Red	5-20R	•	
PT26362HGLA	20	125	Light Almond	5-20R	•	

For PlugTail Connector catalog numbers, see below.

2 Pole, 3 Wire

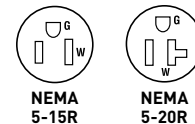

CATALOG NUMBER	WIRE TYPE	WIRE LENGTH
PLUGTAIL CONNECTORS – RIGHT ANGLE		
PTRA6SOL	Solid	6"
PTRA6STR	Stranded	6"
PTRA6SOLB25	Solid	25"
PTRA6STRB25	Stranded	25"
NAFTA-COMPLIANT PLUGTAIL CONNECTORS – RIGHT ANGLE		
PTRA6SOLNA	Solid	6"
PTRA6STRNA	Stranded	6"
PLUGTAIL CONNECTORS – RIGHT ANGLE WITH WAGO CONNECTORS		
PTRA6SOLBP	Solid	6"
PTRA6STRBP	Stranded	6"
PLUGTAIL CONNECTORS – RIGHT ANGLE WITH GROUND SCREW		
PTRA6SOLG	Solid	6"
PTRA6STRG	Stranded	6"

For Bulk Packaging Solutions consult factory.

NAFTA-Compliant PlugTail Connectors are ideal for use on projects subject to the provisions of the Buy American Act.

All devices listed on this page conform to NEMA WD-1 and WD-6.

HOSPITAL GRADE DEVICES

Heavy-Duty Decorator Receptacles 15 & 20A, 125V

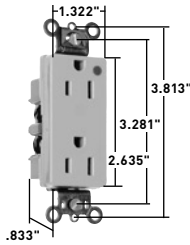

26262HGI

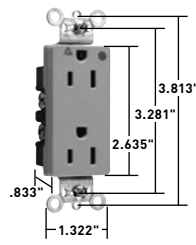

IG26262HG0

Features

- Corrosion-resistant, plated steel strap locked into assembly to prohibit strap bending away from body.
- One-piece, brass, triple-wipe power contacts for lasting retention.
- Heavy-duty compact design for easier installation and long lasting performance.
- Easily accessed break-off, line-contact connecting tab for fast, easy split-circuit wiring.
- Impact-resistant nylon face.
- Terminal compartments isolated from each other for positive conductor containment.
- Side and internal screw-pressure-plate back wire accepts #14-#10 AWG solid or stranded wire.
- All devices fit standard #26 opening wall plate.
- Tri-drive terminal and mounting screws.
- Auto-ground clip assures positive ground.

CATALOG NUMBER	RATING		COLOR	NEMA CONFIG. NO.	3rd PARTY COMPLIANCE		
	A.	V.			UL498	cUL/CSA	FSUL WC596
DUPLEX RECEPTACLES BACK & SIDE WIRE							
26262HGI	15	125	Ivory	5-15R	•	•	•
26262HGW	15	125	White	5-15R	•	•	•
26262HGGRY	15	125	Gray	5-15R	•	•	•
26262HGRED	15	125	Red	5-15R	•	•	•
26362HGI	20	125	Ivory	5-20R	•	•	•
26362HGW	20	125	White	5-20R	•	•	•
26362HG	20	125	Brown	5-20R	•	•	•
26362HGGRY	20	125	Gray	5-20R	•	•	•
26362HGRED	20	125	Red	5-20R	•	•	•
26362HGLA	20	125	Light Almond	5-20R	•	•	•
ISOLATED GROUND DUPLEX RECEPTACLES BACK & SIDE WIRE							
IG26262HGW	15	125	White	5-15R	•	•	
IG26262HG	15	125	Orange	5-15R	•	•	
IG26262HGRED	15	125	Red	5-15R	•	•	
IG26362HGW	20	125	White	5-20R	•	•	
IG26362HG	20	125	Orange	5-20R	•	•	
IG26362HGBK	20	125	Black	5-20R	•	•	
IG26362HGRED	20	125	Red	5-20R	•	•	

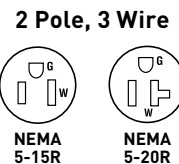

For Bulk Packaging Solutions consult factory.

All devices listed on this page conform to NEMA WD-1 and WD-6.

HOSPITAL GRADE DEVICES

Heavy-Duty Tamper-Resistant & Power Indicating Decorator Receptacles 15 & 20A, 125V

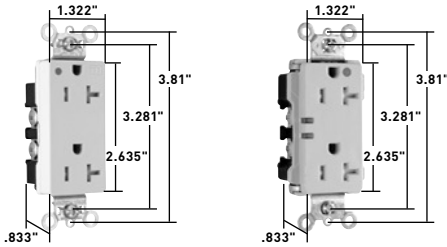

TR26362HGI

TR26362HGPII

Features

- Auto-ground clip assures positive ground.
- Dual mechanical shutter system to help prevent insertion of foreign objects.
- One-piece brass triple-wipe power contacts for reliable plug retention.
- Two drive screws anchor strap to back body and face where abrupt removal torque is strongest.
- Patented external screw-pressure-plate back wire clamp on ground terminal for faster, easier installation.
- Easily accessed break-off, line-contact connecting tab for fast, easy split-circuit wiring.
- External screw-pressure-plate back wire clamps with #10 brass terminal screws for visual assurance of a good connection.
- One-piece plated steel mounting strap with integral ground for superior long-term performance.

CATALOG NUMBER	RATING		COLOR	NEMA CONFIG. NO.	3rd PARTY COMPLIANCE		
	A.	V.			UL498	FSUL WC596	cUL/CSA
TAMPER-RESISTANT DUPLEX RECEPTACLES BACK & SIDE WIRE							
TR26262HGI	15	125	Ivory	5-15R	•	•	•
TR26262HGW	15	125	White	5-15R	•	•	•
TR26262HGGRY	15	125	Gray	5-15R	•	•	•
TR26262HGRED	15	125	Red	5-15R	•	•	•
TR26262HGLA	15	125	Light Almond	5-15R	•	•	•
TR26362HGI	20	125	Ivory	5-20R	•	•	•
TR26362HGW	20	125	White	5-20R	•	•	•
TR26362HGGRY	20	125	Gray	5-20R	•	•	•
TR26362HGBK	20	125	Black	5-20R	•	•	•
TR26362HGRED	20	125	Red	5-20R	•	•	•
TR26362HGLA	20	125	Light Almond	5-20R	•	•	•

CATALOG NUMBER	RATING		COLOR	NEMA CONFIG. NO.	3rd PARTY COMPLIANCE		
	A.	V.			UL498	FSUL WC596	cUL/CSA
POWER-INDICATING TAMPER-RESISTANT DUPLEX RECEPTACLES							
TR26262HGPI	15A	125V	Brown	5-15R	•	•	•
TR26262HGPIW	15A	125V	White	5-15R	•	•	•
TR26262HGPILA	15A	125V	Light Almond	5-15R	•	•	•
TR26262HGPII	15A	125V	Ivory	5-15R	•	•	•
TR26262HGPIRED	15A	125V	Red	5-15R	•	•	•
TR26262HGPIGRY	15A	125V	Grey	5-15R	•	•	•
TR26362HGPI	20A	125V	Brown	5-20R	•	•	•
TR26362HGPIW	20A	125V	White	5-20R	•	•	•
TR26362HGPILA	20A	125V	Light Almond	5-20R	•	•	•
TR26362HGPII	20A	125V	Ivory	5-20R	•	•	•
TR26362HGPIRED	20A	125V	Red	5-20R	•	•	•
TR26362HGPIGRY	20A	125V	Grey	5-20R	•	•	•

2 Pole, 3 Wire

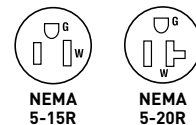

NEMA 5-15R

NEMA 5-20R

For Bulk Packaging Solutions consult factory.

HOSPITAL GRADE DEVICES

HOSPITAL GRADE DEVICES

USB Chargers with Tamper-Resistant Receptacles

2 Pole, 3 Wire Grounding 15 & 20A, 125V & 120V

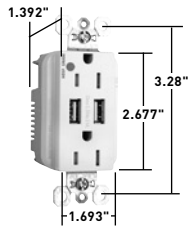

TR8200HUSBLA

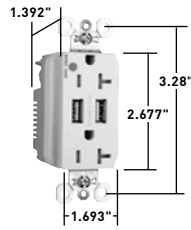

TR8300HUSBLA

Features

- Combination AC duplex receptacles include two 5-volt DC USB ports that work with USB 2.0 & 3.0 compatible devices.
- AC receptacles are tamper-resistant as standard – patented shutter system prevents improper insertion of foreign objects.
- 3.1A total charging capacity.
- Back and side wire terminals accommodate #14 AWG – #10 AWG stranded and solid wire.
- Zinc-plated ground terminal screw.
- Stainless steel auto-ground clip assures positive ground.
- Tamper-Resistant, patented shutter system prevents improper insertion of foreign objects. Meets National Electric Code® Tamper-Resistant requirements.

CATALOG NUMBER	RATING		COLOR	TOTAL CHARGING CAPACITY	NEMA CONFIG. NO.	C22.2 No. 42 C22.2 No. 223	FSUL WC596	UL US UL498 UL1310
	A.	V.						
DUPLEX TAMPER-RESISTANT HOSPITAL GRADE RECEPTACLES WITH USB CHARGER								
TR8200HUSBI	15A	125V	Ivory	3.1 Amp	5-15R	•	•	•
TR8200HUSBW	15A	125V	White	3.1 Amp	5-15R	•	•	•
TR8200HUSB	15A	125V	Brown	3.1 Amp	5-15R	•	•	•
TR8200HUSBGRY	15A	125V	Gray	3.1 Amp	5-15R	•	•	•
TR8200HUSBBK	15A	125V	Black	3.1 Amp	5-15R	•	•	•
TR8200HUSBRED	15A	125V	Red	3.1 Amp	5-15R	•	•	•
TR8300HUSBI	20A	125V	Ivory	3.1 Amp	5-20R	•	•	•
TR8300HUSBW	20A	125V	White	3.1 Amp	5-20R	•	•	•
TR8300HUSB	20A	125V	Brown	3.1 Amp	5-15R	•	•	•
TR8300HUSBBK	20A	125V	Black	3.1 Amp	5-20R	•	•	•
TR8300HUSBGRY	20A	125V	Gray	3.1 Amp	5-20R	•	•	•
TR8300HUSBRED	20A	125V	Red	3.1 Amp	5-20R	•	•	•
TR8300HUSBLA	20A	125V	Light Almond	3.1 Amp	5-20R	•	•	•

2 Pole
3 Wire



NEMA
5-15R



NEMA
5-20R

HOSPITAL GRADE DEVICES

GFCI Receptacles 2 Pole, 3 Wire Grounding 15 & 20A, 125VAC

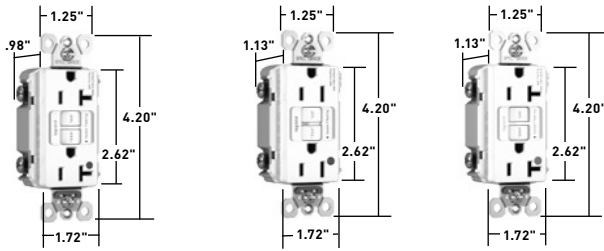

2097HGW

1597HGTRW

2097HGTRW

Features

- SafeLock® Protection: if critical components are damaged and ground fault protection is lost, power to receptacle is disconnected.
- Feed-thru wiring configuration allows GFCI to protect downstream receptacles.
- Prevents line-load reversal miswire: no power to the face or downstream receptacles if wired incorrectly.
- Exceeds UL943 voltage surge requirements; survives 100x the required UL 3kA/6kV voltage surge test cycles.
- FSUL Listed (Federal Specification WC596)
- Trip indicator light (red LED).
- Side or internal screw-pressure-plate back wire with #10-#14 AWG solid or stranded copper wire.
- Two back wire holes per terminal.
- Ground screw has a back wire clamp for easy installation.
- Mounting screws are shipped captive in the device and wall plate for easier installation.
- High-impact-resistant thermoplastic construction.
- Extra-long strap.
- Button colors match the device face.
- Dual-direction test and reset buttons.
- Class A rated GFCI.
- Supplied with matching TP26 nylon wall plate.
- Tri-drive screws.

Tamper-Resistant Models

- Protects children: patented shutter system helps prevent improper insertion of foreign objects.
- Meets National Electrical Code® Tamper-Resistant requirements.

Specifications

- Supply Voltage: 125VAC, 60 Hz
- Supply Voltage Range: 102-132 VAC
- Trio Threshold: 5± 1mA
- Trip Time: 0.025 sec., nominal per UL Standard
- 20 Amp feed-thru capacity

CATALOG NUMBER	RATING		COLOR	NEMA CONFIG. NO.	3rd PARTY COMPLIANCE		
	A.	VAC			UL943 C22.2 No. 144	UL498 C22.2 No. 42	FSUL WC596
TAMPER-RESISTANT 15 AMP DUPLEX GFCI							
1597HGTRI	15	125	Ivory	5-15R	•	•	•
1597HGTRW	15	125	White	5-15R	•	•	•
1597HGTRBK	15	125	Black	5-15R	•	•	•
1597HGTR	15	125	Brown	5-15R	•	•	•
1597HGTRGRY	15	125	Gray	5-15R	•	•	•
1597HGTRRED	15	125	Red	5-15R	•	•	•
1597HGTRLA	15	125	Light Almond	5-15R	•	•	•
TAMPER-RESISTANT 20 AMP DUPLEX GFCI							
2097HGTRI	20	125	Ivory	5-20R	•	•	•
2097HGTRW	20	125	White	5-20R	•	•	•
2097HGTRBK	20	125	Black	5-20R	•	•	•
2097HGTR	20	125	Brown	5-20R	•	•	•
2097HGTRGRY	20	125	Gray	5-20R	•	•	•
2097HGTRRED	20	125	Red	5-20R	•	•	•
2097HGTRLA	20	125	Light Almond	5-20R	•	•	•
15 AMP DUPLEX GFCI							
1597HGI	15	125	Ivory	5-15R	•	•	•
1597HGW	15	125	White	5-15R	•	•	•
1597HGBK	15	125	Black	5-15R	•	•	•
1597HGGRY	15	125	Gray	5-15R	•	•	•
1597HGRED	15	125	Red	5-15R	•	•	•
1597HGCLA	15	125	Light Almond	5-15R	•	•	•
20 AMP DUPLEX GFCI							
2097HGI	20	125	Ivory	5-20R	•	•	•
2097HGW	20	125	White	5-20R	•	•	•
2097HGBK	20	125	Black	5-20R	•	•	•
2097HG	20	125	Brown	5-20R	•	•	•
2097HGGRY	20	125	Gray	5-20R	•	•	•
2097HGRED	20	125	Red	5-20R	•	•	•
2097HGCLA	20	125	Light Almond	5-20R	•	•	•

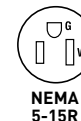

All devices listed on this page conform to NEMA WD-1 and WD-6.

HOSPITAL GRADE DEVICES

Isolated Ground & Audible Alarm Tamper-Resistant GFCI Receptacles

2 Pole, 3 Wire Grounding 15 & 20A, 125VAC

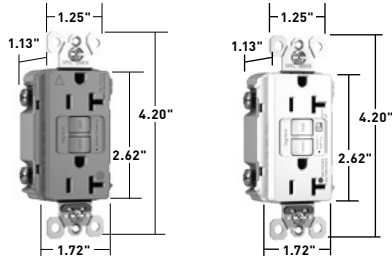

2097IGHGTRO

2097HGTRAW

Features

- SafeLock® Protection: if critical components are damaged and ground fault protection is lost, power to receptacle is disconnected.
- Feed-thru wiring configuration allows GFCI to protect downstream receptacles.
- Prevents line-load reversal miswire: no power to the face or downstream receptacles if wired incorrectly.
- Exceeds UL943 voltage surge requirements; survives 100x the required UL 3kA/6kV voltage surge test cycles.
- Trip indicator light (red LED).
- Side or internal screw-pressure-plate back wire termination speed installation; takes #10-#14 AWG solid or stranded copper or copper-clad conductors.
- Two back wire holes per terminal.
- High-impact-resistant thermoplastic construction.
- Protects children: patented shutter system helps prevent improper insertion of foreign objects.
- Meets National Electrical Code® Tamper-Resistant requirements.

Isolated Ground versions:

- Pre-stripped stranded wire lead for isolated ground termination.
- GFCI Receptacle's grounding system is isolated from the buildings grounding system.

Audible Alarm versions:

- Alarm rated at 60 db at 10 feet.
- Ground terminal back-wire clamp for fast installation.
- Audible Alarm alert of tripped condition. Alarm can be turned on/off.

CATALOG NUMBER	RATING		COLOR	NEMA CONFIG. NO.	3rd PARTY COMPLIANCE		
	A.	VAC			UL943	UL498	FSUL WC596
HOSPITAL GRADE ISOLATED GROUND TAMPER-RESISTANT DUPLEX							
1597IGHGTRO	15	125	Orange	5-15R	•	•	•
2097IGHGTTRI	20	125	Ivory	5-20R	•	•	•
2097IGHGTRW	20	125	White	5-20R	•	•	•
2097IGHGTRGRY	20	125	Gray	5-20R	•	•	•
2097IGHGTRRED	20	125	Red	5-20R	•	•	•
2097IGHGTRLA	20	125	Light Almond	5-20R	•	•	•
2097IGHGTRO	20	125	Orange	5-20R	•	•	•
HOSPITAL GRADE AUDIBLE ALARM TAMPER-RESISTANT DUPLEX GFCI							
1597HGTRA	15	125	Brown	5-15R	•	•	•
1597HGTRAGRY	15	125	Gray	5-15R	•	•	•
1597HGTRALA	15	125	Light Almond	5-15R	•	•	•
2097HGTRAI	20	125	Ivory	5-20R	•	•	•
2097HGTRAW	20	125	White	5-20R	•	•	•
2097HGTRARED	20	125	Red	5-20R	•	•	•
2097HGTRALA	20	125	Light Almond	5-20R	•	•	•

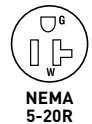
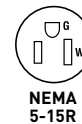

HOSPITAL GRADE DEVICES



Decorator Combination Tamper-Resistant Night Light/GFCI Receptacles

2 Pole, 3 Wire Grounding 15 & 20A, 125VAC

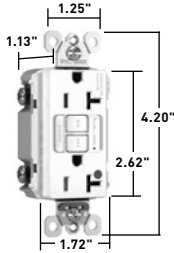

2097HGNTLTRW

Features

- Feed-thru wiring configuration allows GFCI to protect downstream receptacles.
- Protects children: patented shutter system helps prevent improper insertion of foreign objects.
- Meets National Electrical Code® Tamper-Resistant requirements.
- SafeLock® Protection: if critical components are damaged and ground fault protection is lost, power to receptacle is disconnected.
- Sealed nightlight with high impact-resistant Lexan® lens prevents tampering.
- Night Light uses cooler LED illumination.
- Energy-efficient LED has average 20-year life expectancy, eliminating bulb replacement.
- Rated at 186 milliwatts @ 125V.
- Two receptacles.
- Photocell turns nightlight ON is dark, OFF in daylight.
- Prevents line-load reversal miswire: no power to the face or downstream receptacles if wired incorrectly.
- Exceeds UL943 voltage surge requirements; survives 100x the required UL 3kA/6kV voltage surge test cycles.
- FSUL Listed (Federal Specification WC596)
- Trip indicator light (red LED).
- Side or internal screw-pressure-plate back wire with #10-#14 AWG solid or stranded copper wire.
- Two back wire holes per terminal.
- Ground screw has a back wire clamp for easy installation.
- Mounting screws are shipped captive in the device and wall plate for easier installation.
- High-impact-resistant thermoplastic construction.
- Extra-long strap.
- Button colors match the device face.
- Dual-direction test and reset buttons.
- Class A rated GFCI.
- Supplied with matching TP26 nylon wall plate.
- Tri-drive screws.

Specifications

- Supply Voltage: 125VAC, 60 Hz
- Supply Voltage Range: 102-132 VAC
- Trio Threshold: 5± 1mA
- Trip Time: 0.025 sec., nominal per UL Standard
- 20 Amp feed-thru capacity

CATALOG NUMBER	RATING		LIGHT OUTPUT IN 1' FCD*	COLOR	NEMA CONFIG. NO.	3rd PARTY COMPLIANCE		
	A.	VAC				UL943 C22.2 No. 144	UL498 C22.2 No. 42	FSUL WC596
COMBINATION TAMPER-RESISTANT 15 AMP NIGHT LIGHT/GFCI								
1597HGNTLTRI	15	125	0.180	Ivory	5-15R	•	•	•
1597HGNTLTRW	15	125	0.180	White	5-15R	•	•	•
1597HGNTLTR	15	125	0.180	Brown	5-15R	•	•	•
1597HGNTLTRRED	15	125	0.180	Red	5-15R	•	•	•
COMBINATION TAMPER-RESISTANT 20 AMP NIGHT LIGHT/GFCI								
2097HGNTLTRI	20	125	0.180	Ivory	5-20R	•	•	•
2097HGNTLTRW	20	125	0.180	White	5-20R	•	•	•
2097HGNTLTRGRY	20	125	0.180	Gray	5-20R	•	•	•
2097HGNTLTRRED	20	125	0.180	Red	5-20R	•	•	•
2097HGNTLTRLA	20	125	0.180	Light Almond	5-20R	•	•	•



NEMA 5-15R



NEMA 5-20R

*FCD = Foot Candle Distance, 1 Lumen = 1 FCD. See Page U-68 for more information.

HOSPITAL GRADE DEVICES

PlugTail® GFCI Receptacles 2 Pole, 3 Wire Grounding 15 & 20A, 125VAC

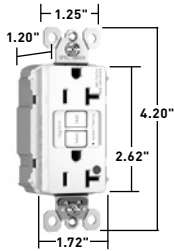

PT2097HGW

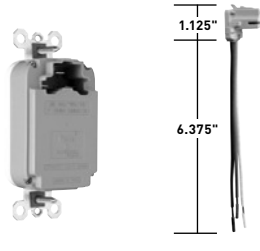

PTRA6STR

Features and Specifications

- Faster, more reliable installation.
- No exposed terminals create a finger safe application before, during, and after installation.
- Built-in connector features large brass terminal blades to ensure consistent, reliable electrical connections to PlugTail Connector.
- GFCI works with the existing 3-wire PlugTail Connectors creating a non-feed-thru application for facility owners. At rough-in just install the same right angle connector for GFCI and receptacle openings.
- SafeLock® Protection: if critical components are damaged and ground fault protection is lost, power to receptacle is disconnected.
- FSUL Listed (Federal Specification WC596)
- Exceeds UL943 surge requirements; survives 100x the required UL 3kA/6kV voltage surge test cycles.
- Trip indicator light (red LED).
- Mounting screws are shipped captive in the device and wall plate for easier installation.
- High-impact-resistant thermoplastic construction.
- Zinc-plated steel mounting strap.
- Button colors match the device face.
- Dual-direction test and reset buttons.
- Class A rated GFCI
- Supplied with matching TP26 nylon wall plate.
- Tri-drive screws.

Specifications

- Supply Voltage: 125VAC, 60 Hz
- Supply Voltage Range: 102-132 VAC
- Trip Threshold: 5± 1mA
- Trip Time: 0.025 sec., nominal per UL Standard
- 20 Amp feed-thru capacity

CATALOG NUMBER	RATING		COLOR	NEMA CONFIG. NO.	3rd PARTY COMPLIANCE		
	A.	VAC			UL943 C22.2 No. 144	UL498 C22.2 No. 42	FSUL WC596
15 AMP DUPLEX GFCI							
PT1597HGI	15	125	Ivory	5-15R	•	•	•
PT1597HGW	15	125	White	5-15R	•	•	•
PT1597HGBK	15	125	Black	5-15R	•	•	•
PT1597HGRED	15	125	Red	5-15R	•	•	•
PT1597HGLA	15	125	Light Almond	5-15R	•	•	•
20 AMP DUPLEX GFCI							
PT2097HGI	20	125	Ivory	5-20R	•	•	•
PT2097HGW	20	125	White	5-20R	•	•	•
PT2097HGBK	20	125	Black	5-20R	•	•	•
PT2097HGB	20	125	Brown	5-20R	•	•	•
PT2097HGGRY	20	125	Gray	5-20R	•	•	•
PT2097HGRED	20	125	Red	5-20R	•	•	•
PT2097HGLA	20	125	Light Almond	5-20R	•	•	•

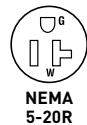
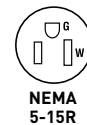

CATALOG NUMBER	WIRE TYPE	WIRE LENGTH
PLUGTAIL CONNECTORS – RIGHT ANGLE		
PTRA6STR	Stranded	6"
PTRA6SOL	Solid	6"

For additional PlugTail Connectors, see Page E-18.

All PlugTail Connectors are available in any wire length up to 25 inches, consult factory to order.

All devices listed on this page conform to NEMA WD-1 and WD-6.

HOSPITAL GRADE DEVICES

PlugTail® Tamper-Resistant GFCI Receptacles 2 Pole, 3 Wire Grounding 15 & 20A, 125VAC

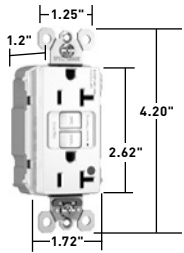

PT2097HGTRW

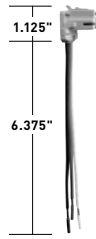

PTRA6STR

Features

- Protects children: patented shutter system helps prevent improper insertion of foreign objects.
- Meets National Electrical Code® Tamper-Resistant requirements.
- Faster, more reliable installation.
- No exposed terminals create a finger safe application before, during, and after installation.
- Built-in connector features large brass terminal blades to ensure consistent, reliable electrical connections to PlugTail Connector.
- GFCI works with the existing 3-wire PlugTail Connectors creating a non-feed-thru application for facility owners. At rough-in just install the same right angle connector for GFCI and receptacle openings.
- SafeLock® Protection: if critical components are damaged and ground fault protection is lost, power to receptacle is disconnected.
- FSUL Listed (Federal Specification WC596).
- Exceeds UL943 voltage surge requirements; survives 100x the required UL 3kA/6kV voltage surge test cycles.
- Trip indicator light (red LED).
- Mounting screws are shipped captive in the device and wall plate for easier installation.
- High-impact-resistant thermoplastic construction.
- Zinc-impact steel mounting strap.
- Buttons colors match the device face.
- Dual-direction test and reset buttons.
- Class A rated GFCI.
- Supplied with matching TP26 nylon wall plate.
- Tri-drive screws.

CATALOG NUMBER	RATING		COLOR	NEMA CONFIG. NO.	3rd PARTY COMPLIANCE		
	A.	VAC			UL943 C22.2 No. 144	UL498 C22.2 No. 42	FSUL WC596
TAMPER-RESISTANT 15 AMP DUPLEX GFCI							
PT1597HGTRI	15	125	Ivory	5-15R	•	•	•
PT1597HGTRW	15	125	White	5-15R	•	•	•
PT1597HGRBK	15	125	Black	5-15R	•	•	•
PT1597HGTRRED	15	125	Red	5-15R	•	•	•
PT1597HGTRLA	15	125	Light Almond	5-15R	•	•	•
TAMPER-RESISTANT 20 AMP DUPLEX GFCI							
PT2097HGTRI	20	125	Ivory	5-20R	•	•	•
PT2097HGTRW	20	125	White	5-20R	•	•	•
PT2097HGRBK	20	125	Black	5-20R	•	•	•
PT2097HGTRGRY	20	125	Gray	5-20R	•	•	•
PT2097HGTRRED	20	125	Red	5-20R	•	•	•
PT2097HGTRLA	20	125	Light Almond	5-20R	•	•	•

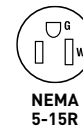

For PlugTail Connector catalog numbers, see Page E-18.

HOSPITAL GRADE DEVICES

PlugTail® Tamper-Resistant Night Light/GFCI Receptacles

2 Pole, 3 Wire Grounding 15 & 20A, 125VA

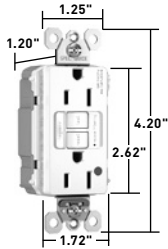

PT1597HGNTLTRI

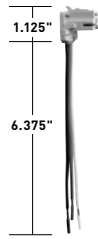

PTR6STR

Features

- Protects children: patented shutter system helps prevent improper insertion of foreign objects.
- Meets National Electrical Code® Tamper-Resistant requirements.
- Sealed nightlight with high impact-resistant Lexan® lens prevents tampering.
- Night Light uses cooler LED illumination.
- Energy-efficient LED has average 20-year life expectancy, eliminating bulb replacement.
- Rated at 186 milliwatts @ 125V.
- Photocell turns nightlight ON in dark, OFF in daylight.
- Faster, more reliable installation.
- No exposed terminals create a finger safe application before, during, and after installation.
- Built-in connector features large brass terminal blades to ensure consistent, reliable electrical connections to PlugTail Connector.
- GFCI works with the existing 3-wire PlugTail Connectors creating a non-feed-thru application for facility owners. At rough-in just install the same right angle connector for GFCI and receptacle openings.
- SafeLock® Protection: if critical components are damaged and ground fault protection is lost, power to receptacle is disconnected.
- Exceeds UL943 voltage surge requirements; survives 100x the required UL 3kA/6kV voltage surge test cycles.
- FSUL Listed (Federal Specification WC596).
- Trip indicator light (red LED).
- Mounting screws are shipped captive in the device and wall plate for easier installation.
- High-impact-resistant thermoplastic construction.
- Zinc-impact steel mounting strap.
- Buttons colors match the device face.
- Dual-direction test and reset buttons.
- Class A rated GFCI.
- Supplied with matching TP26 nylon wall plate.
- Tri-drive screws.

Specifications

- Supply Voltage: 125VAC, 60 Hz
- Supply Voltage Range: 102-132 VAC
- Trio Threshold: 5± 1mA
- Trip Time: 0.025 sec., nominal per UL Standard
- 20 Amp feed-thru capacity

CATALOG NUMBER	RATING		COLOR	NEMA CONFIG. NO.	3rd PARTY COMPLIANCE		
	A.	VAC			UL943 C22.2 No. 144	UL498 C22.2 No. 42	FSUL WC596
TAMPER-RESISTANT 15 AMP COMBINATION NIGHT LIGHT/GFCI							
PT1597HGNTLTRI	15	125	Ivory	5-15R	•	•	•
PT1597HGNTLTRRED	15	125	Red	5-15R	•	•	•
TAMPER-RESISTANT 20 AMP COMBINATION NIGHT LIGHT/GFCI							
PT2097HGNTLTRI	20	125	Ivory	5-20R	•	•	•
PT2097HGNTLTRW	20	125	White	5-20R	•	•	•
PT2097HGNTLTRLA	20	125	Light Almond	5-20R	•	•	•
PT2097HGNTLTRGRY	20	125	Gray	5-20R	•	•	•

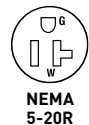
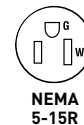

For PlugTail Connector catalog numbers, see Page E-18.

HOSPITAL GRADE DEVICES

NAFTA-Compliant GFCI Receptacles 2 Pole, 3 Wire Grounding 15 & 20A, 125VAC

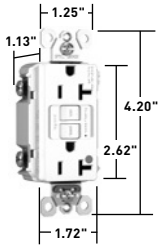

2097HGTRNAW

CATALOG NUMBER	RATING		COLOR	NEMA CONFIG. NO.	3rd PARTY COMPLIANCE		
	A.	VAC			UL943 C22.2 No. 144	UL498 C22.2 No. 42	FSUL WC596
NAFTA-COMPLIANT TAMPER-RESISTANT 20 AMP DUPLEX GFCI							
2097HGTRNAI	20	125	Ivory	5-20R	•	•	•
2097HGTRNAW	20	125	White	5-20R	•	•	•
2097HGTRNARED	20	125	Red	5-20R	•	•	•
2097HGTRNALA	20	125	Light Almond	5-20R	•	•	•
NAFTA-COMPLIANT 20 AMP DUPLEX GFCI							
2097HGNAI	20	125	Ivory	5-20R	•	•	•
2097HGNAW	20	125	White	5-20R	•	•	•
2097HGNAGRY	20	125	Gray	5-20R	•	•	•
2097HGNARED	20	125	Red	5-20R	•	•	•
2097HGNALA	20	125	Light Almond	5-20R	•	•	•

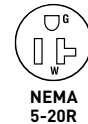
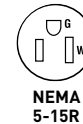

NAFTA-Compliant GFCI Receptacles are ideal for use on projects subject to the provisions of the Buy American Act.

HOSPITAL GRADE DEVICES

NAFTA-Compliant PlugTail® GFCI Receptacles 2 Pole, 3 Wire Grounding 15 & 20A, 125VAC

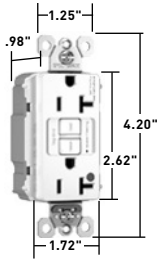

PT2097HGNAW

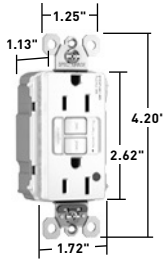

PT2097HGNTLTRNAW

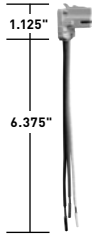

PTRA6STR

Features

- Faster, more reliable installation.
- No exposed terminals create a finger safe application before, during, and after installation.
- Built-in connector features large brass terminal blades to ensure consistent, reliable electrical connections to PlugTail Connector.
- GFCI works with the existing 3-wire PlugTail Connectors creating a non-feed-thru application for facility owners. At rough-in just install the same right angle connector for GFCI and receptacle openings.
- SafeLock® Protection: if critical components are damaged and ground fault protection is lost, power to receptacle is disconnected.
- FSUL Listed (Federal Specification WC596).
- Exceeds UL943 voltage surge requirements; survives 100x the required UL 3kA/6kV voltage surge test cycles.
- Trip indicator light (red LED).
- Mounting screws are shipped captive in the device and wall plate for easier installation.
- High-impact-resistant thermoplastic construction.
- Zinc-impact steel mounting strap.
- Buttons colors match the device face.
- Dual-direction test and reset buttons.
- Class A rated GFCI.
- Supplied with matching TP26 nylon wall plate.
- Tri-drive screws.

Specifications

- Supply Voltage: 125VAC, 60 Hz
- Supply Voltage Range: 102-132 VAC
- Trio Threshold: 5± 1mA
- Trip Time: 0.025 sec., nominal per UL Standard
- 20 Amp feed-thru capacity

CATALOG NUMBER	RATING		COLOR	NEMA CONFIG. NO.	3rd PARTY COMPLIANCE		
	A.	VAC			UL943 C22.2 No. 144	UL498 C22.2 No. 42	FSUL WC596
NAFTA-COMPLIANT 20 AMP DUPLEX GFCI							
PT2097HGNAI	20	125	Ivory	5-20R	•	•	•
PT2097HGNAW	20	125	White	5-20R	•	•	•
PT2097HGNAGRY	20	125	Gray	5-20R	•	•	•
PT2097HGNARED	20	125	Red	5-20R	•	•	•
NAFTA-COMPLIANT TAMPER-RESISTANT 20 AMP DUPLEX GFCI							
PT2097HGTRNAI	20	125	Ivory	5-20R	•	•	•
PT2097HGTRNAW	20	125	White	5-20R	•	•	•
PT2097HGTRNAGRY	20	125	Gray	5-20R	•	•	•
NAFTA-COMPLIANT TAMPER-RESISTANT 20 AMP COMBINATION NIGHT LIGHT/GFCI							
PT2097HGNTLTRNAI	20	125	Ivory	5-20R	•	•	•

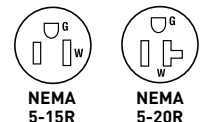

NAFTA-Compliant GFCI Receptacles are ideal for use on projects subject to the provisions of the Buy American Act.

CATALOG NUMBER	WIRE TYPE	WIRE LENGTH
PLUGTAIL CONNECTORS – RIGHT ANGLE		
PTRA6SOL	Solid	6"
PTRA6STR	Stranded	6"

For additional PlugTail Connectors, see Page E-18.

All PlugTail Connectors are available in any wire length up to 25 inches, consult factory to order.

HOSPITAL GRADE DEVICES

Surge Protective Receptacles 2 Pole, 3 Wire Grounding 15 & 20A, 125VAC

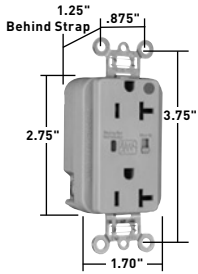

8300GRYSP

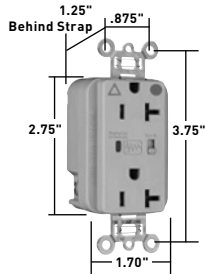

IG8300GRYSP

Specifications

- UL1449 (3rd Edition). (1.2 x 50µs 6000V, 8 x 20µs 3000A).
- 24,000 amps current handling capability in each of 3 modes: line to neutral, line to ground, neutral to ground.
- LED indication: Steady green = protected; Flashing red = not protected OFF = no power to unit
- Response time less than 1 nanosecond for unmounted MOV.
- Overcurrent protection in all 3 modes.
- Printed circuit board conformally coated to protect against condensing humidity and airborne particulates.
- Thermal protection in all 3 modes.
- Leakage current: 0.5 mA at 25°C/120VAC.
- Common mode noise attenuation: 500 KHz to 30 MHz; up to 20 dB (50 ohm source impedance)
- Varistor voltage: 130V RMS.
- Back and side wire capability including ground terminal.
- Operating temperature: -40°C to 85°C (-40°F to 185°F)

8200/8300, IG8200/8300, TR8200/8300, TRIG8200/8300

- 340 joules of energy absorption in each of the 3 modes. Energy (measured for an 8x20µs duration) = 340J.
- Nominal let-through (suppressed) voltage in all 3 modes, 500V.
- Audible alarm able to be turned on/off.
- 3 17mm dual pack MOVs to suppress transients in all modes – equally.
- Isolated Ground version complies with NEC 410-56 (C) and 250-146.

Audible Alarm with LED Indicator

CATALOG NUMBER	RATING		COLOR	NEMA CONFIG. NO.	3rd PARTY COMPLIANCE			
	A.	VAC			UL1449	UL498	FSUL WC596	cUL/CSA
DUPLEX RECEPTACLES BACK & SIDE WIRE								
8200ISP	15	125	Ivory	5-15R	•	•	•	•
8200WSP	15	125	White	5-15R	•	•	•	•
8200SP	15	125	Brown	5-15R	•	•	•	•
8200REDSP	15	125	Red	5-15R	•	•	•	•
8200BLSP	15	125	Blue	5-15R	•	•	•	•
8300ISP	20	125	Ivory	5-20R	•	•	•	•
8300WSP	20	125	White	5-20R	•	•	•	•
8300SP	20	125	Brown	5-20R	•	•	•	•
8300GRYSP	20	125	Gray	5-20R	•	•	•	•
8300REDSP	20	125	Red	5-20R	•	•	•	•
8300LASP	20	125	Light Almond	5-20R	•	•	•	•
8300BLSP	20	125	Blue	5-20R	•	•	•	•
ISOLATED GROUND DUPLEX RECEPTACLES BACK & SIDE WIRE								
IG8200ISP	15	125	Ivory	5-15R	•	•	•	•
IG8200WSP	15	125	White	5-15R	•	•	•	•
IG8200BLSP	15	125	Blue	5-15R	•	•	•	•
IG8200OSP	15	125	Orange	5-15R	•	•	•	•
IG8300ISP	20	125	Ivory	5-20R	•	•	•	•
IG8300WSP	20	125	White	5-20R	•	•	•	•
IG8300GRYSP	20	125	Gray	5-20R	•	•	•	•
IG8300BLSP	20	125	Blue	5-20R	•	•	•	•
IG8300OSP	20	125	Orange	5-20R	•	•	•	•

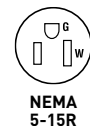

Conforms to the latest revision ANSI/IEEE C62.41 (formerly IEEE587), ANSI/IEEE C62.45.

HOSPITAL GRADE DEVICES

PlugTail® Surge Protective Receptacles 2 Pole, 3 Wire Grounding, 15 & 20A, 125VAC

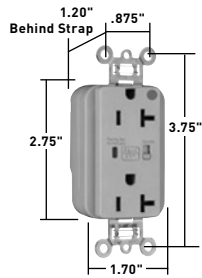

PT8300GRYSP

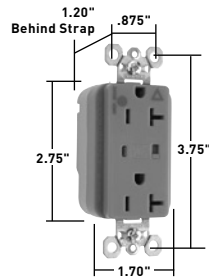

PTIG83000SP

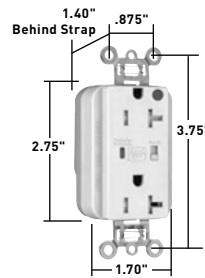

PTTR8300ISP

Audible Alarm with LED Indicator

CATALOG NUMBER	RATING		COLOR	NEMA CONFIG. NO.	3rd PARTY COMPLIANCE			
	A.	VAC			UL1449	UL498	FSUL WC596	cUL/CSA
EXTRA HEAVY-DUTY DUPLEX RECEPTACLES								
PT8200ISP	15	125	5-15R	Ivory	•	•	•	•
PT8200WSP	15	125	5-15R	White	•	•	•	•
PT8200SP	15	125	5-15R	Brown	•	•	•	•
PT8200BLSP	15	125	5-15R	Blue	•	•	•	•
PT8300ISP	20	125	5-20R	Ivory	•	•	•	•
PT8300WSP	20	125	5-20R	White	•	•	•	•
PT8300SP	20	125	5-20R	Brown	•	•	•	•
PT8300GRYSP	20	125	5-20R	Gray	•	•	•	•
PT8300REDSP	20	125	5-20R	Red	•	•	•	•
PT8300BLSP	20	125	5-20R	Blue	•	•	•	•
ISOLATED GROUND DUPLEX RECEPTACLES								
PTIG8200REDSP	15	125	5-15R	Red	•	•	•	•
PTIG8200LASP	15	125	5-15R	Light Almond	•	•	•	•
PTIG82000SP	15	125	5-15R	Orange	•	•	•	•
PTIG8300REDSP	20	125	5-20R	Red	•	•	•	•
PTIG8300BLSP	20	125	5-20R	Blue	•	•	•	•
PTIG83000SP	20	125	5-20R	Orange	•	•	•	•
TAMPER-RESISTANT DUPLEX RECEPTACLES								
PTTR8200WSP	15	125	5-15R	White	•	•	•	•
PTTR8200REDSP	15	125	5-15R	Red	•	•	•	•
PTTR8200BLSP	15	125	5-15R	Blue	•	•	•	•
PTTR8300ISP	20	125	5-20R	Ivory	•	•	•	•
PTTR8300WSP	20	125	5-20R	White	•	•	•	•
PTTR8300GRYSP	20	125	5-20R	Gray	•	•	•	•
PTTR8300REDSP	20	125	5-20R	Red	•	•	•	•
PTTR8300BLSP	20	125	5-20R	Blue	•	•	•	•

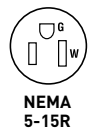
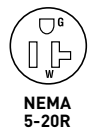

For PlugTail Connectors, see Page E-18.

Conforms to the latest revision ANSI/IEEE C62.41 (formerly IEEE587), ANSI/IEEE C62.45.

All devices listed on this page conform to NEMA WD-1 and WD-6.

HOSPITAL GRADE DEVICES

Tamper-Resistant Surge Protective Receptacles 2 Pole, 3 Wire Grounding, 15 & 20A, 125VAC

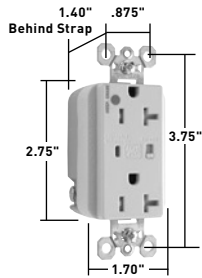

TR8300ISP

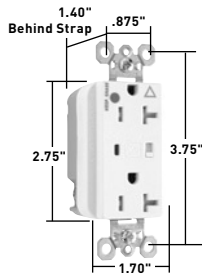

TRIG8300WSP

Audible Alarm with LED Indicator

CATALOG NUMBER	RATING		COLOR	NEMA CONFIG. NO.	3rd PARTY COMPLIANCE			
	A.	VAC			UL1449	UL498	FSUL WC596	cUL/CSA
EXTRA HEAVY-DUTY DUPLEX RECEPTACLES BACK & SIDE WIRE								
TR8200WSP	15	125	5-15R	White	•	•	•	•
TR8200SP	15	125	5-15R	Brown	•	•	•	•
TR8200REDSP	15	125	5-15R	Red	•	•	•	•
TR8200LASP	15	125	5-15R	Light Almond	•	•	•	•
TR8300ISP	20	125	5-20R	Ivory	•	•	•	•
TR8300WSP	20	125	5-20R	White	•	•	•	•
TR8300REDSP	20	125	5-20R	Red	•	•	•	•
TR8300BLSP	20	125	5-20R	Blue	•	•	•	•
ISOLATED GROUND DUPLEX RECEPTACLES BACK & SIDE WIRE								
TRIG8200WSP	15	125	5-15R	White	•	•	•	•
TRIG8200REDSP	15	125	5-15R	Red	•	•	•	•
TRIG8200BLSP	15	125	5-15R	Blue	•	•	•	•
TRIG8300ISP	20	125	5-20R	Ivory	•	•	•	•
TRIG8300WSP	20	125	5-20R	White	•	•	•	•
TRIG8300REDSP	20	125	5-20R	Red	•	•	•	•
TRIG8300BLSP	20	125	5-20R	Blue	•	•	•	•
TRIG8300OSP	20	125	5-20R	Orange	•	•	•	•

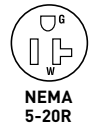
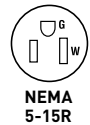

Conforms to the latest revision ANSI/IEEE C62.41 (formerly IEEE587), ANSI/IEEE C62.45.

HOSPITAL GRADE DEVICES

IP20
Suitability

Straight Blade Plugs & Connectors 2 Pole, 3 Wire Grounding 15 & 20A, 125 & 250V



Features

- Unit arrives completely ready-to-wire, cuts installation time significantly.
- Nylon housing provides impact and chemical resistance.
- Rugged two-piece cord provides more uniform cord retention.
- Internal dust shield keeps terminals free of contaminants.
- Tri-drive assembly screws are standard on Hospital Grade plugs and connectors (angle plugs not included).
- All 3-wire terminals located on the same plane, allows for quick wire termination from any angle.
- Heavy-duty brass alloy blades and contacts resist heat rise, provide excellent conductivity.
- Cord-grip screws recessed to protect installer against screwdriver head slippage.

CATALOG NUMBER	RATING		DESCRIPTION	CORD DIAMETER	NEMA CONFIG. NO.	3rd PARTY COMPLIANCE		
	A.	V.				UL498	FSUL WC596	C22.2 NO.42
EXTRA-HARD USE (EHU)								
PS5266XH	15	125	Plug, Black & Clear	.230"-.720"	5-15P	•	•	•
PS5266HG	15	125	Angle Plug, Black & Clear	.320"-.655"	5-15P	•	•	•
PS5269XH	15	125	Connector, Black & Clear	.230"-.720"	5-15R	•	•	•
PS5366XH	20	125	Plug, Black & Clear	.230"-.720"	5-20P	•	•	•
PS5366HG	20	125	Angle Plug, Black & Clear	.320"-.655"	5-20P	•	•	•
PS5369XH	20	125	Connector, Black & Clear	.230"-.720"	5-20R	•	•	•
PS5666XH	15	250	Plug, Black & Clear	.230"-.720"	6-15P	•	•	•
PS5666HG	15	250	Angle Plug, Black & Clear	.320"-.655"	6-15P	•	•	•
PS5669XH	15	250	Connector, Black & Clear	.230"-.720"	6-15R	•	•	•
PS5466XH	20	250	Plug, Black & Clear	.230"-.720"	6-20P	•	•	•
PS5466HG	20	250	Angle Plug, Black & Clear	.320"-.655"	6-20P	•	•	•
PS5469XH	20	250	Connector, Black & Clear	.230"-.720"	6-20R	•	•	•
MAXGRIP® M³								
PS8115	15	125	Plug, White	.230"-.720"	5-15P	•	•	•
PS8119	15	125	Connector, White	.230"-.720"	5-15R	•	•	•
PS8115BK	15	125	Plug, Black	.230"-.720"	5-15P	•	•	•
PS8119BK	15	125	Connector, Black	.230"-.720"	5-15R	•	•	•

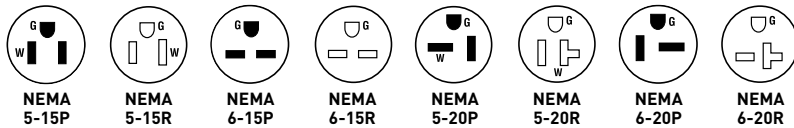

CATALOG NUMBER	DESCRIPTION
ACCESSORIES	
EHU15AN	15 & 20A EHU Straight Blade, Right Angle Adapter
FC22GL	EHU-Strain Relief Grip*
FC30GL	EHU-Strain Relief Grip*
FC40GL	EHU-Strain Relief Grip*
FC52GL	EHU-Strain Relief Grip*

*For further information consult the Flexcor® Section K.

All devices listed on this page conform to NEMA WD-1 and WD-6.

HOSPITAL GRADE DEVICES

Quad Receptacles 20A, 125V

Application

Pass & Seymour quad receptacles are designed for dense, multiple-outlet applications such as personal computers and peripherals, office equipment, and home entertainment centers. The bidirectional outlet configuration allows use of up to four

oversized plugs, in close proximity. The clean, contemporary design of the quad receptacle allows for surface mounting with minimal protrusion from the wall. No wall plate is required.

Features

- Rugged nylon face and body withstands impacts and hard use.
- Built-in wire stripping gauge.
- Outward-facing ground terminals make handling up to four straight or angled plugs easy and convenient.
- Heavy-duty, phosphor bronze contacts.
- Shielding walls guard against live-circuit-to-ground shorts.
- Split circuit break-off tabs.
- UL and CSA listed.

CATALOG NUMBER	RATING		COLOR	NEMA CONFIG. NO.	3rd PARTY COMPLIANCE		
	A.	V.			UL498	UL1449	CSA
ISOLATED GROUND SURGE PROTECTIVE QUADS							
IG420HISP	20	125	Ivory	5-20R	•	•	
IG420HBLSP	20	125	Blue	5-20R	•	•	
QUADS							
420HI	20	125	Ivory	5-20R	•		•
420HW	20	125	White	5-20R	•		•
420H	20	125	Brown	5-20R	•		•
420HGRY	20	125	Gray	5-20R	•		•
420HRED	20	125	Red	5-20R	•		•

2 Pole, 3 Wire

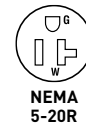

Hard Use Spec Grade & Hard Use Surge Protective Spec Grade Quads

- Isolated ground complied with NEC® 410-56(c) and 250-74 exception 4
- Conforms to NEMA WD-1, WD-6.

Electrical

Frequency 60Hz
Voltage 125V

Mechanical

Terminal Identification Brass = Hot, Nickel = Neutral, Green = Ground
Terminal Accommodation #14 -12 AWG copper and copper-clad
Product Identification Ratings are permanent part of device
Weight 10.75 oz.

Environmental

Flammability UL94 V2
Operating Temperature -40°C to 65°C (-40°F to 150°F) continuous without impact

Materials

Face Nylon
Body Nylon
Line Terminals .035" T-type Triple-Wipe Phosphor Bronze
Terminal Screws Brass #8-32
Hex Head Grounding Screw Steel (Green)
Mounting Screws Zinc-plated steel

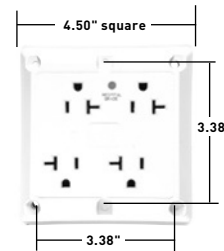

Quad Receptacle

Additional Specifications for Hard Use Surge Protective Spec Grade Quads

- ANSI /IEEE C62.41 (formerly IEEE 587), ANSI/IEEE C62.45
- Installation Categories "A" (ring wave) and "B" (unidirectional impulse)

Electrical

MOV Rating 18mm
UL1449 Suppressed Voltage Rating 500V (L-N, L-G, N-G)
Noise Attenuation -35db Noise Filtering at 5kHz-50MHz
Thermal Protection Fused
Green LED Indicator ON when protection is active, OFF when protection is inactive

SURGE PROTECTIVE & ISOLATED GROUND DEVICES



Surge protective device offering with increased transient protection, reliability and protection notification — for industrial, commercial, and residential applications in the electronics age.

Surge Protective Devices Product Description	F-2
Product Specifications	F-2
PlugTail® Surge Protective Receptacles	F-3
PlugTail® Hospital Grade Surge Protective Receptacles	F-4
Hospital Grade Surge Protective Receptacles	F-5
Surge Protective Receptacles	F-6
Tamper-Resistant Surge Protective Receptacles	F-7
Isolated Ground Receptacles	F-8, F-11, F-13
Tamper-Resistant Hospital Grade Surge Protective Receptacles	F-9
Isolated Ground Product Description	F-10
PlugTail® Isolated Ground Receptacles	F-12
Tamper-Resistant Isolated Ground Receptacles	F-14
Turnlok® Isolated Ground Receptacles	F-15
Power & Surge Protection Strips & Specifications	F-16

Featured Products



**PLUGTAIL®
SURGE PROTECTIVE
RECEPTACLE**

F-3



**PLUGTAIL® HOSPITAL
GRADE SURGE
PROTECTIVE
RECEPTACLE**

F-4

SURGE PROTECTIVE & ISOLATED GROUND DEVICES

Product Description & Specifications

Surge Protective Devices

Office buildings, schools and campuses, hospitals and medical facilities, and your own home; the use of microprocessor-based equipment has become prevalent in all day-to-day environments. Commercial and industrial facilities have computer, IT, and telephone systems; and control and automation equipment. Retail locations have sophisticated cash registers, electronic scanning, and security systems. At home, we have desktop and laptop computers, smart telephones, high-definition TVs, audio and home theater equipment, gaming systems, and control systems (thermostats, garage door openers, etc.). In today's world we are dependent on (and take for granted) the performance of all this sophisticated yet sensitive equipment.

All microprocessor-based equipment is extremely sensitive to momentary spikes and surges that occur daily over AC circuits. Sources for these transient spikes and surges range from lightning and utility switching to inductive

load switching such as air conditioners, power tools, vacuum cleaners, and copy machines. Externally or internally induced, high energy spikes and surges are capable of causing catastrophic instantaneous damage or cumulative transients that continue to erode the effectiveness of the equipment, hindering performance until it prematurely fails.

The best line of defense for any location is a coordination of protection at the service entrance, branch service locations, and at the point of use. Pass & Seymour Surge Protection products offer a full line of receptacles and portable/plug-in units with multiple outlets, phone, and data protection. This offering allows you to cost effectively provide the right protection for your specific application.

Product Specifications

Specifications – 5262/5362, IG5262/5362, 8200/8300, IG8200/8300, TR5262/5362, TRIG5262/5362, TR8200/8300, TRIG8200/8300

- UL1449 (3rd Edition). [1.2 x 50µs 6000V, 8 x 20µs 3000A].
- 340 joules of energy absorption in each of the 3 modes. Energy (measured for an 8x20µs duration) = 340J.
- 24,000 amps current handling capability in each of 3 modes: line to neutral, line to ground, neutral to ground.
- Nominal let-through (suppressed) voltage in all 3 modes, 500V.
- Audible alarm able to be turned on/off.
- LED indication:
Steady green = protected
Flashing red = not protected
OFF = no power to unit
- Response time less than 1 nanosecond for unmounted MOV.
- Overcurrent protection in all 3 modes.
- Printed circuit board conformally coated to protect against condensing humidity and airborne particulates.
- Thermal protection in all 3 modes.
- Leakage current: 0.5 mA at 25°C/120VAC.
- 3 17mm dual pack MOVs to suppress transients in all modes – equally.
- Common mode noise attenuation: 500 KHz to 30 MHz; up to 20 dB (50 ohm source impedance)
- Varistor voltage: 130V RMS.
- Back and side wire capability including ground terminal.
- Operating temperature: -40°C to 85°C (-40°F to 185°F)
- Isolated Ground version complies with NEC 410-56 (C) and 250-146.
- Conforms to the latest revision ANSI/IEEE C62.41 (formerly IEEE 587), ANSI/IEEE C62.45.

Specifications – All PlugTail® Surge Protective Receptacles

- UL1449 (3rd Edition). [1.2 x 50µs 6000V, 8 x 20µs 3000A].
- 340 joules of energy absorption in line-to-neutral and line-to-ground modes. 680 joules of energy absorption in neutral-to-ground mode. Energy (measured for an 8x20µs duration) = 340J (680J for N-G mode).
- 24,000 amps current handling capability in each of 3 modes; line to neutral, line to ground, neutral to ground.
- Nominal let-through (suppressed) voltage: Line-to-neutral and line-to-ground modes = 500V; neutral-to-ground mode = 1000V.
- LED indication:
Steady green = protected
Flashing red = not protected
OFF = no power to unit
- Response time less than 1 nanosecond for unmounted MOV.
- Overcurrent protection in all 3 modes.
- Printed circuit board conformally coated to protect against condensing humidity and airborne particulates.
- Thermal protection in all 3 modes.
- Leakage current: 0.5 mA at 25°C/120VAC.
- 2 17mm dual pack MOVs to suppress transients in all modes – equally.
- Common mode noise attenuation: 500 KHz to 30 MHz; up to 20 dB (50 ohm source impedance)
- Varistor voltage: 130V RMS.
- PlugTail versions – factory-terminated devices and connectors.
- Operating temperature: -40°C to 85°C (-40°F to 185°F)
- Conforms to the latest revision ANSI/IEEE C62.41 (formerly IEEE 587), ANSI/IEEE C62.45.

SURGE PROTECTIVE & ISOLATED GROUND DEVICES

PlugTail® Surge Protective Receptacles 2 Pole, 3 Wire Grounding, 15 & 20A, 125VAC

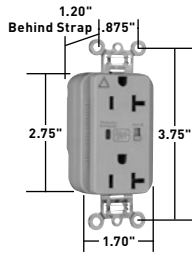

PTIG5362GRYSP

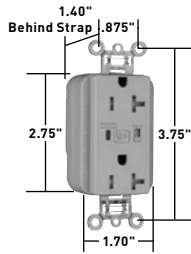

PTRR5362GRYSP

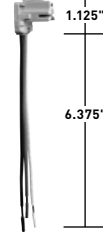

PTRA6STR

Audible Alarm with LED Indicator

CATALOG NUMBER	RATING		NEMA CONFIG. NO.	COLOR	3rd PARTY COMPLIANCE			
	A.	VAC			UL1449	UL498	FSUL WC596	cUL/CSA
EXTRA HEAVY-DUTY DUPLEX RECEPTACLES								
PT5262ISP	15	125	5-15R	Ivory	•	•	•	•
PT5262WSP	15	125	5-15R	White	•	•	•	•
PT5262GRYSP	15	125	5-15R	Gray	•	•	•	•
PT5262BKSP	15	125	5-15R	Black	•	•	•	•
PT5262BLSP	15	125	5-15R	Blue	•	•	•	•
PT5362ISP	20	125	5-20R	Ivory	•	•	•	•
PT5362WSP	20	125	5-20R	White	•	•	•	•
PT5362SP	20	125	5-20R	Brown	•	•	•	•
PT5362GRYSP	20	125	5-20R	Gray	•	•	•	•
PT5362BKSP	20	125	5-20R	Black	•	•	•	•
PT5362LASP	20	125	5-20R	Light Almond	•	•	•	•
PT5362BLSP	20	125	5-20R	Blue	•	•	•	•
ISOLATED GROUND DUPLEX RECEPTACLES								
PTIG5262WSP	15	125	5-15R	White	•	•	•	•
PTIG5262OSP	15	125	5-15R	Orange	•	•	•	•
PTIG5362ISP	20	125	5-20R	Ivory	•	•	•	•
PTIG5362WSP	20	125	5-20R	White	•	•	•	•
PTIG5362GRYSP	20	125	5-20R	Gray	•	•	•	•
PTIG5362BKSP	20	125	5-20R	Black	•	•	•	•
PTIG5362LASP	20	125	5-20R	Light Almond	•	•	•	•
PTIG5362OSP	20	125	5-20R	Orange	•	•	•	•
TAMPER-RESISTANT DUPLEX RECEPTACLES								
PTRR5262WSP	15	125	5-15R	White	•	•	•	•
PTRR5262SP	15	125	5-15R	Brown	•	•	•	•
PTRR5362ISP	20	125	5-20R	Ivory	•	•	•	•
PTRR5362WSP	20	125	5-20R	White	•	•	•	•
PTRR5362GRYSP	20	125	5-20R	Gray	•	•	•	•
PTRR5362LASP	20	125	5-20R	Light Almond	•	•	•	•
PTRR5362BLSP	20	125	5-20R	Blue	•	•	•	•

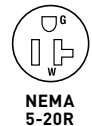
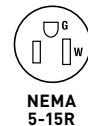

CATALOG NUMBER	WIRE TYPE	WIRE LENGTH
PLUGTAIL CONNECTORS – RIGHT ANGLE		
PTRA6SOL	Solid	6"
PTRA6STR	Stranded	6"
PTRA6SOLB25	Solid	25"
PTRA6STRB25	Stranded	25"
NAFTA-COMPLIANT PLUGTAIL CONNECTORS – RIGHT ANGLE		
PTRA6SOLNA	Solid	6"
PTRA6STRNA	Stranded	6"
PLUGTAIL CONNECTORS – RIGHT ANGLE WITH WAGO CONNECTORS		
PTRA6SOLBP	Solid	6"
PTRA6STRBP	Stranded	6"
PLUGTAIL CONNECTORS – RIGHT ANGLE WITH GROUND SCREW		
PTRA6SOLG	Solid	6"
PTRA6STRG	Stranded	6"

All devices listed on this page conform to NEMA WD-1 and WD-6. Conforms to the latest revision ANSI/IEEE C62.41 (formerly IEEE587), ANSI/IEEE C62.45.

SURGE PROTECTIVE & ISOLATED GROUND DEVICES

PlugTail® Hospital Grade Surge Protective Receptacles

2 Pole, 3 Wire Grounding, 15 & 20A, 125VAC

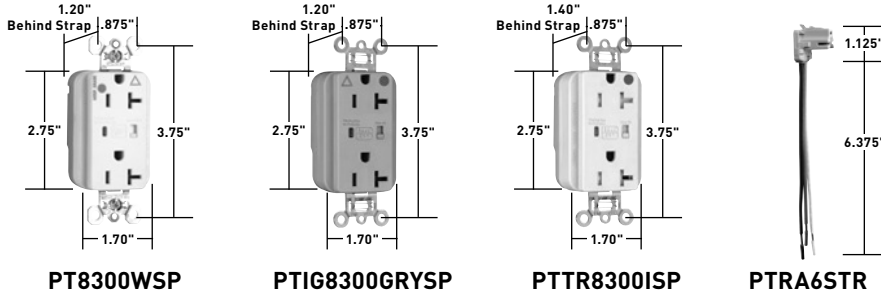

Audible Alarm with LED Indicator

CATALOG NUMBER	RATING		NEMA CONFIG. NO.	COLOR	3rd PARTY COMPLIANCE			
	A.	VAC			UL1449	UL498	FSUL WC596	cUL/CSA
EXTRA HEAVY-DUTY DUPLEX RECEPTACLES								
PT8200ISP	15	125	5-15R	Ivory	•	•	•	•
PT8200WSP	15	125	5-15R	White	•	•	•	•
PT8200SP	15	125	5-15R	Brown	•	•	•	•
PT8200BLSP	15	125	5-15R	Blue	•	•	•	•
PT8300ISP	20	125	5-20R	Ivory	•	•	•	•
PT8300WSP	20	125	5-20R	White	•	•	•	•
PT8300SP	20	125	5-20R	Brown	•	•	•	•
PT8300GRYSP	20	125	5-20R	Gray	•	•	•	•
PT8300REDSP	20	125	5-20R	Red	•	•	•	•
ISOLATED GROUND DUPLEX RECEPTACLES								
PTIG8200REDSP	15	125	5-15R	Red	•	•	•	•
PTIG8200LASP	15	125	5-15R	Light Almond	•	•	•	•
PTIG8200OSP	15	125	5-15R	Orange	•	•	•	•
PTIG8300SP	20	125	5-20R	Brown	•	•	•	•
PTIG8300REDSP	20	125	5-20R	Red	•	•	•	•
PTIG8300BLSP	20	125	5-20R	Blue	•	•	•	•
PTIG8300OSP	20	125	5-20R	Orange	•	•	•	•
TAMPER-RESISTANT DUPLEX RECEPTACLES								
PTTR8200WSP	15	125	5-15R	White	•	•	•	•
PTTR8200REDSP	15	125	5-15R	Red	•	•	•	•
PTTR8200BLSP	15	125	5-15R	Blue	•	•	•	•
PTTR8300ISP	20	125	5-20R	Ivory	•	•	•	•
PTTR8300WSP	20	125	5-20R	White	•	•	•	•
PTTR8300GRYSP	20	125	5-20R	Gray	•	•	•	•
PTTR8300REDSP	20	125	5-20R	Red	•	•	•	•
PTTR8300BLSP	20	125	5-20R	Blue	•	•	•	•

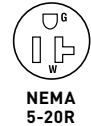
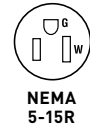

SURGE PROTECTIVE & ISOLATED GROUND DEVICES

CATALOG NUMBER	WIRE TYPE	WIRE LENGTH
PLUGTAIL CONNECTORS – RIGHT ANGLE		
PTRA6SOL	Solid	6"
PTRA6STR	Stranded	6"
PTRA6SOLB25	Solid	25"
PTRA6STRB25	Stranded	25"
NAFTA-COMPLIANT PLUGTAIL CONNECTORS – RIGHT ANGLE		
PTRA6SOLNA	Solid	6"
PTRA6STRNA	Stranded	6"
PLUGTAIL CONNECTORS – RIGHT ANGLE WITH WAGO CONNECTORS		
PTRA6SOLBP	Solid	6"
PTRA6STRBP	Stranded	6"
PLUGTAIL CONNECTORS – RIGHT ANGLE WITH GROUND SCREW		
PTRA6SOLG	Solid	6"
PTRA6STRG	Stranded	6"

SURGE PROTECTIVE & ISOLATED GROUND DEVICES

Hospital Grade Surge Protective Receptacles 2 Pole, 3 Wire Grounding 15 & 20A, 125VAC

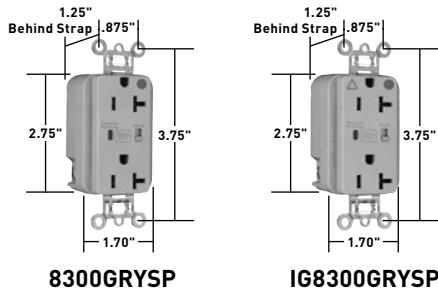

Audible Alarm with LED Indicator

CATALOG NUMBER	RATING		NEMA CONFIG. NO.	COLOR	3rd PARTY COMPLIANCE			
	A.	VAC			UL1449	UL498	FSUL WC596	cUL/CSA
DUPLEX RECEPTACLES BACK & SIDE WIRE								
8200ISP	15	125	5-15R	Ivory	•	•	•	•
8200WSP	15	125	5-15R	White	•	•	•	•
8200SP	15	125	5-15R	Brown	•	•	•	•
8200REDSP	15	125	5-15R	Red	•	•	•	•
8200BLSP	15	125	5-15R	Blue	•	•	•	•
8300ISP	20	125	5-20R	Ivory	•	•	•	•
8300WSP	20	125	5-20R	White	•	•	•	•
8300SP	20	125	5-20R	Brown	•	•	•	•
8300GRYSP	20	125	5-20R	Gray	•	•	•	•
8300REDSP	20	125	5-20R	Red	•	•	•	•
8300LASP	20	125	5-20R	Light Almond	•	•	•	•
8300BLSP	20	125	5-20R	Blue	•	•	•	•
ISOLATED GROUND DUPLEX RECEPTACLES BACK & SIDE WIRE								
IG8200ISP	15	125	5-15R	Ivory	•	•	•	•
IG8200WSP	15	125	5-15R	White	•	•	•	•
IG8200BLSP	15	125	5-15R	Blue	•	•	•	•
IG8200OSP	15	125	5-15R	Orange	•	•	•	•
IG8300ISP	20	125	5-20R	Ivory	•	•	•	•
IG8300WSP	20	125	5-20R	White	•	•	•	•
IG8300GRYSP	20	125	5-20R	Gray	•	•	•	•
IG8300BLSP	20	125	5-20R	Blue	•	•	•	•
IG8300OSP	20	125	5-20R	Orange	•	•	•	•

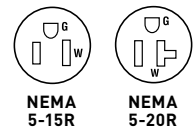

CATALOG NUMBER	DESCRIPTION	COLOR
WALL PLATES FOR SURGE PROTECTIVE DUPLEX RECEPTACLES		
SS26	Stainless Steel Decorator	
SS26IG*	Stainless Steel Decorator	
SB26	Brass Decorator	
TP26IG*	Thermoplastic Decorator	Orange
TP26BL	Thermoplastic Decorator	Blue

*For Isolated Ground

All devices listed on this page conform to NEMA WD-1 and WD-6. Conforms to the latest revision ANSI/IEEE C62.41 (formerly IEEE587), ANSI/IEEE C62.45.

SURGE PROTECTIVE & ISOLATED GROUND DEVICES

Surge Protective Receptacles 2 Pole, 3 Wire Grounding 15 & 20A, 125VAC

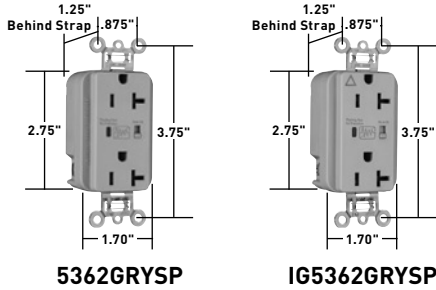

Audible Alarm with LED Indicator

CATALOG NUMBER	RATING		NEMA CONFIG. NO.	COLOR	3rd PARTY COMPLIANCE			
	A.	VAC			UL1449	UL498	FSUL WC596	cUL/CSA
EXTRA HEAVY-DUTY DUPLEX RECEPTACLES BACK & SIDE WIRE								
5262ISP	15	125	5-15R	Ivory	•	•	•	•
5262WSP	15	125	5-15R	White	•	•	•	•
5262SP	15	125	5-15R	Brown	•	•	•	•
5262BKSP	15	125	5-15R	Black	•	•	•	•
5262REDSP	15	125	5-15R	Red	•	•	•	•
5262LASP	15	125	5-15R	Light Almond	•	•	•	•
5262BLSP	15	125	5-15R	Blue	•	•	•	•
5362ISP	20	125	5-20R	Ivory	•	•	•	•
5362WSP	20	125	5-20R	White	•	•	•	•
5362SP	20	125	5-20R	Brown	•	•	•	•
5362GRYSP	20	125	5-20R	Gray	•	•	•	•
5362BKSP	20	125	5-20R	Black	•	•	•	•
5362REDSP	20	125	5-20R	Red	•	•	•	•
5362LASP	20	125	5-20R	Light Almond	•	•	•	•
5362BLSP	20	125	5-20R	Blue	•	•	•	•
ISOLATED GROUND DUPLEX RECEPTACLES BACK & SIDE WIRE								
IG5262ISP	15	125	5-15R	Ivory	•	•	•	•
IG5262WSP	15	125	5-15R	White	•	•	•	•
IG5262GRYSP	15	125	5-15R	Gray	•	•	•	•
IG5262BLSP	15	125	5-15R	Blue	•	•	•	•
IG5262OSP	15	125	5-15R	Orange	•	•	•	•
IG5362ISP	20	125	5-20R	Ivory	•	•	•	•
IG5362WSP	20	125	5-20R	White	•	•	•	•
IG5362SP	20	125	5-20R	Brown	•	•	•	•
IG5362GRYSP	20	125	5-20R	Gray	•	•	•	•
IG5362LASP	20	125	5-20R	Light Almond	•	•	•	•
IG5362BLSP	20	125	5-20R	Blue	•	•	•	•
IG5362OSP	20	125	5-20R	Orange	•	•	•	•



NEMA 5-15R



NEMA 5-20R

SURGE PROTECTIVE & ISOLATED GROUND DEVICES

Tamper-Resistant Surge Protective Receptacles 2 Pole, 3 Wire Grounding, 15 & 20A, 125VAC

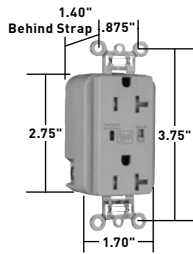

TR5362GRYSP

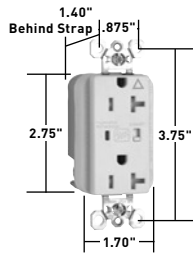

TRIG5362LASP

Audible Alarm with LED Indicator

CATALOG NUMBER	RATING		NEMA CONFIG. NO.	COLOR	3rd PARTY COMPLIANCE			
	A.	VAC			UL1449	UL498	FSUL WC596	cUL/CSA
EXTRA HEAVY-DUTY DUPLEX RECEPTACLES BACK & SIDE WIRE								
TR5262ISP	15	125	5-15R	Ivory	•	•	•	•
TR5262WSP	15	125	5-15R	White	•	•	•	•
TR5262SP	15	125	5-15R	Brown	•	•	•	•
TR5262GRYSP	15	125	5-15R	Gray	•	•	•	•
TR5262LASP	15	125	5-15R	Light Almond	•	•	•	•
TR5262BLSP	15	125	5-15R	Blue	•	•	•	•
TR5362ISP	20	125	5-20R	Ivory	•	•	•	•
TR5362WSP	20	125	5-20R	White	•	•	•	•
TR5362SP	20	125	5-20R	Brown	•	•	•	•
TR5362GRYSP	20	125	5-20R	Gray	•	•	•	•
TR5362BKSP	20	125	5-20R	Black	•	•	•	•
TR5362LASP	20	125	5-20R	Light Almond	•	•	•	•
TR5362BLSP	20	125	5-20R	Blue	•	•	•	•
ISOLATED GROUND DUPLEX RECEPTACLES BACK & SIDE WIRE								
TRIG5262WSP	15	125	5-15R	White	•	•	•	•
TRIG5262BLSP	15	125	5-15R	Blue	•	•	•	•
TRIG5262OSP	15	125	5-15R	Orange	•	•	•	•
TRIG5362WSP	20	125	5-20R	White	•	•	•	•
TRIG5362LASP	20	125	5-20R	Light Almond	•	•	•	•
TRIG5362OSP	20	125	5-20R	Orange	•	•	•	•

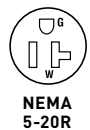
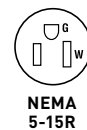

SURGE PROTECTIVE & ISOLATED GROUND DEVICES

All devices listed on this page conform to NEMA WD-1 and WD-6. Conforms to the latest revision ANSI/IEEE C62.41 (formerly IEEE587), ANSI/IEEE C62.45.

SURGE PROTECTIVE & ISOLATED GROUND DEVICES

Isolated Ground Receptacle

TRIG8300WSP

Isolated Ground Receptacle

- A. IG symbol and Isolated Ground markings** on strap make for easy identification and circuit delineation.
- B. Dual mechanical shutter system** to help prevent insertion of foreign objects.
- C. Solid-state LED monitor has 25-year minimum life expectancy.** A high visibility, wide-angle lens indicates protection is in place.
- D. Wrap-around steel strap** for structural integrity. Auto-ground is standard, for easier installation.
- E. Impact-resistant thermoplastic exterior** resists impacts and scrapes.
- F. External screw-pressure-plate back and side wire terminals including ground with external back wire clamps (exclusive)** accept #14 – #10 AWG copper or copper-clad, solid or stranded conductors. External pressure plate feature allows two conductors to be terminated by a single screw.
- G. Triple-wipe, copper-alloy contacts** for superior, more dependable connection.

LED indication: Steady green = protected
 Flashing red = not protected
 OFF = no power to unit

Plastic barrier isolates grounding terminal from mounting strap and metal boxes.

Audible alarm alert of MOV damage. Alarm able to be turned On/Off.

Thermal protection in 3 modes. 3 17mm dual pack MOVs absorb up to 340 Joules of excess energy in each leg (L-N, L-G, N-G) with 24,000 amp current handling capability for full, equal and symmetrical protection. Protection response time in less than one nanosecond.

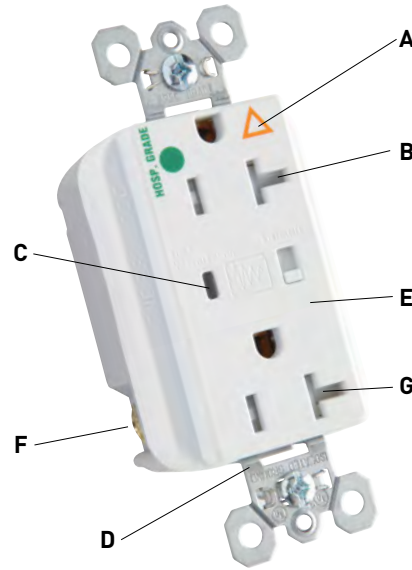

TRIG8300WSP

SURGE PROTECTIVE & ISOLATED GROUND DEVICES

Tamper-Resistant Hospital Grade Surge Protective Receptacles 2 Pole, 3 Wire Grounding, 15 & 20A, 125VAC

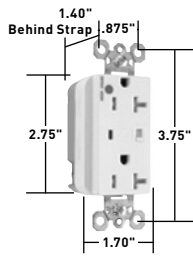

TR8300WSP

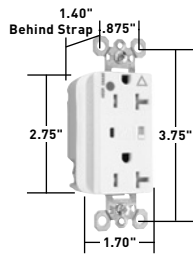

TRIG8300WSP

Audible Alarm with LED Indicator

CATALOG NUMBER	RATING		NEMA CONFIG. NO.	COLOR	3rd PARTY COMPLIANCE			
	A.	VAC			UL1449	UL498	FSUL WC596	cUL/CSA
EXTRA HEAVY-DUTY DUPLEX RECEPTACLES BACK & SIDE WIRE								
TR8200WSP	15	125	5-15R	White	•	•	•	•
TR8200SP	15	125	5-15R	Brown	•	•	•	•
TR8200REDSP	15	125	5-15R	Red	•	•	•	•
TR8200LASP	15	125	5-15R	Light Almond	•	•	•	•
TR8300ISP	20	125	5-20R	Ivory	•	•	•	•
TR8300WSP	20	125	5-20R	White	•	•	•	•
TR8300REDSP	20	125	5-20R	Red	•	•	•	•
TR8300BLSP	20	125	5-20R	Blue	•	•	•	•
ISOLATED GROUND DUPLEX RECEPTACLES BACK & SIDE WIRE								
TRIG8200WSP	15	125	5-15R	White	•	•	•	•
TRIG8200REDSP	15	125	5-15R	Red	•	•	•	•
TRIG8200BLSP	15	125	5-15R	Blue	•	•	•	•
TRIG8300ISP	20	125	5-20R	Ivory	•	•	•	•
TRIG8300WSP	20	125	5-20R	White	•	•	•	•
TRIG8300REDSP	20	125	5-20R	Red	•	•	•	•
TRIG8300BLSP	20	125	5-20R	Blue	•	•	•	•
TRIG8300OSP	20	125	5-20R	Orange	•	•	•	•

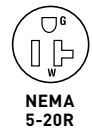
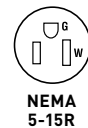

SURGE PROTECTIVE & ISOLATED GROUND DEVICES

All devices listed on this page conform to NEMA WD-1 and WD-6.
Conforms to the latest revision ANSI/IEEE C62.41 (formerly IEEE587), ANSI/IEEE C62.45.

SURGE PROTECTIVE & ISOLATED GROUND DEVICES

Product Description – Isolated Ground Straight Blade & Turnlok®

The Problem of Electromagnetic Interference

Reduction of electromagnetic interference (EMI) in the electrical grounding system is essential for proper operation of many types of electronic equipment. In conventional grounding circuits, the conduit system is used as the grounding path. The conduit system is grounded at the service entrance and connected to intervening sub-panels, structural steel, and other grounded equipment. Although this will provide personnel and equipment

protection, the entire conduit system becomes a large antenna which collects EMI (i.e., electrical noise) and transmits it throughout the grounding system. Whenever that occurs, the signals may adversely affect the performance of personal and small business computers, electronic testing and calibration equipment, and solid-state cash registers.

The Legrand® Solution: Pass & Seymour® Isolated Ground Receptacles

By running an insulated equipment grounding conductor directly to the neutral at the service entrance, and installing P&S Isolated Ground Receptacles, you effectively isolate the grounding circuit from the conduit grounding system. This significantly reduces the size of the antenna

and limits the amount of EMI that can be picked up in the isolated grounding system. This provides a relatively noise-free grounding path and improves the operation of electronic equipment.

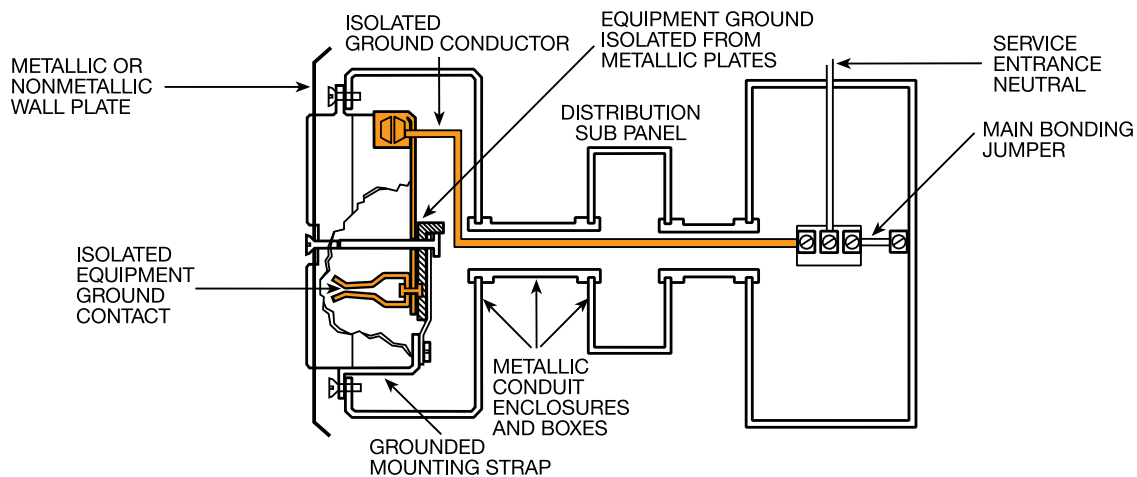

2014 National Electrical Code® Section 250.146(D) Isolated Ground Receptacles

Where installed for the reduction of electrical noise (electromagnetic interference) on the grounding circuit, a receptacle in which the grounding terminal is purposely insulated from the receptacle mounting means shall be permitted. The receptacle grounding terminal shall be connected to an insulated equipment grounding conductor run with the circuit conductors. This equipment grounding conductor shall be permitted to pass through one or more panelboards without a connection to the panelboard

grounding terminal bar as permitted in Section 408.40, Exception, so as to terminate within the same building or structure directly at an equipment grounding conductor terminal of the applicable derived system or service. Where installed in accordance with the provisions of this section, this equipment grounding conductor shall also be permitted to pass through boxes, wireways, or other enclosures without being connected to such enclosures.

2014 National Electrical Code® Section 406.3(D) Isolated Ground Receptacles

Receptacles incorporating an isolated grounding conductor connection intended for the reduction of electrical noise (electromagnetic interference) as permitted in Section

250.146(D), shall be identified by an orange triangle located on the face of the receptacle.

SURGE PROTECTIVE & ISOLATED GROUND DEVICES

Isolated Ground Receptacles

PTIG5362LA**PlugTail® Isolated Ground Receptacle**

- A. Auto-ground clip** assures positive ground.
 - B. Plastic barrier isolates grounding terminal** from mounting strap and metal boxes.
 - C. .036 inch thick, brass, triple-wipe power contacts** for lasting retention.
 - D. Plated steel wrap strap design** for maximum durability and corrosion resistance.
 - E. Built-in connector** features large brass terminal blades to ensure consistent, reliable electrical connections.
 - F. No exposed terminals** create a finger safe application before, during, and after installation.
 - G. Large brass contacts** snugly terminate on device blade terminals. Audible snapping latch assures connection, allows release.
 - H. Ultrasonically welded polycarbonate connector housing** secures terminations and conductors in a UL Listed, finger safe housing.
 - I. Pre-stripped connector leads** fasten to conductors, easier than standard pigtails.
- Three drive screws** anchor strap to back body and face.

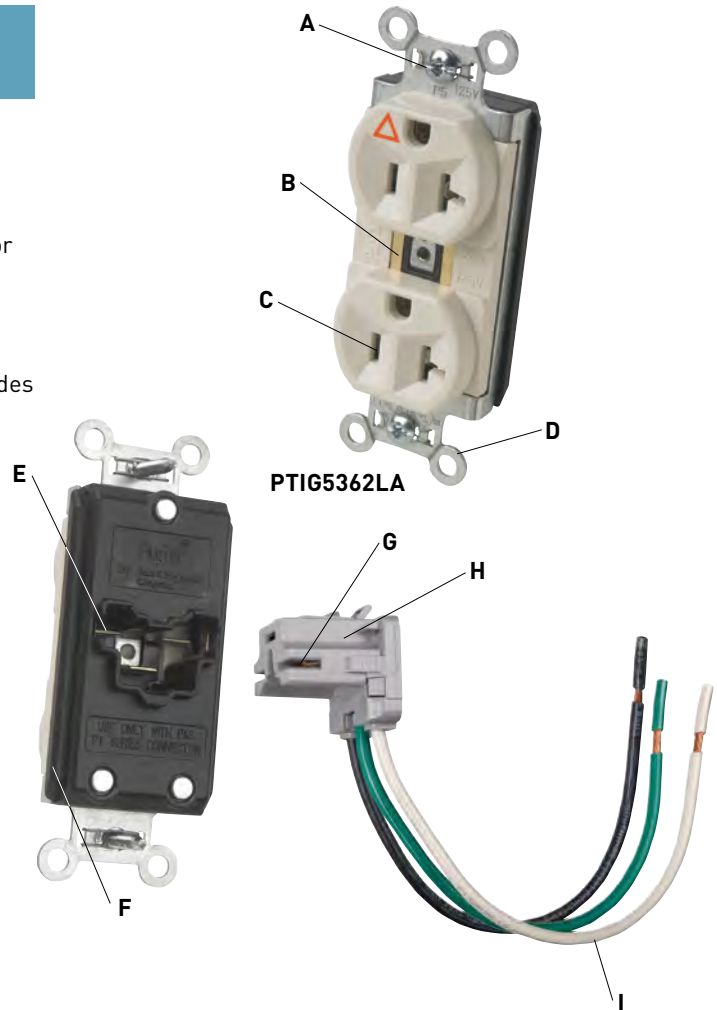
**IG5262****Isolated Ground Receptacle**

- A. IG symbol and Isolated Ground markings** for easy identification and circuit delineation.
 - B. Triple-wipe brass contacts** ensure lasting, positive contact with plug blades.
 - C. High-impact resistant nylon face** resists impacts and scrapes.
 - D. Corrosion-resistant plated steel strap.**
 - E. Patented feature, external screw-pressure-plate back wire clamp on ground terminal** for faster, easier installation.
 - F. Side and internal screw-pressure plate back wire capability** with #14 - #10 AWG copper or copper-clad, solid or stranded wire.
 - G. Auto-ground clip** assures positive ground.
- Plastic barrier isolates grounding terminal** from mounting strap and metal boxes.

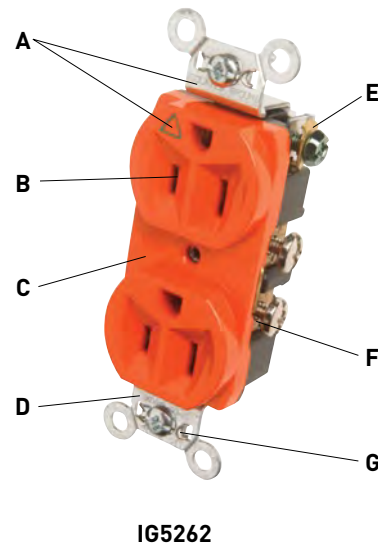
**IG5262**

SURGE PROTECTIVE & ISOLATED GROUND DEVICES

PlugTail® Isolated Ground Receptacles 2 Pole, 3 Wire Grounding, 15 & 20A, 125V



Features

- .036 inch thick brass triple wire contacts for lasting retention.
- Impact-resistant nylon face.
- Corrosion-resistant plated steel wrap strap for increased rigidity and strength.
- Auto-ground clip assures positive ground.
- No exposed terminals for a finger safe application.
- Ultrasonically welded polycarbonate connector housing secures terminations in a UL Listed finger safe housing.
- Pre-stripped connector leads.
- Nylon isolator plate for isolating ground from strap and box system.
- Crimped and welded contacts.

CATALOG NUMBER		RATING		NEMA CONFIG. NO.	COLOR	3rd PARTY COMPLIANCE	
SPEC GRADE	HOSPITAL GRADE	A.	V.			UL 498	FSUL WC596
DUPLEX RECEPTACLES							
PTIG5262W		15	125	5-15R	White	•	•
PTIG5262	PTIG8200	15	125	5-15R	Orange	•	•
PTIG5262RED	PTIG8200RED	15	125	5-15R	Red	•	•
PTIG5262LA		15	125	5-15R	Light Almond	•	•
PTIG5362I	PTIG8300I	20	125	5-20R	Ivory	•	•
PTIG5362W		20	125	5-20R	White	•	•
PTIG5362	PTIG8300	20	125	5-20R	Orange	•	•
PTIG5362GRY		20	125	5-20R	Gray	•	•
PTIG5362RED	PTIG8300RED	20	125	5-20R	Red	•	•
PTIG5362LA		20	125	5-20R	Light Almond	•	•

CATALOG NUMBER	RATING		NEMA CONFIG. NO.	COLOR	3rd PARTY COMPLIANCE	
	A.	V.			UL 498	FSUL WC596
DECORATOR DUPLEX RECEPTACLES						
PTIG26262W	15	125	5-15R	White	•	•
PTIG26262	15	125	5-15R	Orange	•	•
PTIG26262RED	15	125	5-15R	Red	•	•
PTIG26362I	20	125	5-20R	Ivory	•	•
PTIG26362W	20	125	5-20R	White	•	•
PTIG26362	20	125	5-20R	Orange	•	•
PTIG26362GRY	20	125	5-20R	Gray	•	•

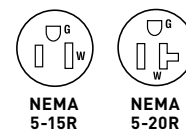

CATALOG NUMBER	WIRE TYPE	WIRE LENGTH
PLUGTAIL CONNECTORS – RIGHT ANGLE		
PTRA6STR	Stranded	6"
PTRA6SOL	Solid	6"

For additional PlugTail Connectors, see Page B-4.

All PlugTail Connectors are available in any wire length up to 25 inches, consult factory to order.

For Bulk Packaging Solutions consult factory.

SURGE PROTECTIVE & ISOLATED GROUND DEVICES

Isolated Ground Receptacles 2 Pole, 3 Wire Grounding 15 & 20A, 125 & 250V

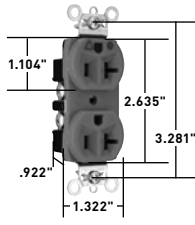

IG8300

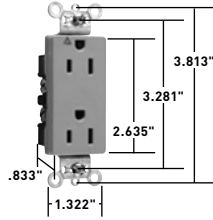

IG2626GRY

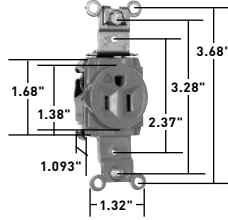

IG5261

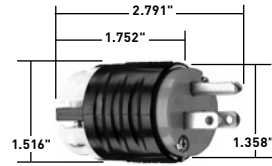

PSIG5266X

CATALOG NUMBER		RATING		NEMA CONFIG. NO.	COLOR	3rd PARTY COMPLIANCE		
SPEC GRADE	HOSPITAL GRADE	A.	V.			UL498	FSUL WC596	C22.2 No. 42
DUPLEX RECEPTACLES BACK & SIDE WIRE								
IG5262I	IG8200I	15	125	5-15R	Ivory	•	•	•
IG5262W		15	125	5-15R	White	•	•	•
IG5262	IG8200	15	125	5-15R	Orange	•	•	•
IG5262GRY		15	125	5-15R	Gray	•	•	•
IG5262RED	IG8200RED	15	125	5-15R	Red	•	•	•
IG5262LA		15	125	5-15R	Light Almond	•	•	•
IG5362I	IG8300I	20	125	5-20R	Ivory	•	•	•
IG5362W	IG8300W	20	125	5-20R	White	•	•	•
IG5362	IG8300	20	125	5-20R	Orange	•	•	•
IG5362GRY		20	125	5-20R	Gray	•	•	•
IG5362BK		20	125	5-20R	Black	•	•	•
IG5362RED	IG8300RED	20	125	5-20R	Red	•	•	•
IG5362LA	IG8300LA	20	125	5-20R	Light Almond	•	•	•
IG5662		15	250	6-15R	Orange	•	•	•
IG5862	IG8800	20	250	6-20R	Orange	•	•	•
	IG8800LA	20	250	6-20R	Light Almond	•	•	•
DECORATOR DUPLEX RECEPTACLES BACK & SIDE WIRE								
IG26262I		15	125	5-15R	Ivory	•	•	•
IG26262W	IG26262HGW	15	125	5-15R	White	•	•	•
IG26262	IG26262HG	15	125	5-15R	Orange	•	•	•
IG26262GRY		15	125	5-15R	Gray	•	•	•
IG26262BK		15	125	5-15R	Black	•	•	•
	IG26262HGRED	15	125	5-15R	Red	•	•	•
IG26362I		20	125	5-20R	Ivory	•	•	•
IG26362W	IG26362HGW	20	125	5-20R	White	•	•	•
IG26362	IG26362HG	20	125	5-20R	Orange	•	•	•
IG26362GRY		20	125	5-20R	Gray	•	•	•
IG26362BK	IG26362HGBK	20	125	5-20R	Black	•	•	•
IG26362RED	IG26362HGRED	20	125	5-20R	Red	•	•	•
IG26362LA		20	125	5-20R	Light Almond	•	•	•
SINGLE RECEPTACLES BACK & SIDE WIRE								
IG5261		15	125	5-15R	Orange	•	•	•
IG5361	IG8301	20	125	5-20R	Orange	•	•	•

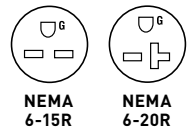
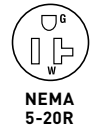
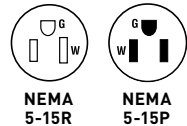

CATALOG NUMBER	RATING		NEMA CONFIG. NO.	CORD DIAMETER	3rd PARTY COMPLIANCE		
	A.	V.			UL498	FSUL WC596	C22.2 No. 42
STRAIGHT BLADE PLUGS, ORANGE							
PSIG5266X	15	125	5-15P	.230" - .720"	•	•	•

Consult Straight Blade Section G for complete line of Straight Blade Plugs & Connectors.

For Wall Plates for Isolated Ground Systems, consult Wall Plates Section S.

For Bulk Packaging Solutions consult factory.

All devices listed on this page conform to NEMA WD-1 and WD-6.

SURGE PROTECTIVE & ISOLATED GROUND DEVICES

Tamper-Resistant Isolated Ground Receptacles 2 Pole, 3 Wire Grounding 15 & 20A, 125V

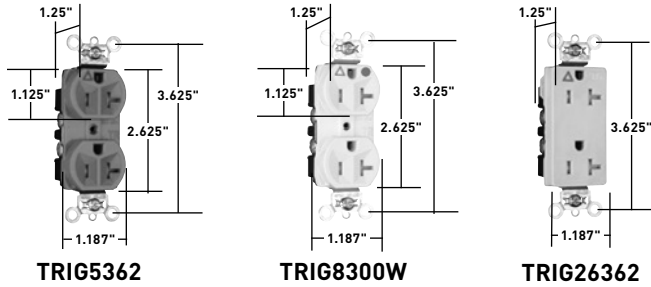

CATALOG NUMBER		RATING		NEMA CONFIG. NO.	COLOR	3rd PARTY COMPLIANCE	
SPEC GRADE	HOSPITAL GRADE	A.	V.			UL US UL498	FSUL WC596
TAMPER-RESISTANT DUPLEX RECEPTACLES BACK & SIDE WIRE							
TRIG5262I	TRIG8200I	15	125	5-15R	Ivory	•	•
TRIG5262W	TRIG8200W	15	125	5-15R	White	•	•
TRIG5262	TRIG8200	15	125	5-15R	Orange	•	•
TRIG5262BK	TRIG8200BK	15	125	5-15R	Black	•	•
TRIG5262GRY	TRIG8200GRY	15	125	5-15R	Gray	•	•
	TRIG8200RED	15	125	5-15R	Red	•	•
TRIG5262LA	TRIG8200LA	15	125	5-15R	Light Almond	•	•
TRIG5362I	TRIG8300I	20	125	5-20R	Ivory	•	•
TRIG5362W	TRIG8300W	20	125	5-20R	White	•	•
TRIG5362	TRIG8300	20	125	5-20R	Orange	•	•
TRIG5362BK	TRIG8300BK	20	125	5-20R	Black	•	•
TRIG5362GRY	TRIG8300GRY	20	125	5-20R	Gray	•	•
TRIG5362RED	TRIG8300RED	20	125	5-20R	Red	•	•
TRIG5362LA	TRIG8300LA	20	125	5-20R	Light Almond	•	•
TAMPER-RESISTANT DECORATOR RECEPTACLES BACK & SIDE WIRE							
TRIG26262I	TRIG26262HGI	15	125	5-15R	Ivory	•	•
TRIG26262W	TRIG26262HGW	15	125	5-15R	White	•	•
TRIG26262		15	125	5-15R	Orange	•	•
TRIG26262BK	TRIG26262HGBK	15	125	5-15R	Black	•	•
TRIG26262GRY	TRIG26262HGGRY	15	125	5-15R	Gray	•	•
	TRIG26262HGRED	15	125	5-15R	Red	•	•
TRIG26262LA	TRIG26262HGLA	15	125	5-15R	Light Almond	•	•
TRIG26362I	TRIG26362HGI	20	125	5-20R	Ivory	•	•
TRIG26362W	TRIG26362HGW	20	125	5-20R	White	•	•
TRIG26362	TRIG26362HG	20	125	5-20R	Orange	•	•
TRIG26362BK	TRIG26362HGBK	20	125	5-20R	Black	•	•
TRIG26362GRY	TRIG26362HGGRY	20	125	5-20R	Gray	•	•
	TRIG26362HGRED	20	125	5-20R	Red	•	•
TRIG26362LA	TRIG26362HGLA	20	125	5-20R	Light Almond	•	•

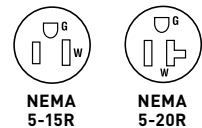

SURGE PROTECTIVE & ISOLATED GROUND DEVICES

For Bulk Packaging Solutions consult factory.

SURGE PROTECTIVE & ISOLATED GROUND DEVICES

Turnlok® Isolated Ground Receptacles 2 Pole, 3 Wire 15, 20 & 30A

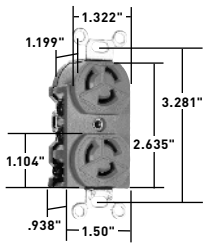

IG4700

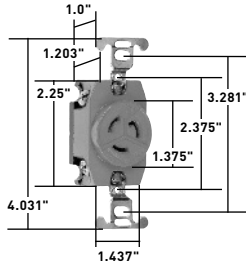

IG4710

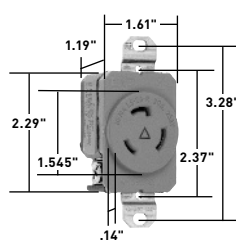

20 Amp Receptacle

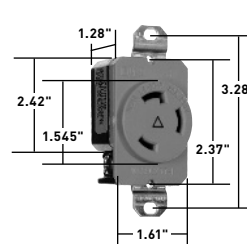

30 Amp Receptacle

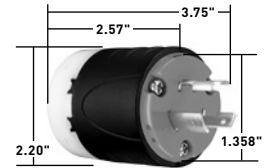

IGL620P

CATALOG NUMBER	RATING		NEMA CONFIG. NO.	COLOR	3rd PARTY COMPLIANCE	
	A.	V.			UL498	C22.2 No. 42
2 POLE, 3 WIRE GROUNDING, ORANGE BACK WIRE						
IG4700RED	15	125	L5-15R	Red	•	•
IG4700	15	125	L5-15R	Orange	•	•
IG4710	15	125	L5-15R	Orange	•	•
IG4760	15	277	L7-15R	Orange	•	•
IGL520R	20	125	L5-20R	Orange	•	•
IGL620R	20	250	L6-20R	Orange	•	•
IGL720R	20	277	L7-20R	Orange	•	•
IGL820R	20	480	L8-20R	Orange	•	•
IGL530R	30	125	L5-30R	Orange	•	•
IGL630R	30	250	L6-30R	Orange	•	•
3 POLE, 4 WIRE GROUNDING, ORANGE BACK WIRE						
IGL1420R	20	125/250	L14-20R	Orange	•	•
IGL1520R	20	3ø, 250	L15-20R	Orange	•	•
IGL1620R	20	3ø, 480	L16-20R	Orange	•	•
IGL1430R	30	125/250	L14-30R	Orange	•	•
IGL1530R	30	3ø, 250	L15-30R	Orange	•	•
4 POLE, 5 WIRE GROUNDING, ORANGE BACK WIRE						
IGL2120R	20	3øY, 120/208	L21-20R	Orange	•	•
IGL2220R	20	3øY, 277/480	L22-20R	Orange	•	•
IGL2320R	20	3øY, 347/600	L23-20R	Orange	•	•
IGL2130R	30	3øY, 120/208	L21-30R	Orange	•	•
IGL2230R	30	3øY, 277/480	L22-30R	Orange	•	•
IGL2330R	30	3øY, 347/600	L23-30R	Orange	•	•

CATALOG NUMBER	RATING		NEMA CONFIG. NO.	CORD DIAMETER	3rd PARTY COMPLIANCE	
	A.	V.			UL498	C22.2 No. 42
TURNLOK® PLUGS, ORANGE						
IGL520P	20	125	L5-20P	.385" - 1.150"	•	•
IGL630P	30	250	L6-30P	.385" - 1.150"	•	•

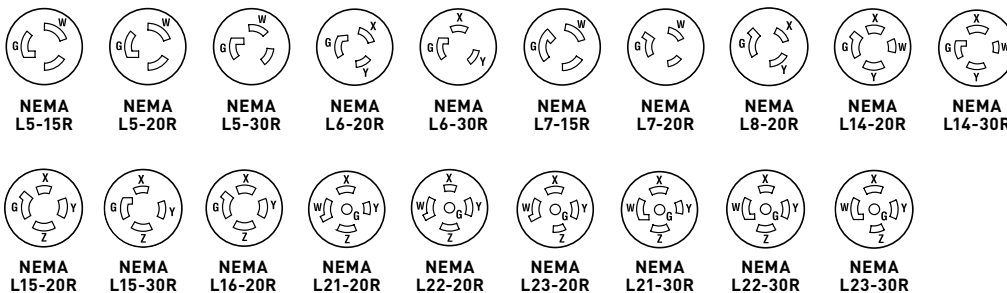

Consult Turnlok Section H for complete line of Turnlok Locking Devices. All devices listed on this page conform to NEMA WD-1 and WD-6.

SURGE PROTECTIVE & ISOLATED GROUND DEVICES

Power & Surge Protection Strips

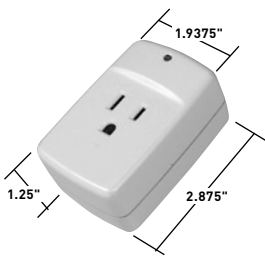

TAP - PS1

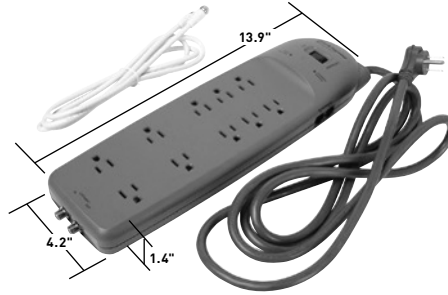

BLOCK - PS10PC

Application

There are an average of over 250 power disturbances per year in each home or office in the United States. Over 8% data loss is a direct result from lightning and the value of equipment and data is sometimes much greater than that of equipment.

Surges and spikes can come through power lines as well as phone and coax lines. So choose a protector which includes phone and/or coax protection.

Features

- 400V clamping voltage.
- UL1449 listed.
- Heavy-duty cord from 3' to 15', depending on device.
- Multiple function protection available for power, phone, fax, modem, coax or data.
- Extremely long life with dependable protection.
- Surge protection indicator on surge devices.
- Circuit breaker switch.
- Heavy-duty high-energy MOVs.
- Ground continuity indicator.

Protection Specifications

- Line protection modes: L-N, L-G, N-G.
- Spike protection for sudden, dramatic surges, over 400V.
- Surge protection lasts for 1/120 of a second, for moderate short term overvoltage.
- EMI/RFI noise attenuation.

CATALOG NUMBER	RATING		TYPE OF HOUSING	# OF OUTLETS	CORD LENGTH	JOULE RATING RANGE	MAX. SPIKE CURRENT (AMPS)	TYPE OF PROTECTION		COLOR
	A.	V.						PHONE/FAX	COAX	
POWER STRIPS WITH SURGE PROTECTION										
PS1	15	125	Tap	1		740J	48K			PC Gray
PS6	15	125	Strip	6	3'	555J	36K			PC Gray
PS7	15	125	Strip	7	6'	740J	48K			PC Gray
PS7P	15	125	Strip	7	6'	740J	48K	X		PC Gray
PS7L	15	125	Strip	7	15'	740J	48K			PC Gray
PS8C	15	125	Block	8	8'	1100J	72K		X	PC Gray
PS8P	15	125	Block	8	8'	1100J	72K	X		PC Gray
PS10PC	15	125	Block	10	8'	1100J	72K	X	X	PC Gray

SURGE PROTECTIVE & ISOLATED GROUND DEVICES

Surge Protection Strips Specifications

Power & Surge Protection Devices – Ratings

Catalog Number	PS1	PS6	PS7	PS7P	PS7L	PS8C	PS8P	PS10PC
Type of Housing	Tap	Strip	Strip	Strip	Strip	Block	Block	Block
Number of Outlets	1	6	7	7	7	8	8	10
Standard Grounded Outlets	1	6	6	6	6	0	0	6
Transformer Ready Outlets	1	0	1	1	1	8	8	4
Joule Rating Range	740J	555J	740J	740J	740J	1100J	1100J	1100J
MOV Configuration	4-20mm	3-20mm	4-20mm	4-20mm	4-20mm	6-20mm	6-20mm	6-20mm
Clamping Voltage	400V	400V	400V	400V	400V	400V	400V	400V
Max. Spike Current (Amps)	48K	36K	48K	48K	48K	72K	72K	72K
EMI Filter Capacitors	X		X	X	X	X	X	X
Protection (L-N, L-G, N-G)	X	X	X	X	X	X	X	X
Surge Protection Indicator	X	X	X	X	X	X	X	X
Ground/Wiring Indicator			X	X	X	X	X	X
Circuit Breaker Switch		Unlighted	Lighted	Lighted	Lighted	Lighted	Lighted	Lighted
Cord Length (exposed) ft.		3'	6'	6'	15'	8'	8'	8'
Plug		Straight	Straight	Straight	Straight	Rt. Angle	Rt. Angle	Rt. Angle
Phone/Fax Protection				X			X	X
Phone Line(s) Configuration				1 in/1 out			1 in/2 out	1 in/1 out
Phone Jack Spec				RJ-11			RJ-45	RJ-45
Nickel-Coaxial Jack Protection						X		X
6' Phone Cable (6P2C)				X			X	X
6' Coax Cable (Nickel Plated)						X		X
Molded Add-On Safety Covers	0	0	2	2	2	4	4	5
Molded Housing Color	PC Gray	PC Gray	PC Gray	PC Gray	PC Gray	PC Gray	PC Gray	PC Gray
UL1449 2nd Edition	X	X	X	X	X	X	X	X

STRAIGHT BLADE PLUGS & CONNECTORS



Ready-to-wire and ready-to-perform under adverse plant conditions — our Straight Blade Plug & Connector line is an industrial-strength, on-the-job asset.

Featured Products



EXTRA-HARD USE (EHU)
SPECIFICATION
GRADE

G-5



EHU GROUND CONTINUITY
MONITORING (GCM)
PLUGS &
CONNECTORS

G-7



CLAMP-LOCK
DEVICES

G-13

NEMA Configurations	G-3	Medium-Duty Devices	G-9
Hospital Grade	G-4	Flanged Inlets & Outlets	G-10
Extra-Hard Use Specification Grade	G-2, G-5	Miscellaneous Configurations	G-11
Extra-Hard Use Angled Devices	G-6	Gator Grip Devices	G-12
Extra-Hard Use Ground Continuity Monitoring	G-7	Clamp-Lock™ Devices	G-13
MaxGrip® M ³	G-8	Product Specifications & Performance	G-14

STRAIGHT BLADE PLUGS & CONNECTORS

PS5266X & PS5269X Straight Blade Plugs & Connectors - EHU

- A. Quick-thread assembly screws** and cord-grip screws come backed-out, ready-to-wire.
- B. See-through, thermoplastic terminal chamber** for clear view of terminals and wire connections.
- C. Tapered wire wells** guide conductors into captivated, staked clamping nuts.
- D. Housing is keyed** for fast alignment with terminal section.
- E. Chemical- and impact-resistant nylon housing** features horizontal, easy-grip ribs on back body.
- F. Industrial-strength, brass alloy plug blades** and connector contacts resist heat rise, provide excellent conductivity; ground pin is reinforced for added strength and safety.
- G. Color-coded terminal screws** are positioned on same plane and backed-out for fast installation.
- H. Double-wipe, firm-grip ground contact and triple-wipe power contacts** guarantee a superior connection.
- I. Recessed cord-grip screw** reduces screwdriver slippage, improves safety.
- J. Rugged external two-piece cord grip** provides uniform pressure for superior retention of conductors.
- K. Internal dust shield** keeps terminals free of contaminants.

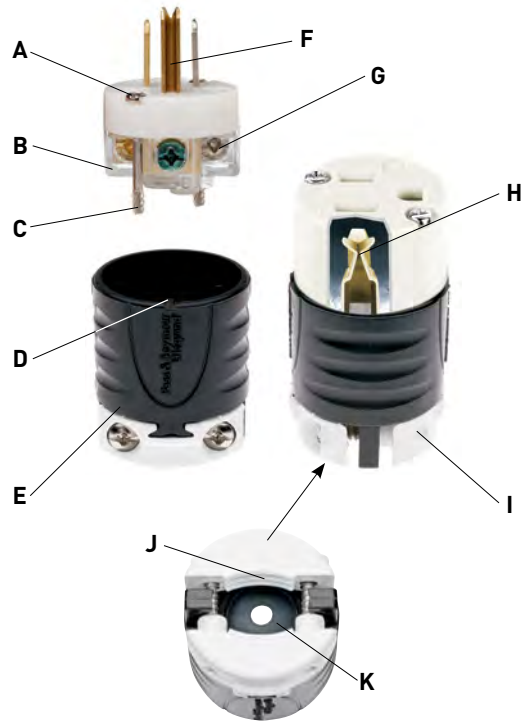

STRAIGHT BLADE PLUGS & CONNECTORS

NEMA Configurations

Straight Blade Plugs & Receptacles

	15 Ampere		20 Ampere		30 Ampere		50 Ampere		60 Ampere	
	Receptacle	Plug	Receptacle	Plug	Receptacle	Plug	Receptacle	Plug	Receptacle	Plug
2 POLE, 2 WIRE NON-GROUNDING										
125V	1	1-15R	1-15P							
	2									
250V										
2 POLE, 3 WIRE GROUNDING										
125V	5	5-15R	5-15P	5-20R	5-20P	5-30R	5-30P	5-50R	5-50P	
	6	6-15R	6-15P	6-20R	6-20P	6-30R	6-30P	6-50R	6-50P	
277VAC	7	7-15R	7-15P	7-20R	7-20P	N/A	7-30P	N/A	7-50P	
3 POLE, 3 WIRE NON-GROUNDING										
125/250V	10			10-20R	10-20P	10-30R	10-30P	10-50R	10-50P	
3 POLE, 4 WIRE GROUNDING										
125/250V	14			14-20R	14-20P	14-30R	14-30P	14-50R	14-50P	N/A
3ø250V	15				15-20P	15-30R	15-30P	15-50R	15-50P	15-60R
4 POLE, 4 WIRE NON-GROUNDING										
3øY 120/208V	18			18-20R	18-20P					18-60R

Labels and Their Meanings

X, Y, Z	Hot Lead
W	Neutral Lead
G	Grounding Lead

Open Slots

Indicate receptacle configurations (female).



Closed Slots

Indicate plug blade configurations (male).

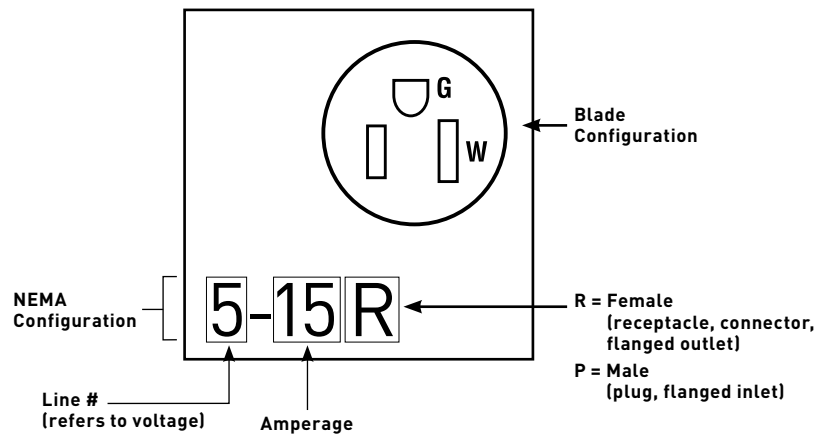

STRAIGHT BLADE PLUGS & CONNECTORS

IP20
Suitability

Hospital Grade Plugs & Connectors 2 Pole, 3 Wire Grounding 15 & 20A, 125 & 250V

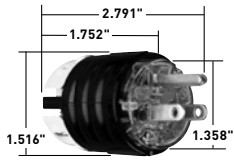

PS5266XHG

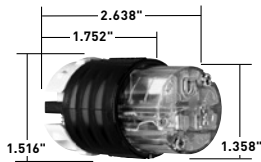

PS5269XHG



PS5266HGAN

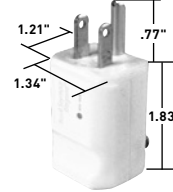

PS8115



PS8119

Features – Extra-Hard Use (EHU)

- Unit arrives completely ready-to-wire, cuts installation time significantly.
- Nylon housing provides impact and chemical resistance.
- Rugged two-piece cord grip provides more uniform cord retention.
- Internal dust shield keeps terminals free of contaminants.
- Tri-drive assembly screws are standard on Hospital Grade plugs and connectors [angle plugs not included].
- All 3-wire terminals located on the same plane, allows for quick wire termination from any angle.
- Heavy-duty brass alloy blades and contacts, resist heat rise, provide excellent conductivity.
- Cord-grip screws recessed to protect installer against screwdriver head slippage.

CATALOG NUMBER	RATING		DESCRIPTION	CORD DIAMETER	NEMA CONFIG. NO.	3rd PARTY COMPLIANCE		
	A.	V.				UL498	FSUL WC596	CSB C22.2 No. 42
HOSPITAL GRADE – EXTRA-HARD USE (EHU)								
PS5266XHG	15	125	Plug, Black & Clear	.230"-.720"	5-15P	•	•	•
PS5266HGAN	15	125	Angle Plug, Black & Clear	.320"-.655"	5-15P	•	•	•
PS5269XHG	15	125	Connector, Black & Clear	.230"-.720"	5-15R	•	•	•
PS5366XHG	20	125	Plug, Black & Clear	.230"-.720"	5-20P	•	•	•
PS5366HGAN	20	125	Angle Plug, Black & Clear	.320"-.655"	5-20P	•	•	•
PS5369XHG	20	125	Connector, Black & Clear	.230"-.720"	5-20R	•	•	•
PS5666XHG	15	250	Plug, Black & Clear	.230"-.720"	6-15P	•	•	•
PS5666HGAN	15	250	Angle Plug, Black & Clear	.320"-.655"	6-15P	•	•	•
PS5669XHG	15	250	Connector, Black & Clear	.230"-.720"	6-15R	•	•	•
PS5466XHG	20	250	Plug, Black & Clear	.230"-.720"	6-20P	•	•	•
PS5466HGAN	20	250	Angle Plug, Black & Clear	.320"-.655"	6-20P	•	•	•
PS5469XHG	20	250	Connector, Black & Clear	.230"-.720"	6-20R	•	•	•
HOSPITAL GRADE MAXGRIP® M³								
PS8115	15	125	Plug, White	.230"-.720"	5-15P	•	•	•
PS8119	15	125	Connector, White	.230"-.720"	5-15R	•	•	•
PS8115BK	15	125	Plug, Black	.230"-.720"	5-15P	•	•	•
PS8119BK	15	125	Connector, Black	.230"-.720"	5-15R	•	•	•

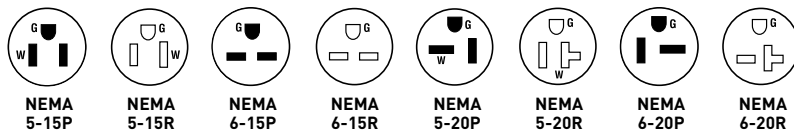

CATALOG NUMBER	DESCRIPTION
ACCESSORIES	
EHU15AN	15 & 20A EHU Straight Blade, Right Angle Adapter
FC22GL	EHU-Strain Relief Grip*
FC30GL	EHU-Strain Relief Grip*
FC40GL	EHU-Strain Relief Grip*
FC52GL	EHU-Strain Relief Grip*



FC52GL

*For further information consult the Flexcor® Section K.

All devices listed on this page conform to NEMA WD-1 and WD-6.

STRAIGHT BLADE PLUGS & CONNECTORS

IP20
Suitability

Extra-Hard Use (EHU) Specification Grade 2 Pole, 3 Wire Grounding 15 & 20A, 125, 250 & 277V

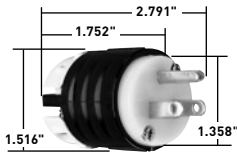

PS5266X

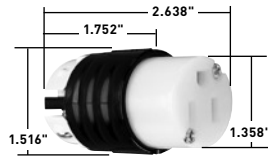

PS5269X

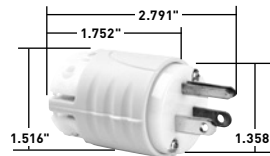

CR5266X

Features – Extra-Hard Use (EHU)

- Unit arrives completely ready-to-wire, cuts installation time significantly.
- Nylon housing provides impact and chemical resistance.
- Rugged two-piece cord grip provides more uniform cord retention.
- Internal dust shield keeps terminals free of contaminants.
- Tri-drive assembly screws are standard on all Specification Grade plugs and connectors.
- All 3-wire terminals located on the same plane, allows for quick wire termination from any angle.
- Heavy-duty brass alloy blades and contacts, resist heat rise, provide excellent conductivity.
- Cord-grip screws recessed to protect installer against screwdriver head slippage.

CATALOG NUMBER	RATING		DESCRIPTION	CORD DIAMETER	NEMA CONFIG. NO.	3rd PARTY COMPLIANCE		
	A.	V.				UL498	FSUL WC596	C22.2 No. 42
EHU – SPECIFICATION GRADE								
PS5266X	15	125	Plug, Black & White	.230"-.720"	5-15P	•		•
PS5266XGRY	15	125	Plug, Black & Gray	.230"-.720"	5-15P	•		•
PS5266XBK	15	125	Plug, Black	.230"-.720"	5-15P	•		•
CR5266X	15	125	Plug, Corrosion-Resistant, Yellow & White	.230"-.720"	5-15P	•		•
PS5269X	15	125	Connector, Black & White	.230"-.720"	5-15R	•		•
PS5269XGRY	15	125	Connector, Black & Gray	.230"-.720"	5-15R	•		•
PS5269XBK	15	125	Connector, Black	.230"-.720"	5-15R	•		•
CR5269X	15	125	Connector, Corrosion-Resistant, Yellow & White	.230"-.720"	5-15R	•		•
PS5366X	20	125	Plug, Black & White	.230"-.720"	5-20P	•	•	•
PS5369X	20	125	Connector, Black & White	.230"-.720"	5-20R	•	•	•
PS5666X	15	250	Plug, Black & White	.230"-.720"	6-15P	•	•	•
PS5669X	15	250	Connector, Black & White	.230"-.720"	6-15R	•	•	•
PS5466X	20	250	Plug, Black & White	.230"-.720"	6-20P	•	•	•
PS5469X	20	250	Connector, Black & White	.230"-.720"	6-20R	•	•	•
PS5766X	15	277	Plug, Black & White	.230"-.720"	7-15P	•		•
PS5866X*	20	277	Plug, Black & White	.385"-1.150"	7-20P	•		•

*For PS5866X right-angle applications, use L20303AN right-angle adapter.

CATALOG NUMBER	DESCRIPTION
ACCESSORIES	
EHU15AN	15 & 20A EHU Straight Blade, Right Angle Adapter
L15RBC	Weatherproof Boot-Connector**
L15RBP	Weatherproof Boot-Plug**
FC22GL	EHU-Strain Relief Grip†
FC30GL	EHU-Strain Relief Grip†
FC40GL	EHU-Strain Relief Grip†
FC52GL	EHU-Strain Relief Grip†

**For further information consult the Turnlok® Section H.
†For further information consult the Flexcor® Section K.

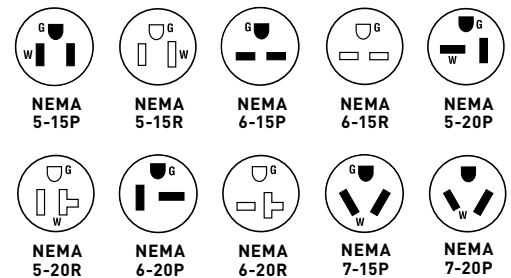

STRAIGHT BLADE PLUGS & CONNECTORS

IP20
Suitability

Extra-Hard Use (EHU) Angled Devices 2 Pole, 3 Wire Grounding 15 & 20A, 125 & 250V

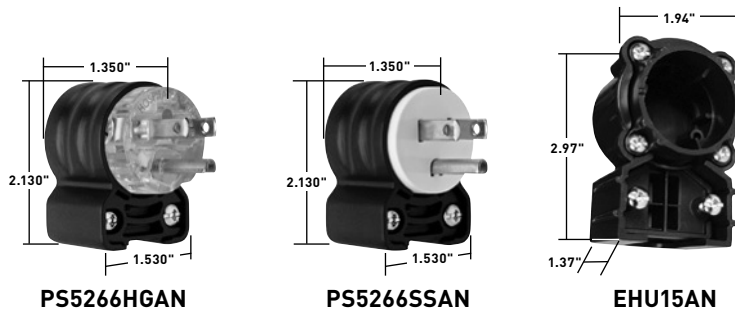

Features

- Angle plugs and adapters both allow for 4-position face rotation.
- Tri-drive assembly and cord-grip screws are standard on all angle adapters.
- Angle adapter (sold separately as catalog number EHU15AN) will accommodate all Pass & Seymour EHU-style Straight Blade plugs and connectors on a retrofit basis. Simply remove the straight handle body from the plug or connector face assembly, and replace with the angle adapter.

CATALOG NUMBER	RATING		DESCRIPTION	CORD DIAMETER	NEMA CONFIG. NO.	3rd PARTY COMPLIANCE		
	A.	V.				UL498	FSUL WC596	CSB C22.2 No. 42
EHU – HOSPITAL GRADE								
PS5266HGAN	15	125	Plug, Black & Clear	.320"-.655"	5-15P	•	•	•
PS5366HGAN	20	125	Plug, Black & Clear	.320"-.655"	5-20P	•	•	•
PS5666HGAN	15	250	Plug, Black & Clear	.320"-.655"	6-15P	•	•	•
PS5466HGAN	20	250	Plug, Black & Clear	.320"-.655"	6-20P	•	•	•
EHU – SPECIFICATION GRADE								
PS5266SSAN	15	125	Plug, Black & White	.320"-.655"	5-15P	•	•	•
PS5366SSAN	20	125	Plug, Black & White	.320"-.655"	5-20P	•	•	•
PS5666SSAN	15	250	Plug, Black & White	.320"-.655"	6-15P	•	•	•
PS5466SSAN	20	250	Plug, Black & White	.320"-.655"	6-20P	•	•	•

CATALOG NUMBER	DESCRIPTION
ACCESSORIES	
EHU15AN	15 & 20A EHU Straight Blade, Right Angle Adapter

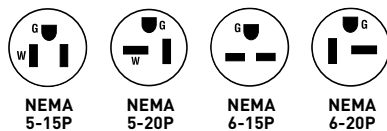

STRAIGHT BLADE PLUGS & CONNECTORS

STRAIGHT BLADE PLUGS & CONNECTORS

Extra-Hard Use Ground Continuity Monitoring (GCM) Plugs & Connectors 2 Pole, 3 Wire Grounding 15 & 20A, 125 & 250V

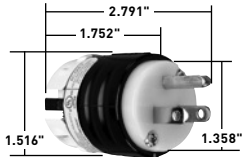

PS5266XGCM

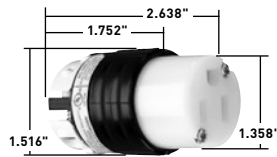

PS5269XGCM

Features – Extra-Hard Use (EHU) Straight Blade GCM

- Integral indication of ground continuity and power status. Continuous monitoring enhances personnel safety and adds convenience.
- Dual, bright LED indicators with 360° visibility. Green LEDs indicate proper ground continuity and power status. Red LEDs indicate ground continuity loss or reversed polarity. No LED indicates open hot, open neutral, or hot to ground cross. For 250V configurations: Hot to ground cross will be indicated by a green and red LED.
- Chemical- and impact-resistant nylon housing features horizontal, easy-grip ribs on back body.
- Exclusive two-piece cord grip accepts a wide range of cord widths. Provides more consistent pressure for superior conductor retention.
- Internal dust shield keeps terminals free of contaminants.
- Recessed cord-grip screw reduces screwdriver slippage, improves safety. Quick-thread tri-drive assembly and cord-grip screws come backed-out and ready-to-wire.
- Color-coded terminal screws are positioned on the same plane and backed-out for fast installation.
- Industrial-strength, brass alloy plug blades and connector contacts resist heat rise, provide excellent conductivity.

CATALOG NUMBER	RATING		DESCRIPTION	CORD DIAMETER	NEMA CONFIG. NO.	3rd PARTY COMPLIANCE	
	A.	V.				cULus	FSUL WC596
EHU – GCM							
PS5266XGCM	15	125	Plug, Black & White	.230"-.720"	5-15P	•	•
PS5269XGCM	15	125	Connector, Black & White	.230"-.720"	5-15R	•	•
PS5366XGCM	20	125	Plug, Black & White	.230"-.720"	5-20P	•	•
PS5369XGCM	20	125	Connector, Black & White	.230"-.720"	5-20R	•	•
PS5666XGCM	15	250	Plug, Black & White	.230"-.720"	6-15P	•	•
PS5669XGCM	15	250	Connector, Black & White	.230"-.720"	6-15R	•	•
PS5466XGCM	20	250	Plug, Black & White	.230"-.720"	6-20P	•	•
PS5469XGCM	20	250	Connector, Black & White	.230"-.720"	6-20R	•	•

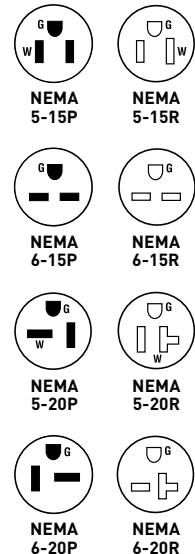

Green LED

Plug – There is proper ground continuity from the panel to the outlet and power is present.

Connector – Power is present and there is proper ground continuity throughout the cordset and back to the panel.



Red LED

Plug – Power is present, but there is a ground continuity fault or miswire between the receptacle and the panel.

Connector – Power is present, but there's a ground continuity fault or miswire in the cordset (or, if there's a red indication in the plug as well, between the receptacle and the panel). It's also possible there could be a problem in both.



No LED

Plug – Power loss, open hot or neutral conductor, or hot/ground reversal.

Connector – Assuming power is present at the outlet, there's an open hot or open neutral conductor in the cordset, or a hot/ground reversal.

250V products will show red and green when hot and ground are reversed.

STRAIGHT BLADE PLUGS & CONNECTORS

MaxGrip® M³ 2 Pole, 3 Wire Grounding 15 & 20A, 125 & 250V

PS5965Y & PS5969Y

Maxgrip® M³

- A. Enclosed terminals** provide solid, internally-clamped connections.
- B. Molded finger grips** promote safe, sure handling.
- C. Self-hinge** swings wide open to make quick, easy work of tight, clean connections. Insert conductors into terminals and tighten terminal screws; close hinge housing around cord and tighten housing screws.
- D. Tough nylon construction** with crush/impact resistance that exceeds hospital grade and Fed Spec requirements; arc resistance exceeds UL requirements.

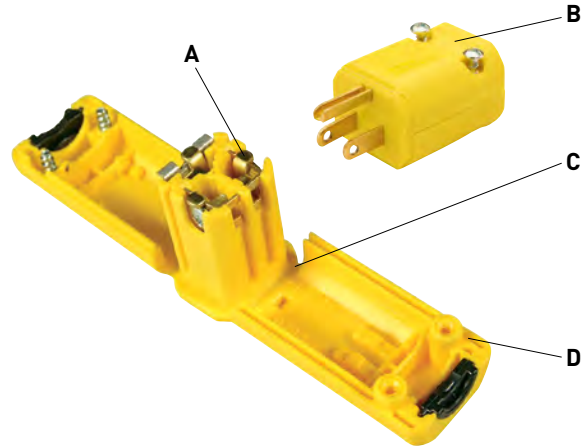

Hospital Grade version displays the Hospital Grade green dot.

High-visibility yellow and orange, or gray.

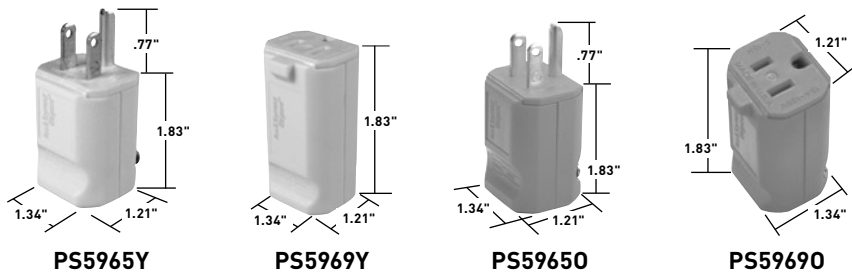

STRAIGHT BLADE PLUGS & CONNECTORS

CATALOG NUMBER	RATING		DESCRIPTION	CORD DIAMETER	NEMA CONFIG. NO.	3rd PARTY COMPLIANCE	
	A.	V.				cULus	FSUL WC596
HOSPITAL GRADE MAXGRIP® M³							
PS8115	15	125	Hospital Grade Plug, White	.230"-.720"	5-15P	•	•
PS8119	15	125	Hospital Grade Connector, White	.230"-.720"	5-15R	•	•
PS8115BK	15	125	Hospital Grade Plug, Black	.230"-.720"	5-15P	•	•
PS8119BK	15	125	Hospital Grade Connector, Black	.230"-.720"	5-15R	•	•
MAXGRIP M³							
PS5965Y	15	125	Plug, Yellow	.230"-.720"	5-15P	•	•
PS5965GRY	15	125	Plug, Gray	.230"-.720"	5-15P	•	•
PS5965O	15	125	Plug, Orange	.230"-.720"	5-15P	•	•
PS5965BK	15	125	Plug, Black	.230"-.720"	5-15R	•	•
PS5969Y	15	125	Connector, Yellow	.230"-.720"	5-15R	•	•
PS5969GRY	15	125	Connector, Gray	.230"-.720"	5-15R	•	•
PS5969O	15	125	Connector, Orange	.230"-.720"	5-15R	•	•
PS5969BK	15	125	Connector, Black	.230"-.720"	5-15R	•	•
PS5364Y	20	125	Plug, Yellow	.230"-.720"	5-20P	•	•
PS5364GRY	20	125	Plug, Gray	.230"-.720"	5-20P	•	•
PS5369Y	20	125	Connector, Yellow	.230"-.720"	5-20R	•	•
PS5369GRY	20	125	Connector, Gray	.230"-.720"	5-20R	•	•
PS5666Y	15	250	Plug, Yellow	.230"-.720"	6-15P	•	•
PS5669Y	15	250	Connector, Yellow	.230"-.720"	6-15R	•	•
PS5464Y	20	250	Plug, Yellow	.230"-.720"	6-20P	•	•
PS5469Y	20	250	Connector, Yellow	.230"-.720"	6-20R	•	•

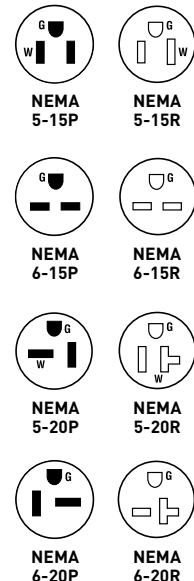

STRAIGHT BLADE PLUGS & CONNECTORS

IP20
Suitability

Medium-Duty Devices 2 Pole, 3 Wire Grounding 15 & 20A, 125 & 250V



Features

- All nylon construction, provides excellent impact and chemical resistance.
- Simple turn and twist assembly for quick installation.
- Ready-to-wire from factory, saves time and money.
- All black, perfect for stage and entertainment applications.
- Internal finger grips automatically adjust to securely grip the cord jacket.

CATALOG NUMBER	RATING		DESCRIPTION	CORD DIAMETER	NEMA CONFIG. NO.	3rd PARTY COMPLIANCE
	A.	V.				cULus UL498
DEAD FRONT PLUGS & CONNECTORS						
5276BK	15	125	Plug, Black	.230"-.655"	5-15P	•
5296BK	15	125	Connector, Black	.230"-.655"	5-15R	•
5765BK	20	125	Plug, Black	.230"-.655"	5-20P	•
5374BK	20	125	Connector, Black	.230"-.655"	5-20R	•
5666BK	15	250	Plug, Black	.230"-.655"	6-15P	•
5669BK	15	250	Connector, Black	.230"-.655"	6-15R	•
5864BK	20	250	Plug, Black	.230"-.655"	6-20P	•
5866BK	20	250	Connector, Black	.230"-.655"	6-20R	•

Features

- All nylon construction.
- Termination saddle clamps securely capture stranded wires.
- All yellow, perfect for high-visibility cords.
- External cord grips are one-size-fits-all, no inserts or flipping the clamps to fit the proper cord OD.

CATALOG NUMBER	RATING		DESCRIPTION	CORD DIAMETER	NEMA CONFIG. NO.	3rd PARTY COMPLIANCE
	A.	V.				cULus
MEDIUM-DUTY PLUGS & CONNECTORS						
4867Y	15	125	Plug, Yellow	.250-.600"	5-15P	•
4887Y	15	125	Connector, Yellow	.250-.600"	5-15R	•

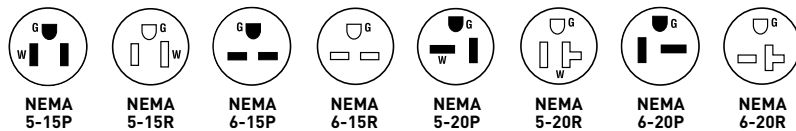

All devices listed on this page conform to NEMA WD-1 and WD-6.

STRAIGHT BLADE PLUGS & CONNECTORS

Flanged Inlets & Outlets 2 Pole, 3 Wire Grounding 15 & 20A, 125 & 250V

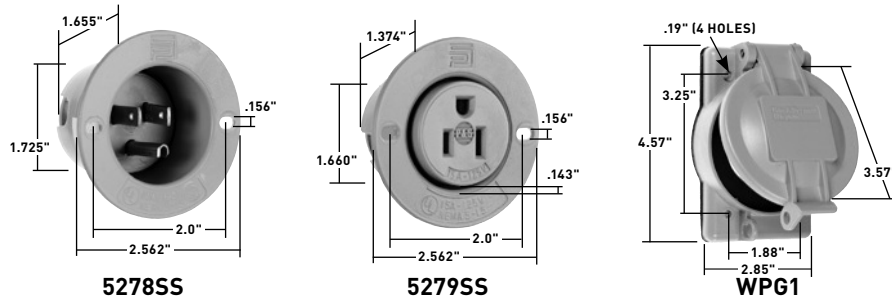

Features

- All thermoplastic construction, provides excellent impact and chemical resistance.
- Available in Gray or Black.
- NEMA configuration molded on flange, easy field identification.

CATALOG NUMBER	RATING		DESCRIPTION	NEMA CONFIG. NO.	3rd PARTY COMPLIANCE	
	A.	V.			UL498	FSUL WC596
FLANGED INLETS & OUTLETS – GRAY						
5278SS	15	125	Inlet, Gray	5-15P	•	•
5279SS	15	125	Outlet, Gray	5-15R	•	•
5378SS	20	125	Inlet, Gray	5-20P	•	•
5379SS	20	125	Outlet, Gray	5-20R	•	•
5678SS	15	250	Inlet, Gray	6-15P	•	•
5679SS	15	250	Outlet, Gray	6-15R	•	•
5478SS	20	250	Inlet, Gray	6-20P	•	•
5479SS	20	250	Outlet, Gray	6-20R	•	•

CATALOG NUMBER	RATING		DESCRIPTION	NEMA CONFIG. NO.	3rd PARTY COMPLIANCE	
	A.	V.			UL498	FSUL WC596
FLANGED INLETS & OUTLETS – BLACK						
5278SSBK	15	125	Inlet, Black	5-15P	•	•
5279SSBK	15	125	Outlet, Black	5-15R	•	•

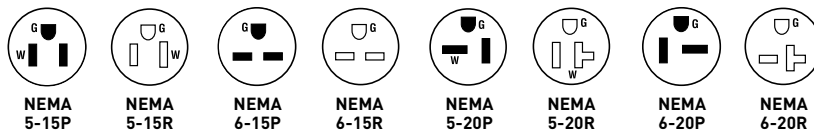

Features

- Glass-filled polycarbonate, impact- and corrosion-resistant.
- Stainless steel hardware.
- Molded-in flat surface label area.
- OSHA lock-out/tag-out provision molded-in.
- Accepts competitor inlets and outlets.

CATALOG NUMBER	DESCRIPTION
WEATHERPROOF COVER FOR FLANGED DEVICES	
WPG1	Weatherproof Cover for Flanged Inlets and Outlets

For further information consult the Weatherproof Section R.

STRAIGHT BLADE PLUGS & CONNECTORS

STRAIGHT BLADE PLUGS & CONNECTORS

IP20
Suitability

Miscellaneous Configurations

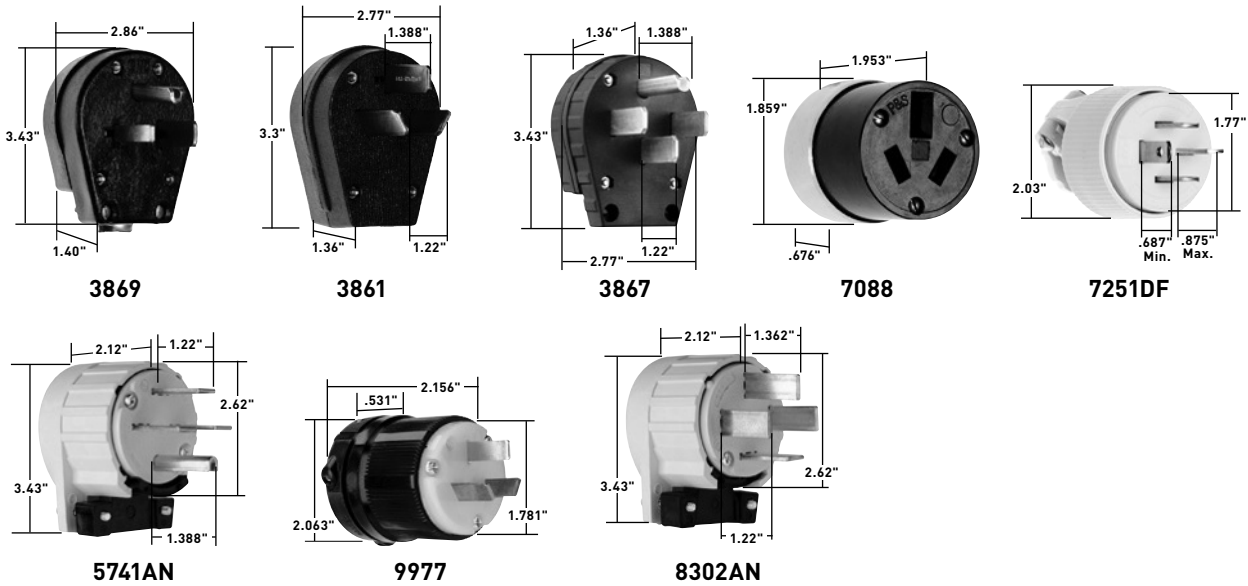

CATALOG NUMBER	RATING		DESCRIPTION	CORD DIAMETER	NEMA CONFIG. NO.	3rd PARTY COMPLIANCE		
	A.	V.				UL498	FSUL WC596	CSA C22.2 No. 42
2 POLE, 3 WIRE GROUNDING								
43379	30	125	Angled Plug, Yellow		5-30P	•		
43399	50	125	Angled Plug, Yellow		5-50P	•		
3869	30/50	250	Angled Plug, Black	.56"-1.1"	6-30P/6-50P	•		
3 POLE, 3 WIRE NON-GROUNDING								
3861	30/50	125/250	Angled Plug, Black	.56"-1.1"	10-30P/10-50P	•		•
9977	20	125/250	Plug, Nylon		10-20P	•		
7088	20	125/250	Connector, Armored		10-20R			
3 POLE, 4 WIRE GROUNDING								
5746AN	30	125/250	Angled Plug, Yellow		14-30P	•		•
5741AN	30	3ø, 250	Angled Plug, Yellow		15-30P	•		•
5745AN	50	125/250	Angled Plug, Yellow		14-50P	•		•
14629	60	125/250	Angled Plug, Yellow		14-60P	•		•
5751AN	50	3ø, 250	Angled Plug, Yellow		15-50P	•		•
5761AN	60	3ø, 250	Angled Plug, Yellow		15-60P	•		•
3867	30/50	125/250	Angled Plug, Black	.56"-1.1"	14-30P/14-50P	•		•
4 POLE, 4 WIRE NON-GROUNDING								
7251DF	20	3øY, 120/208	Plug, Yellow	.365"-.775"	18-20P	•	•	
8302AN	60	3øY, 120/208	Angled Plug, Yellow		18-60P	•		

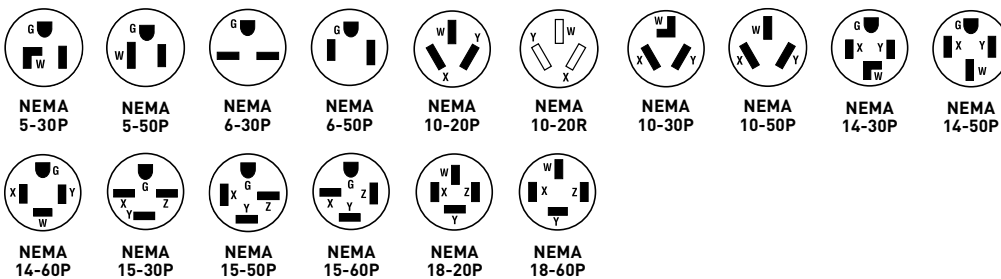

All devices listed on this page conform to NEMA WD-1 and WD-6.

STRAIGHT BLADE PLUGS & CONNECTORS

Gator Grip Devices

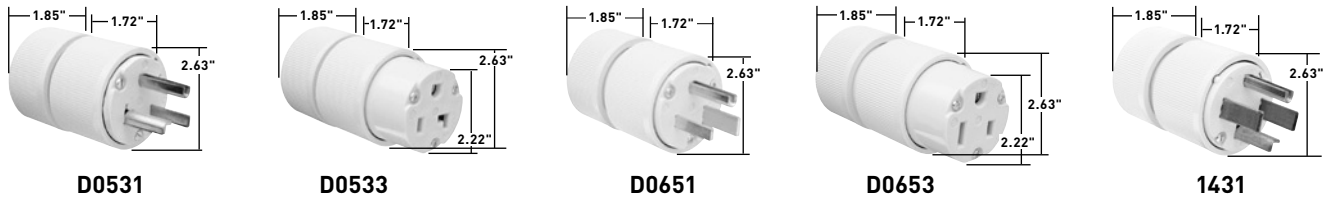

Features – Gator Grip Devices

- Gator Grip Jaws grab cord tighter as you hand turn the housing.
- Nylon jaws grip securely, but won't damage insulation.
- Self-locking Dardelet Thread holds securely and assures firm clamping.
- Fast wiring — simply insert stranded conductors into individual wiring chambers and tighten oversized terminal screws.
- Transparent wiring chamber cover allows visual inspection of wiring chambers to assure proper connections.
- Sloped shoulders won't catch or snap.
- Automatic cord centering.
- Brilliant high-visibility yellow.
- Neoprene Dust Seal helps keep out dirt and debris.
- Dead front construction.

CATALOG NUMBER	RATING		DESCRIPTION	CORD DIAMETER	NEMA CONFIG. NO.	3rd PARTY COMPLIANCE	
	A.	V.				UL498	FSUL WC596
2 POLE, 3 WIRE GROUNDING 30 & 50A, 125, 250 & 277V							
D0531	30	125	Plug, Yellow	.57"-1.26"	5-30P	•	•
D0533	30	125	Connector, Yellow	.57"-1.26"	5-30R	•	•
D0551	50	125	Plug, Yellow	.57"-1.26"	5-50P	•	•
D0553	50	125	Connector, Yellow	.57"-1.26"	5-50R	•	•
D0631	30	250	Plug, Yellow	.57"-1.26"	6-30P	•	•
D0633	30	250	Connector, Yellow	.57"-1.26"	6-30R	•	•
D0651	50	250	Plug, Yellow	.57"-1.26"	6-50P	•	•
D0653	50	250	Connector, Yellow	.57"-1.26"	6-50R	•	•
D0731	30	277	Plug, Yellow	.57"-1.26"	7-30P	•	•
D0751	50	277	Plug, Yellow	.57"-1.26"	7-50P	•	•
3 POLE, 3 WIRE 30 & 50A, 125/250V							
1031	30	125/250	Plug, Yellow	.57"-1.26"	10-30P	•	•
1033	30	125/250	Connector, Yellow	.57"-1.26"	10-30R	•	•
1051	50	125/250	Plug, Yellow	.57"-1.26"	10-50P	•	•
1053	50	125/250	Connector, Yellow	.57"-1.26"	10-50R	•	•
3 POLE, 4 WIRE 30 & 50A, 125/250V							
1431	30	125/250	Plug, Yellow	.57"-1.26"	14-30P	•	•
1451	50	125/250	Plug, Yellow	.57"-1.26"	14-50P	•	•
4 POLE, 4 WIRE 60A, 3ØY 120/208V							
D1861	60	3ØY, 120/208	Plug, Yellow	.57"-1.26"	18-60P	•	•

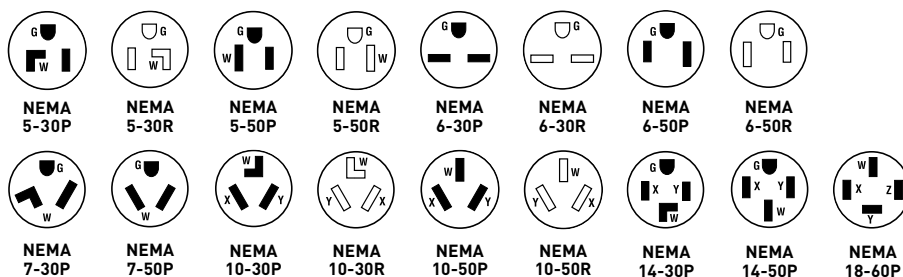

STRAIGHT BLADE PLUGS & CONNECTORS

STRAIGHT BLADE PLUGS & CONNECTORS

Clamp-Lock™ Devices 2 Pole, 3 Wire Grounding 15A, 125V; 20A, 125V

PS515CCLB

Clamp-Lock™ Straight Blade Plugs & Connectors

- A. Self-centering cord grip** helps speed assembly.
- B. Removable inserts** accommodate the widest possible range of cable diameters.
- C. Rugged nylon housing and backbody withstand** chemicals, heat, wear and impact.
- D. Color-coded levers** enable terminal identification at a glance and reduce the chance of wiring errors.
- E. Speedy, patented cam-lever termination** provides solid, dependable connections.
- F. Molded-in guide** shows correct wire stripping length.
- G. Solid brass blades and contacts** provide excellent conductivity.
- H. Transparent polycarbonate terminal cover** makes terminals visible for visual termination verification.

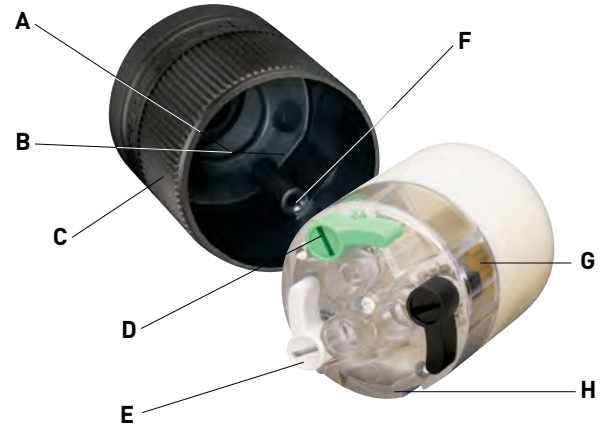

U-drive combination slot/crosshead screws ensure easy assembly.

Long, deep channels guide conductors and prevent over-insertion.

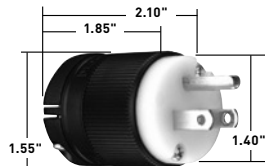

PS515PCLB



PS515CCLB

CATALOG NUMBER	RATING		DESCRIPTION	CORD DIAMETER	NEMA CONFIG. NO.	3rd PARTY COMPLIANCE	
	A.	V.				cULus	FSUL WC596
P&S CLAMP-LOCK™ STRAIGHT BLADE PLUGS & CONNECTORS							
PS515PCLBCCV4	15	125	Plug, Black & White	.20"-.470"	5-15P	•	•
PS515CCLBCCV4	15	125	Connector, Black & White	.20"-.470"	5-15R	•	•
PS520PCLBCCV4	20	125	Plug, Black & White	.20"-.470"	5-20P	•	•
PS520CCLBCCV4	20	125	Connector, Black & White	.20"-.470"	5-20R	•	•



NEMA 5-15P



NEMA 5-15R



NEMA 5-20P



NEMA 5-20R

STRAIGHT BLADE PLUGS & CONNECTORS

Product Specifications & Performance

EHU & Corrosion-Resistant Plugs & Connectors 15 & 20A Straight Blade

Plugs	
Back Body	Nylon
Front Body	Nylon
Terminal Chamber	Polycarbonate
Cord Clamp	Nylon
Insert	Nylon
Blades	Brass*
Terminal Clamp	Zinc-Plated Steel*
Terminal Screws	Nickel- or Brass-Plated Steel
Ground Screws	Nickel-Plated Steel
Cord Clamp Screws	Nickel-Plated Steel #8
Assembly Screws	Nickel-Plated Steel

Connectors	
Back Body	Nylon
Front Body	Nylon
Terminal Chamber	Polycarbonate
Cord Clamp	Nylon
Insert	Nylon
Contacts	Brass*
Terminal Clamp	Zinc-Plated Steel*
Terminal Screws	Nickel- or Brass-Plated Steel
Ground Screws	Nickel-Plated Steel
Cord Clamp Screws	Nickel-Plated Steel #8
Assembly Screws	Nickel-Plated Steel

Performance	
Electrical	
Dielectric Withstand Voltage	1500V minimum
Maximum Working Voltage	250V
Current Interrupting	Certified for current interrupting at full-rated current
Temperature Rise	30°C maximum after 50 cycles at 150% rated current
Mechanical	
Cord Accommodation	Round portable service cords of diameters in accordance with the device rating as defined in UL62
Cord Grip Accommodation	.230"-.720" diameter
Terminal Identification	Green = Ground, White = Neutral, Brass = Hot
Terminal Accommodation	#18 AWG min.- #10 AWG max.
Product Identification	Amperage, Voltage, 3rd Party Compliance, NEMA configuration
Environmental	
Flammability	UL94 V2
Operating Temperature	Maximum continuous: +75°C Minimum: -40°C without impact

*Nickel-Plated for Corrosion-Resistant Product.

EHU Ground Continuity Monitoring (GCM) Plugs & Connectors 15 & 20A Straight Blade

Plugs	
Back Body	Nylon
Front Body	Nylon
Terminal Chamber	Polycarbonate
Cord Clamp	Nylon
Insert	Nylon
Blades	Brass
Terminal Clamp	Zinc-Plated Steel
Terminal Screws	Nickel- or Brass-Plated Steel
Ground Screws	Nickel-Plated Steel
Cord Clamp Screws	Nickel-Plated Steel #8
Assembly Screws	Nickel-Plated Steel

Connectors	
Back Body	Nylon
Front Body	Nylon
Terminal Chamber	Polycarbonate
Cord Clamp	Nylon
Insert	Nylon
Contacts	Brass
Terminal Clamp	Zinc-Plated Steel
Terminal Screws	Nickel- or Brass-Plated Steel
Ground Screws	Nickel-Plated Steel
Cord Clamp Screws	Nickel-Plated Steel #8
Assembly Screws	Nickel-Plated Steel

Performance	
Electrical	
Dielectric Withstand Voltage	1500V minimum
Maximum Working Voltage	250V
Current Interrupting	Certified for current interrupting at full-rated current
Temperature Rise	30°C maximum after 50 cycles at 150% rated current
Mechanical	
Cord Accommodation	Round portable service cords of diameters in accordance with the device rating as defined in UL62
Cord Grip Accommodation	.230"-.720" diameter
Terminal Identification	Green = Ground, White = Neutral, Brass = Hot
Terminal Accommodation	#18 AWG min.- #10 AWG max.
Product Identification	Amperage, Voltage, 3rd Party Compliance, NEMA Configuration
Environmental	
Flammability	UL94 V2
Operating Temperature	Maximum continuous: +75°C Minimum: -40°C without impact

STRAIGHT BLADE PLUGS & CONNECTORS

Product Specifications & Performance

Gator Grip Devices Plugs & Connectors

30, 50 & 60A Straight Blade

Plugs

Back Body	Glass-Filled Polypropylene
Front Body	Glass-Filled Polypropylene
Terminal Chamber	Polycarbonate
Cord Clamp	Glass-Filled Nylon
Insert	Nylon
Blades	Brass
Terminal Clamp	Zinc-Plated Steel
Terminal Screws	Tin- or Brass-Plated Steel
Ground Screws	Zinc-Plated Steel
Cord Clamp Screws	N/A
Assembly Screws	Zinc-Plated Steel

Connectors

Back Body	Glass-Filled Polypropylene
Front Body	Glass-Filled Polypropylene
Terminal Chamber	Polycarbonate
Cord Clamp	Glass-Filled Polypropylene
Insert	Nylon
Contacts	Brass
Terminal Clamp	Zinc-Plated Steel
Terminal Screws	Tin- or Brass-Plated Steel
Ground Screws	Zinc-Plated Steel
Cord Clamp Screws	N/A
Assembly Screws	Zinc-Plated Steel

Performance

Electrical

Dielectric Withstand Voltage	1500V
Maximum Working Voltage	Up to 277V
Current Interrupting	Certified for current interrupting at full-rated current
Temperature Rise	30°C maximum after 50 cycles at 150% rated current

Mechanical

Cord Accommodation	Round portable service cords of diameters in accordance with the device rating as defined in UL62
Cord Grip Accommodation	.570"–1.260" diameter
Terminal Identification	Green = Ground, White = Neutral, Brass = Hot
Terminal Accommodation	#10 AWG min.– #4 AWG max.
Product Identification	Amperage, Voltage, 3rd Party Compliance, NEMA Configuration

Environmental

Flammability	UL94 V0
Operating Temperature	Maximum continuous: +75°C Minimum: -40°C without impact

MaxGrip® M³ Plugs & Connectors

Plugs

Part	Material
Body/Housing	Nylon
Cord Grip Insert	Nylon
Terminal Clamp	Brass
Terminal Screws	Zinc- or Brass-Plated Steel
Ground Screws	Zinc-Plated Steel
Blades	Brass
Cord Clamp Assembly Screws	Zinc-Plated Steel

Connectors

Part	Material
Body/Housing	Nylon
Cord Grip Insert	Nylon
Terminal Clamp	Brass
Terminal Screws	Zinc- or Brass-Plated Steel
Ground Screws	Zinc-Plated Steel
Contacts	Brass
Cord Clamp Assembly Screws	Zinc-Plated Steel

Performance

Electrical

Dielectric Withstand Voltage	1500V
Maximum Working Voltage	250V
Current Interrupting	Certified for current interrupting at full-rated current
Temperature Rise	30°C maximum after 50 cycles at 150% rated current

Mechanical

Cord Accommodation	Round portable service cords of diameters in accordance with the device rating as defined in UL62
Cord Grip Accommodation	.230"–.720" diameter cord
Terminal Identification	Green = Ground, Silver = Neutral, Brass = Hot
Terminal Accommodation	#18 AWG min.– #12 AWG max.
Product Identification	Amperage, Voltage, 3rd Party Compliance, NEMA Configuration

Environmental

Flammability	UL94 HB
Operating Temperature	Maximum continuous: +75°C; Minimum: -40°C without impact

STRAIGHT BLADE PLUGS & CONNECTORS

Product Specifications & Performance

Clamp-Lock™ Plugs & Connectors

Plugs

Part	Material
Body/Housing	Nylon
Cord Grip Insert	Nylon
Terminal Clamp	Brass
Terminal Screws	Zinc- or Brass-Plated Steel
Ground Screws	Zinc-Plated Steel
Blades	Brass
Cord Clamp Assembly Screws	Zinc-Plated Steel

Connectors

Part	Material
Body/Housing	Nylon
Cord Grip Insert	Nylon
Terminal Clamp	Brass
Terminal Screws	Zinc- or Brass-Plated Steel
Ground Screws	Zinc-Plated Steel
Contacts	Brass
Cord Clamp Assembly Screws	Zinc-Plated Steel

Performance

Electrical

Dielectric Withstand Voltage	1500V
Maximum Working Voltage	250V
Current Interrupting	Certified for current interrupting at full-rated current
Temperature Rise	30°C maximum after 50 cycles at 150% rated current

Mechanical

Cord Accommodation	Round portable service cords of diameters in accordance with the device rating as defined in UL62
Cord Grip Accommodation	.20"-.470" diameter cord
Terminal Identification	Green = Ground, Silver = Neutral, Brass = Hot
Terminal Accommodation	#18 AWG min.- #12 AWG max.
Product Identification	Amperage, Voltage, 3rd Party Compliance, NEMA Configuration

Environmental

Flammability	UL94 HB
Operating Temperature	Maximum continuous: +75°C; Minimum: -40°C without impact

Straight Blade Horsepower Rating for NEMA Configuration Attachment Plugs & Receptacles

NEMA Configuration	AC HP Rating
5-15	½
6-15	1½*
7-15	2
5-20	1
6-20	2*
7-20	2
10-20	2 Line to Line* 1 Line to Neutral

*Suitable for 208V motor applications at the HP rating specified.

INDUSTRIAL SPEC GRADE TURNLOK® LOCKING DEVICES



Featured Products	 <p>20 AMP TURNLOK DEVICES</p> <p>H-9</p>	 <p>30 AMP TURNLOK DEVICES</p> <p>H-16</p>	 <p>GCM PLUGS & CONNECTORS</p> <p>H-24</p>
-------------------	---	---	--

NEMA Configurations	H-3	Non-NEMA	H-26
Midget Connectors, Plugs, Inlets, Outlets	H-4	20 Amp Non-NEMA	H-27
15 & 20 Amp NEMA	H-5	30 Amp Non-NEMA	H-28
15 Amp NEMA	H-6	Power Interrupting Devices	H-29
Angle Plugs & Adapters	H-8	California Standard & Corrosion-Resistant	H-32
20 Amp NEMA	H-9	Accessories	H-34
30 Amp NEMA	H-16	Common Marine Applications	H-36
Heavy-Duty Ground Continuity Monitoring (GCM) Plugs & Connectors	H-24	Product Specifications & Performance, Horsepower Ratings	H-37

INDUSTRIAL SPEC GRADE TURNLOK® LOCKING DEVICES

L630C & L630P Connector & Plug

- A. Raised ribs** provide non-slip gripping profile for turning to lock and unlock.
- B. Quick-thread assembly screws** and cord-grip screws come backed-out, ready-to-wire.
- C. Industrial-strength, brass alloy plug blades**, and connector contacts resist heat rise, provide excellent conductivity.
- D. Rounded back contour** reduces snags and hang-ups on the job site.
- E. Impact- and corrosion-resistant heavy-duty nylon shell** material resistant to impacts and abuse.
- F. Integral flexible rubber cord grommet** conforms to and seals around SO cord to provide protection from oils, water, or chips entering wiring chamber.
- G. New-design external cord grips** provide visible assurance of safe and proper cord retention and a wide range of OD acceptance.
- H. Scallop shell design** provides non-slip gripping surface for insertion and withdrawal.
- I. Double dovetail design** provides superior protection against cord pull-out forces.
- J. Visible stamped NEMA configuration and device rating.**

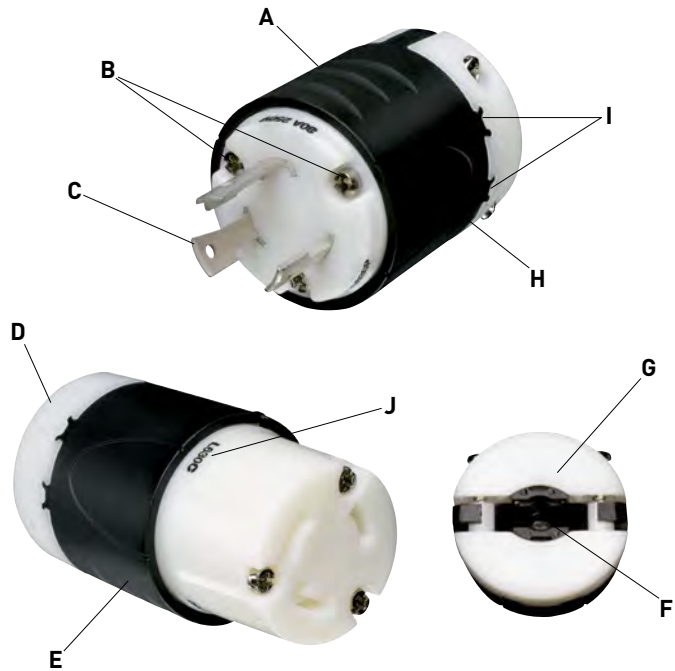

L630R Receptacles

- A. Compact, impact-resistant nylon face and body** are ultrasonically welded together for unrivaled strength.
- B. Clearly marked NEMA configuration, rating, and third party listing** on each unit's face.
- C. One-piece, high-grade brass contacts** offer excellent conductivity and heat-rise resistance.
- D. Single-piece, solid brass mounting strap** is free of easily loosened rivets found on other brands.
- E. Side and external screw-pressure-plate back wire capability.** Accepts #14 - #10 AWG.

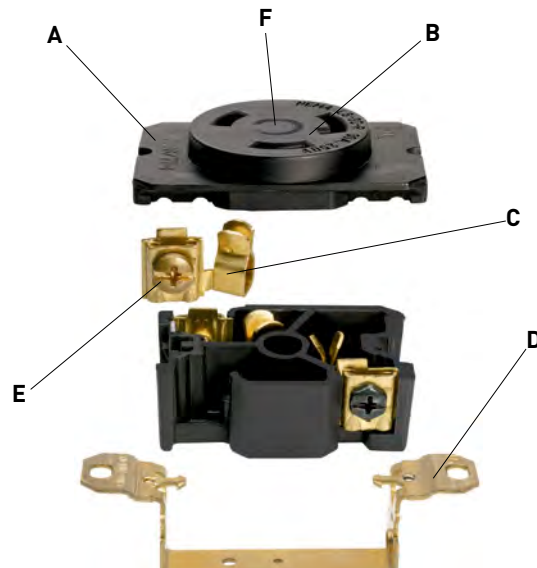

F. P&S Turnlok Receptacles. Voltage color coding on the outside. Proven designs and quality materials on the inside. Any way you look at them, they're the standard of the industry.



INDUSTRIAL SPEC GRADE TURNLOK® LOCKING DEVICES

NEMA Configurations

Locking Plugs & Receptacles

	15 AMPERE		20 AMPERE		30 AMPERE	
	RECEPTACLE	PLUG	RECEPTACLE	PLUG	RECEPTACLE	PLUG
2 POLE, 2 WIRE NON-GROUNDING						
125V	L1					
	L2					
250V						
2 POLE, 3 WIRE GROUNDING						
125V	L5					
	L6					
250V						
277VAC	L7					
	L24					
347VAC						
480VAC	L8					
	L9					
600VAC						
3 POLE, 3 WIRE NON-GROUNDING						
125/250V	L10					
3ø250V	L11					
3ø480V	L12					
3ø600V	L13					
3 POLE, 4 WIRE GROUNDING						
125/250V	L14					
3ø250V	L15					
3ø480V	L16					
3ø600V	L17					
4 POLE, 4 WIRE NON-GROUNDING						
3øY 120/208V	L18					
3øY 277/480V	L19					
3øY 347/600V	L20					
4 POLE, 5 WIRE GROUNDING						
3øY 120/208V	L21					
3øY 277/480V	L22					
3øY 347/600V	L23					

Midget – Locking

	15 AMPERE	
	RECEPTACLE	PLUG
2 POLE, 2 WIRE NON-GROUNDING		
125V	ML1	ML1-1P
2 POLE, 3 WIRE GROUNDING		
125V	ML2	ML2-2P
3 POLE, 3 WIRE NON-GROUNDING		
125/250V	ML3	ML3-3P

Labels & Their Meaning

X, Y, Z	Hot Lead
W	Neutral Lead
G	Grounding Lead

Open Slots

Indicate receptacle configurations (female).

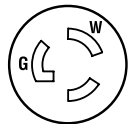

Closed Slots

Indicate plug blade configurations (male).



INDUSTRIAL SPEC GRADE TURNLOK® LOCKING DEVICES

Midget Connectors, Plugs, Inlets, Outlets 2 Pole, 2 Wire Non-Grounding 15A, 125V 2 Pole, 3 Wire Grounding 15A, 125V 3 Pole, 3 Wire Non-Grounding 15A, 125/250V

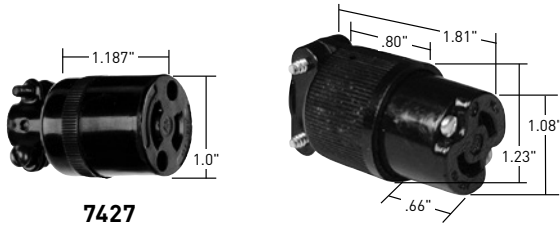

7427

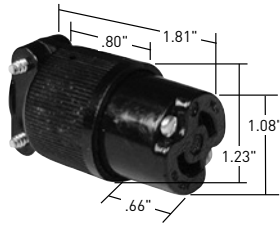

ML1133

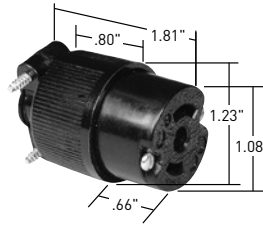

ML2133

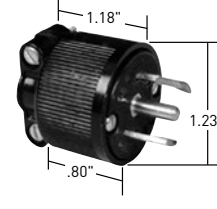

ML3113

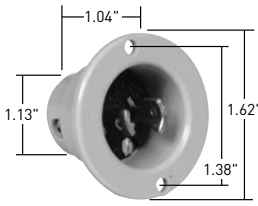

ML115

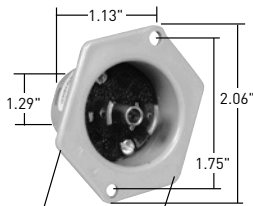

ML215

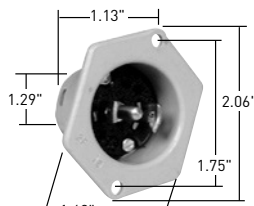

ML315

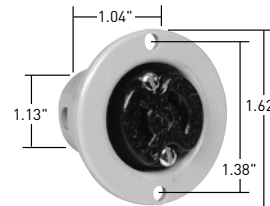

ML114

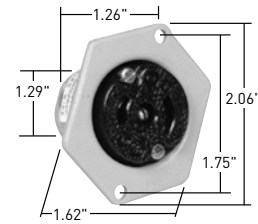

ML214

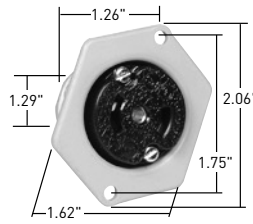

ML314

CATALOG NUMBER	RATING		DESCRIPTION	CORD DIAMETER	NEMA CONFIG. NO.	3rd PARTY COMPLIANCE
	A.	V.				UL498
CONNECTORS						
7427	15	125	Black	.312"-.50"	ML1-15R	•
ML1133	15	125	Black	.10"-.35"	ML1-15R	•
ML2133	15	125	Black	.18"-.52"	ML2-15R	•
ML3133	15	125/250	Black	.18"-.52"	ML3-15R	•
PLUGS						
ML1113	15	125	Black	.10"-.35"	ML1-15P	•
ML2113	15	125	Black	.18"-.52"	ML2-15P	•
ML3113	15	125/250	Black	.18"-.52"	ML3-15P	•
FLANGED INLETS & OUTLETS						
ML115	15	125	Inlet, Black Face, Gray Flange		ML1-15P	•
ML114	15	125	Outlet, Black Face, Gray Flange		ML1-15R	•
ML215	15	125	Inlet, Black Face, Gray Flange		ML2-15P	•
ML214	15	125	Outlet, Black Face, Gray Flange		ML2-15R	•
ML315	15	125/250	Inlet, Black Face, Gray Flange		ML3-15P	•
ML314	15	125/250	Outlet, Black Face, Gray Flange		ML3-15R	•

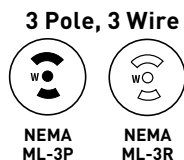
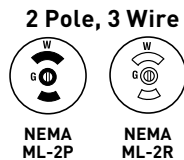
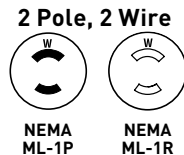

INDUSTRIAL SPEC GRADE TURNLOK® LOCKING DEVICES

15 & 20 Amp NEMA L115 & L220 2 Pole, 2 Wire Non-Grounding 15A, 125V & 20A, 250V

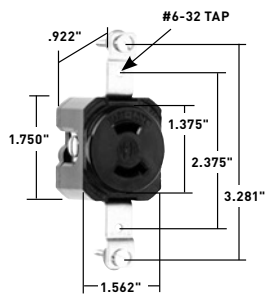

7535

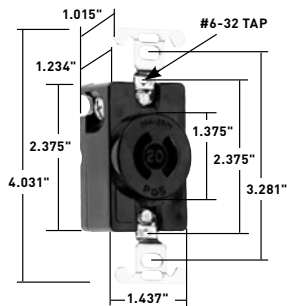

7210



7506

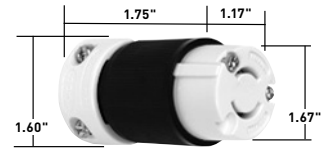

7101

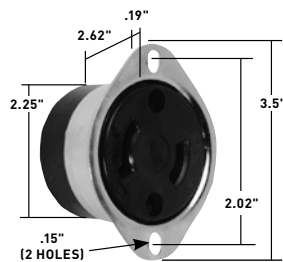

7526

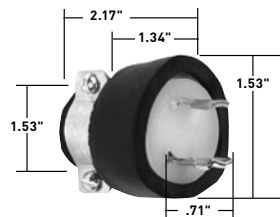

7547DF

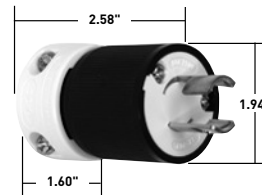

7102

CATALOG NUMBER	RATING		DESCRIPTION/COLOR	CORD DIAMETER	NEMA CONFIG. NO.	3rd PARTY COMPLIANCE
	A.	V.				UL498
RECEPTACLES						
7535	15	125	Single Receptacle		L1-15R	•
7210	20	250	Single Receptacle		L2-20R	•
CONNECTORS						
7506*	15	125	Black	.296"-.562"	L1-15R	•
7101*	20	250	Black Back, White Front Body	.296"-.562"	L2-20R	•
PLUGS						
7547DF	15	125	Black	.296"-.625"	L1-15P	•
7102*	20	250	Black Back, White Front Body	.296"-.562"	L2-20P	•
FLANGED INLETS & OUTLETS						
L0115	15	125	Inlet		L1-15P	•
7526	15	125	Outlet		L1-15R	•

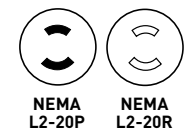
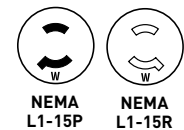

*For replacement use only.
Reference Pages H-34 and H-35 for Accessories.

INDUSTRIAL SPEC GRADE TURNLOK® LOCKING DEVICES

15 Amp NEMA L515 2 Pole, 3 Wire 15A, 125V

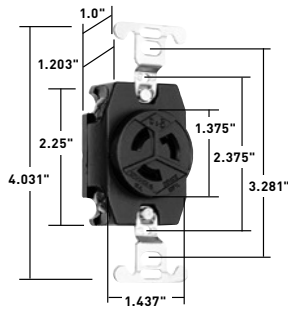

4710

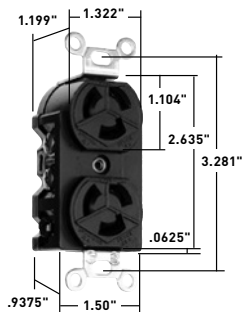

4700

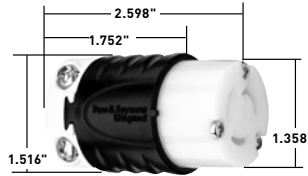

15A Connector

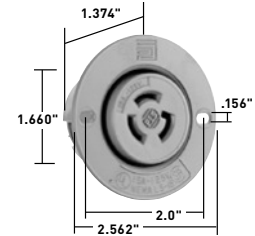

4715SS

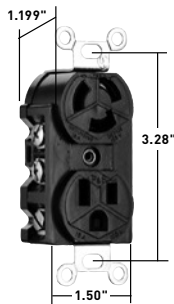

4792

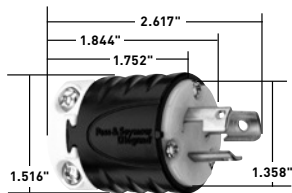

15A Plug

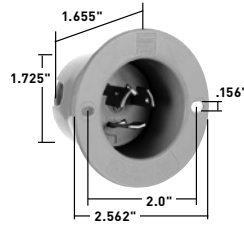

4716SS

INDUSTRIAL SPEC GRADE TURNLOK® LOCKING DEVICES

CATALOG NUMBER	RATING		DESCRIPTION/COLOR	CORD DIAMETER	NEMA CONFIG. NO.	3rd PARTY COMPLIANCE		
	A.	V.				UL498	FSUL WC596	CSA
RECEPTACLES								
4710	15	125	Single Receptacle		L5-15R	•		•
IG4710	15	125	Single Receptacle, Orange, Isolated Ground		L5-15R	•		•
4700	15	125	Duplex Receptacle		L5-15R	•		•
IG4700	15	125	Duplex Receptacle, Orange, Isolated Ground		L5-15R	•		•
4792	15	125	Combination Straight Blade and Locking		5-15R and L5-15R	•		
CONNECTORS IP20 SUITABILITY								
PSL515C	15	125	Black Back, White Front Body	.230"-.720"	L5-15R	•	•	•
CRL515C	15	125	Yellow Back, White Front Body, Corrosion-Resistant	.230"-.720"	L5-15R	•	•	•
PLUGS IP20 SUITABILITY								
PSL515P	15	125	Black Back, White Front Body	.230"-.720"	L5-15P	•	•	•
CRL515P	15	125	Yellow Back, White Front Body, Corrosion-Resistant	.230"-.720"	L5-15P	•	•	•
FLANGED INLETS & OUTLETS								
4716SS	15	125	Gray Inlet		L5-15P	•		•
4715SS	15	125	Gray Outlet		L5-15R	•		•



NEMA L5-15P



NEMA L5-15R



NEMA 5-15R

Reference Pages H-34 and H-35 for Accessories.

INDUSTRIAL SPEC GRADE TURNLOK® LOCKING DEVICES

15 Amp NEMA L615 & L715 2 Pole, 3 Wire 15A, 250 & 277V

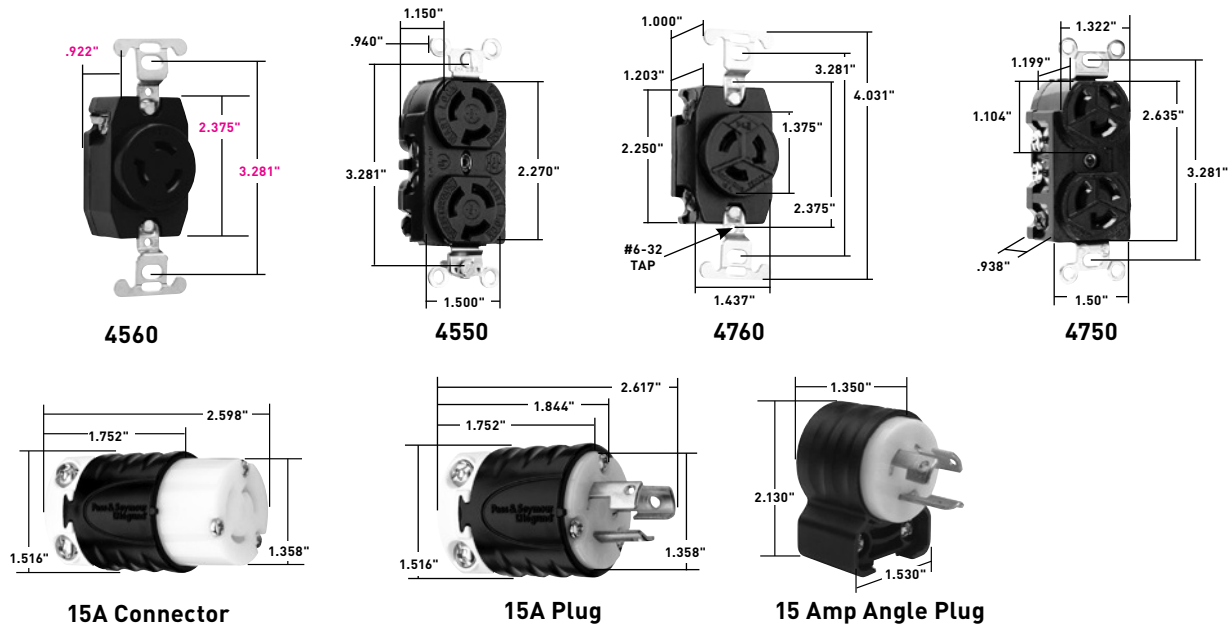

CATALOG NUMBER	RATING		DESCRIPTION/COLOR	CORD DIAMETER	NEMA CONFIG. NO.	3rd PARTY COMPLIANCE		
	A.	V.				UL498	FSUL WC596	CSA
RECEPTACLES								
4560	15	250	Single Receptacle		L6-15R	•		
4550*	15	250	Duplex Receptacle		L6-15R	•		
4760	15	277	Single Receptacle		L7-15R	•		•
IG4760	15	277	Single Receptacle, Orange, Isolated Ground		L7-15R	•		•
4750	15	277	Duplex Receptacle		L7-15R	•		•
CONNECTORS IP20 SUITABILITY								
PSL615C	15	250	Black Back, White Front Body	.230"-.720"	L6-15R	•	•	•
PSL715C	15	277	Black Back, White Front Body	.230"-.720"	L7-15R	•	•	•
PLUGS IP20 SUITABILITY								
PSL615P	15	250	Black Back, White Front Body	.230"-.720"	L6-15P	•	•	•
PSL615PAN	15	250	Angled Plug, Black Back, White Front Body	.320"-.655"	L6-15P	•		
PSL715P	15	277	Black Back, White Front Body	.230"-.720"	L7-15P	•	•	•
PSL715PAN	15	277	Angled Plug, Black Back, White Front Body	.320"-.655"	L7-15P	•		

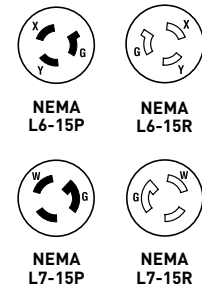

*Not designed for split circuits. Reference Pages H-34 and H-35 for Accessories.

INDUSTRIAL SPEC GRADE TURNLOK® LOCKING DEVICES

Angle Plugs & Adapters 2 Pole, 3 Wire 15A, 125, 250 & 277V; 3, 4 & 5 Wire 15, 20 & 30A Adapters

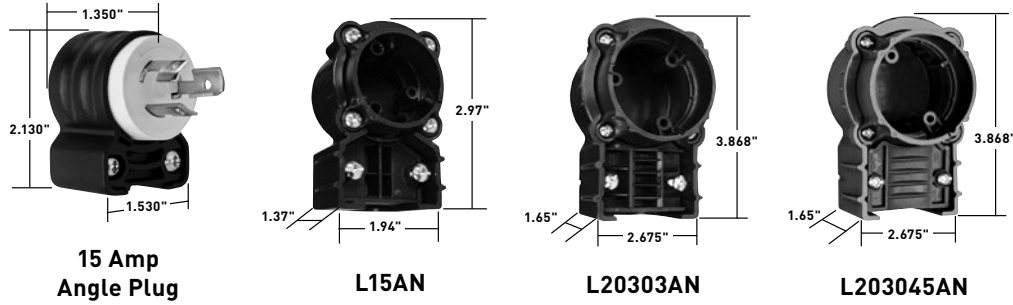

Features

- Angle plugs and adapters both allow for 4-position face rotation. 20/30A 3 Wire Turnlok® Right Angle Adapters are adjustable up to 8 positions.
- Angle adapters (sold separately) will accommodate all P&S Turnlok style plugs and connectors on a retrofit basis. Simply remove the straight handle body from the plug or connector face assembly, and replace with the angle adapter.
- Tri-drive assembly and cord-grip screws are standard on all angle plugs and adapters.
- Angle plugs and adapters have the same wide cord diameter range (.230"-1.150") that is present on all Turnlok plugs and connectors.

CATALOG NUMBER	RATING		DESCRIPTION	CORD DIAMETER	NEMA CONFIG. NO.	3rd PARTY COMPLIANCE	
	A.	V.				UL498	FSUL WC596
2 POLE, 3 WIRE GROUNDING							
PS4720SSAN	15	125	Black Back Body, White Front Body	.230"-.655"	L5-15P	•	•
PSL615PAN	15	250	Black Back Body, White Front Body	.230"-.690"	L6-15P	•	•
PSL715PAN	15	277	Black Back Body, White Front Body	.230"-.690"	L7-15P	•	•

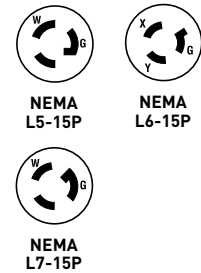

CATALOG NUMBER	DESCRIPTION	CORD DIAMETER
ACCESSORIES		
L15AN	15A Turnlok Right Angle Adapter	.230"-1.150"
L20303AN	20/30A 3 Wire Turnlok Right Angle Adapter	.230"-1.150"
L203045AN	20/30A 4 and 5 Wire Turnlok Right Angle Adapter	.230"-1.150"

INDUSTRIAL SPEC GRADE TURNLOK® LOCKING DEVICES

20 Amp NEMA L520 2 Pole, 3 Wire 20A, 125V

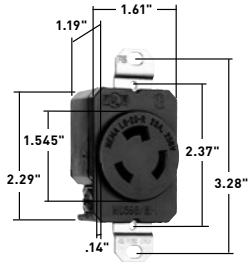

20A Receptacle

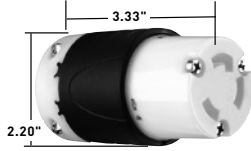

20A Connector

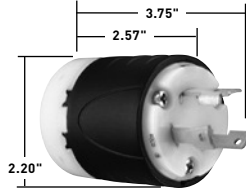

20A Plug

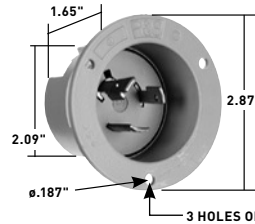

20A Flanged Inlet & Outlet

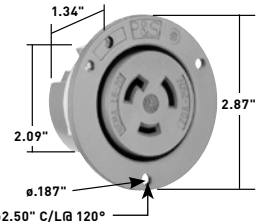

CATALOG NUMBER	RATING		DESCRIPTION/COLOR	CORD DIAMETER	NEMA CONFIG. NO.	3rd PARTY COMPLIANCE		
	A.	V.				UL498	FSUL WC596	CSA
RECEPTACLES								
L520R	20	125	Single Receptacle		L5-20R	•	•	•
IGL520R	20	125	Single Receptacle, Orange, Isolated Ground		L5-20R	•		•
CRL520R	20	125	Single Receptacle, Yellow, Corrosion-Resistant		L5-20R	•	•	•
L520RBL	20	125	Single Receptacle, Blue		L5-20R	•	•	•
L520RR	20	125	Single Receptacle, Red		L5-20R	•	•	•
CONNECTORS IP20 SUITABILITY								
L520C	20	125	Black Back, White Front Body	.225"-1.150"	L5-20R	•	•	•
L520CBK	20	125	Black Back, Black Front Body	.225"-1.150"	L5-20R	•	•	•
CRL520C	20	125	Yellow Back, White Front Body, Corrosion-Resistant	.225"-1.150"	L5-20R	•	•	•
PLUGS IP20 SUITABILITY								
L520P	20	125	Black Back, White Front Body	.225"-1.150"	L5-20P	•	•	•
L520PBK	20	125	Black Back, Black Front Body	.225"-1.150"	L5-20P	•	•	•
IGL520P	20	125	Black Back, Orange Front Body, Isolated Ground	.225"-1.150"	L5-20P	•		•
CRL520P	20	125	Yellow Back, White Front Body, Corrosion-Resistant	.225"-1.150"	L5-20P	•	•	•
FLANGED INLETS & OUTLETS								
L520FI	20	125	Gray Inlet		L5-20P	•		•
L520FO	20	125	Gray Outlet		L5-20R	•		•

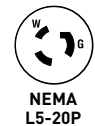

Reference Pages H-34 and H-35 for Accessories.

CATALOG NUMBER		COLOR
WEATHERPROOF COVER		
WPG2	Cover for 20 and 30A Turnlok Flanged Inlets and Outlets	Gray
STAINLESS STEEL WALL PLATE		
SS720	Wall Plate for Locking Receptacles	302/304
WEATHERPROOF BOOTS		
L2030RBC	Boot for 20/30A Locking Connector	Black
L2030RBP	Boot for 20/30A Locking Plug	Black
CORROSION-RESISTANT BOOTS		
CRL2030RBC	Boot for 20/30A Locking Connector	Yellow
CRL2030RBP	Boot for 20/30A Locking Plug	Yellow
RECEPTACLE COVERS		
7425Y	20/30A Receptacle Cover	Yellow
7425GRY	20/30A Receptacle Cover	Gray



SS720



7425GRY

All devices listed on this page conform to NEMA WD-1 and WD-6.

INDUSTRIAL SPEC GRADE TURNLOK® LOCKING DEVICES

20 Amp NEMA L620 & L720 2 Pole, 3 Wire 20A, 250 & 277V

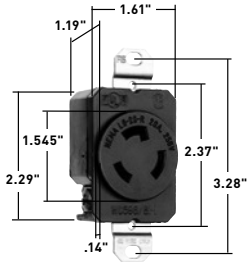

20A Receptacle

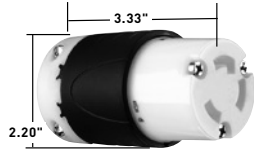

20A Connector

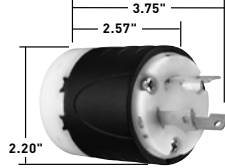

20A Plug

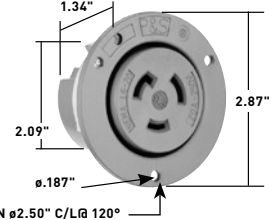
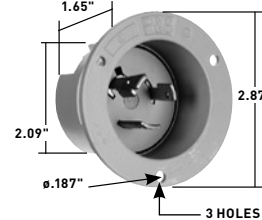

20A Flanged Inlet & Outlet

CATALOG NUMBER	RATING		DESCRIPTION/COLOR	CORD DIAMETER	NEMA CONFIG. NO.	3rd PARTY COMPLIANCE		
	A.	V.				UL498	FSUL WC596	CSA
RECEPTACLES								
L620R	20	250	Single Receptacle		L6-20R	•	•	•
L620RBL	20	250	Single Receptacle, Blue		L6-20R	•	•	•
L620RR	20	250	Single Receptacle, Red		L6-20R	•	•	•
IGL620R	20	250	Single Receptacle, Orange, Isolated Ground		L6-20R	•	•	•
L720R	20	277	Single Receptacle		L7-20R	•	•	•
IGL720R	20	277	Single Receptacle, Orange, Isolated Ground		L7-20R	•	•	•
CONNECTORS IP20 SUITABILITY								
L620C	20	250	Black Back, White Front Body	.225"-1.150"	L6-20R	•	•	•
L620CBK	20	250	Black Back, Black Front Body	.225"-1.150"	L6-20R	•	•	•
CRL620C	20	250	Yellow Back, White Front Body, Corrosion-Resistant	.225"-1.150"	L6-20R	•	•	•
L720C	20	277	Black Back, White Front Body	.225"-1.150"	L7-20R	•	•	•
PLUGS IP20 SUITABILITY								
L620P	20	250	Black Back, White Front Body	.225"-1.150"	L6-20P	•	•	•
L620PBK	20	250	Black Back, Black Front Body	.225"-1.150"	L6-20P	•	•	•
CRL620P	20	250	Yellow Back, White Front Body, Corrosion-Resistant	.225"-1.150"	L6-20P	•	•	•
L720P	20	277	Black Back, White Front Body	.225"-1.150"	L7-20P	•	•	•
FLANGED INLETS & OUTLETS								
L620FI	20	250	Gray Inlet		L6-20P	•	•	•
L620FO	20	250	Gray Outlet		L6-20R	•	•	•
L720FI	20	277	Gray Inlet		L7-20P	•	•	•
L720FO	20	277	Gray Outlet		L7-20R	•	•	•

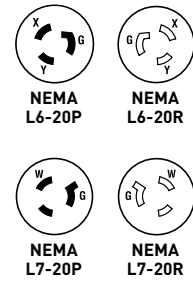

Reference Pages H-34 and H-35 for Accessories.

CATALOG NUMBER	DESCRIPTION	COLOR
WEATHERPROOF COVER		
WPG2	Cover for 20 and 30A Turnlok Flanged Inlets and Outlets	Gray
STAINLESS STEEL WALL PLATE		
SS720	Wall Plate for Locking Receptacles	302/304 S/S
RECEPTACLE COVERS		
7425Y	20/30 Amp Receptacle Cover	Yellow
7425GRY	20/30 Amp Receptacle Cover	Gray

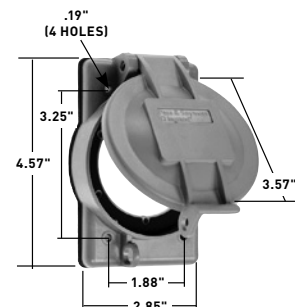

WPG2

INDUSTRIAL SPEC GRADE TURNLOK® LOCKING DEVICES

INDUSTRIAL SPEC GRADE TURNLOK® LOCKING DEVICES

20 Amp NEMA L820, L920 & L2420 2 Pole, 3 Wire 20A, 347, 480 & 600V

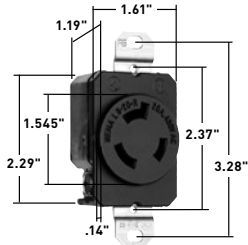

20A Receptacle

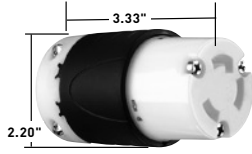

20A Connector

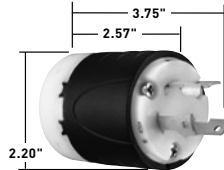

20A Plug

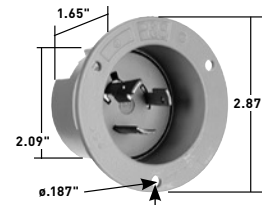

20A Flanged Inlet & Outlet

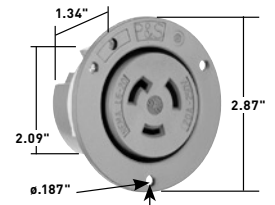

CATALOG NUMBER	RATING		DESCRIPTION/COLOR	CORD DIAMETER	NEMA CONFIG. NO.	3rd PARTY COMPLIANCE		
	A.	V.				UL498	FSUL WC596	CSA
RECEPTACLES								
L820R	20	480	Single Receptacle		L8-20R	•		•
IGL820R	20	480	Single Receptacle, Orange, Isolated Ground		L8-20R	•		•
L920R	20	600	Single Receptacle		L9-20R	•		•
L3720R	20	347	Single Receptacle		L24-20R			•
CONNECTORS IP20 SUITABILITY								
L820C	20	480	Black Back, White Front Body	.225"-1.150"	L8-20R	•		•
L920C	20	600	Black Back, White Front Body	.225"-1.150"	L9-20R	•		•
L3720C	20	347	Black Back, White Front Body	.225"-1.150"	L24-20R			•
PLUGS IP20 SUITABILITY								
L820P	20	480	Black Back, White Front Body	.225"-1.150"	L8-20P	•		•
L920P	20	600	Black Back, White Front Body	.225"-1.150"	L9-20P	•		•
L3720P	20	347	Black Back, White Front Body	.225"-1.150"	L24-20P	•	•	•
FLANGED INLETS & OUTLETS								
L820FI	20	480	Gray Inlet		L8-20P	•		•
L820FO	20	480	Gray Outlet		L8-20R	•		•
L920FI	20	600	Gray Inlet		L9-20P	•		•
L920FO	20	600	Gray Outlet		L9-20R	•		•
L3720FO	20	347	Gray Outlet		L24-20R			•

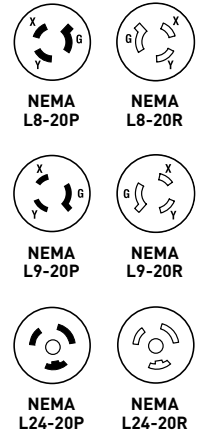

Reference Pages H-34 and H-35 for Accessories.

CATALOG NUMBER	DESCRIPTION	COLOR
WEATHERPROOF COVER		
WPG2	Cover for 20 and 30A Turnlok Flanged Inlets and Outlets	Gray
STAINLESS STEEL WALL PLATE		
SS720	Wall Plate for Locking Receptacles	302/304 S/S



SS720

INDUSTRIAL SPEC GRADE TURNLOK® LOCKING DEVICES

INDUSTRIAL SPEC GRADE TURNLOK® LOCKING DEVICES

20 Amp NEMA L1020, L1120 & L1220 3 Pole, 3 Wire Non-Grounding, 20A, 125/250V; 3ø, 250 & 480V

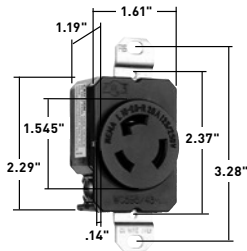

20A Receptacle

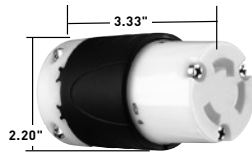

20A Connector

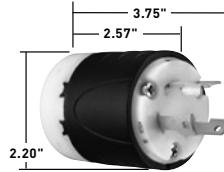

20A Plug

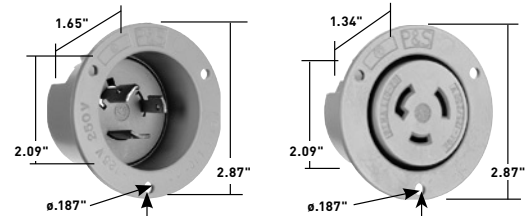

20A Flanged Inlet & Outlet

CATALOG NUMBER	RATING		DESCRIPTION/COLOR	CORD DIAMETER	NEMA CONFIG. NO.	3rd PARTY COMPLIANCE		
	A.	V.				UL498	FSUL WC596	CSA
RECEPTACLES								
L1020R	20	125/250	Single Receptacle		L10-20R	•	•	
L1120R	20	3ø, 250	Single Receptacle		L11-20R	•	•	
L1220R	20	3ø, 480	Single Receptacle		L12-20R	•	•	
CONNECTORS IP20 SUITABILITY								
L1020C	20	125/250	Black Back, White Front Body	.225"-1.150"	L10-20R	•	•	•
L1120C	20	3ø, 250	Black Back, White Front Body	.225"-1.150"	L11-20R	•	•	•
L1220C	20	3ø, 480	Black Back, White Front Body	.225"-1.150"	L12-20R	•	•	•
PLUGS IP20 SUITABILITY								
L1020P	20	125/250	Black Back, White Front Body	.225"-1.150"	L10-20P	•	•	•
L1120P	20	3ø, 250	Black Back, White Front Body	.225"-1.150"	L11-20P	•	•	•
L1220P	20	3ø, 480	Black Back, White Front Body	.225"-1.150"	L12-20P	•	•	•
FLANGED INLETS & OUTLETS								
L1020FI	20	125/250	Gray Inlet		L10-20P	•		•
L1020FO	20	125/250	Gray Outlet		L10-20R	•		
L1120FO	20	3ø, 250	Gray Outlet		L11-20R	•		
L1220FI	20	3ø, 480	Gray Inlet		L12-20P	•		•
L1220FO	20	3ø, 480	Gray Outlet		L12-20R	•		

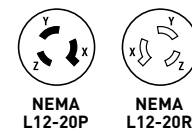
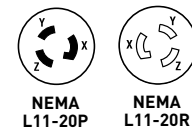
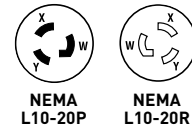

Reference Pages H-34 and H-35 for Accessories.

CATALOG NUMBER	DESCRIPTION	COLOR
WEATHERPROOF COVER		
WPG2	Cover for 20 and 30A Turnlok Flanged Inlets and Outlets	Gray
STAINLESS STEEL WALL PLATE		
SS720	Wall Plate for Locking Receptacles	302/304 S/S
WEATHERPROOF BOOTS		
L2030RBC	Boot for 20/30A Locking Connector	Black
L2030RBP	Boot for 20/30A Locking Plug	Black

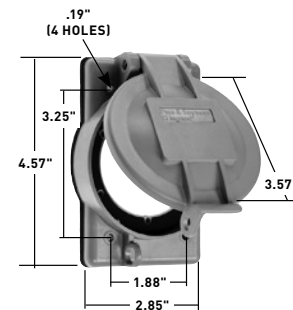

WPG2

INDUSTRIAL SPEC GRADE TURNLOK® LOCKING DEVICES

20 Amp NEMA L1420, L1520 & L1620 3 Pole, 4 Wire 20A, 125/250V; 3ø, 250 & 480V

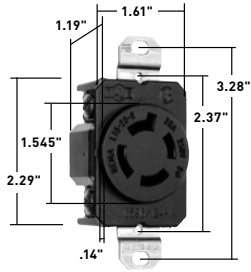

20A Receptacle



20A Connector

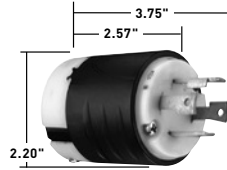

20A Plug

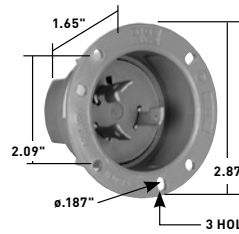

20A Flanged Inlet & Outlet

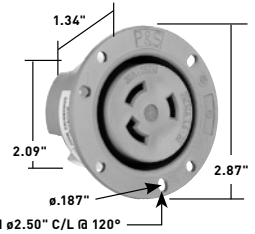

CATALOG NUMBER	RATING		DESCRIPTION/COLOR	CORD DIAMETER	NEMA CONFIG. NO.	3rd PARTY COMPLIANCE		
	A.	V.				UL498	FSUL WC596	CSA
RECEPTACLES								
L1420R	20	125/250	Single Receptacle		L14-20R	•	•	•
L1420RR	20	125/250	Single Receptacle, Red		L14-20R	•	•	•
IGL1420R	20	125/250	Single Receptacle, Orange, Isolated Ground		L14-20R	•		•
L1520R	20	3ø, 250	Single Receptacle		L15-20R	•	•	•
IGL1520R	20	3ø, 250	Single Receptacle, Orange, Isolated Ground		L15-20R	•		•
L1620R	20	3ø, 480	Single Receptacle		L16-20R	•	•	•
IGL1620R	20	3ø, 480	Single Receptacle, Orange, Isolated Ground		L16-20R	•		•
CONNECTORS IP20 SUITABILITY								
L1420C	20	125/250	Black Back, White Front Body	.225"-1.150"	L14-20R	•	•	•
CRL1420C	20	125/250	Yellow Back, White Front Body, Corrosion-Resistant	.225"-1.150"	L14-20R	•	•	•
L1520C	20	3ø, 250	Black Back, White Front Body	.225"-1.150"	L15-20R	•	•	•
L1520CBK	20	3ø, 250	Black Back, Black Front Body	.225"-1.150"	L15-20R	•	•	•
L1620C	20	3ø, 480	Black Back, White Front Body	.225"-1.150"	L16-20R	•	•	•
PLUGS IP20 SUITABILITY								
L1420P	20	125/250	Black Back, White Front Body	.225"-1.150"	L14-20P	•	•	•
CRL1420P	20	125/250	Yellow Back, White Front Body, Corrosion-Resistant	.225"-1.150"	L14-20P	•	•	•
L1520P	20	3ø, 250	Black Back, White Front Body	.225"-1.150"	L15-20P	•	•	•
L1520PBK	20	3ø, 250	Black Back, Black Front Body	.225"-1.150"	L15-20P	•	•	•
L1620P	20	3ø, 480	Black Back, White Front Body	.225"-1.150"	L16-20P	•	•	•
FLANGED INLETS & OUTLETS								
L1420FI	20	125/250	Gray Inlet		L14-20P	•		•
L1420FO	20	125/250	Gray Outlet		L14-20R	•		•
L1520FI	20	3ø, 250	Gray Inlet		L15-20P	•		•
L1520FO	20	3ø, 250	Gray Outlet		L15-20R	•		•
L1520FIBK	20	3ø, 250	Black Inlet		L15-20P	•		•
L1520FOBK	20	3ø, 250	Black Outlet		L15-20R	•		•
L1620FI	20	3ø, 480	Gray Inlet		L16-20P	•		•
L1620FO	20	3ø, 480	Gray Outlet		L16-20R	•		•

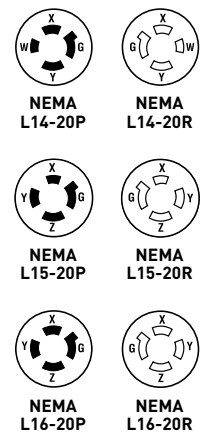

Reference Pages H-34 and H-35 for Accessories.

All devices listed on this page conform to NEMA WD-1 and WD-6.

INDUSTRIAL SPEC GRADE TURNLOK® LOCKING DEVICES

20 Amp NEMA L1820, L1920 & L2020

4 Pole, 4 Wire Non-Grounding 20A, 3ØY, 120/208, 277/480 & 347/600V

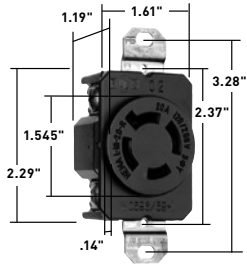

20A Receptacle



20A Connector

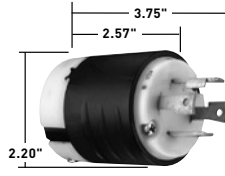

20A Plug

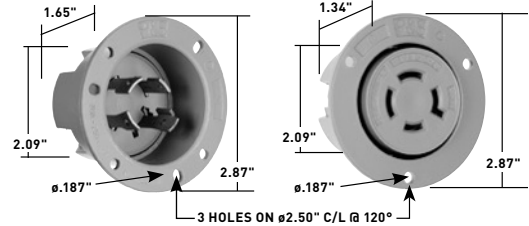

20A Flanged Inlet & Outlet

CATALOG NUMBER	RATING		DESCRIPTION/COLOR	CORD DIAMETER	NEMA CONFIG. NO.	3rd PARTY COMPLIANCE		
	A.	V.				UL498	FSUL WC596	CSA
RECEPTACLES								
L1820R	20	3ØY, 120/208	Single Receptacle		L18-20R	•	•	•
L1920R	20	3ØY, 277/480	Single Receptacle		L19-20R	•	•	•
L2020R	20	3ØY, 347/600	Single Receptacle		L20-20R	•	•	•
CONNECTORS IP20 SUITABILITY								
L1820C	20	3ØY, 120/208	Black Back, White Front Body	.225"-1.150"	L18-20R	•	•	•
L1920C	20	3ØY, 277/480	Black Back, White Front Body	.225"-1.150"	L19-20R	•	•	•
L2020C	20	3ØY, 347/600	Black Back, White Front Body	.225"-1.150"	L20-20R	•	•	•
PLUGS IP20 SUITABILITY								
L1820P	20	3ØY, 120/208	Black Back, White Front Body	.225"-1.150"	L18-20P	•	•	•
L1920P	20	3ØY, 277/480	Black Back, White Front Body	.225"-1.150"	L19-20P	•	•	•
L2020P	20	3ØY, 347/600	Black Back, White Front Body	.225"-1.150"	L20-20P	•	•	•
FLANGED INLETS & OUTLETS								
L1820FI	20	3ØY, 120/208	Gray Inlet		L18-20P	•	•	•
L1820FO	20	3ØY, 120/208	Gray Outlet		L18-20R	•	•	•
L1920FI	20	3ØY, 277/480	Gray Inlet		L19-20P	•	•	•
L1920FO	20	3ØY, 277/480	Gray Outlet		L19-20R	•	•	•
L2020FI	20	3ØY, 347/600	Gray Inlet		L20-20P	•	•	•
L2020FO	20	3ØY, 347/600	Gray Outlet		L20-20R	•	•	•

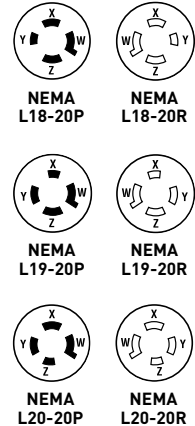

Reference Pages H-34 and H-35 for Accessories.

CATALOG NUMBER	DESCRIPTION	COLOR
WEATHERPROOF COVER		
WPG2	Cover for 20 and 30A Turnlok Flanged Inlets and Outlets	Gray
STAINLESS STEEL WALL PLATE		
SS720	Wall Plate for Locking Receptacles	302/304 S/S
RECEPTACLE COVERS		
7425Y	20/30A Receptacle Cover	Yellow
7425GRY	20/30A Receptacle Cover	Gray

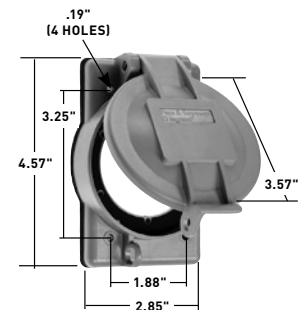

WPG2

INDUSTRIAL SPEC GRADE TURNLOK® LOCKING DEVICES

20 Amp NEMA L2120, L2220 & L2320 4 Pole, 5 Wire 20A, 3 ϕ Y, 120/208, 277/480 & 347/600V

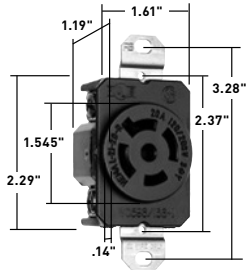

20A Receptacle



20A Connector

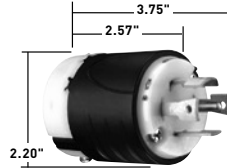

20A Plug

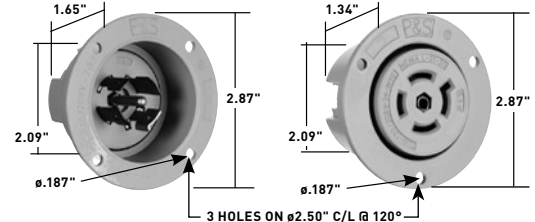

20A Flanged Inlet & Outlet

CATALOG NUMBER	RATING		DESCRIPTION/COLOR	CORD DIAMETER	NEMA CONFIG. NO.	3rd PARTY COMPLIANCE		
	A.	V.				UL498	FSUL WC596	CSA
RECEPTACLES								
L2120R	20	3 ϕ Y, 120/208	Single Receptacle		L21-20R	•	•	•
L2120RBL	20	3 ϕ Y, 120/208	Single Receptacle, Blue		L21-20R	•	•	•
IGL2120R	20	3 ϕ Y, 120/208	Single Receptacle, Orange, Isolated Ground		L21-20R	•		•
L2220R	20	3 ϕ Y, 277/480	Single Receptacle		L22-20R	•	•	•
IGL2220R	20	3 ϕ Y, 277/480	Single Receptacle, Orange, Isolated Ground		L22-20R	•		•
L2320R	20	3 ϕ Y, 347/600	Single Receptacle		L23-20R	•	•	•
IGL2320R	20	3 ϕ Y, 347/600	Single Receptacle, Orange, Isolated Ground		L23-20R	•		•
CONNECTORS IP20 SUITABILITY								
L2120C	20	3 ϕ Y, 120/208	Black Back, White Front Body	.225"-1.150"	L21-20R	•	•	•
L2120CBK	20	3 ϕ Y, 120/208	Black Back, Black Front Body	.225"-1.150"	L21-20R	•	•	•
L2220C	20	3 ϕ Y, 277/480	Black Back, White Front Body	.225"-1.150"	L22-20R	•	•	•
L2320C	20	3 ϕ Y, 347/600	Black Back, White Front Body	.225"-1.150"	L23-20R	•	•	•
PLUGS IP20 SUITABILITY								
L2120P	20	3 ϕ Y, 120/208	Black Back, White Front Body	.225"-1.150"	L21-20P	•	•	•
L2120PBK	20	3 ϕ Y, 120/208	Black Back, Black Front Body	.225"-1.150"	L21-20P	•	•	•
L2220P	20	3 ϕ Y, 277/480	Black Back, White Front Body	.225"-1.150"	L22-20P	•	•	•
L2320P	20	3 ϕ Y, 347/600	Black Back, White Front Body	.225"-1.150"	L23-20P	•	•	•
FLANGED INLETS & OUTLETS								
L2120FI	20	3 ϕ Y, 120/208	Gray Inlet		L21-20P	•		•
L2120FO	20	3 ϕ Y, 120/208	Gray Outlet		L21-20R	•		•
L2220FI	20	3 ϕ Y, 277/480	Gray Inlet		L22-20P	•		•
L2220FIBK	20	3 ϕ Y, 277/480	Black Inlet		L22-20P	•		•
L2220FO	20	3 ϕ Y, 277/480	Gray Outlet		L22-20R	•		•
L2220FOBK	20	3 ϕ Y, 277/480	Black Outlet		L22-20R	•		•
L2320FI	20	3 ϕ Y, 347/600	Gray Inlet		L23-20P	•		•
L2320FO	20	3 ϕ Y, 347/600	Gray Outlet		L23-20R	•		•

Reference Pages H-34 and H-35 for Accessories.

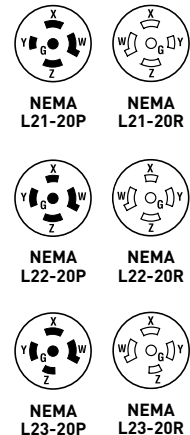

INDUSTRIAL SPEC GRADE TURNLOK® LOCKING DEVICES

INDUSTRIAL SPEC GRADE TURNLOK® LOCKING DEVICES

30 Amp NEMA L530 2 Pole, 3 Wire 30A, 125V

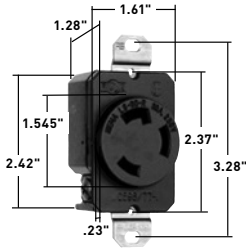

30A Receptacle

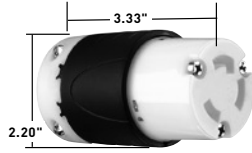

30A Connector

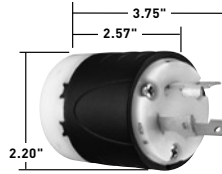

30A Plug

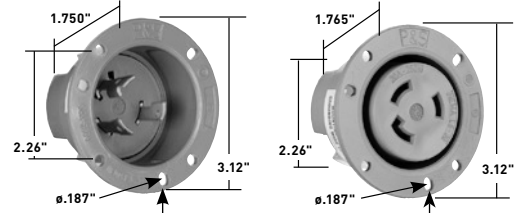

30A Flanged Inlet & Outlet

CATALOG NUMBER	RATING		DESCRIPTION/COLOR	CORD DIAMETER	NEMA CONFIG. NO.	3rd PARTY COMPLIANCE		
	A.	V.				UL498	FSUL WC596	CSA
RECEPTACLES								
L530R	30	125	Single Receptacle		L5-30R	•	•	•
L530RBL	30	125	Single Receptacle, Blue		L5-30R	•	•	•
L530RR	30	125	Single Receptacle, Red		L5-30R	•	•	•
IGL530R	30	125	Single Receptacle, Orange, Isolated Ground		L5-30R	•		•
CRL530R	30	125	Single Receptacle, Yellow Corrosion-Resistant		L5-30R	•	•	•
CONNECTORS IP20 SUITABILITY								
L530C	30	125	Black Back, White Front Body	.225"-1.150"	L5-30R	•	•	•
CRL530C	30	125	Yellow Back, White Front Body, Corrosion-Resistant	.225"-1.150"	L5-30R	•	•	•
PLUGS IP20 SUITABILITY								
L530P	30	125	Black Back, White Front Body	.225"-1.150"	L5-30P	•	•	•
CRL530P	30	125	Yellow Back, White Front Body, Corrosion-Resistant	.225"-1.150"	L5-30P	•	•	•
FLANGED INLETS & OUTLETS								
L530FI	30	125	Gray Inlet		L5-30P	•		•
L530FO	30	125	Gray Outlet		L5-30R	•		•

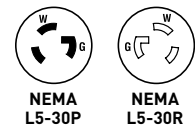

Reference Pages H-34 and H-35 for Accessories.

CATALOG NUMBER	DESCRIPTION	COLOR
WEATHERPROOF COVER		
WPG2	Cover for 20 and 30A Turnlok Flanged Inlets and Outlets	Gray
STAINLESS STEEL WALL PLATE		
SS720	Wall Plate for Locking Receptacles	302/304 S/S
RECEPTACLE COVERS		
7425Y	20/30 Amp Receptacle Cover	Yellow
7425GRY	20/30 Amp Receptacle Cover	Gray

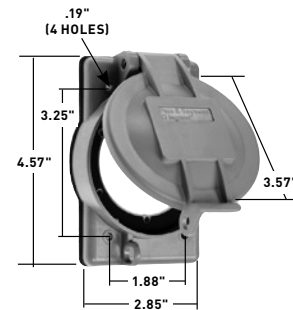

WPG2

INDUSTRIAL SPEC GRADE TURNLOK® LOCKING DEVICES

INDUSTRIAL SPEC GRADE TURNLOK® LOCKING DEVICES

30 Amp NEMA L630 & L730 2 Pole, 3 Wire 30A, 250 & 277V

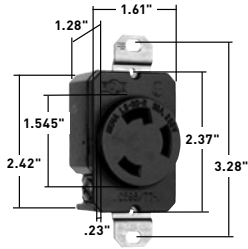

30A Receptacle

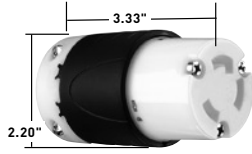

30A Connector

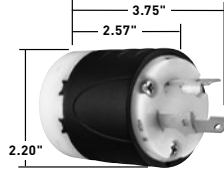

30A Plug

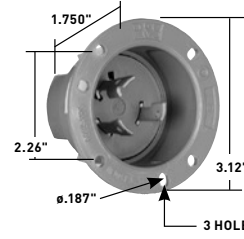

30A Flanged Inlet & Outlet

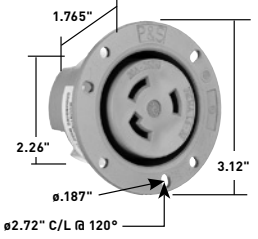

CATALOG NUMBER	RATING		DESCRIPTION/COLOR	CORD DIAMETER	NEMA CONFIG. NO.	3rd PARTY COMPLIANCE		
	A.	V.				UL498	FSUL WC596	CSA
RECEPTACLES								
L630R	30	250	Single Receptacle		L6-30R	•	•	•
L630RBL	30	250	Single Receptacle, Blue		L6-30R	•	•	•
L630RR	30	250	Single Receptacle, Red		L6-30R	•	•	•
IGL630R	30	250	Single Receptacle, Orange, Isolated Ground		L6-30R	•		•
L730R	30	277	Single Receptacle		L7-30R	•	•	•
CONNECTORS IP20 SUITABILITY								
L630C	30	250	Black Back, White Front Body	.225"-.750"	L6-30R	•	•	•
CRL630C	30	250	Yellow Back, White Front Body, Corrosion-Resistant	.225"-.750"	L6-30R	•	•	•
L730C	30	277	Black Back, White Front Body	.225"-.750"	L7-30R	•	•	•
PLUGS IP20 SUITABILITY								
L630P	30	250	Black Back, White Front Body	.225"-.750"	L6-30P	•	•	•
CRL630P	30	250	Yellow Back, White Front Body, Corrosion-Resistant	.225"-.750"	L6-30P	•	•	•
L730P	30	277	Black Back, White Front Body	.225"-.750"	L7-30P	•	•	•
FLANGED INLETS & OUTLETS								
L630FI	30	250	Gray Inlet		L6-30P	•		•
L630FO	30	250	Gray Outlet		L6-30R	•		•
L730FI	30	277	Gray Inlet		L7-30P	•		•
L730FO	30	277	Gray Outlet		L7-30R	•		•

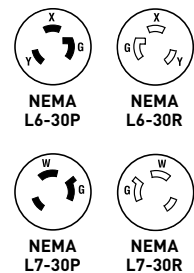

Reference Pages H-34 and H-35 for Accessories.

CATALOG NUMBER	DESCRIPTION	COLOR
WEATHERPROOF COVER		
WP62	Cover for 20 and 30A Turnlok Flanged Inlets and Outlets	Gray
STAINLESS STEEL WALL PLATE		
SS720	Wall Plate for Locking Receptacles	302/304 S/S

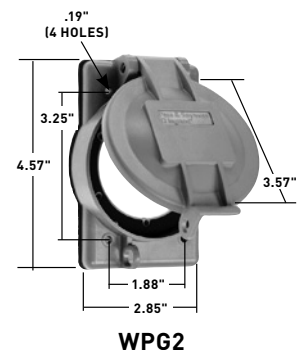

All devices listed on this page conform to NEMA WD-1 and WD-6.

INDUSTRIAL SPEC GRADE TURNLOK® LOCKING DEVICES

30 Amp NEMA L830 & L930 2 Pole, 3 Wire 30A, 480 & 600V

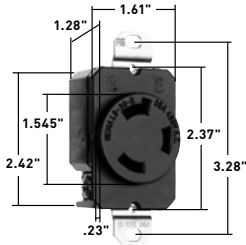

30A Receptacle

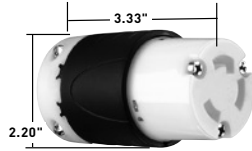

30A Connector

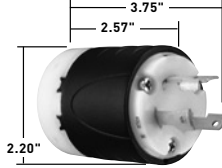

30A Plug

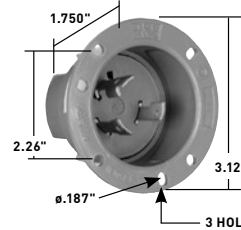

30A Flanged Inlet & Outlet

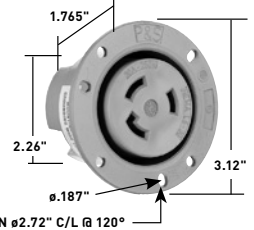

CATALOG NUMBER	RATING		DESCRIPTION/COLOR	CORD DIAMETER	NEMA CONFIG. NO.	3rd PARTY COMPLIANCE		
	A.	V.				UL498	FSUL WC596	CSA
RECEPTACLES								
L830R	30	480	Single Receptacle		L8-30R	•	•	•
L930R	30	600	Single Receptacle		L9-30R	•	•	•
CONNECTORS IP20 SUITABILITY								
L830C	30	480	Black Back, White Front Body	.225"-.1150"	L8-30R	•	•	•
L930C	30	600	Black Back, White Front Body	.225"-.1150"	L9-30R	•	•	•
PLUGS IP20 SUITABILITY								
L830P	30	480	Black Back, White Front Body	.225"-.1150"	L8-30P	•	•	•
L930P	30	600	Black Back, White Front Body	.225"-.1150"	L9-30P	•	•	•
FLANGED INLETS & OUTLETS								
L830FI	30	480	Gray Inlet		L8-30P	•		•
L830FO	30	480	Gray Outlet		L8-30R	•		•
L930FI	30	600	Gray Inlet		L9-30P	•		•
L930FO	30	600	Gray Outlet		L9-30R	•		•

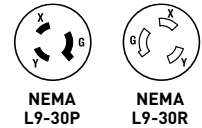
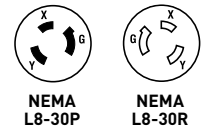

Reference Pages H-34 and H-35 for Accessories.

CATALOG NUMBER	DESCRIPTION	COLOR
WEATHERPROOF COVER		
WPG2	Cover for 20 and 30A Turnlok Flanged Inlets and Outlets	Gray
STAINLESS STEEL WALL PLATE		
SS720	Wall Plate for Locking Receptacles	302/304 S/S



SS720

INDUSTRIAL SPEC GRADE TURNLOK® LOCKING DEVICES

30 Amp NEMA L1030, L1130, L1230 & L1330

3 Pole, 3 Wire Non-Grounding 30A, 125/250V; 3ø, 250, 480 & 600V

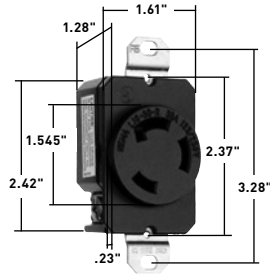

30A Receptacle

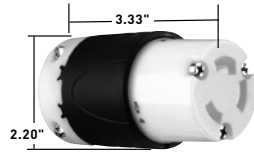

30A Connector

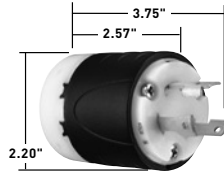

30A Plug

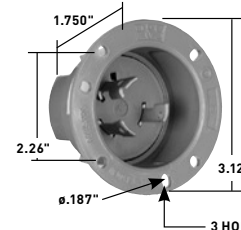

30A Flanged Inlet & Outlet

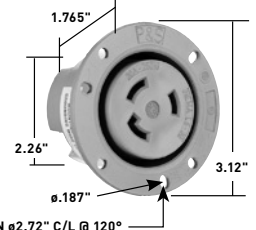

CATALOG NUMBER	RATING		DESCRIPTION/COLOR	CORD DIAMETER	NEMA CONFIG. NO.	3rd PARTY COMPLIANCE		
	A.	V.				UL498	FSUL WC596	CSA
RECEPTACLES								
L1030R	30	125/250	Single Receptacle		L10-30R	•	•	
L1130R	30	3ø, 250	Single Receptacle		L11-30R	•	•	
L1230R	30	3ø, 480	Single Receptacle		L12-30R	•	•	
L1330R	30	3ø, 600	Single Receptacle		L13-30R	•	•	
CONNECTORS IP20 SUITABILITY								
L1030C	30	125/250	Black Back, White Front Body	.225"-1.150"	L10-30R	•	•	
L1130C	30	3ø, 250	Black Back, White Front Body	.225"-1.150"	L11-30R	•	•	•
L1230C	30	3ø, 480	Black Back, White Front Body	.225"-1.150"	L12-30R	•	•	•
L1330C	30	3ø, 600	Black Back, White Front Body	.225"-1.150"	L13-30R	•	•	•
PLUGS IP20 SUITABILITY								
L1030P	30	125/250	Black Back, White Front Body	.225"-1.150"	L10-30P	•	•	
L1130P	30	3ø, 250	Black Back, White Front Body	.225"-1.150"	L11-30P	•	•	•
L1230P	30	3ø, 480	Black Back, White Front Body	.225"-1.150"	L12-30P	•	•	•
L1330P	30	3ø, 600	Black Back, White Front Body	.225"-1.150"	L13-30P	•	•	•
FLANGED INLETS & OUTLETS								
L1030FI	30	125/250	Gray Inlet		L10-30P	•		
L1030FO	30	125/250	Gray Outlet		L10-30R	•		•
L1130FI	30	3ø, 250	Gray Inlet		L11-30P	•		•
L1130FO	30	3ø, 250	Gray Outlet		L11-30R	•		•
L1230FI	30	3ø, 480	Gray Inlet		L12-30P	•		•
L1230FO	30	3ø, 480	Gray Outlet		L12-30R	•		•
L1330FI	30	3ø, 600	Gray Inlet		L13-30P	•		•
L1330FO	30	3ø, 600	Gray Outlet		L13-30R	•		•

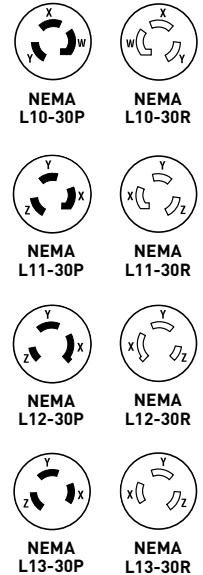

Reference Pages H-34 and H-35 for Accessories.

CATALOG NUMBER	DESCRIPTION	COLOR
WEATHERPROOF COVER		
WPG2	Cover for 20 and 30A Turnlok Flanged Inlets and Outlets	Gray
STAINLESS STEEL WALL PLATE		
SS720	Wall Plate for Locking Receptacles	302/304 S/S

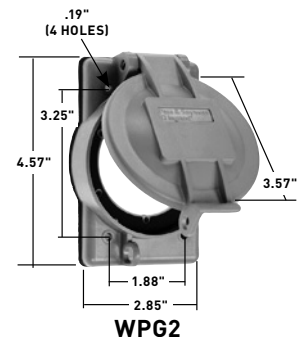

All devices listed on this page conform to NEMA WD-1 and WD-6.

INDUSTRIAL SPEC GRADE TURNLOK® LOCKING DEVICES

30 Amp NEMA L1430 & L1530 3 Pole, 4 Wire 30A, 125/250V; 3Ø, 250V

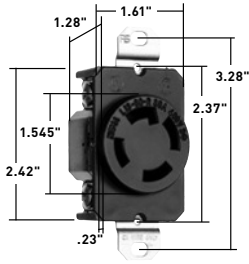

30A Receptacle



30A Connector

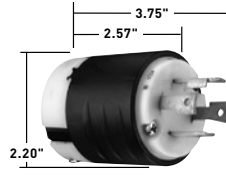

30A Plug

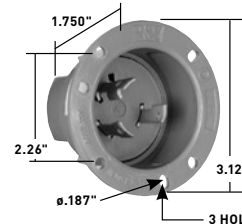

30A Flanged Inlet & Outlet

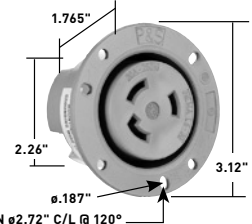

CATALOG NUMBER	RATING		DESCRIPTION/COLOR	CORD DIAMETER	NEMA CONFIG. NO.	3rd PARTY COMPLIANCE		
	A.	V.				UL498	FSUL WC596	CSA
RECEPTACLES								
L1430R	30	125/250	Single Receptacle		L14-30R	•	•	•
IGL1430R	30	125/250	Single Receptacle, Orange, Isolated Ground		L14-30R	•	•	•
L1530R	30	3Ø, 250	Single Receptacle		L15-30R	•	•	•
L1530RR	30	3Ø, 250	Single Receptacle, Red		L15-30R	•	•	•
IGL1530R	30	3Ø, 250	Single Receptacle, Orange, Isolated Ground		L15-30R	•	•	•
CONNECTORS IP20 SUITABILITY								
L1430C	30	125/250	Black Back, White Front Body	.225"-1.150"	L14-30R	•	•	•
CRL1430C	30	125/250	Yellow Back, White Front Body, Corrosion Resistant	.225"-1.150"	L14-30R	•	•	•
L1530C	30	3Ø, 250	Black Back, White Front Body	.225"-1.150"	L15-30R	•	•	•
PLUGS IP20 SUITABILITY								
L1430P	30	125/250	Black Back, White Front Body	.225"-1.150"	L14-30P	•	•	•
CRL1430P	30	125/250	Yellow Back, White Front Body, Corrosion Resistant	.225"-1.150"	L14-30P	•	•	•
L1530P	30	3Ø, 250	Black Back, White Front Body	.225"-1.150"	L15-30P	•	•	•
FLANGED INLETS & OUTLETS								
L1430FI	30	125/250	Gray Inlet		L14-30P	•	•	•
L1430FO	30	125/250	Gray Outlet		L14-30R	•	•	•
L1530FI	30	3Ø, 250	Gray Inlet		L15-30P	•	•	•
L1530FIBK	30	3Ø, 250	Black Inlet		L15-30P	•	•	•
L1530FO	30	3Ø, 250	Gray Outlet		L15-30R	•	•	•
L1530FOBK	30	3Ø, 250	Black Outlet		L15-30R	•	•	•

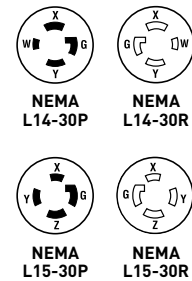

Reference Pages H-34 and H-35 for Accessories.

CATALOG NUMBER	DESCRIPTION
WEATHERPROOF LOCKING INLET KIT FOR GENERATOR APPLICATIONS	
L1430FIKIT	Kit includes 30A Locking Gray Flanged Inlet L1430FI, Weatherproof Cover WPG2, and Weatherproof Box WPB33

CATALOG NUMBER	DESCRIPTION	COLOR
WEATHERPROOF COVER		
WPG2	Cover for 20 and 30A Turnlok Flanged Inlets and Outlets	Gray
STAINLESS STEEL WALL PLATE		
SS720	Wall Plate for Locking Receptacles	302/304 S/S

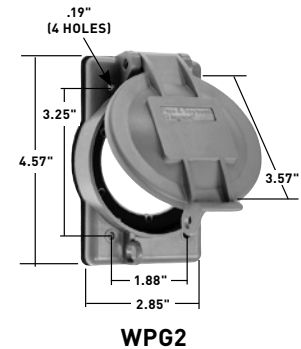

INDUSTRIAL SPEC GRADE TURNLOK® LOCKING DEVICES

INDUSTRIAL SPEC GRADE TURNLOK® LOCKING DEVICES

30 Amp NEMA L1630 & L1730 3 Pole, 4 Wire 30A; 3ø, 480 & 600V

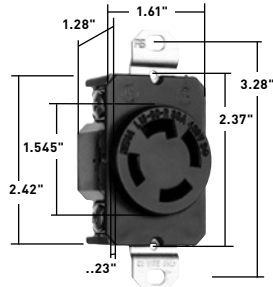

30A Receptacle



30A Connector

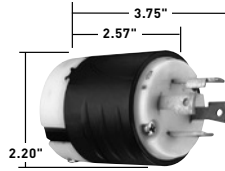

30A Plug

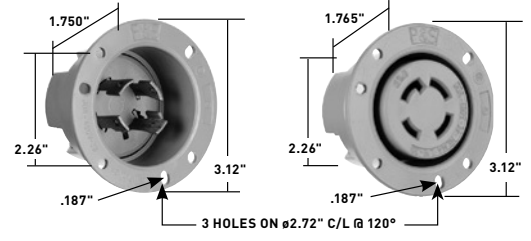

30A Flanged Inlet & Outlet

CATALOG NUMBER	RATING		DESCRIPTION/COLOR	CORD DIAMETER	NEMA CONFIG. NO.	3rd PARTY COMPLIANCE		
	A.	V.				UL498	FSUL WC596	CSA
RECEPTACLES								
L1630R	30	3ø, 480	Single Receptacle		L16-30R	•	•	•
L1730R	30	3ø, 600	Single Receptacle		L17-30R	•	•	•
CONNECTORS IP20 SUITABILITY								
L1630C	30	3ø, 480	Black Back, White Front Body	.225"-1.150"	L16-30R	•	•	•
L1730C	30	3ø, 600	Black Back, White Front Body	.225"-1.150"	L17-30R	•	•	•
PLUGS IP20 SUITABILITY								
L1630P	30	3ø, 480	Black Back, White Front Body	.225"-1.150"	L16-30P	•	•	•
L1730P	30	3ø, 600	Black Back, White Front Body	.225"-1.150"	L17-30P	•	•	•
FLANGED INLETS & OUTLETS								
L1630FI	30	3ø, 480	Gray Inlet		L16-30P	•		•
L1630FO	30	3ø, 480	Gray Outlet		L16-30P	•		•
L1730FI	30	3ø, 600	Gray Inlet		L17-30P	•		•
L1730FO	30	3ø, 600	Gray Outlet		L17-30P	•		•

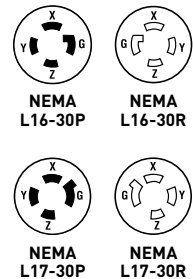

Reference Pages H-34 and H-35 for Accessories.

CATALOG NUMBER	DESCRIPTION	COLOR
WEATHERPROOF COVER		
WPG2	Cover for 20 and 30A Turnlok Flanged Inlets and Outlets	Gray
STAINLESS STEEL WALL PLATE		
SS720	Wall Plate for Locking Receptacles	302/304 S/S
WEATHERPROOF BOOTS		
L15RBC	Boot for 15A Locking Connector	Black
L15RBP	Boot for 15A Locking Plug	Black
L2030RBC	Boot for 20/30A Locking Connector	Black
L2030RBP	Boot for 20/30A Locking Plug	Black
CORROSION-RESISTANT BOOTS		
CRL2030RBC	Boot for 20/30A Locking Connector	Yellow
CRL2030RBP	Boot for 20/30A Locking Plug	Yellow
STRAIN RELIEF GRIPS		
FC22GL	Strain Relief Grip - .220"- .320"	
FC30GL	Strain Relief Grip - .300"- .430"	
FC40GL	Strain Relief Grip - .400"- .560"	
FC52GL	Strain Relief Grip - .520"- .730"	
FC70GL	Strain Relief Grip - .700"- .940"	
FC94GL	Strain Relief Grip - .940"- 1.250"	

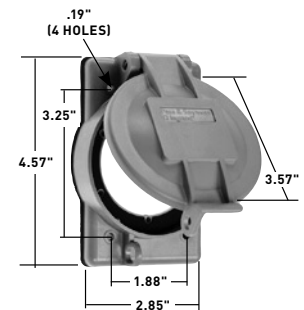

WPG2



L15RBC

All devices listed on this page conform to NEMA WD-1 and WD-6.

INDUSTRIAL SPEC GRADE TURNLOK® LOCKING DEVICES

30 Amp NEMA L1830, L1930 & L2030

4 Pole, 4 Wire Non-Grounding 30A, 3ØY, 120/208, 277/480 & 347/600V

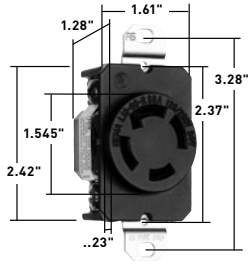

30A Receptacle



30A Connector

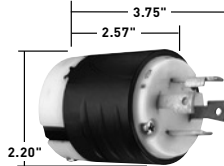

30A Plug

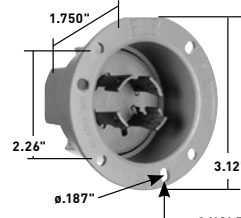

30A Flanged Inlet & Outlet

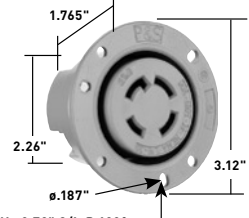

CATALOG NUMBER	RATING		DESCRIPTION/COLOR	CORD DIAMETER	NEMA CONFIG. NO.	3rd PARTY COMPLIANCE
	A.	V.				UL498
RECEPTACLES						
L1830R	30	3ØY, 120/208	Single Receptacle		L18-30R	•
L1930R	30	3ØY, 277/480	Single Receptacle		L19-30R	•
L2030R	30	3ØY, 347/600	Single Receptacle		L20-30R	•
CONNECTORS IP20 SUITABILITY						
L1830C	30	3ØY, 120/208	Black Back, White Front Body	.225"-1.150"	L18-30R	•
L1930C	30	3ØY, 277/480	Black Back, White Front Body	.225"-1.150"	L19-30R	•
L2030C	30	3ØY, 347/600	Black Back, White Front Body	.225"-1.150"	L20-30R	•
PLUGS IP20 SUITABILITY						
L1830P	30	3ØY, 120/208	Black Back, White Front Body	.225"-1.150"	L18-30P	•
L1930P	30	3ØY, 277/480	Black Back, White Front Body	.225"-1.150"	L19-30P	•
L2030P	30	3ØY, 347/600	Black Back, White Front Body	.225"-1.150"	L20-30P	•
FLANGED INLETS & OUTLETS						
L1830FI	30	3ØY, 120/208	Gray Inlet		L18-30P	•
L1830FO	30	3ØY, 120/208	Gray Outlet		L18-30R	•
L1930FI	30	3ØY, 277/480	Gray Inlet		L19-30P	•
L1930FO	30	3ØY, 277/480	Gray Outlet		L19-30R	•
L2030FI	30	3ØY, 347/600	Gray Inlet		L20-30P	•
L2030FO	30	3ØY, 347/600	Gray Outlet		L20-30R	•

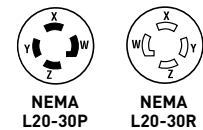
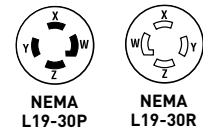
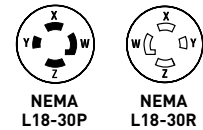

Reference Pages H-34 and H-35 for Accessories.

CATALOG NUMBER	DESCRIPTION	COLOR
WEATHERPROOF COVER		
WPG2	Cover for 20 and 30A Turnlok Flanged Inlets and Outlets	Gray
STAINLESS STEEL WALL PLATE		
SS720	Wall Plate for Locking Receptacles	302/304 S/S

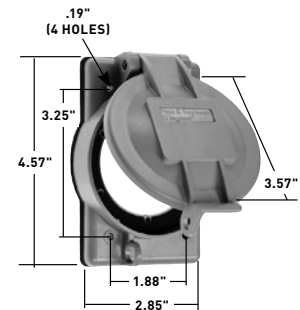

WPG2

INDUSTRIAL SPEC GRADE TURNLOK® LOCKING DEVICES

30 Amp L2130, L2230 & L2330 4 Pole, 5 Wire 30A, 3ØY, 120/208, 277/480 & 347/600V

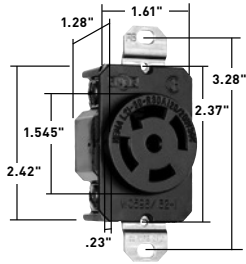

30A Receptacle



30A Connector

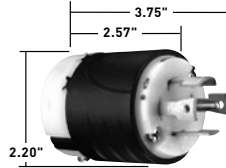

30A Plug

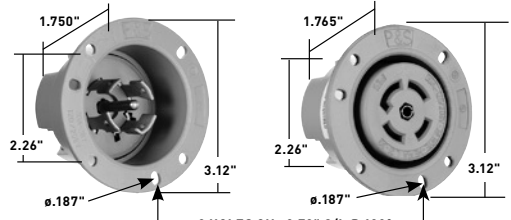

30A Flanged Inlet & Outlet

CATALOG NUMBER	RATING		DESCRIPTION/COLOR	CORD DIAMETER	NEMA CONFIG. NO.	3rd PARTY COMPLIANCE		
	A.	V.				UL498	FSUL WC596	CSA
RECEPTACLES								
L2130R	30	3ØY, 120/208	Single Receptacle		L21-30R	•	•	•
L2130RBL	30	3ØY, 120/208	Single Receptacle, Blue		L21-30R	•	•	•
IGL2130R	30	3ØY, 120/208	Single Receptacle, Orange, Isolated Ground		L21-30R	•		•
L2230R	30	3ØY, 277/480	Single Receptacle		L22-30R	•	•	•
IGL2230R	30	3ØY, 277/480	Single Receptacle, Orange, Isolated Ground		L22-30R	•		•
L2330R	30	3ØY, 347/600	Single Receptacle		L23-30R	•	•	•
IGL2330R	30	3ØY, 347/600	Single Receptacle, Orange, Isolated Ground		L23-30R	•		•
CONNECTORS IP20 SUITABILITY								
L2130C	30	3ØY, 120/208	Black Back, White Front Body	.225"-1.150"	L21-30R	•	•	•
L2230C	30	3ØY, 277/480	Black Back, White Front Body	.225"-1.150"	L22-30R	•	•	•
L2330C	30	3ØY, 347/600	Black Back, White Front Body	.225"-1.150"	L23-30R	•	•	•
PLUGS IP20 SUITABILITY								
L2130P	30	3ØY, 120/208	Black Back, White Front Body	.225"-1.150"	L21-30P	•	•	•
L2230P	30	3ØY, 277/480	Black Back, White Front Body	.225"-1.150"	L22-30P	•	•	•
L2330P	30	3ØY, 347/600	Black Back, White Front Body	.225"-1.150"	L23-30P	•	•	•
FLANGED INLETS & OUTLETS								
L2130FI	30	3ØY, 120/208	Gray Inlet		L21-30P	•		•
L2130FO	30	3ØY, 120/208	Gray Outlet		L21-30R	•		•
L2230FI	30	3ØY, 277/480	Gray Inlet		L22-30P	•		•
L2230FO	30	3ØY, 277/480	Gray Outlet		L22-30R	•		•
L2330FI	30	3ØY, 347/600	Gray Inlet		L23-30P	•		•
L2330FO	30	3ØY, 347/600	Gray Outlet		L23-30R	•		•

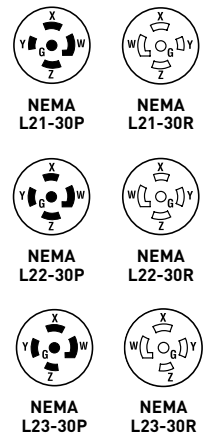

Reference Pages H-34 and H-35 for Accessories.

INDUSTRIAL SPEC GRADE TURNLOK® LOCKING DEVICES

Heavy-Duty Ground Continuity Monitoring (GCM) Plugs & Connectors

2 Pole, 3 Wire 15A, 125 & 250V & 277VAC



PSL515CGCM

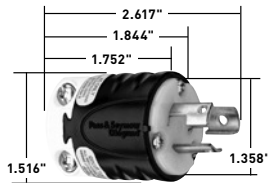

PSL515PGCM

Features – Heavy-Duty Turnlok® GCM

- Integral indication of ground continuity and power status. Continuous monitoring enhances personnel safety and adds convenience.
- Dual, bright LED indicators with 360° visibility. Green LEDs indicate proper ground continuity and power status. Red LEDs indicate ground continuity loss or reversed polarity. No LED indicates open hot, open neutral, or hot to ground cross. For 250V configurations: Hot to ground cross will be indicated by a green and red LED.
- NEMA configurations always visible for fast identification without disconnecting.
- Exclusive neoprene dust shield on devices seals cable entry. Optional weatherproof boots (sold separately).
- Chemical- and impact-resistant nylon housing features horizontal, easy-grip ribs on back body.
- Exclusive, rugged two-piece cord grip (15 Amp only) accepts a wide range of cord widths. Provides uniform pressure for superior retention of conductors.
- Recessed cord-grip screw reduces screwdriver slippage, improves safety. Quick-thread tri-drive assembly and cord-grip screws come backed-out and ready-to-wire.
- Color-coded terminal screws are backed-out for fast installation.
- Industrial-strength, brass alloy plug blades and connector contacts resist heat rise, provide excellent conductivity.

CATALOG NUMBER	RATING		DESCRIPTION	CORD DIAMETER	NEMA CONFIG. NO.	3rd PARTY COMPLIANCE	
	A.	V.				UL cULUS	FSUL WC596
2 POLE, 3 WIRE GROUNDING							
PSL515CGCM	15	125	Connector, Black & White	.230"-.720"	L5-15R	•	•
PSL515PGCM	15	125	Plug, Black & White	.230"-.720"	L5-15P	•	•
PSL615CGCM	15	250	Connector, Black & White	.230"-.720"	L6-15R	•	•
PSL615PGCM	15	250	Plug, Black & White	.230"-.720"	L6-15P	•	•
PSL715CGCM	15	277	Connector, Black & White	.230"-.720"	L7-15R	•	•
PSL715PGCM	15	277	Plug, Black & White	.230"-.720"	L7-15P	•	•



NEMA L5-15P



NEMA L5-15R



NEMA L6-15P



NEMA L6-15R



NEMA L7-15P



NEMA L7-15R



Green LED

Plug – There's proper ground continuity from the panel to the outlet and power's present.

Connector – Power's present and there's proper ground continuity throughout the cordset and back to the panel.



Red LED

Plug – Power's present, but there's a ground continuity fault or miswire between the receptacle and the panel.

Connector – Power's present, but there's a ground continuity fault or miswire in the cordset (or, if there's a red indication in the plug as well, between the receptacle and the panel). It's also possible there could be a problem in both.

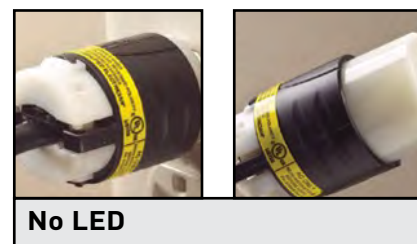

No LED

Plug – Power loss, open hot or neutral conductor, or hot/ground reversal.

Connector – Assuming power is present at the outlet, there's an open hot or open neutral conductor in the cordset, or a hot/ground reversal.

250V products will show red and green when hot and ground are reversed.

INDUSTRIAL SPEC GRADE TURNLOK® LOCKING DEVICES

Heavy-Duty Ground Continuity Monitoring (GCM) Plugs & Connectors

2 Pole, 3 Wire 20 & 30A; 125, 250, 277 & 347V; 3 Pole, 4 Wire 20 & 30A, 125/250V

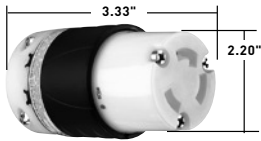

L630CGCM

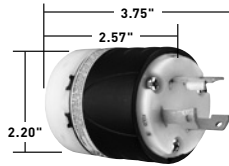

L630PGCM

Features

- Integral indication of ground continuity and power status. Continuous monitoring enhances personnel safety and adds convenience.
- Dual, bright LED indicators with 360° visibility. Green LEDs indicate proper ground continuity and power status. Red LEDs indicate ground continuity loss or reversed polarity. No LED indicates open hot, open neutral, or hot to ground cross. For 250V configurations: Hot to ground cross will be indicated by a green and red LED.
- NEMA configurations always visible for fast identification without disconnecting.
- Exclusive neoprene dust shield on devices seals cable entry. Optional weatherproof boots (sold separately).
- Chemical- and impact-resistant nylon housing features horizontal, easy-grip ribs on back body.
- Exclusive, rugged two-piece cord grip (15 Amp only) accepts a wide range of cord widths. Provides uniform pressure for superior retention of conductors.
- Recessed cord-grip screw reduces screwdriver slippage, improves safety. Quick-thread tri-drive assembly and cord-grip screws come backed-out and ready-to-wire.
- Color-coded terminal screws are backed-out for fast installation.
- Industrial-strength, brass alloy plug blades and connector contacts resist heat rise, provide excellent conductivity.

CATALOG NUMBER	RATING		DESCRIPTION	CORD DIAMETER	NEMA CONFIG. NO.	3rd PARTY COMPLIANCE	
	A.	V.				UL cULUS	FSUL WC596
2 POLE, 3 WIRE GROUNDING							
L520CGCM	20	125	Connector, Black & White	.225"-1.150"	L5-20R	•	•
L520PGCM	20	125	Plug, Black & White	.225"-1.150"	L5-20P	•	•
L530CGCM	30	125	Connector, Black & White	.225"-1.150"	L5-30R	•	•
L530PGCM	30	125	Plug, Black & White	.225"-1.150"	L5-30P	•	•
L620CGCM	20	250	Connector, Black & White	.225"-1.150"	L6-20R	•	•
L620PGCM	20	250	Plug, Black & White	.225"-1.150"	L6-20P	•	•
L630CGCM	30	250	Connector, Black & White	.225"-1.150"	L6-30R	•	•
L630PGCM	30	250	Plug, Black & White	.225"-1.150"	L6-30P	•	•
L720CGCM	20	277	Connector, Black & White	.225"-1.150"	L7-20R	•	•
L720PGCM	20	277	Plug, Black & White	.225"-1.150"	L7-20P	•	•
L730CGCM	30	277	Connector, Black & White	.225"-1.150"	L7-30R	•	•
L730PGCM	30	277	Plug, Black & White	.225"-1.150"	L7-30P	•	•
L3720CGCM	20	347	Connector, Black & White	.225"-1.150"	L24-20R	•	•
L3720PGCM	20	347	Plug, Black & White	.225"-1.150"	L24-20P	•	•
3 POLE, 4 WIRE GROUNDING							
L1420CGCM	20	125/250	Connector, Black & White	.225"-1.150"	L14-20R	•	•
L1420PGCM	20	125/250	Plug, Black & White	.225"-1.150"	L14-20P	•	•
L1430CGCM	30	125/250	Connector, Black & White	.225"-1.150"	L14-30R	•	•
L1430PGCM	30	125/250	Plug, Black & White	.225"-1.150"	L14-30P	•	•

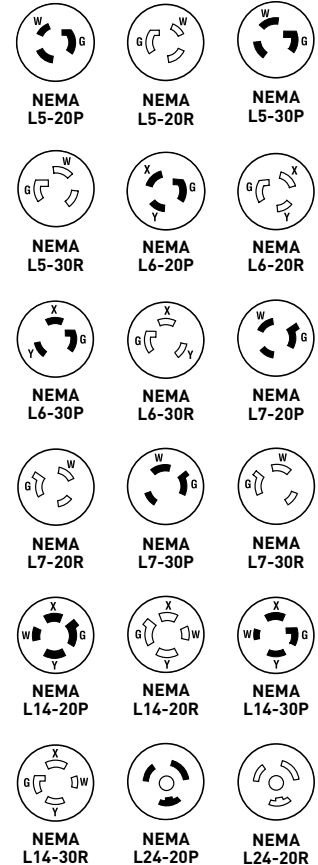

INDUSTRIAL SPEC GRADE TURNLOK® LOCKING DEVICES

Non-NEMA 3 Wire Grounding & Non-Grounding 10 & 15A, 125 & 250V; 20 & 30A, 125/250 & 250V

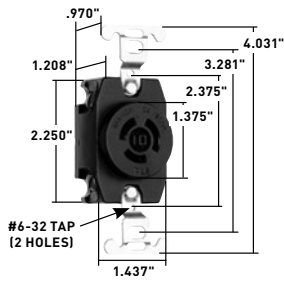

7582

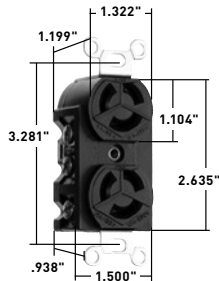

7580G

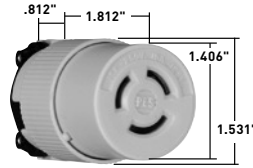

7555SS

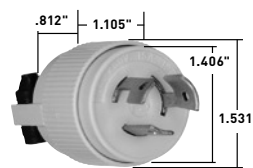

7554SS

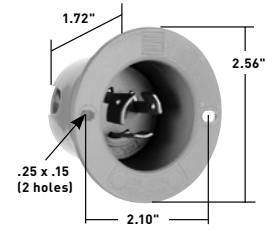

7556SS

CATALOG NUMBER	RATING		DESCRIPTION/COLOR	CORD DIAMETER	3rd PARTY COMPLIANCE		
	A.	V.			UL498	FSUL WC596	CSA
RECEPTACLES							
7582*	15	125	Single Receptacle				
	10	250					
7580	15	125	Duplex Receptacle				
	10	250					
7580G	15	125	Duplex Receptacle, Grounding				
	10	250					
7310*	20	125/250	Single Receptacle				
3330	30	125/250	Single Receptacle				
3330G	30	125/250	Single Receptacle, Grounding				
CONNECTORS IP20 SUITABILITY							
7555SS*	15	125	Yellow	.296"-.625"			
	10	250					
7555G	15	125	Yellow	.280"-.710"			
7313SS	20	125/250	Black Back, White Front Body	.225"-.750"	•	•	•
7313SSBK	20	125/250	Black Back, Black Front Body	.225"-.750"	•	•	•
3333SS	30	125/250	Black Back, White Front Body	.225"-.750"	•	•	•
PLUGS IP20 SUITABILITY							
52348DF	14	125-480	Black Back, White Front Body				
7554SS*	15	125	Yellow	.296"-.625"			
	10	250					
7572G	15	125	Yellow, Grounding	.280"-.710"			
7311SS	20	125/250	Black Back, White Front Body	.225"-.750"	•	•	•
7311SSBK	20	125/250	Black Back, Black Front Body	.225"-.750"	•	•	•
7311G	20	250	Yellow, Grounding	.410"-1.060"			
3331SS	30	125/250	Black Back, White Front Body	.225"-.750"	•	•	•
3331G	30	250	Yellow, Grounding	.410"-1.060"			
FLANGED INLETS & OUTLETS							
52347	14	125-480	Outlet				
7556SS*	15	125	Gray Inlet				
	10	250					
7557SS*	15	125	Gray Outlet				
	10	250					
3334SS	30	125/250	Gray Inlet		•		
3335SS	30	125/250	Gray Outlet		•		

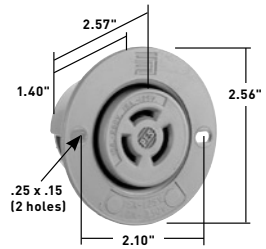

7557SS



Non-NEMA 7580, 7580G, 7582, 7555SS, 7557SS



Non-NEMA 7554SS, 7556SS, 7572G



Non-NEMA 52348DF



Non-NEMA 52347



Non-NEMA 7310, 7313SS



Non-NEMA 7311SS, 7311G



Non-NEMA 3331SS, 3334SS, 3331G



Non-NEMA 3330, 3330G, 3333SS, 3335SS

INDUSTRIAL SPEC GRADE TURNLOK® LOCKING DEVICES

*For replacement use only. Reference Pages H-34 and H-35 for Accessories.

INDUSTRIAL SPEC GRADE TURNLOK® LOCKING DEVICES

20 Amp Non-NEMA 3 Pole, 4 Wire 20A, 3 ϕ Y, 250V; 10A, 600V; 4 Pole, 4 Wire 20A, 3 ϕ Y, 120/208V

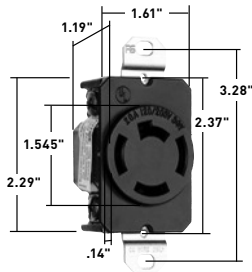

20A Receptacle



20A Connector

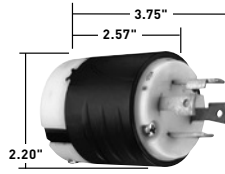

20A Plug

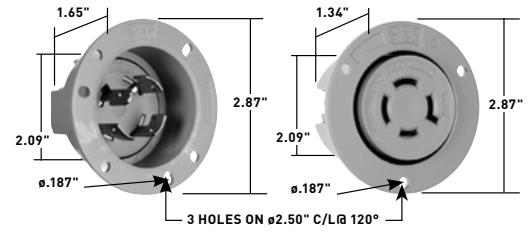

20A Flanged Inlet & Outlet

CATALOG NUMBER	RATING		DESCRIPTION/COLOR	CORD DIAMETER	3rd PARTY COMPLIANCE		
	A.	V.			UL 498	FSUL WC596	CSA
RECEPTACLES							
7410G*	20 10	3 ϕ Y, 250 600	Single Receptacle, Grounded			•	
7410	20	3 ϕ Y, 120/208	Single Receptacle		•	•	
CONNECTORS IP20 SUITABILITY							
7413G*	20 10	3 ϕ Y, 250 600	Yellow	.333"-1.060"			
7413SS	20	3 ϕ Y, 120/208	Black Back, White Front Body	.225"-1.150"	•	•	
PLUGS IP20 SUITABILITY							
7411G*	20 10	3 ϕ Y, 250 600	Yellow	.333"-1.060"			
7411SS	20	3 ϕ Y, 120/208	Black Back, White Front Body	.225"-1.150"	•	•	
FLANGED INLETS & OUTLETS							
7408SS	20	3 ϕ Y, 120/208	Gray Inlet		•		
7409SS	20	3 ϕ Y, 120/208	Gray Outlet		•		

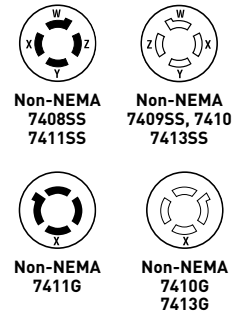

*For replacement use only.
Reference Pages H-34 and H-35 for Accessories.

CATALOG NUMBER	DESCRIPTION	COLOR
WEATHERPROOF COVER		
WPG2	Cover for 20 and 30A Turnlok Flanged Inlets and Outlets	Gray
STAINLESS STEEL WALL PLATE		
SS720	Wall Plate for Locking Receptacles	302/304 S/S
WEATHERPROOF BOOTS		
L15RBC	Boot for 15A Locking Connector	Black
L15RBP	Boot for 15A Locking Plug	Black
L2030RBC	Boot for 20/30A Locking Connector	Black
L2030RBP	Boot for 20/30A Locking Plug	Black
CORROSION-RESISTANT BOOTS		
CRL2030RBC	Boot for 20/30A Locking Connector	Yellow
CRL2030RBP	Boot for 20/30A Locking Plug	Yellow

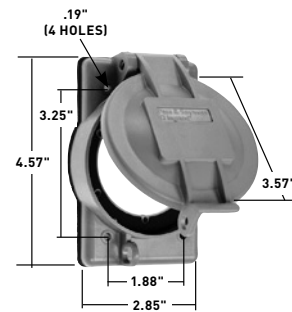

WPG2



L15RBC



**L2030RBC
CRL2030RBC**

INDUSTRIAL SPEC GRADE TURNLOK® LOCKING DEVICES

30 Amp Non-NEMA 3 Pole, 4 Wire 30A, 3ØY 250V; 10A, 600V; 4 Pole, 4 Wire 30A, 3ØY, 120/208V

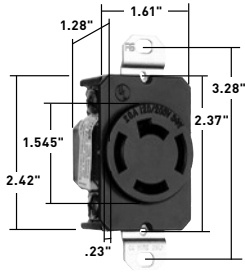

30A Receptacle



30A Connector

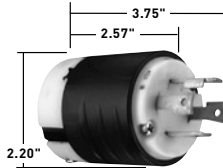

30A Plug

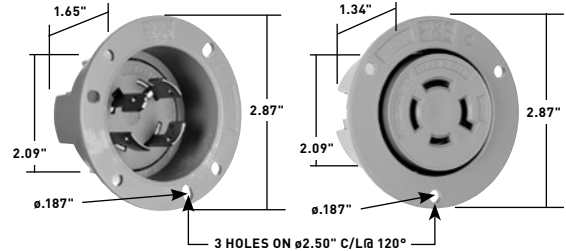

20A Flanged Inlet & Outlet

CATALOG NUMBER	RATING		DESCRIPTION/COLOR	CORD DIAMETER	3rd PARTY COMPLIANCE		
	A.	V.			UL498	FSUL WC596	CSA
RECEPTACLES							
3430	30	3ØY, 120/208	Single Receptacle		•	•	
CONNECTORS IP20 SUITABILITY							
3433SS	30	3ØY, 120/208	Black Back, White Front Body	.225"-1.150"	•	•	
PLUGS IP20 SUITABILITY							
3431G*	30 10	3ØY, 250 600	Yellow	.333"-1.060"			
3431SS	30	3ØY, 120/208	Black Back, White Front Body	.225"-1.150"	•	•	
FLANGED INLETS & OUTLETS							
3434SS	20	3ØY, 120/208	Gray Inlet		•		
3435SS	20	3ØY, 120/208	Gray Outlet		•		



Non-NEMA
3431SS
3434SS



Non-NEMA
3430, 3433SS
3435SS



Non-NEMA
3431G



Non-NEMA
3430G
3433G

*For replacement use only.
Reference Pages H-34 and H-35 for Accessories.

CATALOG NUMBER	DESCRIPTION	COLOR
WEATHERPROOF COVER		
WPG2	Cover for 20 and 30A Turnlok Flanged Inlets and Outlets	Gray
STAINLESS STEEL WALL PLATE		
SS720	Wall Plate for Locking Receptacles	302/304 S/S

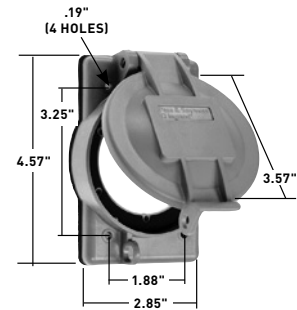

WPG2

INDUSTRIAL SPEC GRADE TURNLOK® LOCKING DEVICES

Power Interrupting Devices 2 Pole, 3 Wire 20A, 125V Hospital Use; 2 Pole, 3 Wire 20A, 125V; 2 Pole, 3 Wire 20A, 125V; 10A, 250VDC, 480VAC

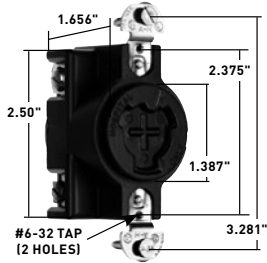

23000HG

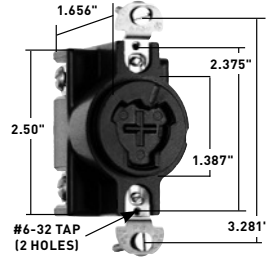

23000

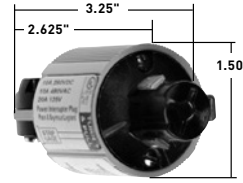

23005N

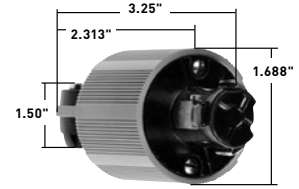

**23056N
23035N**

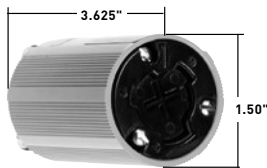

23002N

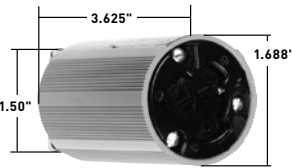

23054N

CATALOG NUMBER	RATING		DESCRIPTION	CORD DIAMETER	3rd PARTY COMPLIANCE
	A.	V.			UL UL498
RECEPTACLES					
23000HG	20	125	Hospital Use, Non-Metallic		•
23050	20	125	Hospital Use, Black Bakelite		•
23000G	20 10	125 250VDC, 480VAC	Grounding, Non-Metallic		•
23000	20 10	125 250VDC, 480VAC	Non-Grounding, Non-Metallic		•
CONNECTORS					
23054N	20	125	Hospital Use, Non-Metallic	.250"-.656"	•
23002N	20 10	125 250VDC, 480VAC	Non-Metallic	.250"-.656"	•
PLUGS					
23056N	20	125	Hospital Use, Non-Metallic	.250"-.656"	•
23035N	20	125	Non-Metallic	.250"-.656"	•
23005N	20 10	125 250VDC, 480VAC	Non-Metallic	.250"-.656"	•

INDUSTRIAL SPEC GRADE TURNLOK® LOCKING DEVICES

INDUSTRIAL SPEC GRADE TURNLOK® LOCKING DEVICES

Power Interrupting Devices

3 Pole, 4 Wire 30A, 480V; 3 Pole, 4 Wire 30A, 600VAC; 20A, 250VDC; 3 Pole, 4 Wire 60A, 600V

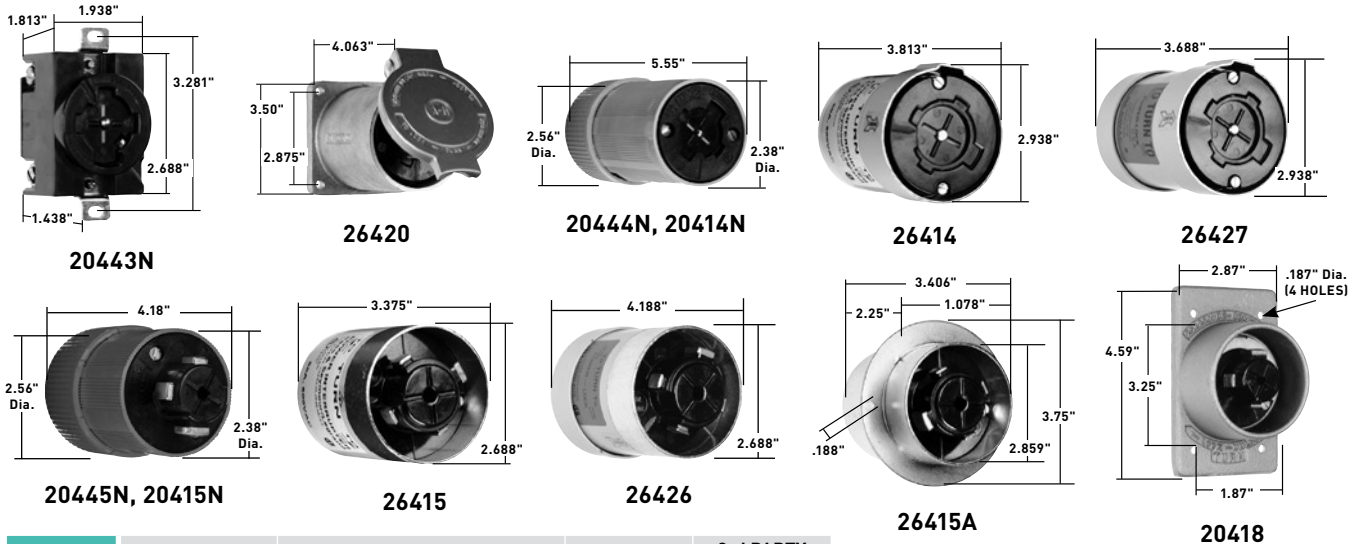

CATALOG NUMBER	RATING		DESCRIPTION	CORD DIAMETER	3rd PARTY COMPLIANCE UL UL498
	A.	V.			
RECEPTACLES					
20443N	30	480	Non-Metallic		
20403N	30 20	600VAC 250VDC	Non-Metallic		•
21420	30 20	600VAC 250VDC	Angled, 3/4" Tap for Conduit, Diecast		•
26420	60	600	Die-Cast with Lift Lid Enclosure		•
CONNECTORS					
20444N	30	480	Non-Metallic	.400"-1.062"	
20414	30 20	600VAC 250VDC	Metallic	.562"-1.000"	
20414N	30 20	600VAC 250VDC	Non-Metallic	.400"-1.062"	•
21414	30 20	600VAC 250VDC	Metallic with Rubber Cord Grip	.360"-0.484"	
26414	60	600	Metallic	.750"-1.250"	
26427	60	600	Metallic	.750"-1.250"	•
PLUGS					
20445N	30	480	Non-Metallic	.400"-1.062"	
20415	30 20	600VAC 250VDC	Metallic	.562"-1.000"	
20415N	30 20	600VAC 250VDC	Non-Metallic	.400"-1.062"	
21415	30 20	600VAC 250VDC	Metallic with Rubber Cord Grip	.360"-0.484"	
21426	30 20	600VAC 250VDC	Metallic with Rubber Cord Grip	.484"-0.750"	
21426S	30 20	600VAC 250VDC	Metallic with Tab with Rubber Cord Grip	.484"-0.750"	
26415	60	600	Metallic	.750"-1.250"	
26426	60	600	Metallic	.750"-1.250"	•
FLANGED INLETS & OUTLETS					
20418	30 20	600VAC 250VDC	Inlet, Die-Cast for FS and FD Box		•
26415A	60	600	Inlet, Die-Cast		

CATALOG NUMBER	DESCRIPTION
ACCESSORIES	
WPG1	Weatherproof Cover for 20403N
26400	Box and Plate for 26420
26401	Box only for 26404 Angle Adapter
26402	Mounting Plate only for 26401 Box
26404	45° Angle Adapter
20446N	Red Nylon Cover and Gasket for 20443N
20416N	Nylon Cover and Gasket for 20403N
20417N	Aluminum Cover (No Gasket) for 20403N

INDUSTRIAL SPEC GRADE TURNLOK® LOCKING DEVICES

Power Interrupting Devices 4 Pole, 5 Wire 30A, 600VAC; 20A 250VDC; 4 Pole, 5 Wire 60A, 600V

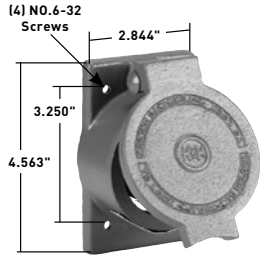

25250

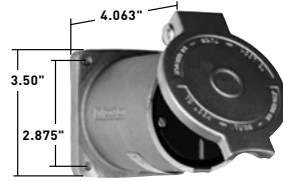

26520

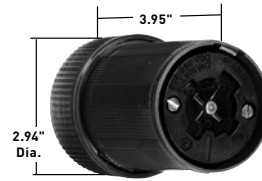

25414N

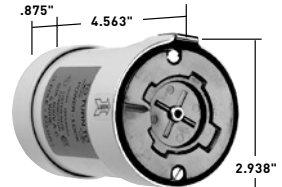

26527

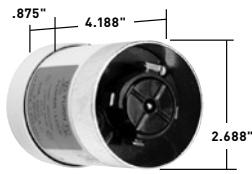

26526

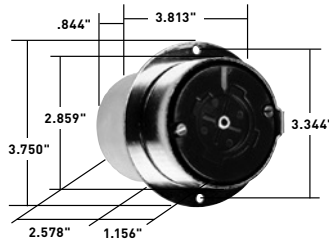

26514A

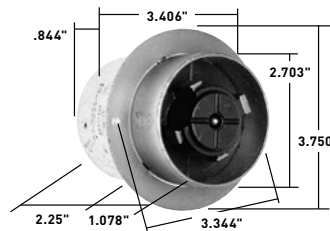

26515A

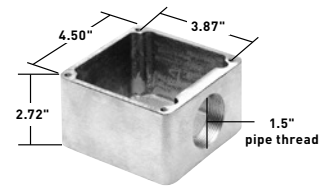

26401

CATALOG NUMBER	RATING		DESCRIPTION	CORD DIAMETER	3rd PARTY COMPLIANCE
	A.	V.			UL498
RECEPTACLES					
25250	30 20	600VAC; 250VDC	Die-Cast with Lift Lid Enclosure		
26520	60	600	Die-Cast with Lift Lid Enclosure		•
CONNECTORS					
25414N	30 20	600VAC; 250VDC	Non-Metallic	.625"-1.000" .725"-1.250"	
25414	30 20	600VAC; 250VDC	Metallic	.625"-1.000"	
26514	60	600	Metallic	.750"-1.250"	•
26527	60	600	Metallic with Rubber Cord Grip	.750"-1.250"	•
PLUGS					
25415N	30 20	600VAC; 250VDC	Non-Metallic	.625"-1.000" .725"-1.250"	
25415	30 20	600VAC; 250VDC	Metallic	.625"-1.000"	
26515	60	600	Metallic	.750"-1.250"	•
26526	60	600	Metallic with Rubber Cord Grip	.750"-1.250"	•
FLANGED INLETS & OUTLETS					
26515A	60	600	Inlet, Die-Cast		•
26514A	60	600	Outlet, Die-Cast		•

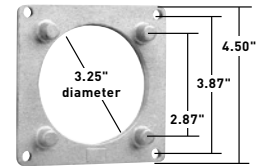

26402

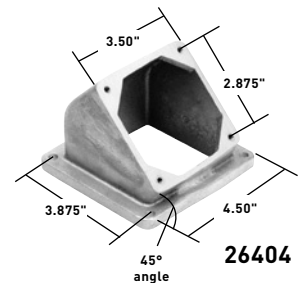

26404

CATALOG NUMBER	DESCRIPTION	CATALOG NUMBER	DESCRIPTION
ACCESSORIES			
26400	Box and Plate for 26520	26402	Mounting Plate only for 26401 Box
26401	Box only for 26404 Angle Adapter	26404	45° Angle Adapter

All devices listed on this page conform to NEMA WD-1 and WD-6.

INDUSTRIAL SPEC GRADE TURNLOK® LOCKING DEVICES

California Standard & Corrosion-Resistant

3 Wire Grounding 50A, 125, 250 & 480V; 250VDC, 600VAC

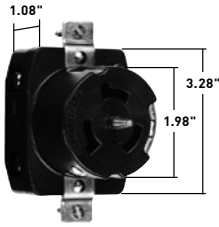

California Standard Receptacle



California Standard Connector

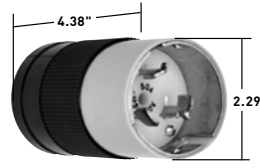

California Standard Plug

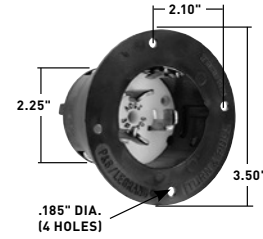

California Standard Flanged Inlet

CATALOG NUMBER	RATING		DESCRIPTION/COLOR	CORD DIAMETER	3rd PARTY COMPLIANCE		
	A.	V.			UL498	FSUL WC596	CSA
RECEPTACLES							
CR6370	50	125	Corrosion-Resistant		•		•
CS6370	50	125	California Standard		•		•
CS8269	50	250	California Standard		•		•
CS8469	50	480	California Standard		•		•
3771	50	250VDC, 600VAC	Corrosion-Resistant		•		•
CONNECTORS IP20 SUITABILITY							
CR6360	50	125	Corrosion-Resistant	.680"-1.125"	•		•
CS6360	50	125	California Standard	.680"-1.125"	•		•
CS8264	50	250	California Standard	.680"-1.125"	•		•
CS8464	50	480	California Standard	.680"-1.125"	•		•
3762	50	250VDC, 600VAC	Corrosion-Resistant	.680"-1.125"	•		•
PLUGS IP20 SUITABILITY							
CR6361	50	125	Corrosion-Resistant	.680"-1.125"	•		•
CS6361	50	125	California Standard	.680"-1.125"	•		•
CS8265	50	250	California Standard	.680"-1.125"	•		•
CS8465	50	480	California Standard	.680"-1.125"	•		•
3763M	50	250VDC, 600VAC	Corrosion-Resistant	.680"-1.125"	•		•
FLANGED INLETS							
CS6377	50	125	California Standard		•		•
CS8275	50	250	California Standard		•		•
CS8475	50	480	California Standard		•		•
3777	50	250VDC, 600VAC	Corrosion-Resistant		•		•

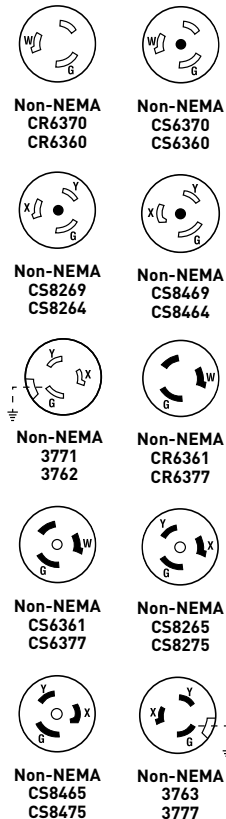

Reference Pages H-34 and H-35 for Accessories.

CATALOG NUMBER	DESCRIPTION
ACCESSORIES	
7770	Weatherproof Cover for 50A Locking Receptacles, Thermoplastic
7770GRY	Gray Weatherproof Cover for 50A Locking Receptacles, Thermoplastic
CR7716N	Weatherproof Boot, 50A Locking Connector
CR7717N	Weatherproof Boot, 50A Locking Plug

Note: 7770 covers not to be used with flanged devices.

All devices listed on this page conform to NEMA WD-1 and WD-6.

INDUSTRIAL SPEC GRADE TURNLOK® LOCKING DEVICES

California Standard & Corrosion-Resistant

4 Wire Grounding 50A, 125/250V; 3ø, 250 & 480V; 250VDC, 600VAC

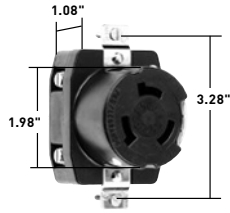

Corrosion-Resistant Receptacle



Corrosion-Resistant Connector



Corrosion-Resistant Plug

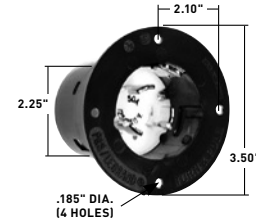

Corrosion-Resistant Flanged Inlet

CATALOG NUMBER	RATING		DESCRIPTION/COLOR	CORD DIAMETER	3rd PARTY COMPLIANCE		
	A.	V.			UL498	FSUL WC596	CSA
RECEPTACLES							
CR6369	50	125/250	Corrosion-Resistant		•		•
CS6369	50	125/250	California Standard		•		•
CS8369	50	3ø, 250	California Standard		•		•
CS8169	50	3ø, 480	California Standard		•		•
3769	50	250VDC, 600VAC	Corrosion-Resistant		•		•
7379*	50	250VDC, 600VAC	Corrosion-Resistant		•		•
CONNECTORS							
CR6364	50	125/250	Corrosion-Resistant	.680"-1.125"	•		•
CS6364	50	125/250	California Standard	.680"-1.125"	•		•
CS8364	50	3ø, 250	California Standard	.680"-1.125"	•		•
CS8164	50	3ø, 480	California Standard	.680"-1.125"	•		•
3764	50	250VDC, 600VAC	Corrosion-Resistant	.680"-1.125"	•		•
7764*	50	250VDC, 600VAC	Corrosion-Resistant	.680"-1.125"	•		•
PLUGS							
CR6365	50	125/250	Corrosion-Resistant	.680"-1.125"	•		•
CS6365	50	125/250	California Standard	.680"-1.125"	•		•
CS8365	50	3ø, 250	California Standard	.680"-1.125"	•		•
CS8165	50	3ø, 480	California Standard	.680"-1.125"	•		•
3765	50	250VDC, 600VAC	Corrosion-Resistant	.680"-1.125"	•		•
7765*	50	250VDC, 600VAC	Corrosion-Resistant	.680"-1.125"	•		•
FLANGED INLETS							
CR6375	50	125/250	Corrosion-Resistant		•		•
CS6375	50	125/250	California Standard		•		•
CS8375	50	3ø, 250	California Standard		•		•
CS8175	50	3ø, 480	California Standard		•		•
CS8177	50	3ø, 480	California Standard with Fliplid		•		•
3775	50	250VDC, 600VAC	Corrosion-Resistant		•		•
7958P*	50	250VDC, 600VAC	Corrosion-Resistant		•		•

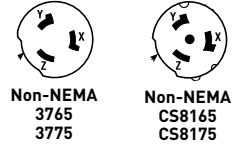
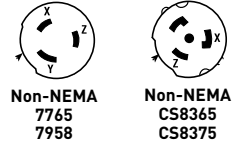
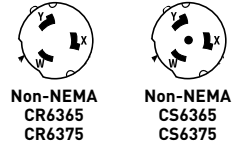
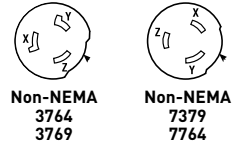
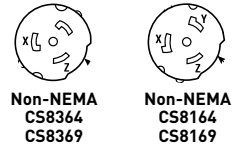
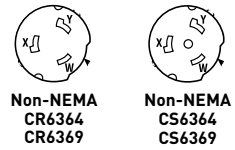

*Devices for replacement use only in existing installations. Reference Pages H-34 and H-35 for Accessories.

CATALOG NUMBER	DESCRIPTION
ACCESSORIES	
7770	Weatherproof Cover for 50A Locking Receptacles, Thermoplastic
7770GRY	Gray Weatherproof Cover for 50A Locking Receptacles, Thermoplastic
CR7716N	Weatherproof Boot, 50A Locking Connector
CR7717N	Weatherproof Boot, 50A Locking Plug

Note: 7770 covers not to be used with flanged devices.

All devices listed on this page conform to NEMA WD-1 and WD-6.

INDUSTRIAL SPEC GRADE TURNLOK[®] LOCKING DEVICES

Accessories

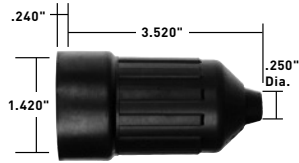
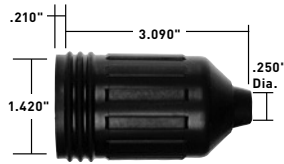
L15RBC

L15RBP

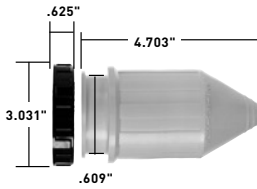
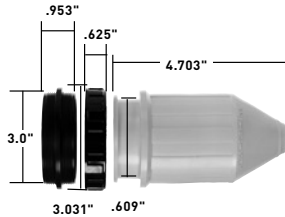
**L2030RBC
CRL2030RBC**

**L2030RBP
CRL2030RBP**

CR7717N

CR7716N

DC1

CATALOG NUMBER	DESCRIPTION	COLOR
WEATHERPROOF BOOTS		
L15RBC	Boot for 15A Locking Connector	Black
L15RBP	Boot for 15A Locking Plug	Black
L2030RBC	Boot for 20/30A Locking Connector	Black
L2030RBP	Boot for 20/30A Locking Plug	Black
CORROSION-RESISTANT BOOTS		
CRL2030RBC	Boot for 20/30A Locking Connector	Yellow
CRL2030RBP	Boot for 20/30A Locking Plug	Yellow
CR7716N	Boot for 50A Locking Connector	Yellow
CR7717N	Boot for 50A Locking Plug	Yellow
DUST COVERS		
DC1	Replacement Cover, to be used with "old-style" 20 and 30A Turnlok Plugs and Connectors only.	Black

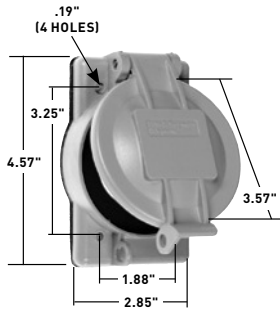
INDUSTRIAL SPEC GRADE TURNLOK® LOCKING DEVICES

Accessories



WPG1

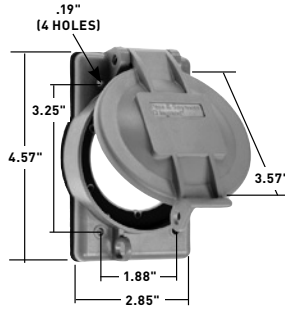

WPG2

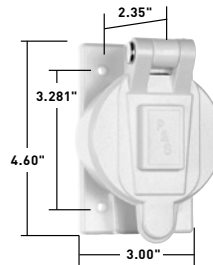

7770

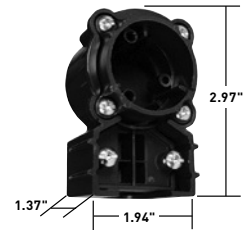

L15AN

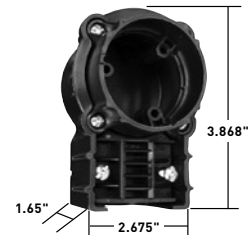

L20303AN

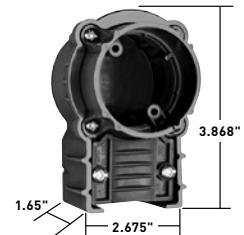

L203045AN

CATALOG NUMBER	DESCRIPTION	COLOR
WEATHERPROOF COVERS		
WPG1	Cover for 15A Turnlok Flanged Inlets and Outlets	Gray
WPG2	Cover for 20 and 30A Turnlok Flanged Inlets and Outlets	Gray
7770	Cover for 50A Locking Receptacle, Thermoplastic	Yellow
7770GRY	Cover for 50A Locking Receptacle, Thermoplastic	Gray
7425Y	Cover for 20 and 30A Receptacles, Thermoplastic	Yellow
7425GRY	Cover for 20 and 30A Receptacles, Thermoplastic	Gray
3720FS	Clear Cover for Single Receptacle, Thermoplastic	Gray
3710FS	Clear Cover for Duplex Receptacle, Thermoplastic	Gray
3722FS	Clear Cover for Power Outlet, Thermoplastic	Gray
3760	Cover for Single Receptacle	Gray
STAINLESS STEEL PLATES		
SS7	Plate for Single Receptacle	S/S
SS8	Plate for Duplex Receptacle	S/S
SS720	Plate for Locking Receptacle	S/S
WP7	Dustproof Cover for Single Receptacle	S/S
WP8	Dustproof Cover for Duplex Receptacle	S/S
STRAIN RELIEF GRIPS FOR PLUGS & CONNECTORS		
FC22GL	Strain Relief Grip - .220"-.320"	
FC30GL	Strain Relief Grip - .300"-.430"	
FC40GL	Strain Relief Grip - .400"-.560"	
FC52GL	Strain Relief Grip - .520"-.730"	
FC70GL	Strain Relief Grip - .700"-.940"	
FC94GL	Strain Relief Grip - .940"-1.250"	
TURNLOK RIGHT ANGLE ADAPTER		
L15AN	15A Turnlok Right Angle Adapter	Black
L20303AN	20 and 30A 3 Wire Turnlok Right Angle Adapter	Black
L203045AN	20 and 30A 4 and 5 Wire Turnlok Right Angle Adapter	Black

INDUSTRIAL SPEC GRADE TURNLOK® LOCKING DEVICES

INDUSTRIAL SPEC GRADE TURNLOK® LOCKING DEVICES

Common Marine Applications



CATALOG NUMBER	RATING		DESCRIPTION/COLOR	CORD DIAMETER	NEMA CONFIG.	3rd PARTY COMPLIANCE		
	A.	V.				UL498	FSUL WC596	CSA
30A 125V 2 POLE 3 WIRE MARINE APPLICATION								
CRL530R	30	125	Corrosion-Resistant Single Receptacle, Yellow	.225"-1.150"	L5-30R	•	•	•
7425Y			Corrosion-Resistant Flip-Lid Cover for 20/30A Locking Receptacles, Yellow					
CRL530P	30	125	Corrosion-Resistant Plug, Yellow Back, White Front Body		L5-30P	•	•	•
CRL2030RBP			Boot for 20/30A Locking Plug, Yellow					
CRL530C	30	125	Corrosion-Resistant Connector, Yellow Back, White Front Body		L5-30R	•	•	•
CRL2030RBC			Boot for 20/30A Locking Connector, Yellow					
50A 125V 2 POLE 3 WIRE MARINE APPLICATION								
CR6370	50	125	Corrosion-Resistant Receptacle	.680"-1.125"		•		•
7770			Weatherproof Cover for 50A Locking Receptacles, Thermoplastic					
CR6361	50	125	Corrosion-Resistant Plug			•		•
CR7717N			Weatherproof Boot, 50A Locking Plug					
CR6360	50	125	Corrosion-Resistant Connector			•		•
CR7716N			Weatherproof Boot, 50A Locking Connector					
50A 125/250V 3 POLE 4 WIRE MARINE APPLICATION								
CR6369	50	125/250	Corrosion-Resistant Receptacle	.680"-1.125"		•		•
7770			Weatherproof Cover for 50A Locking Receptacles, Thermoplastic					
CR6365	50	125/250	Corrosion-Resistant Plug			•		•
CR7717N			Weatherproof Boot, 50A Locking Plug					
CR6364	50	125/250	Corrosion-Resistant Connector			•		•
CR7716N			Weatherproof Boot, 50A Locking Connector					



NEMA L5-30R



NEMA L5-30P

INDUSTRIAL SPEC GRADE TURNLOK[®] LOCKING DEVICES

Plugs & Connectors Product Specifications & Performance

15 Amp Turnlok Plugs & Connectors

PLUGS	Standard Product	Corrosion-Resistant
Back Body	Nylon	Nylon
Front Body	Nylon	Nylon
Terminal Chamber	Polycarbonate	Polycarbonate
Cord Clamp	Nylon	Nylon
Insert	Nylon	Nylon
Blades	Brass	Nickel-Plated Brass
Terminal Clamp	Zinc-Plated Steel	Nickel-Plated Steel
Terminal Screws	Nickel- or Brass-Plated Steel	Nickel-Plated Steel
Ground Screws	Nickel-Plated Steel	Nickel-Plated Steel
Cord Clamp Screws	Nickel-Plated Steel	Nickel-Plated Steel
Assembly Screws	Nickel-Plated Steel	Nickel-Plated Steel
CONNECTORS		
Back Body	Nylon	Nylon
Front Body	Nylon	Nylon
Terminal Chamber	Polycarbonate	Polycarbonate
Cord Clamp	Nylon	Nylon
Insert	Nylon	Nylon
Contacts	Brass	Nickel-Plated Brass
Terminal Clamp	Zinc-Plated Steel	Nickel-Plated Steel
Terminal Screws	Nickel- or Brass-Plated Steel	Nickel-Plated Steel
Ground Screws	Nickel-Plated Steel	Nickel-Plated Steel
Cord Clamp Screws	Nickel-Plated Steel	Nickel-Plated Steel
Assembly Screws	Nickel-Plated Steel	Nickel-Plated Steel
PERFORMANCE		
Electrical		
Dielectric Withstand Voltage	1600V minimum	
Maximum Working Voltage	277VAC	
Current Interrupting	Certified for current interrupting at full-rated current	
Temperature Rise	30°C maximum after 50 cycles at 150% rated current	
Mechanical		
Cord Accommodations	Round portable service cords of diameters in accordance with the device rating as defined in UL62	
Cord Grip Accommodations	.230"-.720" diameter	
Terminal Identification	Green = Ground, White = Neutral, Brass = Hot	
Terminal Accommodation	#18 AWG min. – #10 AWG max.	
Product Identification	Amperage, Voltage, 3rd Party Compliance, NEMA Configuration	
Environmental		
Flammability	UL94 V2	
Operating Temperature	Maximum continuous: +75°C, Minimum: -40°C without impact	

INDUSTRIAL SPEC GRADE TURNLOK® LOCKING DEVICES

Plugs & Connectors Product Specifications & Performance

20 & 30 Amp Turnlok Plugs & Connectors

PLUGS	Standard Product	Corrosion-Resistant
Back Body	Super Tough Nylon	Super Tough Nylon
Front Body	Nylon	Nylon
Terminal Chamber	Polycarbonate	Polycarbonate
Cord Clamp	Nylon	Nylon
Insert	Nylon	Nylon
Dust Shield	Neoprene	Neoprene
Blades	Brass	20A = Nickel-Plated Brass 30A = Tin-Plated Brass
Terminal Clamp	20A = Nickel-Plated Steel 30A = Brass	20A = Nickel-Plated Steel 30A = Nickel-Plated Brass
Terminal Screws	Brass	Nickel-Plated Brass
Ground Screws	Brass	Nickel-Plated Brass
Cord Clamp Screws	Nickel-Plated Steel	Nickel-Plated Steel
Assembly Screws	Nickel-Plated Steel	Nickel-Plated Steel
CONNECTORS		
Back Body	Super Tough Nylon	Super Tough Nylon
Front Body	Nylon	Nylon
Terminal Chamber	Polycarbonate	Polycarbonate
Cord Clamp	Nylon	Nylon
Insert	Nylon	Nylon
Dust Shield	Neoprene	Neoprene
Contacts	Brass	20A = Nickel-Plated Brass 30A = Tin-Plated Brass
Terminal Clamp	20A = Nickel-Plated Steel 30A = Brass	20A = Nickel-Plated Steel 30A = Nickel-Plated Brass
Terminal Screws	Brass	Nickel-Plated Brass
Ground Screws	Brass	Nickel-Plated Brass
Cord Clamp Screws	Nickel-Plated Steel	Nickel-Plated Steel
Assembly Screws	Nickel-Plated Steel	Nickel-Plated Steel
PERFORMANCE		
Electrical		
Dielectric Withstand Voltage	2200V minimum	
Maximum Working Voltage	600VAC	
Current Interrupting	Certified for current interrupting at full-rated current	
Temperature Rise	30°C maximum after 50 cycles at 150% rated current	
Mechanical		
Cord Accommodations	Round portable service cords of diameters in accordance with device rating as defined in UL62	
Cord Grip Accommodations	All 20 & 30A = .225"-1.150" diameter	
Terminal Identification	"GR" and Green Color = Ground, "WH" and White Color = Neutral, "X", "Y", "Z" = Hot	
Terminal Accommodation	#18 AWG min. - #8 AWG max.	
Product Identification	Amperage, Voltage, 3rd Party Compliance, NEMA Configuration hot stamped onto device	
Environmental		
Flammability	UL94 V2	
Operating Temperature	Maximum continuous: +75°C, Minimum: -40°C without impact	

INDUSTRIAL SPEC GRADE TURNLOK® LOCKING DEVICES

Receptacles Products Specifications & Performance

15, 20 & 30 Amp Turnlok Receptacles

RECEPTACLES	Standard Product	Corrosion-Resistant
Front Body	Nylon	Nylon
Back Body	Nylon	Nylon
Mounting Strap	15A = Steel; 20 & 30A = Brass	Nickel-Plated Brass
Pressure Plate	Brass	Nickel-Plated Brass
Contacts	Brass	Nickel-Plated Brass
Terminal Clamps	Brass	Nickel-Plated Brass
Terminal Screws	Brass	Brass
Mounting Screws	Zinc-Plated Steel	Stainless Steel
PERFORMANCE		
Electrical		
Dielectric Withstand Voltage	2000V minimum	
Maximum Working Voltage	600VAC	
Current Interrupting	Certified for current interrupting at full-rated current	
Temperature Rise	30°C maximum after 50 cycles at 150% rated current	
Mechanical		
Terminal Accommodation	15A = #18 AWG min. – #10 AWG max, 20 & 30A = #14 AWG min. – #10 AWG max.	
Product Identification	Amperage, Voltage, NEMA Configuration molded into face	
Environmental		
Flammability	UL94 V2	
Operating Temperature	Maximum continuous: +75°C, Minimum: -40°C without impact	

50 Amp Turnlok Receptacles

RECEPTACLES	Corrosion-Resistant	California Standard
Front Body	Glass-Filled Nylon	Glass-Filled Nylon
Back Body	Glass-Filled Nylon	Glass-Filled Nylon
Mounting Strap	Nickel-Plated Brass	Nickel-Plated Brass
Contacts	Nickel-Plated Brass	Brass
Terminal Clamps	Brass	Brass
Ground Shunt	Brass	Brass
Mounting Screws	Stainless Steel	Zinc-Plated Steel
PERFORMANCE		
Electrical		
Dielectric Withstand Voltage	3000V minimum	
Maximum Working Voltage	600VAC	
Current Interrupting	Certified for current interrupting at full-rated current	
Temperature Rise	30°C maximum after 50 cycles at 150% rated current	
Mechanical		
Terminal Accommodation	#10 AWG min. – #6 AWG max.	
Product Identification	Amperage, Voltage molded into face	
Environmental		
Flammability	UL94 V0	
Operating Temperature	Maximum continuous: +115°C, Minimum: -40°C without impact	

INDUSTRIAL SPEC GRADE TURNLOK[®] LOCKING DEVICES

Inlets & Outlets Product Specifications & Performance

15, 20 & 30 Amp Turnlok Inlets & Outlets

	15 Amp	20 Amp	30 Amp
FLANGED INLETS			
Flanged Casing	Polycarbonate	Polycarbonate	Polycarbonate
Blade Holder	Polycarbonate	Polycarbonate	Nylon
Blades	Nickel-Plated Brass	Brass	Tin-Plated Stresscon
Terminal Clamp	Zinc-Plated Steel	Zinc-Plated Steel	Brass
Terminal Screws	Zinc- or Brass-Plated Steel	Zinc- or Brass-Plated Steel	Brass
Ground Screws	Zinc-Plated Steel	Zinc-Plated Steel	Brass
Assembly Screws	Zinc-Plated Steel	Zinc-Plated Steel	Zinc-Plated Steel
FLANGED OUTLETS			
Flanged Casing	Polycarbonate	Polycarbonate	Polycarbonate
Contact Carrier	Polycarbonate	Polycarbonate	Nylon
Contacts	Brass	Brass	Tin-Plated Brass
Terminal Clamp	Zinc-Plated Steel	Zinc-Plated Steel	Brass- or Nickel-Plated Steel
Terminal Screws	Zinc- or Brass- Plated Steel	Zinc- or Brass-Plated Steel	Brass- or Nickel-Plated Steel
Ground Screws	Zinc-Plated Steel	Zinc-Plated Steel	Nickel-Plated Brass
Assembly Screws	Zinc-Plated Steel	Zinc-Plated Steel	Zinc-Plated Steel
PERFORMANCE			
Electrical			
Dielectric Withstand Voltage	15A = 2000V minimum, 20 & 30A = 3000V minimum		
Maximum Working Voltage	15A = 277VAC, 20 & 30A = 600VAC		
Current Interrupting	Certified for current interrupting at full-rated current		
Temperature Rise	30°C maximum after 50 cycles at 150% rated current		
Mechanical			
Terminal Identification	Green = Ground, White = Neutral, Brass = Hot		
Terminal Accommodation	15A = #18 AWG min.-#10 AWG max., 20 & 30A = #12 AWG min.- #8 AWG max.		
Product Identification	Amperage, Voltage, 3rd Party Compliance, NEMA Configuration		
Environmental			
Flammability	UL94 V2		
Operating Temperature	Maximum continuous: 15 & 20A = +115°C, 30A = +75°C, Minimum: -40°C without impact		

INDUSTRIAL SPEC GRADE TURNLOK[®] LOCKING DEVICES

Ground Continuity Monitoring Plugs & Connectors Product Specifications & Performance

15, 20 & 30 Amp Turnlok GCM Plugs & Connectors

PLUGS	
Back Body	Super Tough Nylon
Front Body	Nylon
Terminal Chamber	Polycarbonate
Cord Clamp	Nylon
Insert	Nylon
Dust Shield*	Neoprene
Blades	Brass
Terminal Clamp	15A = Zinc-Plated Steel, 20A = Nickel-Plated Steel, 30A = Brass
Terminal Screws	15A = Nickel- or Brass-Plated Steel, 20 & 30A = Brass
Ground Screws	15A = Nickel-Plated Steel, 20 & 30A = Brass
Cord Clamp Screws	Nickel-Plated Steel
Assembly Screws	Nickel-Plated Steel
CONNECTORS	
Back Body	Super Tough Nylon
Front Body	Nylon
Terminal Chamber	Polycarbonate
Cord Clamp	Nylon
Insert	Nylon
Dust Shield*	Neoprene
Contacts	Brass
Terminal Clamp	15A = Zinc-Plated Steel, 20A = Nickel-Plated Steel, 30A = Brass
Terminal Screws	15A = Nickel- or Brass-Plated Steel, 20 & 30A = Brass
Ground Screws	15A = Nickel-Plated Steel, 20 & 30A = Brass
Cord Clamp Screws	Nickel-Plated Steel
Assembly Screws	Nickel-Plated Steel
PERFORMANCE	
Electrical	
Dielectric Withstand Voltage	15A = 1600V minimum, 20 & 30A = 2200V minimum
Maximum Working Voltage	15A = 277VAC, 20 & 30A = 600VAC
Current Interrupting	Certified for current interrupting at full-rated current
Temperature Rise	30°C maximum after 50 cycles at 150% rated current
Mechanical	
Cord Accommodations	Round portable service cords of diameters in accordance with the device rating as defined in UL62
Cord Grip Accommodations	15A = .230"-.720" diameter, all 20 & 30A = .225"-1.150" diameter
Terminal Identification	15A = Green = Ground, White = Neutral, Brass = Hot, 20 & 30A = "GR" and Green Color = Ground, "WH" and White Color = Neutral, "X", "Y", "Z" = Hot
Terminal Accommodation	15A = #18 AWG min. - #10 AWG max, 20A = #18 AWG min. - #8 AWG max, 30A = #18 AWG min. - #6 AWG max.
Product Identification	Amperage, Voltage, 3rd Party Compliance, NEMA Configuration hot stamped onto device
Environmental	
Flammability	UL94 V2
Operating Temperature	Maximum continuous: +75°C, Minimum: -40°C without impact

*Dust Shield for 20 & 30 Amp Plugs & Connectors.

INDUSTRIAL SPEC GRADE TURNLOK® LOCKING DEVICES

Plugs & Connectors Product Specifications & Performance

50 Amp Turnlok Plugs & Connectors

PLUGS	Corrosion-Resistant	California Standard
Plug Shroud	Zytel Super Tough Nylon	Zytel Super Tough Nylon
Back Body	Nylon	Nylon
Front Body	Nylon	Nylon
Terminal Chamber	Nylon	Nylon
Cord Clamp	Nylon	Nylon
Blades	Nickel-Plated Brass	Brass
Terminal Clamp	Nickel-Plated Brass	Brass
Terminal Screws	Nickel-Plated Brass	Brass
Ground Screw	Nickel-Plated Brass	Brass
Assembly Screws	Stainless Steel	Stainless Steel
CONNECTORS		
Back Body	Nylon	Nylon
Front Body	Nylon	Nylon
Terminal Chamber	Nylon	Nylon
Cord Clamp	Nylon	Nylon
Contacts	Nickel-Plated Brass	Brass
Terminal Clamp	Nickel-Plated Brass	Brass
Terminal Screws	Nickel-Plated Brass	Brass
Ground Screw	Nickel-Plated Brass	Brass
Assembly Screws	Stainless Steel	Stainless Steel
PERFORMANCE		
Electrical		
Dielectric Withstand Voltage	3000V minimum	
Maximum Working Voltage	600VAC	
Current Interrupting	Certified for current interrupting at full-rated current	
Temperature Rise	30°C maximum after 50 cycles at 150% rated current	
Mechanical		
Cord Accommodations	Round portable service cords of diameters in accordance with the device rating as defined in UL62	
Cord Grip Accommodations	.680"–1.125" diameter	
Terminal Identification	Color Coded Terminal Screws	
Terminal Accommodation	#10 AWG min. – #4 AWG max.	
Product Identification	Amperage, Voltage hot stamped on device	
Environmental		
Flammability	UL94 HB or better	
Operating Temperature	Maximum continuous: +75°C, Minimum: -40°C without impact	

INDUSTRIAL SPEC GRADE TURNLOK[®] LOCKING DEVICES

Inlets Product Specifications & Performance & Horsepower Rating Chart

50 Amp Inlet

INLETS	
Flanged Casing	Nylon
Contact Carrier	Nylon
Blades	Brass
Terminal Clamps	Brass
Terminal Screws	Brass
Assembly Screws	Nickel-Plated Steel
PERFORMANCE	
Electrical	
Dielectric Withstand Voltage	3000V minimum
Maximum Working Voltage	600VAC
Current Interrupting	Certified for current interrupting at full-rated current
Temperature Rise	30°C maximum after 50 cycles at 150% rated current
MECHANICAL	
Terminal Accommodation	#10 AWG min. – #4 AWG max.
Product Identification	Amperage, Voltage hot stamped onto face
ENVIRONMENTAL	
Flammability	UL94 V0
Operating Temperature	Maximum continuous: +75°C, Minimum: -40°C without impact

Turnlok Horsepower Rating for NEMA Configuration Attachment Plugs & Receptacles



NEMA Configuration	AC HP Rating	NEMA Configuration	AC HP Rating
L1-15	1/2	L21-20	2
L5-15	1/2	L22-20	5
L6-15	1 1/2*	L5-30	2
L7-15	2	L6-30	2*
L2-20	2*	L7-30	3
L5-20	1	L8-30	5
L6-20	2*	L10-30	2 Line to Line*
L7-20	2		2 Line to Neutral
L8-20	3	L11-30	3
L10-20	2 Line to Line*	L12-30	10
	1 Line to Neutral	L14-30	2 Line to Line*
L11-20	3	L15-30	3
L12-20	5	L16-30	10
L14-20	2 Line to Line*	L18-30	3
L15-20	3	L19-30	10
L16-20	5	L21-30	3
L18-20	2	L22-30	10
L19-20	5		

*Suitable for 208V motor applications at the HP rating specified.

CAM-TYPE DEVICES



Pass & S Cam-Type Devices are built with top-quality materials for enhanced durability and service life, with increased insulation protection for safety.

Featured Products	 SERIES 16 PROTECTIVE CAPS AND ADAPTERS 1-8	 SERIES 16 FLIP LID COVERS 1-9	 45° ANGLED RECEPTACLES 1-7
--------------------------	--	--	--

Series 15 In-Line Connectors, Protective Caps & Adapters	1-3
Series 15 Panel Mounts & Accessories	1-4
Series 16 In-Line Connectors	1-2, 1-5
Series 16 Panel Mounts	1-6
45° Angled Receptacles	1-7

Series 16 Protective Caps & Adapters	1-8
Series 16 Flip Lid Covers	1-9
Series 16 Accessories	1-10
Series 18 In-Line Connectors	1-11
Dimensional Drawings	1-12

CAM-TYPE DEVICES

Series 16 In-Line Connectors

- A. Thermoplastic elastomer housing** is chemical- and impact-resistant.
 - B. Non-conductive retaining screw** insures stability of the fully assembled product.
 - C. Heavy-duty brass contacts** provide superior and consistent conductivity.
- Rounded back contour** reduces snags and hang-ups on the job site.
- Impact- and corrosion-resistant** durable nylon 6/6 shell material.



Heavy-duty hex set screws allow greater termination torque.



Copper shim bundles wire strands to reduce "splaying."

Copper wire provides superior strain relief.

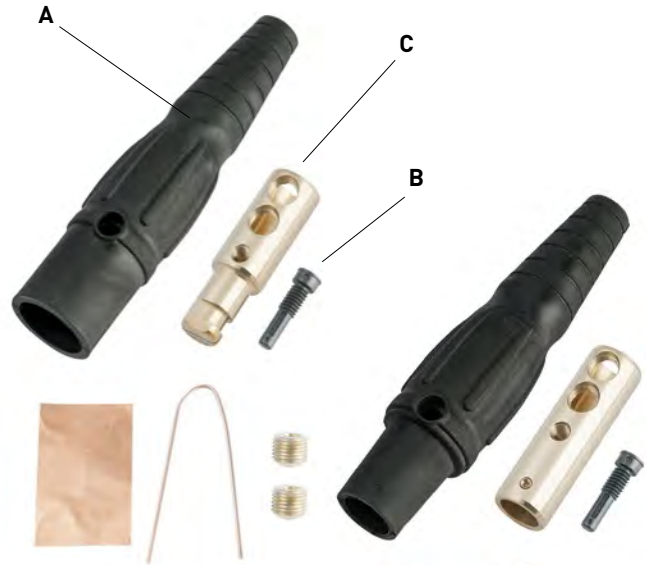

PS40MBBK
(unassembled)



PS45FRBBK
(unassembled)



PS45MRBBK



PS45FRBBK

- **45° Angled Version** is perfect for applications where cables protruding 90° from the panel is impractical.
- Solid one-piece brass contacts provide superior and consistent connection under the most extreme conditions.
- Intermateable and compatible with competitive cam-type products.

CAM-TYPE DEVICES

Series 15 In-Line Connectors, Protective Caps & Adapters



Features

- Thermoplastic elastomer housing for outstanding impact and chemical resistance, as well as an exceptional seal for maintaining NEMA Type 3R and 4 integrity.
- Non-conductive retaining screw helps to insure no contact with live parts, along with providing stability to the fully assembled product.
- Heavy-duty brass male and female contacts provide a superior and consistent means of conductivity.
- Heavy-duty hex set screws allow greater termination torque.
- Copper wire provides quality strain relief.
- Copper shim bundles wire strands to reduce "splaying."

CATALOG NUMBER	RATING		CABLE SIZE	COLOR	3rd PARTY COMPLIANCE	
	A.	V.			UL	cCSAus
SERIES 15 IN-LINE CONNECTORS – MALE						
PSM2MBK	150	600	#8 – #2	Black	•	•
PSM2MW	150	600	#8 – #2	White	•	•
PSM2MR	150	600	#8 – #2	Red	•	•
PSM2MBL	150	600	#8 – #2	Blue	•	•
PSM2MG	150	600	#8 – #2	Green	•	•
SERIES 15 IN-LINE CONNECTORS – FEMALE						
PSM2FBK	150	600	#8 – #2	Black	•	•
PSM2FW	150	600	#8 – #2	White	•	•
PSM2FR	150	600	#8 – #2	Red	•	•
PSM2FBL	150	600	#8 – #2	Blue	•	•
PSM2FG	150	600	#8 – #2	Green	•	•

CATALOG NUMBER	COLOR
SERIES 15 PROTECTIVE CAPS – MALE	
PSMFCBK	Black
SERIES 15 PROTECTIVE CAPS – FEMALE	
PSMFCBK	Black

Other colors available, please contact factory.

CATALOG NUMBER	RATING	COLOR
SERIES 15 ADAPTERS – CAM REDUCERS		
PSMADMFBK	400A M – 150A F	Black
PSMADMFW	400A M – 150A F	White
PSMADMFR	400A M – 150A F	Red
PSMADMFBL	400A M – 150A F	Blue
PSMADMFG	400A M – 150A F	Green
PSMADFMBK	400A F – 150A M	Black
PSMADFMW	400A F – 150A M	White
PSMADFMR	400A F – 150A M	Red
PSMADFMBL	400A F – 150A M	Blue
PSMADFMG	400A F – 150A M	Green

CAM-TYPE DEVICES

Series 15 Panel Mounts & Accessories

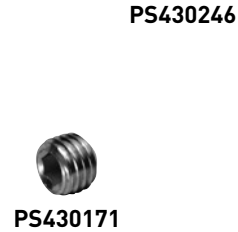

*For double set screw, dimension is 1.000".

Features

- Nylon housing provides outstanding impact and chemical resistance.
- Heavy-duty brass male and female contacts provide a superior and consistent means of conductivity.
- Heavy-duty hex set screws (available on double set screw version only) allow greater termination torque.

CATALOG NUMBER	RATING		CABLE SIZE	COLOR	3rd PARTY COMPLIANCE	
	A.	V.			UL	cCSAus
SERIES 15 THREADED STUD PANEL MOUNTS – MALE						
PSMMR5BK	150	600	#8 – #2	Black	•	•
PSMMR5W	150	600	#8 – #2	White	•	•
PSMMR5R	150	600	#8 – #2	Red	•	•
PSMMR5BL	150	600	#8 – #2	Blue	•	•
PSMMR5G	150	600	#8 – #2	Green	•	•
SERIES 15 THREADED STUD PANEL MOUNTS – FEMALE						
PSMFR5BK	150	600	#8 – #2	Black	•	•
PSMFR5W	150	600	#8 – #2	White	•	•
PSMFR5R	150	600	#8 – #2	Red	•	•
PSMFR5BL	150	600	#8 – #2	Blue	•	•
PSMFR5G	150	600	#8 – #2	Green	•	•
SERIES 15 DOUBLE SET SCREW PANEL MOUNTS – MALE						
PSMMR6BK	150	600	#8 – #2	Black	•	•
PSMMR6W	150	600	#8 – #2	White	•	•
PSMMR6R	150	600	#8 – #2	Red	•	•
PSMMR6BL	150	600	#8 – #2	Blue	•	•
PSMMR6G	150	600	#8 – #2	Green	•	•
SERIES 15 DOUBLE SET SCREW PANEL MOUNTS – FEMALE						
PSMFR6BK	150	600	#8 – #2	Black	•	•
PSMFR6W	150	600	#8 – #2	White	•	•
PSMFR6R	150	600	#8 – #2	Red	•	•
PSMFR6BL	150	600	#8 – #2	Blue	•	•
PSMFR6G	150	600	#8 – #2	Green	•	•

CATALOG NUMBER	DESCRIPTION
SERIES 15 ACCESSORIES	
PS430246	Series 15 Strain Relief Wire
PS430244	Copper Shim
PS430171	Series 15 Set Screw

CAM-TYPE DEVICES

Series 16 In-Line Connectors

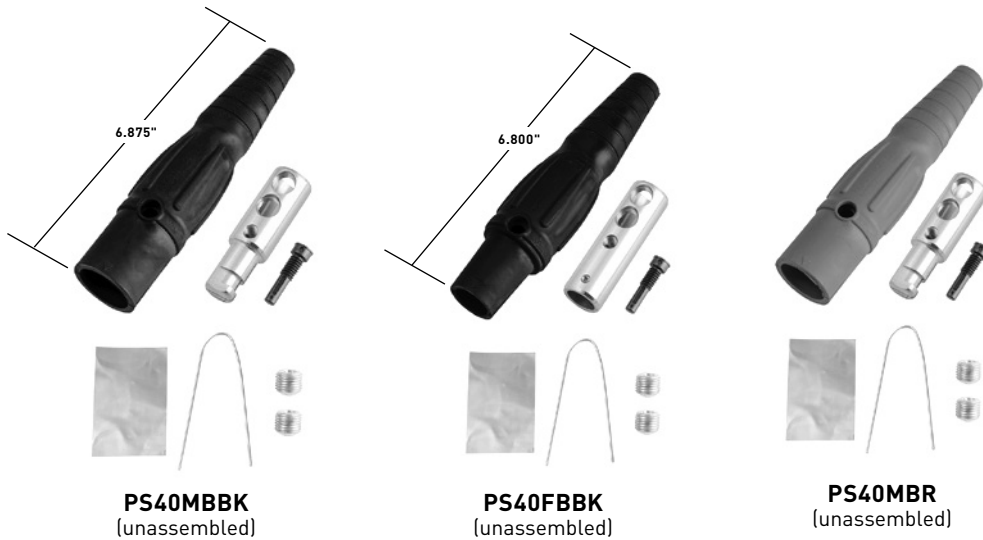

Features

- Thermoplastic elastomer housing for outstanding impact and chemical resistance, as well as an exceptional seal for maintaining NEMA Type 3R and 4 integrity.
- Non-conductive retaining screw helps to insure no contact with live parts, along with providing stability to the fully assembled product.
- Heavy-duty brass male and female contacts provide a superior and consistent means of conductivity.
- Heavy-duty hex set screws allow greater termination torque.
- Copper wire provides quality strain relief.
- Copper shim bundles wire strands to reduce “splaying.”

CATALOG NUMBER	RATING*		CABLE SIZE	COLOR	3rd PARTY COMPLIANCE	
	A.	V.			UL	cCSAus
SERIES 16 IN-LINE CONNECTORS – MALE						
PS20MBBK	400	600	#2 - 2/0	Black	•	•
PS20MBW	400	600	#2 - 2/0	White	•	•
PS20MBR	400	600	#2 - 2/0	Red	•	•
PS20MBBL	400	600	#2 - 2/0	Blue	•	•
PS20MBG	400	600	#2 - 2/0	Green	•	•
PS20MBBR	400	600	#2 - 2/0	Brown	•	•
PS20MBO	400	600	#2 - 2/0	Orange	•	•
PS20MBY	400	600	#2 - 2/0	Yellow	•	•
PS40MBBK	400	600	2/0 - 4/0	Black	•	•
PS40MBW	400	600	2/0 - 4/0	White	•	•
PS40MBR	400	600	2/0 - 4/0	Red	•	•
PS40MBBL	400	600	2/0 - 4/0	Blue	•	•
PS40MBG	400	600	2/0 - 4/0	Green	•	•
PS40MBBR	400	600	2/0 - 4/0	Brown	•	•
PS40MBO	400	600	2/0 - 4/0	Orange	•	•
PS40MBY	400	600	2/0 - 4/0	Yellow	•	•

CATALOG NUMBER	RATING*		CABLE SIZE	COLOR	3rd PARTY COMPLIANCE	
	A.	V.			cULUS	cCSAus
SERIES 16 IN-LINE CONNECTORS – FEMALE						
PS20FBBK	400	600	#2 - 2/0	Black	•	•
PS20FBW	400	600	#2 - 2/0	White	•	•
PS20FBR	400	600	#2 - 2/0	Red	•	•
PS20FBBL	400	600	#2 - 2/0	Blue	•	•
PS20FBG	400	600	#2 - 2/0	Green	•	•
PS20FBBR	400	600	#2 - 2/0	Brown	•	•
PS20FBO	400	600	#2 - 2/0	Orange	•	•
PS20FBY	400	600	#2 - 2/0	Yellow	•	•
PS40FBBK	400	600	2/0 - 4/0	Black	•	•
PS40FBW	400	600	2/0 - 4/0	White	•	•
PS40FBR	400	600	2/0 - 4/0	Red	•	•
PS40FBBL	400	600	2/0 - 4/0	Blue	•	•
PS40FBG	400	600	2/0 - 4/0	Green	•	•
PS40FBBR	400	600	2/0 - 4/0	Brown	•	•
PS40FBO	400	600	2/0 - 4/0	Orange	•	•
PS40FBY	400	600	2/0 - 4/0	Yellow	•	•

*All ratings both AC/DC.

CAM-TYPE DEVICES

Series 16 Panel Mounts



PS40MRSBBK



PS40FRSBBK



PS40MRBBK

PS40FRBBK

Features

- Nylon housing provides outstanding impact and chemical resistance.
- Heavy-duty brass male and female contacts provide a superior and consistent means of conductivity.
- Heavy-duty hex set screws (available on double set screw version only) allow greater termination torque.

CATALOG NUMBER	RATING*		CABLE SIZE	COLOR	3rd PARTY COMPLIANCE	
	A.	V.			UL	cUL
SERIES 16 THREADED STUD PANEL MOUNTS – MALE						
PS40MRSBBK	400	600	#2 - 4/0	Black	•	•
PS40MRSBW	400	600	#2 - 4/0	White	•	•
PS40MRSBR	400	600	#2 - 4/0	Red	•	•
PS40MRSBBL	400	600	#2 - 4/0	Blue	•	•
PS40MRSBG	400	600	#2 - 4/0	Green	•	•
PS40MRSBO	400	600	#2 - 4/0	Orange	•	•
PS40MRSBY	400	600	#2 - 4/0	Yellow	•	•
SERIES 16 THREADED STUD PANEL MOUNTS – FEMALE						
PS40FRSBBK	400	600	#2 - 4/0	Black	•	•
PS40FRSBW	400	600	#2 - 4/0	White	•	•
PS40FRSBR	400	600	#2 - 4/0	Red	•	•
PS40FRSBBL	400	600	#2 - 4/0	Blue	•	•
PS40FRSBG	400	600	#2 - 4/0	Green	•	•
PS40FRSBBR	400	600	#2 - 4/0	Brown	•	•
PS40FRSBO	400	600	#2 - 4/0	Orange	•	•
PS40FRSBY	400	600	#2 - 4/0	Yellow	•	•

CATALOG NUMBER	RATING*		CABLE SIZE	COLOR	3rd PARTY COMPLIANCE	
	A.	V.			UL	cUL
SERIES 16 DOUBLE SET SCREW PANEL MOUNTS – MALE						
PS40MRBBK	400	600	2/0 - 4/0	Black	•	•
PS40MRBW	400	600	2/0 - 4/0	White	•	•
PS40MRBR	400	600	2/0 - 4/0	Red	•	•
PS40MRBBL	400	600	2/0 - 4/0	Blue	•	•
PS40MRBG	400	600	2/0 - 4/0	Green	•	•
PS40MRBBR	400	600	2/0 - 4/0	Brown	•	•
PS40MRBO	400	600	2/0 - 4/0	Orange	•	•
PS40MRBY	400	600	2/0 - 4/0	Yellow	•	•
SERIES 16 DOUBLE SET SCREW PANEL MOUNTS – FEMALE						
PS40FRBBK	400	600	2/0 - 4/0	Black	•	•
PS40FRBW	400	600	2/0 - 4/0	White	•	•
PS40FRBR	400	600	2/0 - 4/0	Red	•	•
PS40FRBBL	400	600	2/0 - 4/0	Blue	•	•
PS40FRBG	400	600	2/0 - 4/0	Green	•	•
PS40FRBBR	400	600	2/0 - 4/0	Brown	•	•
PS40FRBO	400	600	2/0 - 4/0	Orange	•	•
PS40FRBY	400	600	2/0 - 4/0	Yellow	•	•

*All ratings both AC/DC.

CAM-TYPE DEVICES

45° Angled Receptacles



PS45MRBBK



PS45FRBBK

Features

- Type 3R Rated for Indoor and Outdoor use.
- Solid one-piece brass contacts provide superior and consistent connection under the most extreme conditions.
- Housing is made of Santoprene for outstanding impact and chemical resistance.
- Heavy-duty hex set screws (available on double set version only) allow greater termination torque.
- Brass eyelets for #10-32 mounting through bolts (bolts not provided).

CATALOG NUMBER	RATING*		CABLE SIZE	COLOR	3rd PARTY COMPLIANCE	
	A.	V.			UL 498 UL 1682	CSA 22.2 No. 65-93 CSA 22.2 No. 94-M91 CSA 22.2 No. 182-1988
SERIES 16 45° 1 1/8" THREADED STUD PANEL MOUNT - MALE						
PS45MRSBBK	400	600	2/0 - 4/0	Black	•	•
PS45MRSBW	400	600	2/0 - 4/0	White	•	•
PS45MRSBR	400	600	2/0 - 4/0	Red	•	•
PS45MRSBBL	400	600	2/0 - 4/0	Blue	•	•
PS45MRSBG	400	600	2/0 - 4/0	Green	•	•
SERIES 16 45° 2" THREADED STUD PANEL MOUNT - MALE						
PS45MR2SBBK	400	600	2/0 - 4/0	Black	•	•
PS45MR2SBW	400	600	2/0 - 4/0	White	•	•
PS45MR2SBR	400	600	2/0 - 4/0	Red	•	•
PS45MR2SBBL	400	600	2/0 - 4/0	Blue	•	•
PS45MR2SBG	400	600	2/0 - 4/0	Green	•	•
SERIES 16 45° 1 1/8" THREADED STUD PANEL MOUNT - FEMALE						
PS45FRSBBK	400	600	2/0 - 4/0	Black	•	•
PS45FRSBW	400	600	2/0 - 4/0	White	•	•
PS45FRSBR	400	600	2/0 - 4/0	Red	•	•
PS45FRSBBL	400	600	2/0 - 4/0	Blue	•	•
PS45FRSBG	400	600	2/0 - 4/0	Green	•	•
SERIES 16 45° 2" THREADED STUD PANEL MOUNT - FEMALE						
PS45FR2SBBK	400	600	2/0 - 4/0	Black	•	•
PS45FR2SBW	400	600	2/0 - 4/0	White	•	•
PS45FR2SBR	400	600	2/0 - 4/0	Red	•	•
PS45FR2SBBL	400	600	2/0 - 4/0	Blue	•	•
PS45FR2SBG	400	600	2/0 - 4/0	Green	•	•
SERIES 16 45° DOUBLE SET SCREW PANEL MOUNT - MALE						
PS45MRBBK	400	600	2/0 - 4/0	Black	•	•
PS45MRBW	400	600	2/0 - 4/0	White	•	•
PS45MRBR	400	600	2/0 - 4/0	Red	•	•
PS45MRBBL	400	600	2/0 - 4/0	Blue	•	•
PS45MRBG	400	600	2/0 - 4/0	Green	•	•
SERIES 16 45° DOUBLE SET SCREW PANEL MOUNT - FEMALE						
PS45FRBBK	400	600	2/0 - 4/0	Black	•	•
PS45FRBW	400	600	2/0 - 4/0	White	•	•
PS45FRBR	400	600	2/0 - 4/0	Red	•	•
PS45FRBBL	400	600	2/0 - 4/0	Blue	•	•
PS45FRBG	400	600	2/0 - 4/0	Green	•	•

All devices listed on this page conform to NEMA WD-1 and WD-6.

CAM-TYPE DEVICES

Series 16 Protective Caps & Adapters

PS40FCBK

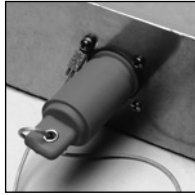

PS40MCBK

PSPTBK



PSSTBK

PS3MG



PS3FBK

PSMMBK



PSFFCBK

CATALOG NUMBER	COLOR	3rd PARTY COMPLIANCE  cCSAus
SERIES 16 M-F-F TAPPING "T" ADAPTERS		
PSTTBK	Black	•
PSTTW	White	•
PSSTR	Red	•
PSSTBL	Blue	•
PSSTG	Green	•
PSSTBR	Brown	•
PSSTY	Yellow	•
SERIES 16 M-M-F PARALLELING "T" ADAPTERS		
PSPTBK	Black	•
PSPTBR	Brown	•
PSPTO	Orange	•
PSPTY	Yellow	•
SERIES 16 F-M-M-M 3FER ADAPTERS		
PS3MW	White	
PS3MG	Green	
SERIES 16 M-F-F-F 3FER ADAPTERS		
PS3FBK	Black	•
PS3FW	White	•
PS3FR	Red	•
PS3FBL	Blue	•
PS3FG	Green	•
PS3FBR	Brown	•
PS3FO	Orange	•
PS3FY	Yellow	•
SERIES 16 MALE-TO-MALE COUPLER		
PSMMBK	Black	•
PSMMW	White	•
PSMMR	Red	•
PSMMBL	Blue	•
PSMMG	Green	•
SERIES 16 FEMALE-TO-FEMALE COUPLER		
PSFFCBK	Black	•
PSFFCW	White	•
PSFFCR	Red	•
PSFFCBL	Blue	•
PSFFCG	Green	•

CATALOG NUMBER	COLOR
SERIES 16 PROTECTIVE CAPS - MALE	
PS40MCBK	Black
PS40MCW	White
PS40MCR	Red
PS40MCBL	Blue
PS40MCG	Green
PS40MCBR	Brown
PS40MCO	Orange
PS40MCY	Yellow

CATALOG NUMBER	COLOR
SERIES 16 PROTECTIVE CAPS - FEMALE	
PS40FCBK	Black
PS40FCW	White
PS40FCR	Red
PS40FCBL	Blue
PS40FCG	Green
PS40FCBR	Brown
PS40FCO	Orange
PS40FCY	Yellow

CAM-TYPE DEVICES

Series 16 Flip Lid Covers

Description

Manufactured in UV-resistant polycarbonate, all snap back plastic covers are made with stainless steel offset, spring and pin. Designed for surface mount or internal mount, the new snap back plastic covers are fully gasketed and NEMA 3R rated for weathertight protection.

CATALOG NUMBER	COLOR
PLASTIC FLIP LID, THROUGH-MOUNT FOR .070-.090 WALL THICKNESS	
PS40WTCLBK	Black
PS40WTCLW	White
PS40WTCLR	Red
PS40WTCLBL	Blue
PS40WTCLG	Green
PS40WTCLBR	Brown
PS40WTCLO	Orange
PS40WTCLY	Yellow
PLASTIC FLIP LID, THROUGH-MOUNT FOR .370-.400 WALL THICKNESS	
PS40WTCSBK	Black
PS40WTCSW	White
PS40WTCSR	Red
PS40WTCSBL	Blue
PS40WTCSG	Green
PS40WTCSBR	Brown
PS40WTCSO	Orange
PS40WTCSY	Yellow
PANEL-MOUNT NEMA 3R NON-METALLIC FLIP-LID COVERS	
PS40CLL3RBK	Black
PS40CLL3RBL	Blue
PS40CLL3RG	Green
PS40CLL3RBR	Brown
PS40CLL3RR	Red
PS40CLL3RO	Orange
PS40CLL3RW	White
PS40CLL3RY	Yellow
PS40CLL3RCL	Clear

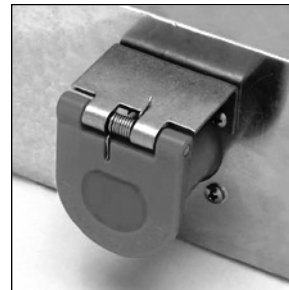

PS40WTCL



PS40CLL3R

CAM-TYPE DEVICES

Series 16 Accessories



PS430245

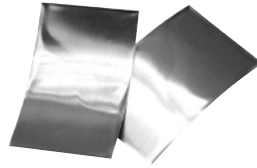

PS430244



PS520710



PS16CLM

PS16CLF

CATALOG NUMBER	DESCRIPTION
SERIES 16 ACCESSORIES	
PS430245	Series 16 Strain Relief Wire
PS430244	Copper Shim
PS520710	Series 16 Retaining Screw
PS16CLM	Male Connector Extractor
PS16CLF	Female Connector Extractor

CAM-TYPE DEVICES

Series 18 In-Line Connectors Weatherproof

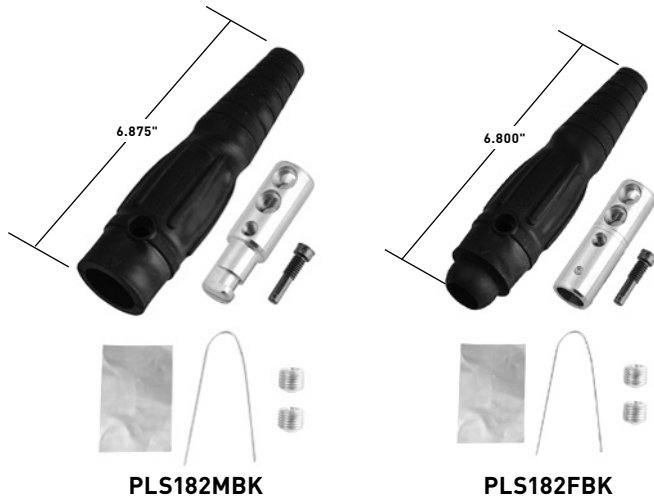

CATALOG NUMBER	RATING*		CABLE SIZE	COLOR	3rd PARTY COMPLIANCE		
	A.	V.			UL	cUL	cCSAus
SERIES 18 IN-LINE CONNECTORS – MALE							
PLS182MBK	400	600	#6 – #2	Black	•	•	•
PLS182MW	400	600	#6 – #2	White	•	•	•
PLS182MR	400	600	#6 – #2	Red	•	•	•
PLS182MBL	400	600	#6 – #2	Blue	•	•	•
PLS182MG	400	600	#6 – #2	Green	•	•	•
PLS1820MBK	400	600	#2 – 2/0	Black	•	•	•
PLS1820MW	400	600	#2 – 2/0	White	•	•	•
PLS1820MR	400	600	#2 – 2/0	Red	•	•	•
PLS1820MBL	400	600	#2 – 2/0	Blue	•	•	•
PLS1820MG	400	600	#2 – 2/0	Green	•	•	•
PLS1840MBK	400	600	4/0	Black	•	•	•
PLS1840MBL	400	600	4/0	Blue	•	•	•
SERIES 18 IN-LINE CONNECTORS – FEMALE							
PLS182FBK	400	600	#6 – #2	Black	•	•	•
PLS182FW	400	600	#6 – #2	White	•	•	•
PLS182FR	400	600	#6 – #2	Red	•	•	•
PLS182FBL	400	600	#6 – #2	Blue	•	•	•
PLS182FG	400	600	#6 – #2	Green	•	•	•
PLS1820FBK	400	600	#2 – 2/0	Black	•	•	•
PLS1820FW	400	600	#2 – 2/0	White	•	•	•
PLS1820FR	400	600	#2 – 2/0	Red	•	•	•
PLS1820FBL	400	600	#2 – 2/0	Blue	•	•	•
PLS1820FG	400	600	#2 – 2/0	Green	•	•	•
PLS1840FBK	400	600	4/0	Black	•	•	•
PLS1840FBL	400	600	4/0	Blue	•	•	•

*All ratings both AC/DC.

Features

- Interchangeable with Canadian CAM devices from other manufacturers.
- Ball nose design achieves NEMA 3R,4 rating.
- Designed specifically for Sea Way cable.
- Accepts #6 through 4/0 size wire.
- Double set screws for premium wire retention.
- Locking screw prevents contact from rotating inside housing.

Series 16 Inline Connectors

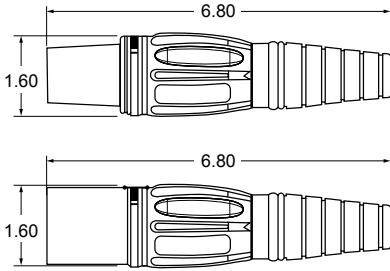

PS20MB, PS20FB
PS40MB, PS40FB

Series 18 Inline Connectors

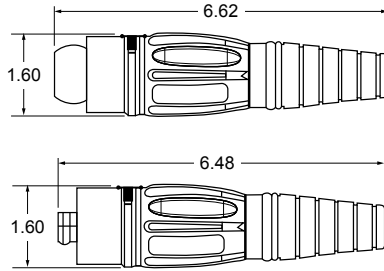

PLS182M, PLS182F
PLS1820M, PLS1820F
PLS1840M, PLS1840F

Series 15 Inline Connectors

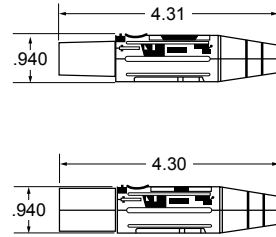

PSM2M, PSM2F

Series 16 Panel Mounts

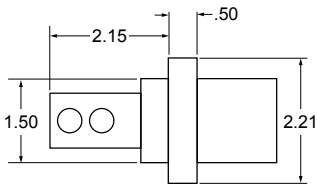

PS40MRB, PS40FRB

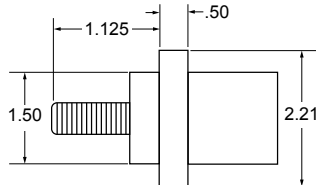

PS40MRSB, PS40FRSB

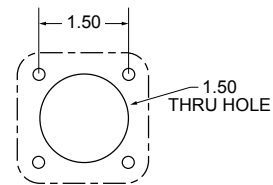

Series 16 Panel Mount
Family Cut-out

Series 15 Panel Mounts

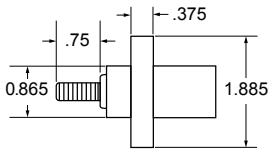

PSMMRS, PSMFRS

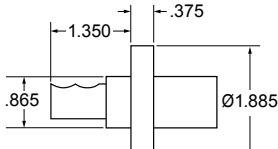

PSMMR, PSMFR

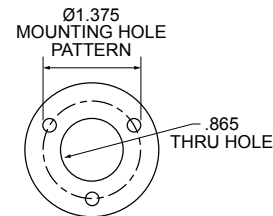

Series 15 Panel Mount
Family Cut-out

Series 16 45 Degree Panel Mounts

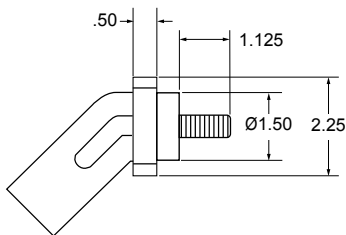

PS45MRS, PS45FRS

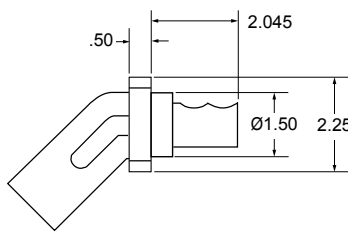

PS45MRB, PS45FRB

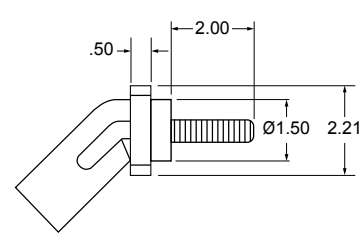

PS45MR2S, PS45FR2S

IEC 309 INDUSTRIAL PRODUCTS



Our durable, high-performance IEC 309 Industrial Products solutions have a unifying principle: Just because a device has to endure difficult conditions doesn't mean it has to be difficult to wire and use.

Installers asked for quick, no-guesswork wiring... Plant and MRO staff asked for maximum durability and minimum downtime... And everyone wanted better selection to meet today's demanding requirements without compromise. Now take a close look at our answers: Fusible Mechanical Interlocks that cut downtime, thanks to the first-ever visible blown-fuse indication. Fusible Safety Switches with the same innovative blown-fuse-indicating LEDs. And capacities in P&S Non-Fusible Interlocks and Safety Switches.

Add proven feature-rich P&S Pin & Sleeve devices, and the result is a problem-solving IEC 309-1 and -2 product family. It's ready to work for you anywhere — because P&S IEC 309 products are guaranteed to be interchangeable with all IEC 309-1 and -2 devices, and because more than 50 countries are IEC participants, including all the world's major trading nations. As a result, manufacturers can easily standardize their electrical component specifications worldwide, simplifying purchasing, training and application to reduce costs.

P&S IEC products work for you, helping you multiply those savings — thanks to uncompromising materials and construction that deliver long-term dependability.

Take a closer look at the complete P&S IEC 309 industrial family. Compare construction, features, and specifications. Add the support of a global company, ready to help you succeed no matter where you do business. And see why this is the selection that works for you.

Featured Products



P17 TEMPTRA PRO

J-32

Configuration	J-2
Clocking System	J-3
Fusible Mechanical Interlocks	J-4
Non-Fusible Mechanical Interlocks	J-9
Pin & Sleeve Devices	J-14

Pin & Sleeve Devices Dimensional Information & Technical Specifications	J-25
Product Selection Guide	J-29
P17 Temptra	J-32

STRAIGHT BLADE PLUGS & CONNECTORS

Adapting To Worldwide Configuration Standards

Application

Pass & Seymour® Pin & Sleeve products are designed to meet IEC 309-1, 309-2 specifications. These specifications are recognized around the world and are intended to prevent the mating of plugs and receptacles of different voltage and current ratings (see Section 406.3(F) of the National Electrical Code® relating to this noninterchangeability feature).

Global Product Offering

Legrand provides Pass & Seymour® IEC 309-1, 309-2 Pin & Sleeve products in both Series I (International) and Series II (North American) current ratings:

- Series I (International) 16, 32, 63, 125 Amps
- Series II (North American) 20, 30, 60, 100 Amps

North American Catalog Numbering System

Catalog numbers within the North American product offering are structured to communicate the following: manufacturer, number of conductors, amperage rating, device type, clocking position of the ground sleeve, and environmental rating. This applies to all receptacles, inlets, plugs, and connectors in the Legrand North American Pass & Seymour® Pin & Sleeve product line (see sample at right).

Here's How It Works

The amperage rating is determined by the size of the device. Voltage rating is determined by the location of the ground sleeve on the receptacle and/or connector along with the number of conductors.

Ground sleeve position for all connectors and receptacles is based on a clock face with the keyway always being at 6 o'clock. The ground sleeve is positioned at a specific hour point, depending on the device's voltage rating.

The clocking position for plugs and inlets is a mirror image of the mating device, allowing for interconnection.

In addition, voltage ratings for all Pin & Sleeve products are color coded for visual identification.

IEC 309 INDUSTRIAL PRODUCTS

Clocking System

IEC 309 Clocking System North American Catalog Numbering System

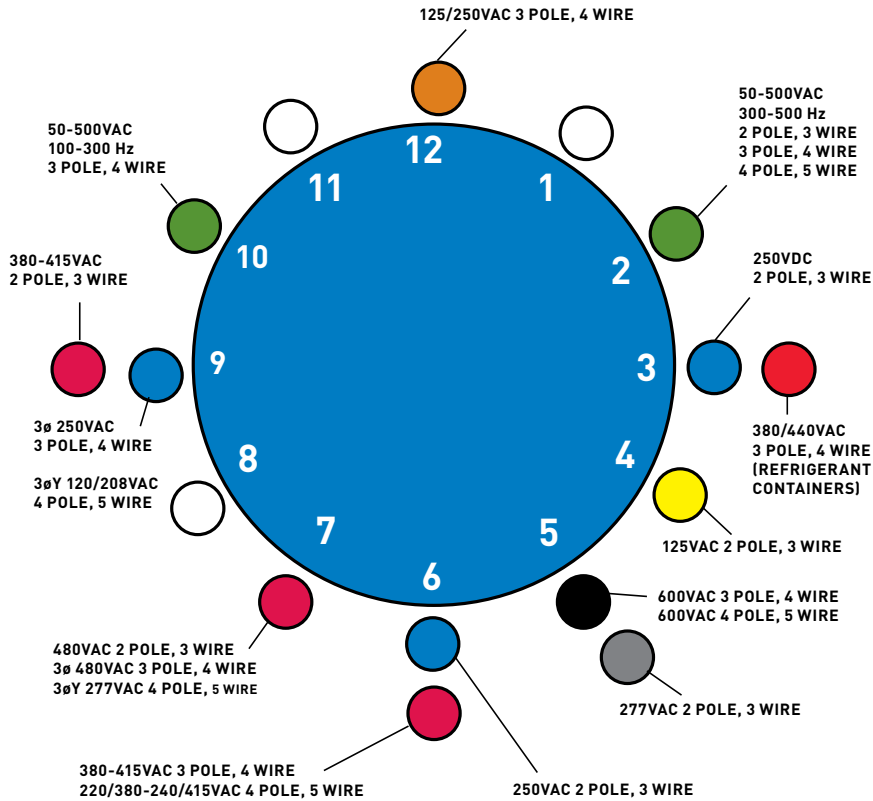

Application Specific

North American Catalog Numbering System

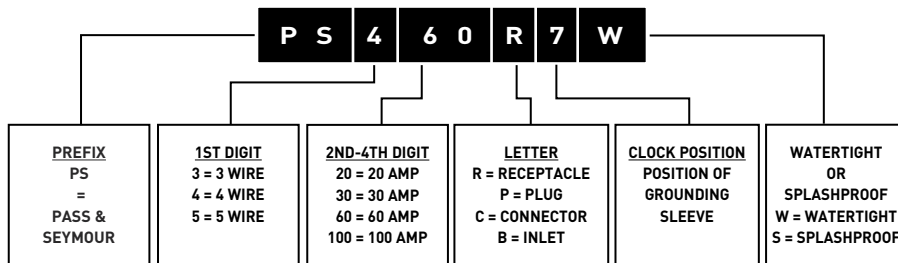

SWITCH DISCONNECTS & MANUAL MOTOR CONTROLLERS

Fusible Mechanical Interlock



See everything you're looking for in a Fusible Mechanical Interlock. Even if it's a blown fuse.

Introducing the first interlocks to include visible blown-fuse indication, a hinged, easy-access fuse door, and integral fuse pullers. At last, you can easily locate and replace a blown fuse in less than a minute.

Of course, saving time isn't your only challenge. You face dirt and dust. Corrosive liquids or vapors. Water or high humidity. Heat. Vibration. And impacts. No wonder ensuring safe, dependable, locally fused power to portable industrial equipment can be tough! But now, these unique P&S Fusible Mechanical Interlocks bring you a better solution.

Here's the extra-rugged construction to stand up to the toughest plant environments. Complete IEC 309 interchangeability. And an easy-installing design that fits into most I-beams. Choose these 20 to 100 amp NEMA 4X and 12 watertight-rated Fusible Mechanical Interlocks for your most demanding applications — and Legrand's Pass & Seymour® devices are "designed to be better."

SWITCH DISCONNECTS & MANUAL MOTOR CONTROLLERS

Fusible Mechanical Interlock

Fusible Mechanical Interlock Operating Sequence

1. When there is no plug in the device, the lock tab is in the "off" position and prevents the lock gear from turning. The handle cannot be moved to the "on" position.
2. Upon inserting a plug, the lock tab moves from the "off" position, freeing the lock gear.
3. The handle can then be moved to the "on" position. This rotates the lock gear and engages the key on the plug to prevent it from being removed. At the same time, the rack is actuated and rotates the switch gear, turning on the switch and inducing power.
4. Returning the handle to the "off" position frees the lock gear, disengaging the plug key from the switch and allowing the plug to be removed.

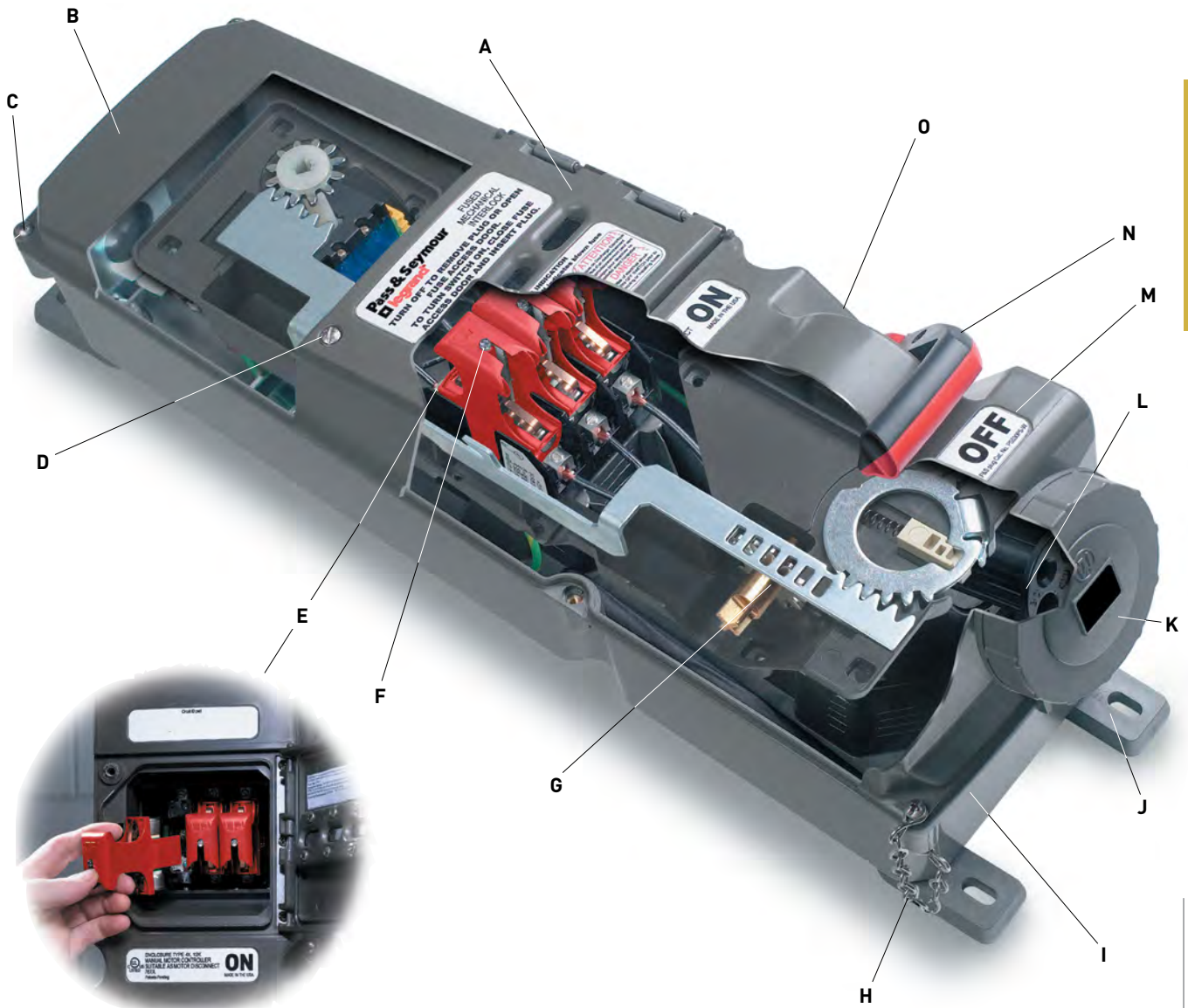

SWITCH DISCONNECTS & MANUAL MOTOR CONTROLLERS

Fusible Mechanical Interlock

Fusible Mechanical Interlock Features:

- A. Hinged access door** with windows allows clear viewing of blown-fuse LED indicators and provides fast, easy access to fuse pullers.
- B. Compact design** fits in most I-beams to provide mounting versatility, easy access, and reduced possibility of impact damage.
- C. Corrosion-resistant, stainless steel captive screws** speed installation, minimize risk of lost parts, and withstand abuse.
- D. Captive, quick-release, stainless steel screws** speed fuse removal, ensure a watertight access door seal, and won't fall out.
- E. Patent-pending integral fuse pullers** with easy-grip ergonomics make removing and replacing blown fuses simple, comfortable, and quick.
- F. Time-saving LED indicators** identify blown fuses at a glance.
- G. Heavy-duty, steel-gear switch mechanism** provides enhanced durability and extra-long service life.
- H. Durable, stainless steel cover-retaining chain** makes installation and maintenance more convenient.
- I. Easy to drill for bottom wiring access, top wiring access — or both.** Only one catalog number per amp rating — simplifies ordering and provides maximum application flexibility.
- J. Adjustable mounting feet** can be moved to center of unit for instant strut- or pole-mounting without special brackets or harnesses. Oversized foot design eliminates the need for washers.
- K. Completely interchangeable** with all manufacturers' IEC 309-1 and 309-2 plugs for economy and versatility.
- L. Durable brass/nickel-plated contacts** ensure reliable, long-lasting electrical performance and corrosion resistance.
- M. Color-coded label** clearly identifies voltage rating of mating IEC plug for fast identification.
- N. Heavy-duty, ergonomic switch handle meets OSHA Lockout/Tagout requirements** and provides plenty of grip for sure, easy operation. Black/red color coding and high-visibility ON/OFF markings clearly indicate status from a distance and at any visual angle.
- O. Nonconductive, watertight, corrosion- and impact-resistant Valox® enclosure** ensures NEMA 4X and 12 ratings. Withstands the harshest industrial environments.

SWITCH DISCONNECTS & MANUAL MOTOR CONTROLLERS

Fusible Mechanical Interlock Ordering Information & Dimensions

POLES/WIRES	VOLTAGE	STANDARD HORSEPOWER RATING	MAXIMUM HORSEPOWER RATING	INTERLOCK RECEPTACLE CATALOG #	PIN & SLEEVE PLUG CATALOG #
20 AMPS					
3P4W	120/240VAC	1/4 HP @ 120VAC	1 HP @ 120VAC	PS420FMIR12W	PS420P12W
		1/2 HP @ 208VAC	2 HP @ 208VAC		
		1/2 HP @ 240VAC	2 HP @ 240VAC		
3P4W	3Ø 240VAC	1 1/2 HP	5 HP	PS420FMIR9W	PS420P9W
3P4W	3Ø 480VAC	3 HP	10 HP	PS420FMIR7W	PS420P7W
3P4W	3Ø 600VAC	5 HP	15 HP	PS420FMIR5W	PS420P5W
30 AMPS					
2P3W	240VAC	1 HP @ 208VAC	3 HP @ 208VAC	PS330FMIR6W	PS330P6W
		1 1/2 HP @ 240VAC	3 HP @ 240VAC		
		1/2 HP @ 120VAC	2 HP @ 120VAC		
3P4W	120/240VAC	1 HP @ 208VAC	3 HP @ 208VAC	PS430FMIR12W	PS430P12W
		1 1/2 HP @ 240VAC	3 HP @ 240VAC		
3P4W	3Ø 240VAC	3 HP	7 1/2 HP	PS430FMIR9W	PS430P9W
3P4W	3Ø 480VAC	5 HP	15 HP	PS430FMIR7W	PS430P7W
3P4W	3Ø 600VAC	7 1/2 HP	15 HP	PS430FMIR5W	PS430P5W
3P4W	3Ø 380/440VAC	5 HP @ 380VAC	15 HP @ 380VAC	PS430FMIR3W	PS430P3W
		5 HP @ 440VAC	15 HP @ 440VAC		
4P5W	3ØY 120/208VAC	2 HP	5 HP	PS530FMIR9W	PS530P9W
4P5W	3ØY 277/480VAC	5 HP	15 HP	PS530FMIR7W	PS530P7W
4P5W	600VAC	7.5 HP	20 HP	PS530FMIR5W	PS530P5W
60 AMPS					
2P3W	240VAC	3 HP @ 208VAC	7 1/2 HP @ 208VAC	PS360FMIR6W	PS360P6W
		3 HP @ 240VAC	7 1/2 HP @ 240VAC		
		1 1/2 HP @ 120VAC	3 HP @ 120VAC		
3P4W	120/240VAC	3 HP @ 208VAC	7 1/2 HP @ 208VAC	PS460FMIR12W	PS460P12W
		3 HP @ 240VAC	10 HP @ 240VAC		
3P4W	3Ø 240VAC	5 HP	15 HP	PS460FMIR9W	PS460P9W
3P4W	3Ø 480VAC	10 HP	30 HP	PS460FMIR7W	PS460P7W
3P4W	3Ø 600VAC	15 HP	40 HP	PS460FMIR5W	PS460P5W
4P5W	3ØY 120/208VAC	5 HP	15 HP	PS560FMIR9W	PS560P9W
4P5W	3ØY 277/480VAC	10 HP	30 HP	PS560FMIR7W	PS560P7W
4P5W	3ØY 347/600VAC	15 HP	40 HP	PS560FMIR5W	PS560P5W
100 AMPS					
3P4W	120/240VAC	2 HP @ 120VAC	5 HP @ 120VAC	PS4100FMIR12W	PS4100P12W
		5 HP @ 208VAC	10 HP @ 208VAC		
		5 HP @ 240VAC	15 HP @ 240VAC		
3P4W	3Ø 240VAC	10 HP	25 HP	PS4100FMIR9W	PS4100P9W
3P4W	3Ø 480VAC	20 HP	50 HP	PS4100FMIR7W	PS4100P7W
3P4W	3Ø 600VAC	30 HP	50 HP	PS4100FMIR5W	PS4100P5W
4P5W	3ØY 120/208VAC	10 HP	20 HP	PS5100FMIR9W	PS5100P9W
4P5W	3ØY 277/480VAC	20 HP	50 HP	PS5100FMIR7W	PS5100P7W
4P5W	3ØY 347/600VAC	30 HP	50 HP	PS5100FMIR5W	PS5100P5W

(HP Ratings subject to change.)

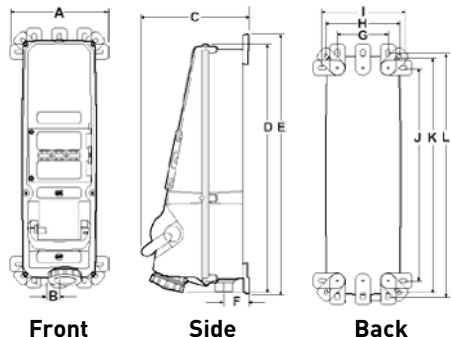

Fusible Mechanical Interlock Dimensions

Amps	A	B	C	D	E	F	G	H	I	J	K	L
20	9.13	1.19	10.09	23.34	24.50	1.97	4.75	6.88	7.75	20.13	22.25	23.13
3 & 4 Wire - 30	9.13	1.19	9.53	23.69	24.50	1.97	4.75	6.88	7.75	20.13	22.25	23.13
5 Wire - 30	9.13	1.19	9.53	23.78	24.50	1.97	4.75	6.88	7.75	20.13	22.25	23.13
60	9.13	1.19	9.94	24.59	24.50	2.25	4.75	6.88	7.75	20.13	22.25	23.13
100	11.13	1.75	11.06	27.94	28.31	2.41	6.75	8.88	9.75	23.94	26.06	26.94

All measurements shown in inches.

Hub shown at bottom of unit for reference only; may be field-installed for top or bottom entry.

SWITCH DISCONNECTS & MANUAL MOTOR CONTROLLERS

Fusible Mechanical Interlock Materials of Manufacture Typical/Sample Spec

Typical Specifications

- Manufacturer's Identification: Pass & Seymour® PS560FMIR5W
- Description: Fusible Pin & Sleeve Mechanical Interlock
- Electrical Type: 3 Pole + Neutral + Earth
- Rating: 60A 3Ø 600VAC 15 HP standard, 50 HP maximum
- Configuration: IEC clock position 5
- Enclosure Type: NEMA 4X (watertight, hosedown), 12K (dusttight, falling dirt), IP67 suitability
- Conduit Location: Top or bottom feed. Unit shipped with no holes drilled; a top and bottom feed spot drill is provided for locating hole saw or knockout. End user decides at installation whether top or bottom feed is appropriate. No closure plug kits required.

MATERIALS	
Enclosure Cover	Valox 357®
Enclosure Base	Valox 357®
Enclosure Door	Valox 357®
Enclosure Gasket	Neoprene
Door Hinge	316 Stainless Steel
Switch Handle	Valox 357®
Switch Handle Seal	Neoprene
Shaft	Brass
Gear Mechanism	1/8" Zinc-Plated Steel
Locktab	10% Glass-Filled Nylon
Switch Key	10% Glass-Filled Nylon
Mounting Feet	Valox 357®
Mounting Feet Screws	300 Series Stainless Steel
Enclosure Assembly Screws	300 Series Stainless Steel
Enclosure Assembly Inserts	Brass
Receptacle Lid	Valox 357®
Receptacle Gasketing	Neoprene
Receptacle Lid Hinge Spring	300 Series Stainless Steel
Receptacle Contact Carrier	Polyamide 6
Receptacle Sleeves	20-60 amp Brass/Nickel Plate 100 amp Brass/Silver Plate
Receptacle Terminal Screws	Zinc-Plated Steel
Grounding Plate	Zinc-Plated Steel
Cover Chain	300 Series Stainless Steel
Conduit Hub	Aluminum/Zinc
	20/30 amp shipped with one (1) 1"
	60 amp shipped with one (1) 1 1/4"
	100 amp shipped with one (1) 1 1/2" (will also fit a 2" hub, not provided)
Viewing Slots in Fuse-Access Door	1/8" thick glass lens

PERFORMANCE	
Electrical:	
Fuse Type	Class "J"
Dielectric Voltage Withstand	3000V minimum
Maximum Working Voltage	600V RMS
Current Interrupting	Listed for current interrupting at full-rated current and voltage
Short Circuit Withstand Rating	For use on circuit capable of delivering not more than 10,000 RMS amps at receptacle voltage rating
Operations	Mechanical: 15,000 cycles Electrical: 10,000 cycles
Auxiliary Contacts	10A @ 600VAC 1 N.O. & 1 N.C.
Mechanical:	
Impact Resistance	Per UL746C
Terminal Identification	Per UL, CSA, and IEC specifications
Product Identification	Identification and rating on external and internal labels
Mounting	External adjustable feet with five (5) positions Can be mounted directly w/o channel or strut (no washers required)
Environmental:	
Moisture Resistance	Per UL50, section 35, NEMA Enclosure Type 4X (watertight, hosedown) Per UL50, section 35, NEMA Enclosure Type 12K (dusttight, falling dirt) IP67 suitability
Flammability	UL94 5VA and VO Classification
Operating Temperature	Maximum continuous: +60°C Minimum continuous: -50°C without impact
UV Resistance	All enclosure materials are UV stable

SWITCH DISCONNECTS & MANUAL MOTOR CONTROLLERS

Non-Fusible Mechanical Interlock



Performance and quality you can see at a distance. Now take a closer look.

P&S Non-Fusible Interlocks are easy to apply, thanks to their versatile, adjustable mounting feet, compact dimensions, and flexible wiring via either top or bottom feed. And once installed, they'll withstand tough conditions — including water in wash-down areas, contamination from shavings, dirt, and dust; accidental impacts, heat from furnaces, welding or other processes; and vibration from any type of equipment.

Here's the safety that goes beyond ordinary requirements. These Interlocks feature a patent-pending, tamper-resistant activating assembly and cover-integral switch mechanism that protect against unauthorized overrides. And high-visibility ON/OFF designations plus a hefty black/red handle make status easy to read at a glance.

Take a close look at our 20 to 100 amp Non-Fusible Interlocks — and see the design and construction that works for you.

SWITCH DISCONNECTS & MANUAL MOTOR CONTROLLERS

Non-Fusible Mechanical Interlock

Non-Fusible Mechanical Interlock Operating Sequence

1. When there is no plug in the device, the lock tab is in the "off" position and prevents the lock gear from turning. The handle cannot be moved to the "on" position.
2. Upon inserting a plug, the lock tab moves from the "off" position, freeing the lock gear.
3. The handle can then be moved to the "on" position. This rotates the lock gear and engages the key on the plug to prevent it from being removed. At the same time, the rack is actuated and rotates the switch gear, turning on the switch and inducing power.
4. Returning the handle to the "off" position frees the lock gear, disengaging the plug key from the switch and allowing the plug to be removed.

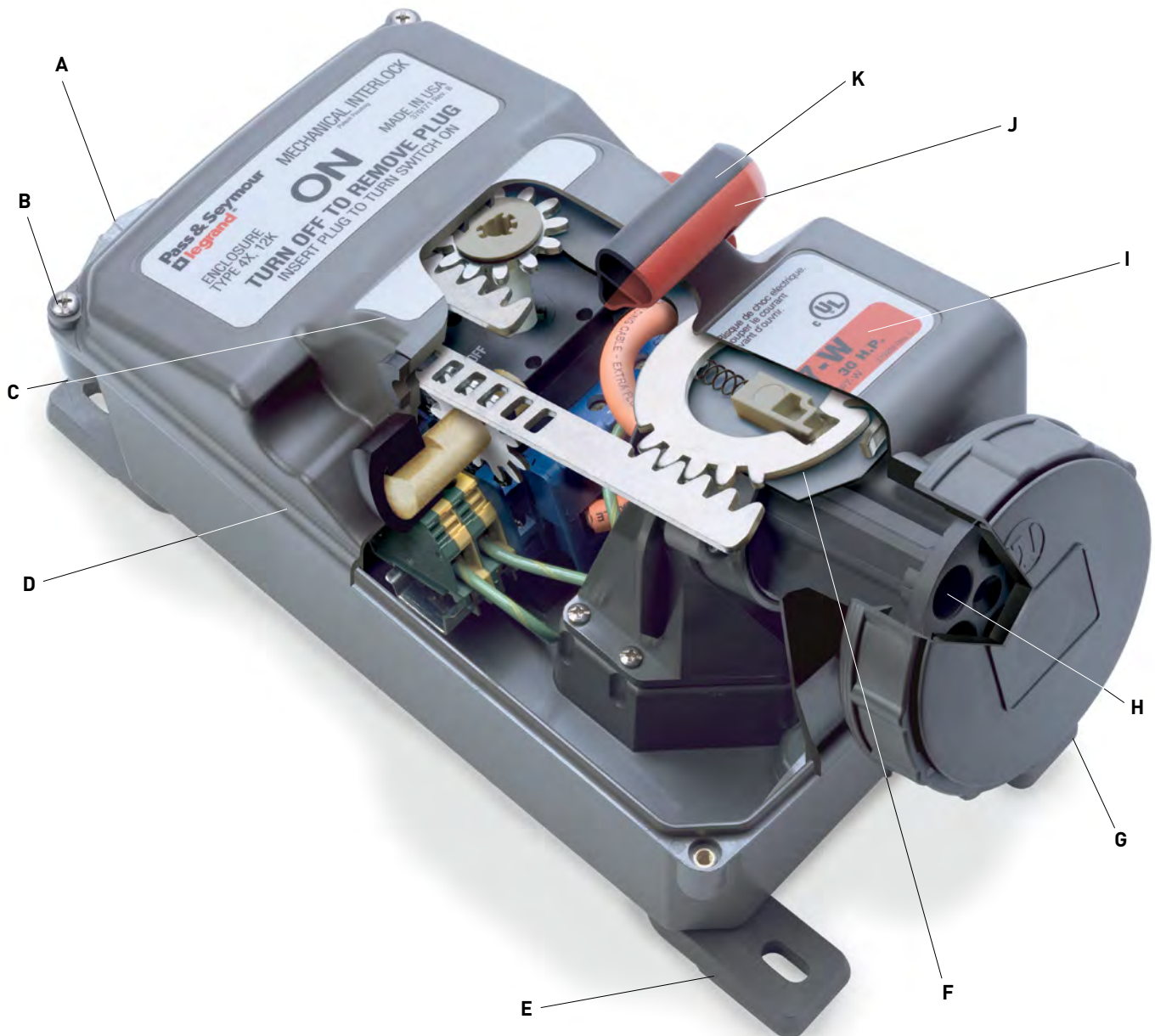

SWITCH DISCONNECTS & MANUAL MOTOR CONTROLLERS

IP67
Suitability

Non-Fusible Mechanical Interlock

Non-Fusible Mechanical Interlock Features:

- A. Top- or bottom-feed models** offer installation flexibility and eliminate the need for time-consuming modifications like drilling and plugging that may nullify the NEMA 4X enclosure rating. Off-center cable entry directs condensation away from internal circuitry — reducing the risk of shorts and corrosion.
- B. Stainless steel captive screws** speed up installation, minimize risk of lost parts, and resist corrosion.
- C. Exclusive circuit ID pad** for fast identification of the motor circuit. Accepts preprinted labels or handwritten data.
- D. Nonconductive, watertight, corrosion- and impact-resistant Valox® enclosure** ensures NEMA 4X and 12 ratings, withstands the harshest industrial environments.
- E. Adjustable mounting feet** provide optimum flexibility when mounting to equipment and walls. Feet can also be moved to center of unit, for instant strut- or pole-mounting without special brackets or harnesses. And our oversized foot design eliminates the need for washers.
- F. Patent-pending, tamper-resistant activating assembly and cover-integral switch mechanism** protect against unauthorized overrides, ensuring operator safety.
- G. Completely interchangeable** with all manufacturers' IEC 309-1 and 309-2 plugs.
- H. Durable brass/nickel-plated contacts** ensure reliable, long-lasting electrical performance and corrosion resistance.
- I. Label is color coded** to correspond with the voltage ratings of all mating IEC plugs for easy visual identification.
- J. Heavy-duty, lever-style switch handle** ensures a firm grip — even with wet, greasy hands. Black/red color-coded handle and high-visibility ON/OFF markings clearly indicate power supply status from a distance and from all angles. Handle enters enclosure from one side to minimize damage due to frontal impacts; entry is offset and sealed to prevent moisture contamination during washdowns.
- K. Handle meets OSHA Lockout/Tagout requirements.**
- Compact design** doesn't protrude, avoids unnecessary knocks, allows for versatile mounting, and fits into standard I-beams and channels.
- Top mount auxiliary contacts are standard** to simplify ordering, purchasing, inventory, and installation requirements.
- Stainless steel cover retaining chain** allows for easy installation and maintenance.

SWITCH DISCONNECTS & MANUAL MOTOR CONTROLLERS

Non-Fusible Mechanical Interlock Ordering Information & Dimensions

POLES/WIRES	VOLTAGE	HORSEPOWER RATING	RECEPTACLE CATALOG #	PIN & SLEEVE PLUG CATALOG #
20 AMPS				
2P3W	120VAC	5 HP	PS320MIR4W	PS320P4W
2P3W	240VAC	5 HP	PS320MIR6W	PS320P6W
2P3W	480VAC	5 HP	PS320MIR7W	PS320P7W
3P4W	120/240VAC	1 HP (120VAC); 2 HP (208-240VAC L-L)	PS420MIR12W	PS420P12W
3P4W	3 ϕ 240VAC	5 HP	PS420MIR9W	PS420P9W
3P4W	3 ϕ 480VAC	10 HP	PS420MIR7W	PS420P7W
3P4W	3 ϕ 600VAC	15 HP	PS420MIR5W	PS420P5W
4P5W	3 ϕ Y 120/208VAC	5 HP	PS520MIR9W	PS520P9W
30 AMPS				
2P3W	120VAC	2 HP	PS330MIR4W	PS330P4W
2P3W	240VAC	5 HP	PS330MIR6W	PS330P6W
2P3W	480VAC	10 HP	PS330MIR7W	PS330P7W
3P4W	3 ϕ 240VAC	7½ HP	PS430MIR9W	PS430P9W
3P4W	3 ϕ 480VAC	15 HP	PS430MIR7W	PS430P7W
3P4W	3 ϕ 600VAC	20 HP	PS430MIR5W	PS430P5W
3P4W	3 ϕ Y 120/208VAC	15 HP	PS430MIR3W	PS430P3W
4P5W	3 ϕ Y 120/208VAC	5 HP	PS530MIR9W	PS530P9W
4P5W	3 ϕ Y 277/480VAC	15 HP	PS530MIR7W	PS530P7W
4P5W	3 ϕ Y 347/600VAC	20 HP	PS530MIR5W	PS530P5W
60 AMPS				
2P3W	120VAC	5 HP	PS360MIR4W	PS360P4W
2P3W	240VAC	7½ HP (208-240VAC)	PS360MIR6W	PS360P6W
2P3W	480VAC	10 HP	PS360MIR7W	PS360P7W
3P4W	120/240VAC	3 HP (120VAC); 7½ HP (208-240VAC L-L)	PS460MIR12W	PS460P12W
3P4W	3 ϕ 240VAC	15 HP	PS460MIR9W	PS460P9W
3P4W	3 ϕ 480VAC	30 HP	PS460MIR7W	PS460P7W
3P4W	3 ϕ 600VAC	40 HP	PS460MIR5W	PS460P5W
4P5W	3 ϕ Y 120/208VAC	15 HP	PS560MIR9W	PS560P9W
4P5W	3 ϕ Y 277/480VAC	30 HP	PS560MIR7W	PS560P7W
4P5W	3 ϕ Y 347/600VAC	40 HP	PS560MIR5W	PS560P5W
4P5W	347/600VAC	40 HP	PS560MIR5W	PS560P5W
100 AMPS				
2P3W	120VAC	5 HP	PS3100MIR4W	PS3100P4W
2P3W	240VAC	10 HP (208VAC); 15 HP (240VAC)	PS3100MIR6W	PS3100P6W
2P3W	480VAC	30 HP	PS3100MIR7W	PS3100P7W
3P4W	3 ϕ 600VAC	50 HP	PS4100MIR5W	PS4100P5W
3P4W	3 ϕ 480VAC	50 HP	PS4100MIR7W	PS4100P7W
3P4W	3 ϕ 240VAC	25 HP	PS4100MIR9W	PS4100P9W
3P4W	120/240VAC	5 HP (120VAC); 10 HP (208VAC L-L); 15 HP (240VAC L-L)	PS4100MIR12W	PS4100P12W
4P5W	3 ϕ Y 347/600VAC	50 HP	PS5100MIR5W	PS5100P5W
4P5W	3 ϕ Y 277/480VAC	50 HP	PS5100MIR7W	PS5100P7W
4P5W	3 ϕ Y 120/208VAC	20 HP	PS5100MIR9W	PS5100P9W

All products are top or bottom feed. Unit shipped with no holes drilled; a top and bottom feed spot drill is provided for locking hole saw or knockout. End user decides whether top or bottom feed is appropriate. No closure plug kits required. HP ratings subject to change.

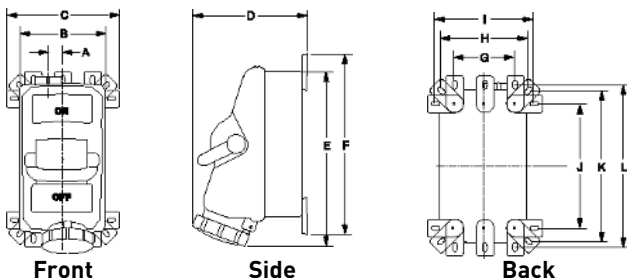

[See dimensions in chart on J-13.]

SWITCH DISCONNECTS & MANUAL MOTOR CONTROLLERS

Non-Fusible Mechanical Interlock Materials of Manufacture Typical/Sample Spec

Typical Specifications

- Manufacturer's Identification: Pass & Seymour® PS560MIR5W
- Description: Non-Fusible Pin & Sleeve Mechanical Interlock
- Electrical Type: 3 Pole + Neutral + Earth
- Rating: 60A 3Ø 600VAC 15 HP standard, 40 HP maximum
- Configuration: IEC clock position 5
- Enclosure Type: NEMA 4X (watertight, hosedown), 12K (dust-tight, falling dirt), IP67 suitability
- Conduit Location: Top or bottom feed. Unit shipped with no holes drilled; a top and bottom feed spot drill is provided for locating hole saw or knockout. End user decides at installation whether top or bottom feed is appropriate. No closure plug kits required.

MATERIALS	
Enclosure Cover	Valox 357®
Enclosure Base	Valox 357®
Enclosure Gasket	Neoprene
Switch Handle	Valox 357®
Switch Handle Seal	Neoprene
Shaft	Brass
Gear Mechanism	1/8" Zinc-Plated Steel
Locktab	10% Glass-Filled Nylon
Switch Key	10% Glass-Filled Nylon
Mounting Feet	Valox 357®
Mounting Feet Screws	300 Series Stainless Steel
Enclosure Assembly Screws	300 Series Stainless Steel
Enclosure Assembly Inserts	Brass
Receptacle Lid	Valox 357®
Receptacle Gasketing	Neoprene
Receptacle Lid Hinge Spring	300 Series Stainless Steel
Receptacle Contact Carrier	Polyamide 6
Receptacle Sleeves	Brass/Nickel Plate
Receptacle Terminal Screws	Zinc-Plated Steel
Grounding Plate	Zinc-Plated Steel
Cover Chain	300 Series Stainless Steel
Conduit Hub	Aluminum/Zinc
	20/30 amp shipped with one (1) 1" 60 amp shipped with one (1) 1 1/4" 100 amp shipped with one (1) 1 1/2" (will also fit a 2" hub, not provided)

PERFORMANCE	
Electrical:	
Dielectric Voltage Withstand	3000V minimum
Maximum Working Voltage	600V RMS
Current Interrupting	Listed for current interrupting at full-rated current and voltage
Short Circuit Withstand Rating	For use on circuit capable of delivering not more than 10,000 RMS amps at receptacle voltage rating
Operations	Mechanical: 15,000 cycles Electrical: 10,000 cycles
Auxiliary Contacts	10A @ 600VAC 1 N.O. & 1 N.C.
Mechanical:	
Impact Resistance	Per UL746C
Terminal Identification	Per UL, CSA, and IEC specifications
Product Identification	Identification and rating on external and internal labels
Mounting	External adjustable feet with five (5) positions Can be mounted directly to channel or strut (no washers required)
Environmental:	
Moisture Resistance	Per UL50, section 35, NEMA Enclosure Type 4X (watertight, hosedown) Per UL50, section 35, NEMA Enclosure Type 12K (dusttight, falling dirt) IP67 suitability
Flammability	UL94 5VA and V0 Classification
Operating Temperature	Maximum continuous: +60°C Minimum continuous: -50°C without impact
UV Resistance	All enclosure materials are UV stable

Non-Fusible Mechanical Interlock Dimensions

Amps	A	B	C	D	E	F	G	H	I	J	K	L
20	1.38	6.88	9.13	8.00	12.38	11.06	4.75	6.88	7.75	8.00	10.13	11.00
30	1.38	6.88	9.13	8.25	12.38	11.50	4.75	6.88	7.75	8.00	10.13	11.00
60	1.19	6.88	9.13	9.00	13.63	14.13	4.75	6.88	7.75	9.75	11.88	12.75
100	1.19	6.88	9.13	9.50	14.13	14.13	4.75	6.88	7.75	9.75	11.88	12.75

All measurements shown in inches.

PIN & SLEEVE DEVICES



Take a closer look at fast-installing Pin & Sleeve products that work for you.

There's no better protection against moisture and industrial contaminants than P&S IEC Pin & Sleeve products. With spring-loaded covers, locking rings, and neoprene gaskets, everything from water to dirt is completely shut out of the electrical system — even if the connection is accidentally submerged!

All P&S Watertight Pin & Sleeve plugs, connectors, receptacles, and inlets bring you the features to enhance versatility, reliability, and safety. For example, North American products come completely ready to wire, for quick, simple installation. And all feature impact- and chemical-resistant thermoplastic construction. Shrouded, nickel-plated, solid-brass pins provide corrosion protection and excellent conductivity. And an exclusive, hinged cord grip eliminates loose parts that get lost.

With a complete range of choices rated from 20 to 100 amps, you'll find a Legrand works-for-you solution for every Pin & Sleeve application in and around your plant.

PIN & SLEEVE DEVICES

Ratings, compliances visible on strap for fast, long-lasting I.D.

- A. Arrives ready to wire, with cord grip open** and cable-ready; terminal screws come backed out and ready to wire; front and back body require no disassembly prior to assembly.
- B. Nylon construction for high-impact** and corrosion resistance.

C. Nickel-plated brass pins provide extracorrosion resistance without sacrificing electrical conductivity.

D. Locking ring with an integral neoprene gasket provides watertight seal when plug and connector/receptacle are mated.

E. Natural-rubber grommets provide watertight protection at cable entry.

F. Combination-head screws for added convenience and quick installation.

G. Revolutionary, hinged cord grip for durable performance and ease of installation.

H. Cover with integral neoprene gasket provides watertight seal.



P&S Pin & Sleeve products provide installation ease, enduring performance in harsh conditions, and guaranteed IEC 309 compatibility.

PIN & SLEEVE DEVICES

IP67
Suitability

North American Watertight Devices Ordering Information



PS330C4WL

PS330P4WL

North American Product Offering

UL SF	CONFIGURATION		VOLTAGE/ COLOR CODING	WATERTIGHT			BACK BOXES		REPLACEMENT PARTS			
				RECEPTACLE	PLUG	CONNECTOR	METALLIC BACK BOX	NON-METALLIC BACK BOX	BODIES		CAPS	
	RECEP./ CONN.	PLUG/ INLET		RECEPTACLE	PLUG	CONNECTOR	METALLIC BACK BOX	NON-METALLIC BACK BOX	PLUG	CONNECTOR	RECEPTACLE	CONNECTOR
20 AMPS												
2P3W			125	PS320R4W	PS320P4W	PS320C4W	PSBB201W	PSBBN201W	PS320P4WR	PS320C4WR	PS320R4WL	
2P3W			250	PS320R6W	PS320P6W	PS320C6W	PSBB201W	PSBBN201W	PS320P6WR	PS320C6WR	PS320R6WL	
2P3W			480	PS320R7W	PS320P7W	PS320C7W	PSBB201W	PSBBN201W	PS320P7WR	PS320C7WR	PS320R7WL	
2P3W			277	PS320R5W	PS320P5W	PS320C5W	PSBB201W	PSBBN201W	PS320P5WR	PS320C5WR	PS320R5WL	
3P4W			125/250	PS420R12W	PS420P12W	PS420C12W	PSBB202W	PSBBN202W		PS420C12WR	PS420R12WL	
3P4W			3ø 250	PS420R9W	PS420P9W	PS420C9W	PSBB202W	PSBBN202W	PS420P9WR	PS420C9WR		
3P4W			3ø 480	PS420R7W	PS420P7W	PS420C7W	PSBB202W	PSBBN202W		PS420C7WR		
3P4W			3ø 600	PS420R5W	PS420P5W	PS420C5W	PSBB202W	PSBBN202W	PS420P5WR	PS420C5WR		
4P5W			3øY 120/208	PS520R9W	PS520P9W	PS520C9W	PSBB202W	PSBBN202W	PS520P9WR	PS520C9WR		
4P5W			3øY 277/480	PS520R7W	PS520P7W	PS520C7W	PSBB202W	PSBBN202W	PS520P7WR	PS520C7WR		
4P5W			3øY 347/600	PS520R5W	PS520P5W	PS520C5W	PSBB202W	PSBBN202W	PS520P5WR	PS520C5WR		
30 AMPS												
2P3W			125	PS330R4W	PS330P4W	PS330C4W	PSBB301W	PSBBN301W			PS330R4WL	PS330C4WL
2P3W			250	PS330R6W	PS330P6W	PS330C6W	PSBB301W	PSBBN301W				PS330C6WL
2P3W			480	PS330R7W	PS330P7W	PS330C7W	PSBB301W	PSBBN301W	PS330P7WR	PS330C7WR	PS330R7WL	PS330C7WL
3P4W			125/250	PS430R12W	PS430P12W	PS430C12W	PSBB301W	PSBBN301W	PS430P12WR	PS430C12WR		PS430C12WL
3P4W			3ø 250	PS430R9W	PS430P9W	PS430C9W	PSBB301W	PSBBN301W	PS430P9WR	PS430C9WR	PS430R9WL	
3P4W			3ø 480	PS430R7W	PS430P7W	PS430C7W	PSBB301W	PSBBN301W	PS430P7WR	PS430C7WR		
3P4W			3ø 600	PS430R5W	PS430P5W	PS430C5W	PSBB301W	PSBBN301W				PS430C5WL
3P4W*			380/440	PS430R3W	PS430P3W	PS430C3W	PSBB301W	PSBBN301W	PS430P3WR	PS430C3WR	PS430R3WL	
4P5W			3øY 120/208	PS530R9W	PS530P9W	PS530C9W	PSBB301W	PSBBN301W	PS530P9WR	PS530C9WR	PS530R9WL	PS530C9WL
4P5W			3øY 277/480	PS530R7W	PS530P7W	PS530C7W	PSBB301W	PSBBN301W	PS530P7WR	PS530C7WR	PS530R7WL	PS530C7WL
4P5W			3øY 347/600	PS530R5W	PS530P5W	PS530C5W	PSBB301W	PSBBN301W	PS530P5WR	PS530C5WR	PS530R5WL	PS530C5WL

*Application specific, reference Page J-3.

PIN & SLEEVE DEVICES

IP67
Suitability

North American Watertight Devices Ordering Information

North American Product Offering

UL SR	CONFIGURATION		VOLTAGE/ COLOR CODING	WATERTIGHT				BACK BOXES		REPLACEMENT PARTS			
	RECEP./ CONN.	PLUG/ INLET		RECEPTACLE†	PLUG	CONNECTOR	INLET	METALLIC BACK BOX	NON-METALLIC BACK BOX	BODIES		CAPS	
										PLUG	CONNECTOR	RECEPTACLE	CONNECTOR
60 AMPS													
2P3W			125	PS360R4W	PS360P4W	PS360C4W	PS360B4W	PSBB601W	PSBBN601W		PS360C4WR		PS360C4WL
2P3W			250	PS360R6W	PS360P6W	PS360C6W	PS360B6W	PSBB601W	PSBBN601W	PS360P6WR	PS360C6WR		
2P3W			480	PS360R7W	PS360P7W	PS360C7W	PS360B7W	PSBB601W	PSBBN601W	PS360P7WR	PS360C7WR	PS360R7WL	PS360C7WL
3P4W			125/250	PS460R12W	PS460P12W	PS460C12W	PS460B12W	PSBB601W	PSBBN601W	PS460P12WR	PS460C12WR		PS460C12WL
3P4W			3ø 250	PS460R9W	PS460P9W	PS460C9W	PS460B9W	PSBB601W	PSBBN601W		PS460C9WR		
3P4W			3ø 480	PS460R7W	PS460P7W	PS460C7W	PS460B7W	PSBB601W	PSBBN601W				
3P4W			3ø 600	PS460R5W	PS460P5W	PS460C5W	PS460B5W	PSBB601W	PSBBN601W			PS460R5WL	
4P5W			3øY 120/208	PS560R9W	PS560P9W	PS560C9W	PS560B9W	PSBB601W	PSBBN601W	PS560P9WR			
4P5W			3øY 277/480	PS560R7W	PS560P7W	PS560C7W	PS560B7W	PSBB601W	PSBBN601W	PS560P7WR	PS560C7WR	PS560R7WL	PS560C7WL
4P5W			3øY 347/600	PS560R5W	PS560P5W	PS560C5W	PS560B5W	PSBB601W	PSBBN601W	PS560P5WR	PS560C5WR	PS560R5WL	PS560C5WL
100 AMPS													
2P3W			125	PS3100R4W	PS3100P4W	PS3100C4W	PS3100B4W	PSBB1001W		PS3100P4WR	PS3100C4WR	PS3100R4WL	PS3100C4WL
2P3W			250	PS3100R6W	PS3100P6W	PS3100C6W	PS3100B6W	PSBB1001W			PS3100C6WR	PS3100R6WL	PS3100C6WL
2P3W			480	PS3100R7W	PS3100P7W	PS3100C7W	PS3100B7W	PSBB1001W		PS3100P7WR	PS3100C7WR	PS3100R7WL	PS3100C7WL
3P4W			125/250	PS4100R12W	PS4100P12W	PS4100C12W	PS4100B12W	PSBB1001W			PS4100C12WR		PS4100C12WL
3P4W			3ø 250	PS4100R9W	PS4100P9W	PS4100C9W	PS4100B9W	PSBB1001W			PS4100C9WR		PS4100C9WL
3P4W			3ø 480	PS4100R7W	PS4100P7W	PS4100C7W	PS4100B7W	PSBB1001W				PS4100R7WL	PS4100C7WL
3P4W			3ø 600	PS4100R5W	PS4100P5W	PS4100C5W	PS4100B5W	PSBB1001W			PS4100C5WR	PS4100R5WL	PS4100C5WL
4P5W			3øY 120/208	PS5100R9W	PS5100P9W	PS5100C9W	PS5100B9W	PSBB1001W		PS5100P9WR	PS5100C9WR		PS5100C9WL
4P5W			3øY 277/480	PS5100R7W	PS5100P7W	PS5100C7W	PS5100B7W	PSBB1001W		PS5100P7WR		PS5100R7WL	PS5100C7WL
4P5W			3øY 347/600	PS5100R5W	PS5100P5W	PS5100C5W	PS5100B5W	PSBB1001W		PS5100P5WR	PS5100C5WR	PS5100R5WL	PS5100C5WL

† Note: For straight 60 and 100 amp watertight receptacles, add "S" to catalog number after the R, example: PS4100R5W.

PIN & SLEEVE DEVICES

IP44
Suitability

North American Splashproof Devices Ordering Information

North American Product Offering











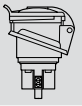
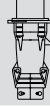
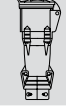

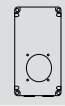





























 	CONFIGURATION		VOLTAGE/ COLOR CODING	SPLASHPROOF				BACK BOXES		NON-METALLIC BACK BOX
	RECEP./ CONN.	PLUG/ INLET		RECEPTACLE	PLUG	CONNECTOR	INLET *	ANGLED BOX	INLET **	RECEPTACLE
20 AMPS										
2P3W			125	PS320R4S	PS320P4S	PS320C4S	PS320B4S	PSBB201W	PSBB201SP	PSBBN201W
2P3W			250	PS320R6S	PS320P6S	PS320C6S	PS320B6S	PSBB201W	PSBB201SP	PSBBN201W
2P3W			277	PS320R5S	PS320P5S	PS320C5S	PS320B5S	PSBB201W	PSBB201SP	PSBBN201W
3P4W			125/250	PS420R12S	PS420P12S	PS420C12S	PS420B12S	PSBB202W	PSBB201SP	PSBBN202W
3P4W			3ø 250	PS420R9S	PS420P9S	PS420C9S	PS420B9S	PSBB202W	PSBB201SP	PSBBN202W
3P4W			3ø 480	PS420R7S	PS420P7S	PS420C7S	PS420B7S	PSBB202W	PSBB201SP	PSBBN202W
3P4W			3ø 600	PS420R5S	PS420P5S	PS420C5S	PS420B5S	PSBB202W	PSBB201SP	PSBBN202W
4P5W			3øY 120/208	PS520R9S	PS520P9S	PS520C9S	PS520B9S	PSBB202W	PSBB201SP	PSBBN202W
4P5W			3øY 277/480	PS520R7S	PS520P7S	PS520C7S	PS520B7S	PSBB202W	PSBB201SP	PSBBN202W
4P5W			3øY 347/600	PS520R5S	PS520P5S	PS520C5S	PS520B5S	PSBB202W	PSBB201SP	PSBBN202W
30 AMPS										
2P3W			125	PS330R4S	PS330P4S	PS330C4S	PS330B4S	PSBB301W	PSBB301SP	PSBBN301W
2P3W			250	PS330R6S	PS330P6S	PS330C6S	PS330B6S	PSBB301W	PSBB301SP	PSBBN301W
2P3W			480	PS330R7S	PS330P7S	PS330C7S	PS330B7S	PSBB301W	PSBB301SP	PSBBN301W
3P4W			125/250	PS430R12S	PS430P12S	PS430C12S	PS430B12S	PSBB301W	PSBB301SP	PSBBN301W
3P4W			3ø 250	PS430R9S	PS430P9S	PS430C9S	PS430B9S	PSBB301W	PSBB301SP	PSBBN301W
3P4W			3ø 480	PS430R7S	PS430P7S	PS430C7S	PS430B7S	PSBB301W	PSBB301SP	PSBBN301W
3P4W			3ø 600	PS430R5S	PS430P5S	PS430C5S	PS430B5S	PSBB301W	PSBB301SP	PSBBN301W
4P5W			3øY 120/208	PS530R9S	PS530P9S	PS530C9S	PS530B9S	PSBB301W	PSBB301SP	PSBBN301W
4P5W			3øY 277/480	PS530R7S	PS530P7S	PS530C7S	PS530B7S	PSBB301W	PSBB301SP	PSBBN301W
4P5W			3øY 347/600	PS530R5S	PS530P5S	PS530C5S	PS530B5S	PSBB301W	PSBB301SP	PSBBN301W
60 AMPS										
2P3W			250	PS360R6S	PS360P6S	PS360C6S	PS360B6S	PSBB601W	PSBB601W	PSBBN601W
2P3W			480	PS360R7S	PS360P7S	PS360C7S	PS360B7S	PSBB601W	PSBB601W	PSBBN601W
3P4W			125/250	PS460R12S	PS460P12S	PS460C12S	PS460B12S	PSBB601W	PSBB601W	PSBBN601W
3P4W			3ø 250	PS460R9S	PS460P9S	PS460C9S	PS460B9S	PSBB601W	PSBB601W	PSBBN601W
3P4W			3ø 480	PS460R7S	PS460P7S	PS460C7S	PS460B7S	PSBB601W	PSBB601W	PSBBN601W
3P4W			3ø 600	PS460R5S	PS460P5S	PS460C5S	PS460B5S	PSBB601W	PSBB601W	PSBBN601W
4P5W			3øY 120/208	PS560R9S	PS560P9S	PS560C9S	PS560B9S	PSBB601W	PSBB601W	PSBBN601W
4P5W			3øY 277/480	PS560R7S	PS560P7S	PS560C7S	PS560B7S	PSBB601W	PSBB601W	PSBBN601W
4P5W			3øY 347/600	PS560R5S	PS560P5S	PS560C5S	PS560B5S	PSBB601W	PSBB601W	PSBBN601W

*Line art for 60 amp only. 20 and 30 amp inlets are angled.
 **Line art for 20 and 30 amp only. 60 amp back box is angled.

PIN & SLEEVE DEVICES

International Splashproof Devices Ordering Information

International Product Offering

POLES & WIRES	CONFIGURATION		VOLTAGE/ COLOR CODING	SPLASHPROOF (IP44 SUITABILITY)				
	RECEP./ CONN.	PLUG/ INLET						
				RECEPTACLE	PLUG	CONNECTOR	INLET	NON-METALLIC BACK BOX
16 AMPS								
2P3W			110/120	51920	51940	51980	51970*	52029
2P3W			220/240	52022	52042	52082	52172*	52029
2P3W			380/415	52222	52242	52282	52272*	52029
3P4W			220/240	52023	52043	52083	52073*	52229
3P4W			380/415	52223	52243	52283	52173*	52229
4P5W			220/240		52044	52084	52074*	52229
4P5W			220/380 240/415	52224	52244	52284	52174	52229
32 AMPS								
2P3W			110/120				51972*	52940
2P3W			220/240	52718	52742	52782	52872*	52940
2P3W			380/415		52942	52982	52972*	52940
3P4W			220/240		52743	52783	52773*	52940
3P4W			380/415	52919	52943	52983	52873*	52940
4P5W			220/240		52744		52774*	52940
4P5W			220/380 240/415	52920	52944	52984	52874*	52940
63 AMPS								
2P3W			110/120	53542	53582			53889
2P3W			220/240	53622	53642	53682	53772*	53889
3P4W			220/240	53623	53643	53683		53889
3P4W			380/415	53823	53843	53883	53773*	53889
4P5W			220/240		53644	53684		53889
4P5W			220/380 240/415	53824	53844	53884	53774*	53889

*Use with Back Box listed for surface mounting. Refer to chart on Page J-25.

Additional international configuration available — consult Factory Export Department.

Watertight versions available. Please consult factory.

Hypra[®] IP 66/67-55 plastic - increased safety

LV 16 to 125 A

63 A and 125 A
easy connection
disconnection

Conform to IEC 60309-1 and IEC 60309-2 IP according to IEC 60529 IK 09: Plastic Self-extinguishing: 850°C (support of active parts) / 650°C (plastic housing)			FUNCTIONS									
			Panel mounting sockets		Surface mounting sockets	Through wiring surface mounting sockets	Straight plugs	Angled plugs	Mobile sockets	Surface appliance inlets	Straight panel appliance inlets	Socket with break isolating switch
			Female connector		Female connector	Female connector	Male connector	Male connector	Female connector	Male connector	Male connector	Female connector
LV			inclined outlets	with single fixing centres								
200 to 250 V _± 50/60 Hz	16 A	2P+E	0 511 26 ⁽¹⁾	0 511 46	0 511 26 + 0 520 29 ⁽¹⁾	0 511 26 + 0 520 89	0 511 56 ⁽¹⁾	0 511 06	0 511 76	0 511 86	-	-
	32 A	2P+E	-	0 530 46	0 530 46 + 0 529 40	0 530 46 + 0 529 90	0 530 56	0 530 06	0 530 76	0 530 86	-	-
380 to 415 V _± 50/60 Hz	16 A	3P+E	0 511 30	0 511 50	0 511 30 + 0 522 29 ⁽¹⁾	0 511 30 + 0 522 89	0 511 60 ⁽¹⁾	0 511 10	0 511 80	0 511 90	-	-
		3P+N+E	0 511 31	0 511 51	0 511 31 + 0 522 29 ⁽¹⁾	0 511 31 + 0 522 89	0 511 61 ⁽¹⁾	0 511 11	0 511 81	0 511 91	-	-
	32 A	3P+E	-	0 530 50	0 530 50 + 0 529 40	0 530 50 + 0 529 90	0 530 60	0 530 10	0 530 80	0 530 90	-	-
		3P+N+E	-	0 530 51	0 530 51 + 0 529 40	0 530 51 + 0 529 90	0 530 61	0 530 11	0 530 81	0 530 91	-	-
	63 A	3P+E	0 594 27	-	0 594 37	0 594 27 + 0 538 89	0 594 47	-	0 594 87	-	0 594 77 ⁽²⁾	-
		3P+N+E	0 594 28	-	0 594 38	0 594 28 + 0 538 89	0 594 48	-	0 594 88	-	0 594 78 ⁽²⁾	-
	125 A	3P+E	0 595 12	-	0 595 02	-	0 595 22	-	0 595 32	-	0 595 42	0 591 14
		3P+N+E	0 595 13	-	0 595 03	-	0 595 23	-	0 595 33	-	0 595 43	0 591 15

Pack = 1 except 1: pack = 5
2: Can be fixed on Cat. No 0 538 89 to obtain a straight surface mounting appliance inlet.

Complete range from 16 A to 125 A: IP 55 (minimum) guaranteed

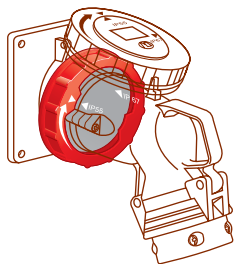

When connected: IP 55 guaranteed with the cover closed on the plug (with a pair of Hypra IP 66/67-55 products)

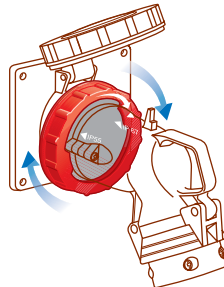

IP 66/67 obtained with the ring locked

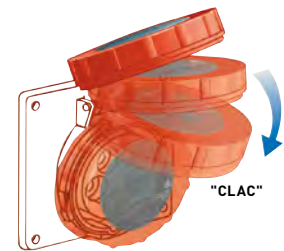











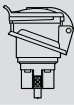





When not connected IP 55 assured when cover is closed; IP 66/67 obtained with the ring locked

PIN & SLEEVE DEVICES

Special Voltages & Frequencies

IP44
Suitability

Special Voltages and Frequencies

POLES & WIRES	CONFIGURATION		VOLTAGE/ COLOR CODING	SPLASHPROOF		
	RECEP./ CONN.	PLUG/ INLET				
				RECEPTACLE	PLUG	CONNECTOR
16 AMPS						
2P			24V	52401	52421	52481
2P			42VDC			
3P			24V	52402		
3P4W			50-500V			
32 AMPS						
2P			24V	52501	52521	52581
2P			42V			
3P4W			50-500V 100/300Hz		52371	

*Use with Back Box listed below for surface mounting.

Additional international configuration available — consult Factory Export Department.

Size	
BACK BOX FOR IP44 NON-METALLIC INLETS AND RECEPTACLES	
16A: 2P3W	52079
63A: All	53879

Device Type	Adapter Plate Leviton, Crouse Hinds/Appleton	Device Type	Adapter Plate Hubbell
COMPETITOR BACK BOX ADAPTER PLATE			
20A 3 Wire	PSAP320CA	20A 3 Wire	PSAP320HBL
20A 4, 5 Wire	PSAP4520CA	20A 4 Wire	PSAP420HBL
All 30A	PSAP30CA	20A 5 Wire & All 30A	PSAP52030HBL
All 60A		All 60A	PSAP60HB

PIN & SLEEVE DEVICES

Watertight Dimensional Information

16/20 & 30/32 Amp Watertight Devices/Dimensional Information

AMPS	WIRE CONFIGURATIONS	A	B	C	D	E	F
WATERTIGHT RECEPTACLES							
16/20	2 Pole, 3 Wire	2.85	1.80	1.60	3.40	2.05	2.36
	3 Pole, 4 Wire	3.20	1.90	1.60	3.80	2.36	2.75
	4 Pole, 5 Wire	3.40	2.00	1.70	3.80	2.36	2.75
30/32	2 Pole, 3 Wire	3.72	2.60	1.80	4.30	2.75	3.15
	3 Pole, 4 Wire	3.72	2.60	1.90	4.30	2.75	3.15
	4 Pole, 5 Wire	3.98	2.70	1.95	4.30	2.75	3.15
WATERTIGHT PLUGS							
16/20	2 Pole, 3 Wire	5.30	2.85		.31-.59		
	3 Pole, 4 Wire	5.50	3.20		.31-.59		
	4 Pole, 5 Wire	6.00	3.40		.39-.71		
30/32	2 Pole, 3 Wire	6.50	3.70		.39-.71		
	3 Pole, 4 Wire	6.50	3.70		.47-.87		
	4 Pole, 5 Wire	6.70	3.98		.47-.87		
WATERTIGHT CONNECTORS							
16/20	2 Pole, 3 Wire	5.90	2.85	3.00	.31-.59		
	3 Pole, 4 Wire	6.00	3.20	3.40	.31-.59		
	4 Pole, 5 Wire	6.70	3.40	3.50	.39-.71		
30/32	2 Pole, 3 Wire	7.00	3.70	3.90	.39-.71		
	3 Pole, 4 Wire	7.00	3.70	3.90	.47-.87		
	4 Pole, 5 Wire	7.30	3.98	4.10	.47-.87		

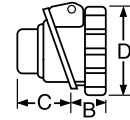
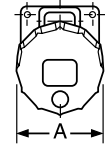

Receptacles

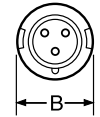
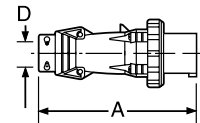

Plugs

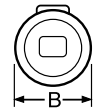
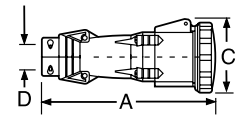

Connectors

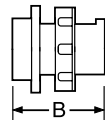
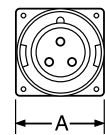

Inlets

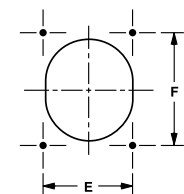

Receptacle/Inlet Drilling Pattern

60/63 Amp Watertight Devices/Dimensional Information

AMPS	WIRE CONFIGURATIONS	A	B	C	D	E	F
WATERTIGHT RECEPTACLES							
60/63	2 Pole, 3 Wire	4.20	3.10	3.50	5.00	3.03	3.35
	3 Pole, 4 Wire	4.20	3.10	3.50	5.00	3.03	3.35
	4 Pole, 5 Wire	4.20	3.10	3.50	5.00	3.03	3.35
WATERTIGHT PLUGS							
60/63	2 Pole, 3 Wire	10.00	4.50		.63-1.04		
	3 Pole, 4 Wire	10.00	4.50		.73-1.14		
	4 Pole, 5 Wire	10.00	4.50		.80-1.26		
WATERTIGHT CONNECTORS							
60/63	2 Pole, 3 Wire	10.90	4.50	4.70	.63-1.04		
	3 Pole, 4 Wire	10.90	4.50	4.70	.73-1.14		
	4 Pole, 5 Wire	10.90	4.50	4.70	.80-1.26		
WATERTIGHT INLETS							
60/63	2 Pole, 3 Wire	4.50	4.25			3.03	3.35
	3 Pole, 4 Wire	4.50	4.25			3.03	3.35
	4 Pole, 5 Wire	4.50	4.25			3.03	3.35

100/125 Amp Watertight Devices/Dimensional Information

AMPS	WIRE CONFIGURATIONS	A	B	C	D	E	F
WATERTIGHT RECEPTACLES							
100/125	2 Pole, 3 Wire	5.20	2.20	4.40	5.60	4.88	4.88
	3 Pole, 4 Wire	5.20	2.20	4.40	5.60	4.88	4.88
	4 Pole, 5 Wire	5.20	2.20	4.40	5.60	4.88	4.88
WATERTIGHT PLUGS							
100/125	2 Pole, 3 Wire	13.40	5.20		.59-1.97		
	3 Pole, 4 Wire	13.40	5.20		.59-1.97		
	4 Pole, 5 Wire	13.40	5.20		.59-1.97		
WATERTIGHT CONNECTORS							
100/125	2 Pole, 3 Wire	14.30	5.20	5.30	.59-1.97		
	3 Pole, 4 Wire	14.30	5.20	5.30	.59-1.97		
	4 Pole, 5 Wire	14.30	5.20	5.30	.59-1.97		
WATERTIGHT INLETS							
100/125	2 Pole, 3 Wire	5.75	5.71			4.88	4.88
	3 Pole, 4 Wire	5.75	5.71			4.88	4.88
	4 Pole, 5 Wire	5.75	5.71			4.88	4.88

PIN & SLEEVE DEVICES

Splashproof Dimensional Information

16/20 & 30/32 Amp Splashproof Devices/Dimensional Information

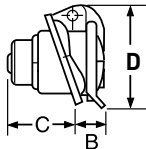
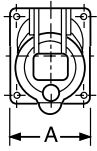

Receptacles

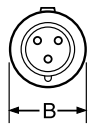
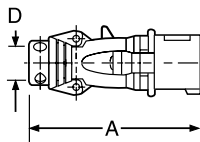

Plugs

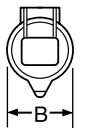
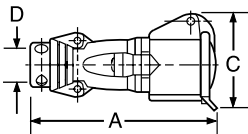

Connectors

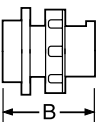
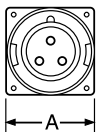

Inlets

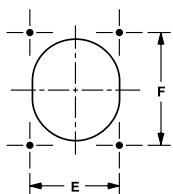

Receptacle/Inlet Drilling Pattern

AMPS	WIRE CONFIGURATIONS	A	B	C	D	E	F
SPLASHPROOF RECEPTACLES							
16/20	2 Pole, 3 Wire	2.50	1.57	1.60	3.10	2.05	2.36
	3 Pole, 4 Wire	2.90	1.57	1.73	3.46	2.36	2.75
	4 Pole, 5 Wire	2.90	1.73	1.73	3.66	2.36	2.75
30/32	2 Pole, 3 Wire	3.30	2.10	1.97	4.06	2.75	3.15
	3 Pole, 4 Wire	3.30	2.10	1.97	4.06	2.75	3.15
	4 Pole, 5 Wire	3.30	2.20	2.05	4.20	2.75	3.15
SPLASHPROOF PLUGS							
16/20	2 Pole, 3 Wire	5.30	2.17		.31-.59		
	3 Pole, 4 Wire	5.50	2.36		.31-.59		
	4 Pole, 5 Wire	6.00	2.60		.39-.71		
30/32	2 Pole, 3 Wire	6.50	2.78		.39-.71		
	3 Pole, 4 Wire	6.50	2.78		.47-.87		
	4 Pole, 5 Wire	6.70	3.03		.47-.87		
SPLASHPROOF CONNECTORS							
16/20	2 Pole, 3 Wire	5.79	2.15	2.91	.31-.59		
	3 Pole, 4 Wire	5.94	2.42	3.19	.31-.59		
	4 Pole, 5 Wire	6.77	2.73	3.54	.39-.71		
30/32	2 Pole, 3 Wire	6.97	2.80	3.66	.39-.71		
	3 Pole, 4 Wire	6.97	2.80	3.66	.47-.87		
	4 Pole, 5 Wire	7.20	3.05	3.94	.47-.87		
SPLASHPROOF INLETS							
16/20	2 Pole, 3 Wire	2.83	3.07			2.44	3.70
	3 Pole, 4 Wire	3.70	3.39			3.27	4.29
	4 Pole, 5 Wire	3.70	3.39			3.27	4.29
30/32	2 Pole, 3 Wire	3.98	4.37			3.54	5.86
	3 Pole, 4 Wire	3.98	4.37			3.54	5.86
	4 Pole, 5 Wire	3.98	4.25			3.54	5.86

60/63 Amp Splashproof Devices/Dimensional Information

AMPS	WIRE CONFIGURATIONS	A	B	C	D	E	F
SPLASHPROOF RECEPTACLES							
60/63	2 Pole, 3 Wire	4.20	3.50	2.76	5.08	3.03	3.35
	3 Pole, 4 Wire	4.20	3.50	2.76	5.08	3.03	3.35
	4 Pole, 5 Wire	4.20	3.50	2.76	5.08	3.03	3.35
SPLASHPROOF PLUGS							
60/63	2 Pole, 3 Wire	10.00	4.02		.63-1.04		
	3 Pole, 4 Wire	10.00	4.02		.73-1.14		
	4 Pole, 5 Wire	10.00	4.02		.80-1.26		
SPLASHPROOF CONNECTORS							
60/63	2 Pole, 3 Wire	10.75	3.78	4.67	.63-1.04		
	3 Pole, 4 Wire	10.75	3.78	4.67	.73-1.14		
	4 Pole, 5 Wire	10.75	3.78	4.67	.80-1.26		
SPLASHPROOF INLETS							
60/63	2 Pole, 3 Wire	4.50	4.25			3.03	3.35
	3 Pole, 4 Wire	4.50	4.25			3.03	3.35
	4 Pole, 5 Wire	4.50	4.25			3.03	3.35

All measurements shown in inches.

PIN & SLEEVE DEVICES

Watertight & Splashproof Material & Performance

Pin & Sleeve Product Specifications

	16/20 AMP	30/32 AMP	60/63 AMP	100/125 AMP
RECEPTACLES				
Housing	Polyamide 6	Polyamide 6	Valox	Valox
Cover	Polyamide 66	Polyamide 66	Valox	Valox
Cover Spring	Stainless Steel	Stainless Steel	Stainless Steel	Stainless Steel
Sealing Gasket†	Neoprene	Neoprene	Neoprene	Neoprene
Mounting Gasket	Neoprene	Neoprene	Neoprene	Neoprene
Contact Carrier	Polyamide 6	Polyamide 6	Polyamide 6	Polyamide 6
Sleeves	Brass w/Nickel Plate*†	Brass w/Nickel Plate*†	Brass w/Nickel Plate	Brass w/Nickel Plate
Terminal Screws	Zinc-Plated Steel	Zinc-Plated Steel	Zinc-Plated Steel	Zinc-Plated Steel
INLETS				
Housing	Polyamide 6	Polyamide 6	Valox	Valox
Mounting Flange	Polyamide 6	Polyamide 6	Valox	Valox
Locking Ring*†	Polyamide 66	Polyamide 66	Valox	Valox
Sealing Gasket†	Neoprene	Neoprene	Neoprene	Neoprene
Mounting Gasket	Neoprene	Neoprene	Neoprene	Neoprene
Contact Carrier	Polyamide 6	Polyamide 6	Polyamide 6	Polyamide 6
Pins	Brass w/Nickel Plate*†	Brass w/Nickel Plate*†	Brass w/Nickel Plate	Brass w/Nickel Plate
Terminal Screws	Zinc-Plated Steel	Zinc-Plated Steel	Zinc-Plated Steel	Zinc-Plated Steel
PLUGS				
Housing	Polyamide 6	Polyamide 6	Valox	Valox
Locking Ring*†	Polyamide 66	Polyamide 66	Valox	Valox
Sealing Gasket†	Neoprene	Neoprene	Neoprene	Neoprene
Housing Gasket	Neoprene	Neoprene	Neoprene	Neoprene
Back Body	Polyamide 6	Polyamide 6	Valox	Valox
Contact Carrier	Polyamide 6	Polyamide 6	Polyamide 6	Polyamide 6
Pins	Brass w/Nickel Plate*†	Brass w/Nickel Plate*†	Brass w/Nickel Plate	Brass w/Nickel Plate
Terminal Screws	Zinc-Plated Steel	Zinc-Plated Steel	Zinc-Plated Steel	Zinc-Plated Steel
Cord Grip	Polyamide 6	Polyamide 6	Polyamide 66	Polyamide 66
Grommet	Natural Rubber	Natural Rubber	Natural Rubber	Natural Rubber
Cord Grip Screws	Stainless Steel	Stainless Steel	Stainless Steel	Stainless Steel
Assembly Screws	Stainless Steel	Stainless Steel	Stainless Steel	Stainless Steel
CONNECTORS				
Housing	Polyamide 6	Polyamide 6	Valox	Valox
Cover	Polyamide 66	Polyamide 66	Valox	Valox
Cover Spring	Stainless Steel	Stainless Steel	Stainless Steel	Stainless Steel
Sealing Gasket†	Neoprene	Neoprene	Neoprene	Neoprene
Housing Gasket	Neoprene	Neoprene	Neoprene	Neoprene
Back Body	Polyamide 6	Polyamide 6	Valox	Valox
Contact Carrier	Polyamide 6	Polyamide 6	Polyamide 6	Polyamide 6
Sleeves	Brass w/Nickel Plate*†	Brass w/Nickel Plate*†	Brass w/Nickel Plate	Brass w/Nickel Plate
Terminal Screws	Zinc-Plated Steel	Zinc-Plated Steel	Zinc-Plated Steel	Zinc-Plated Steel
Cord Grip	Polyamide 6	Polyamide 6	Polyamide 66	Polyamide 66
Grommet	Natural Rubber	Natural Rubber	Natural Rubber	Natural Rubber
Cord Grip Screws	Stainless Steel	Stainless Steel	Stainless Steel	Stainless Steel
Assembly Screws	Stainless Steel	Stainless Steel	Stainless Steel	Stainless Steel
METALLIC BACK BOX				
Housing	Cast Aluminum			
Hub	Cast Iron			
NON-METALLIC BACK BOX				
Housing	Polyamide 6			
Hub				

†Does not apply to splashproof.

*16/20A and 30/32A sleeves and pins on splashproof products are brass only. Splashproof inlets and plugs do not have locking rings.

Consult factory for additional details.

PERFORMANCE

Electrical:

Dielectric Voltage Withstand	3000V maximum
Maximum Working Voltage	600V RMS, 60Hz - 400Hz
Current Interrupting	Certified for current interrupting at full-rated current
Temperature Rise	Maximum 30°C temperature rise at full-rated current after 50 cycles of 150% overload (at 0.75 to 0.80 power factor)
Endurance	20 amp: 5000 cycles with full-rated current and voltage 30, 60, 100 amp: 2000 cycles with full-rated current and voltage applied on every other cycle

Mechanical:

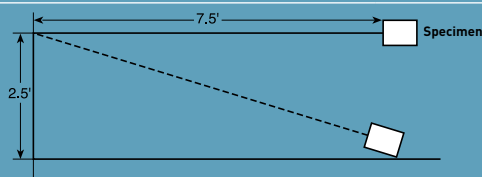

Impact Resistance	Device dropped 8 times from a height of 2.5 feet with 7.5 feet of cord attached (per CSA 182.1)
-------------------	---

Cord Grip Retention	Force, Lbs.**	Torque, Ft.lbs.**
20A	30	0.4
30A	75	0.5
60A	150	1.0
100A	150	1.0

**Applied to minimum recommended cable size.

Cord Accommodation	Round portable service cords Diameters commensurate with the device rating as defined in UL62, CSA C22.2, No. 49, and the harmonized (HAR) European Standard
Terminal Identification	Identified in accordance with North American convention, UL1682, and IEC 309-1, 309-2, rated for copper conductors only
Product Identification	Identification and ratings are labeled on the device housing

Environmental:

Moisture Resistance	Per IEC 309-1
Flammability	Contact with live parts: V2 or V0 Enclosure: HB or better per UL94
Operating Temperature	+80°C maximum continuous; -50°C minimum without impact
UV Resistance	All enclosure materials are UV stable

PIN & SLEEVE DEVICES

Accessories/Dimensional Information

Metallic Back Boxes Dimensions

Catalog Number	A	B	C	D	E	F	G	H	J DIA	K	L
PSBB201W	5.60	5.00	3.17	5.00	2.05	2.36	8-32UNC	2.04	.20 DIA	1/2" NPT	2.75
PSBB202W	6.82	6.12	4.11	6.07	2.36	2.76	8-32UNC	2.55	.20 DIA	3/4" NPT	3.61
PSBB201SP	7.00	5.98	2.00	6.00	3.27	4.29	8-32UNC	3.00	.20 DIA	3/4" NPT	3.96
PSBB301W	6.82	6.12	4.11	6.07	2.76	3.15	8-32UNC	2.55	.20 DIA	3/4" NPT	3.61
PSBB301SP	8.60	7.58	2.00	7.60	3.54	5.87	8-32UNC	3.00	.20 DIA	3/4" NPT	4.22
PSBB601W	8.63	7.75	4.92	7.70	3.03	3.35	10-24UNC	3.87	.28 DIA	1 1/2" NPT	4.75
PSBB1001W	12.50	11.00	6.25	11.00	4.88	4.88	1/4-20UNC	4.75	.28 DIA	1 1/2" NPT	6.25
PSBB1002W	12.50	11.00	6.25	11.00	4.88	4.88	1/4-20UNC	4.75	.28 DIA	2" NPT	6.25

Watertight: Inlets and Receptacles
 Splashproof: 20, 30 & 60A Receptacle
 60A Inlets

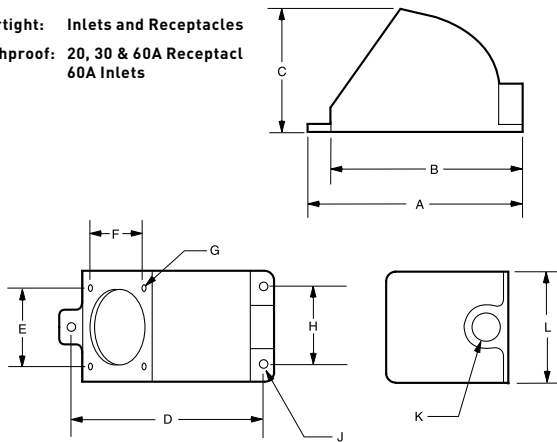

Splashproof: 20 & 30A Inlets

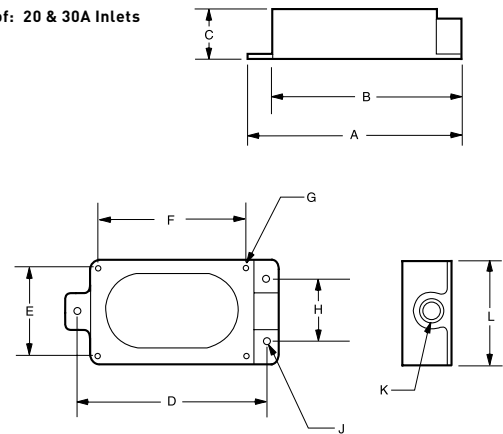

Non-Metallic Back Boxes Dimensions

Catalog Number	A	B	C	D	E	Hub Size
PSBBN201W	2.50	2.31	4.16	2.28	0.78	3/4" NPT
PSBBN202W	3.34	3.78	4.81	2.38	0.63	3/4" NPT
PSBBN301W	3.53	4.03	6.38	3.53	1.03	1" NPT
PSBBN601W	6.00	6.69	11.81	5.91	1.56	1 1/2" NPT

All measurements shown in inches.



In both non-metallic (left) and metallic (right) Back Boxes, you'll find easy installation and no-compromises durability.

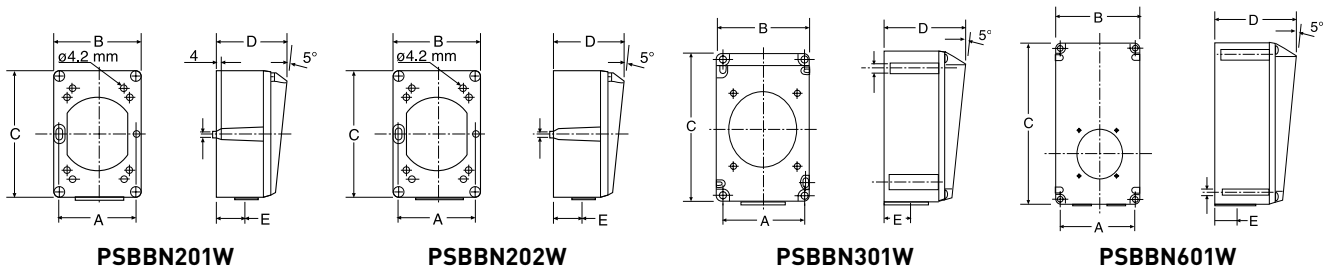

PIN & SLEEVE DEVICES

Accessories/Dimensional Information

Pin & Sleeve Strain Relief Adapters

Catalog Number	A	B	C	D	E	F	G	H (Metric Thread)
PSAD3050	1/2" NPT	1.38	1.13	.54	.25	.47	.88	M32X1.5
PSAD3034	3/4" NPT	1.50	1.50	.56	.25	.47	.88	M32X1.5
PSAD301	1" NPT	1.75	1.75	.70	.25	.47	.88	M32X1.5
PSAD601	1" NPT	2.00	1.75	.70	.38	1.00	1.38	M45X2
PSAD60125	1 1/4" NPT	2.00	2.00	.70	.38	1.00	1.38	M45X2
PSAD60150	1 1/2" NPT	2.38	2.38	.70	.38	1.00	1.38	M45X2
PSAD100125	1 1/4" NPT	2.50	2.38	.70	.38	1.10	2.00	M60X2
PSAD100150	1 1/2" NPT	2.50	2.38	.70	.38	1.10	2.00	M60X2
PSAD1002	2" NPT	2.75	2.70	.75	.38	1.10	2.00	M60X2

All measurements shown in inches.

Back Box & Protective Covers

Device Type	Back Box	Hub Size	Protective Plug & Inlet Cover
20A 3 Wire	PSBB201W	1/2"	PSCP320
20A 4 Wire	PSBB202W	3/4"	PSCP420
20A 5 Wire	PSBB202W	3/4"	PSCP520
20A 3, 4, 5 Wire (Inlet)	PSBB201SP	3/4"	Use as required
30A 3, 4 Wire	PSBB301W	3/4"	PSCP3430
30A 5 Wire	PSBB301W	3/4"	PSCP530
30A 3, 4, 5 Wire (Inlet)	PSBB301SP	3/4"	Use as required
All 60A	PSBB601W*	1 1/2"	PSCP60
All 100A	PSBB1001W	1 1/2"	PSCP100
All 100A	PSBB1002W	2"	PSCP100

*11/4" Reducer Supplied

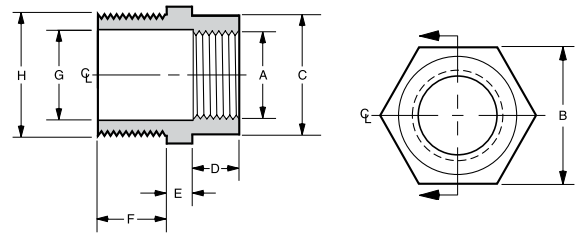

PSCP320

PSCP60

Strain Relief Adapter Fittings

Device Type	Fitting Size	Catalog Number
20A 3, 4 Wire	1/2" NPT	PSAD2050
20A 3, 4 Wire	3/4" NPT	PSAD2034
20A 5W, All 30A	1/2" NPT	PSAD3050
30A 3, 4 Wire	3/4" NPT	PSAD3034
30A 3, 4 Wire	1" NPT	PSAD301
All 60A	1" NPT	PSAD601
All 60A	1 1/4" NPT	PSAD60125
All 60A	1 1/2" NPT	PSAD60150
All 100A	1 1/4" NPT	PSAD100125
All 100A	1 1/2" NPT	PSAD100150
All 100A	2" NPT	PSAD1002



Choose from a full range of P&S Strain Relief Adapters, all built extra-tough for no-worries dependability.

PIN & SLEEVE DEVICES

Technical Specifications

Watertight Pin & Sleeve Plugs

20, 30, 60 & 100A

Typical Specifications

- Manufacturer's Identification: Pass & Seymour PS460P7W
- Description: Plug, Power Supply
- Type: 3 Pole, 4 Wire Grounding
- Rating: 60A, 3 Phase 480VAC
- Configuration: IEC 309-2, Clock Position 7, Watertight (IP67)
- 3rd Party Compliance: UL Listed to UL Standard 1682; CSA Certified to CSA 22.2 No. 182.2; UL Classified to IEC 309-1 and IEC 309-2

Watertight Pin & Sleeve Connectors

20, 30, 60 & 100A

Typical Specifications

- Manufacturer's Identification: Pass & Seymour PS460C7W
- Description: Connector, Power Supply
- Type: 3 Pole, 4 Wire Grounding
- Rating: 60A, 3 Phase 480VAC
- Configuration: IEC 309-2, Clock Position 7, Watertight (IP67)
- 3rd Party Compliance: UL Listed to UL Standard 1682; CSA Certified to CSA 22.2 No. 182.2; UL Classified to IEC 309-1 and IEC 309-2

Splashproof Pin & Sleeve Plugs

20, 30 & 60A

Typical Specifications

- Manufacturer's Identification: Pass & Seymour PS460P7S
- Description: Plug, Power Supply
- Type: 3 Pole, 4 Wire Grounding
- Rating: 60A, 3 Phase 480VAC
- Configuration: IEC 309-2, Clock Position 7, Splashproof (IP44)
- 3rd Party Compliance: UL Listed to UL Standard 1682; CSA Certified to CSA 22.2 No. 182.2; UL Classified to IEC 309-1 and IEC 309-2

Splashproof Pin & Sleeve Connectors

20, 30 & 60A

Typical Specifications

- Manufacturer's Identification: Pass & Seymour PS460C7S
- Description: Connector, Power Supply
- Type: 3 Pole, 4 Wire Grounding
- Rating: 60A, 3 Phase 480VAC
- Configuration: IEC 309-2, Clock Position 7, Splashproof (IP44)
- 3rd Party Compliance: UL Listed to UL Standard 1682; CSA Certified to CSA 22.2 No. 182.2; UL Classified to IEC 309-1 and IEC 309-2

PIN & SLEEVE DEVICES

Technical Specifications

IP Suitability Rating

IEC Enclosure Classification Designation

IP Suitability Ratings are an international system for classifying the degree of protection provided by enclosures of electrical equipment. The higher the number, the greater the degree of protection; they apply ONLY to properly installed equipment. The numerals stand for the following:

- 1. First Number:** Degree of protection for persons against access to hazardous parts inside the enclosure and/or against solid bodies.
- 2. Second Number:** Degree of protection of equipment inside enclosures against damage from the ingress of water.

IEC Enclosure Classification Designation		
Code Letters	First Number	Second Number
Ingress Protection	Against Ingress of Solid Bodies	Against Ingress of Water with Harmful Effects
IP	0 - Nonprotected	0 - Nonprotected
	1 - \geq 50 mm diameter	1 - Vertically dripping
	2 - \geq 12.5 mm diameter	2 - Dripping (15° Tilted)
	3 - \geq 2.5 mm diameter	3 - Spraying
	4 - \geq 1.0 mm	4 - Splashing
	5 - Dust-protected	5 - Jetting
	6 - Dusttight	6 - Power jetting
		7 - Temporary immersion
	8 - Continuous immersion	

Note: \geq denotes greater than or equal to. Dimensions in millimeters (mm).

Example: **IP44** = Ingress Protection; Solid bodies \geq 1.0 mm; Splashing

IP44
Suitability

Conversion Chart

Fractions to Decimals to Millimeters

Inches Fraction	Decimal	mm	Inches Fraction	Decimal	mm	Inches Fraction	Decimal	mm	Inches Fraction	Decimal	mm
1/64	0.0156	0.3969	17/64	0.2656	6.7469	33/64	0.5156	13.0969	49/64	0.7656	19.4469
1/32	0.0312	0.7938	9/32	0.2812	7.1438	17/32	0.5312	13.4938	25/32	0.7812	19.8437
3/64	0.0468	1.1906	19/64	0.2968	7.5406	35/64	0.5468	13.8906	51/64	0.7968	20.2406
1/16	0.0625	1.5875	5/16	0.3125	7.9375	9/16	0.5625	14.2875	13/16	0.8125	20.6375
5/64	0.0781	1.9844	21/64	0.3281	8.3344	37/64	0.5781	14.6844	53/64	0.8281	21.0344
3/32	0.0937	2.3812	11/32	0.3437	8.7312	19/32	0.5937	15.0812	27/32	0.8437	21.4312
7/64	0.1093	2.7781	23/64	0.3593	9.1281	39/64	0.6093	15.4781	55/64	0.8593	21.8281
1/8	0.1250	3.1750	3/8	0.3750	9.5250	5/8	0.6250	15.8750	7/8	0.8750	22.2250
9/64	0.1406	3.5719	25/64	0.3906	9.9219	41/64	0.6406	16.2719	57/64	0.8906	22.6219
5/32	0.1562	3.9688	13/32	0.4062	10.3188	21/32	0.6562	16.6688	29/32	0.9062	23.0188
11/64	0.1718	4.3656	27/64	0.4218	10.7156	43/64	0.6718	17.0656	59/64	0.9218	23.4156
3/16	0.1875	4.7625	7/16	0.4375	11.1125	11/16	0.6875	17.4625	15/16	0.9375	23.8125
13/64	0.2031	5.1594	29/64	0.4531	11.5094	45/64	0.7031	17.8594	61/64	0.9531	24.2094
7/32	0.2187	5.5562	15/32	0.4687	11.9062	23/32	0.7187	18.2562	31/32	0.9687	24.6062
15/64	0.2343	5.9531	31/64	0.4843	12.3031	47/64	0.7343	18.6531	63/64	0.9843	25.0031
1/4	0.2500	6.3500	1/2	0.5000	12.7000	3/4	0.7500	19.0500	1	1.0000	25.4000

PIN & SLEEVE DEVICES

Product Selection Guide

North American Watertight

Pg. M-7-11	Pg. M-12-16	Amps	Volts	Pg. J-4-8	Pg. J-9-13	Pg. J-16-17				Pg. J-16-17	
Fusible Safety Switches	Non-Fusible Safety Switches			Fusible Mech. Interlock	Non-Fusible Mech. Interlock	Plug	Receptacle	Connector	Inlet	Metallic Back Box	Non-Metallic Back Box
N/A	N/A	20	120VAC			PS320P4W	PS320R4W	PS320C4W		PSBB201W	PSBBN201W
			240VAC			PS320P6W	PS320R6W	PS320C6W		PSBB201W	PSBBN201W
			480VAC			PS320P7W	PS320R7W	PS320C7W		PSBB201W	PSBBN201W
			277VAC			PS320P5W	PS320R5W	PS320C5W		PSBB201W	PSBBN201W
			120/240VAC	PS420FMIR12W	PS420MIR12W	PS420P12W	PS420R12W	PS420C12W		PSBB202W	PSBBN202W
			3ø 240VAC	PS420FMIR9W	PS420MIR9W	PS420P9W	PS420R9W	PS420C9W		PSBB202W	PSBBN202W
			3ø 480VAC	PS420FMIR7W	PS420MIR7W	PS420P7W	PS420R7W	PS420C7W		PSBB202W	PSBBN202W
			3ø 600VAC	PS420FMIR5W	PS420MIR5W	PS420P5W	PS420R5W	PS420C5W		PSBB202W	PSBBN202W
			3øY 120/208VAC			PS520P9W	PS520R9W	PS520C9W		PSBB202W	PSBBN202W
			3øY 277/480VAC			PS520P7W	PS520R7W	PS520C7W		PSBB202W	PSBBN202W
			3øY 347/600VAC			PS520P5W	PS520R5W	PS520C5W		PSBB202W	PSBBN202W
PS30FSS	PS30SS	30	120VAC		PS330MIR4W	PS330P4W	PS330R4W	PS330C4W		PSBB301W	PSBBN301W
			240VAC	PS330FMIR6W		PS330P6W	PS330R6W	PS330C6W		PSBB301W	PSBBN301W
			480VAC			PS330P7W	PS330R7W	PS330C7W		PSBB301W	PSBBN301W
			120/240VAC	PS430FMIR12W			PS430R12W	PS430C12W		PSBB301W	PSBBN301W
			3ø 240VAC	PS430FMIR9W	PS430MIR9W	PS430P9W	PS430R9W	PS430C9W		PSBB301W	PSBBN301W
			3ø 480VAC	PS430FMIR7W	PS430MIR7W	PS430P7W	PS430R7W	PS430C7W		PSBB301W	PSBBN301W
			3ø 600VAC	PS430FMIR5W	PS430MIR5W	PS430P5W	PS430R5W	PS430C5W		PSBB301W	PSBBN301W
			380/440 VAC	PS430FMIR3W	PS430MIR3W	PS430P3W	PS430R3W	PS430C3W		PSBB301W	PSBBN301W
			3øY 120/208VAC	PS530FMIR9W	PS530MIR9W	PS530P9W	PS530R9W	PS530C9W		PSBB301W	PSBBN301W
			3øY 277/480VAC	PS530FMIR7W	PS530MIR7W	PS530P7W	PS530R7W	PS530C7W		PSBB301W	PSBBN301W
			3øY 347/600VAC		PS530MIR5W		PS530R5W	PS530C5W		PSBB301W	PSBBN301W
PS60FSS	PS60SS	60	120VAC			PS360P4W	PS360R4W	PS360C4W	PS360B4W	PSBB601W	PSBBN601W
			240VAC	PS360FMIR6W	PS360MIR6W	PS360P6W	PS360R6W	PS360C6W	PS360B6W	PSBB601W	PSBBN601W
			480VAC		PS360MIR7W	PS360P7W	PS360R7W	PS360C7W		PSBB601W	PSBBN601W
			120/240VAC	PS460FMIR12W	PS460MIR12W	PS460P12W	PS460R12W	PS460C12W	PS460B12W	PSBB601W	PSBBN601W
			3ø 240VAC	PS460FMIR9W	PS460MIR9W	PS460P9W	PS460R9W	PS460C9W	PS460B9W	PSBB601W	PSBBN601W
			3ø 480VAC	PS460FMIR7W	PS460MIR7W	PS460P7W	PS460R7W	PS460C7W	PS460B7W	PSBB601W	PSBBN601W
			3ø 600VAC	PS460FMIR5W	PS460MIR5W	PS460P5W	PS460R5W	PS460C5W	PS460B5W	PSBB601W	PSBBN601W
			3øY 120/208VAC	PS560FMIR9W	PS560MIR9W	PS560P9W	PS560R9W	PS560C9W	PS560B9W	PSBB601W	PSBBN601W
			3øY 277/480VAC	PS560FMIR7W	PS560MIR7W	PS560P7W	PS560R7W	PS560C7W	PS560B7W	PSBB601W	PSBBN601W
			3øY 347/600VAC	PS560FMIR5W	PS560MIR5W	PS560P5W	PS560R5W	PS560C5W	PS560B5W	PSBB601W	PSBBN601W
			PS100FSS	PS100SS	100	120VAC			PS3100P4W	PS3100R4W	PS3100C4W
240VAC		PS3100MIR6W				PS3100P6W	PS3100R6W	PS3100C6W	PS3100B6W	PSBB1001W	
480VAC		PS3100MIR7W				PS3100P7W	PS3100R7W	PS3100C7W	PS3100B7W	PSBB1001W	
120/240VAC	PS4100FMIR12W	PS4100MIR12W				PS4100P12W	PS4100R12W	PS4100C12W	PS4100B12W	PSBB1001W	
3ø 240VAC	PS4100FMIR9W	PS4100MIR9W				PS4100P9W	PS4100R9W	PS4100C9W	PS4100B9W	PSBB1001W	
3ø 480VAC	PS4100FMIR7W	PS4100MIR7W				PS4100P7W	PS4100R7W	PS4100C7W	PS4100B7W	PSBB1001W	
3ø 600VAC	PS4100FMIR5W	PS4100MIR5W				PS4100P5W	PS4100R5W	PS4100C5W	PS4100B5W	PSBB1001W	
3øY 120/208VAC	PS5100FMIR9W	PS5100MIR9W				PS5100P9W	PS5100R9W	PS5100C9W	PS5100B9W	PSBB1001W	
3øY 277/480VAC	PS5100FMIR7W	PS5100MIR7W				PS5100P7W	PS5100R7W	PS5100C7W	PS5100B7W	PSBB1001W	
3øY 347/600VAC	PS5100FMIR5W	PS5100MIR5W				PS5100P5W	PS5100R5W	PS5100C5W	PS5100B5W	PSBB1001W	

PIN & SLEEVE DEVICES

Product Selection Guide

North American Splashproof

Amps	Volts	Pg. J-18				Pg. J-18	
		Plug	Receptacle	Connector	Inlet	Metallic Back Box	Non-Metallic Back Box
20	120VAC	PS320P4S		PS320C4S		PSBB201W	PSBBN201W
	240VAC	PS320P6S	PS320R6S	PS320C6S	PS320B6S	PSBB201W	PSBBN201W
	277VAC	PS320P5S	PS320R5S			PSBB201W	PSBBN201W
	120/240VAC	PS420P12S	PS420R12S	PS420C12S		PSBB202W	PSBBN202W
	3ø 240VAC	PS420P9S	PS420R9S	PS420C9S	PS420B9S	PSBB202W	PSBBN202W
	3ø 480VAC	PS420P7S	PS420R7S	PS420C7S	PS420B7S	PSBB202W	PSBBN202W
	3ø 600VAC		PS420R5S		PS420B5S	PSBB202W	PSBBN202W
	3øY 120/208VAC		PS520R9S	PS520C9S	PS520B9S	PSBB202W	PSBBN202W
	3øY 277/480VAC			PS520C7S	PS520B7S	PSBB202W	PSBBN202W
	3øY 347/600VAC		PS520R5S	PS520C5S	PS520B5S	PSBB202W	PSBBN202W
30	120VAC	PS330P4S	PS330R4S	PS330C4S	PS330B4S	PSBB301W	PSBBN301W
	240VAC	PS330P6S	PS330R6S	PS330C6S	PS330B6S	PSBB301W	PSBBN301W
	480VAC	PS330P7S		PS330C7S	PS330B7S	PSBB301W	PSBBN301W
	120/240VAC		PS430R12S	PS430C12S	PS430B12S	PSBB301W	PSBBN301W
	3ø 240VAC	PS430P9S	PS430R9S	PS430C9S	PS430B9S	PSBB301W	PSBBN301W
	3ø 480VAC	PS430P7S	PS430R7S	PS430C7S	PS430B7S	PSBB301W	PSBBN301W
	3ø 600VAC	PS430P5S	PS430R5S	PS430C5S	PS430B5S	PSBB301W	PSBBN301W
	3øY 120/208VAC	PS530P9S	PS530R9S	PS530C9S	PS530B9S	PSBB301W	PSBBN301W
	3øY 277/480VAC	PS530P7S			PS530B7S	PSBB301W	PSBBN301W
	3øY 347/600VAC	PS530P5S	PS530R5S	PS530C5S	PS530B5S	PSBB301W	PSBBN301W
60	240VAC	PS360P6S	PS360R6S	PS360C6S	PS360B6S	PSBB601W	PSBBN601W
	480VAC	PS360P7S	PS360R7S	PS360C7S	PS360B7S	PSBB601W	PSBBN601W
	120/240VAC	PS460P12S	PS460R12S	PS460C12S	PS460B12S	PSBB601W	PSBBN601W
	3ø 240VAC	PS460P9S	PS460R9S	PS460C9S	PS460B9S	PSBB601W	PSBBN601W
	3ø 480VAC	PS460P7S	PS460R7S	PS460C7S	PS460B7S	PSBB601W	PSBBN601W
	3ø 600VAC	PS460P5S	PS460R5S	PS460C5S	PS460B5S	PSBB601W	PSBBN601W
	3øY 120/208VAC	PS560P9S	PS560R9S	PS560C9S	PS560B9S	PSBB601W	PSBBN601W
	3øY 277/480VAC	PS560P7S	PS560R7S	PS560C7S	PS560B7S	PSBB601W	PSBBN601W
	3øY 347/600VAC	PS560P5S	PS560R5S	PS560C5S	PS560B5S	PSBB601W	PSBBN601W

PIN & SLEEVE DEVICES

Product Selection Guide

International Splashproof

Amps	Volts	Pg. J-19				Pg. J-19
		Receptacle	Plug	Connector	Inlet	Non-Metallic Back Box
16	110/120	51920	51940	51980	51970	52029
	220/240	52022	52042	52082	52172	52029
	380/415	52222	52242	52282	52272	52029
	220/240	52023	52043	52083	52073	52229
	380/415	52223	52243	52283		52229
	220/240		52044	52084	52074	52229
	220/380; 240/415	52224	52244	52284	52174	52229
32	110/120				51972	
	220/240	52718	52742	52782	52872	
	380/415		52942	52982	52972	
	220/240		52743	52783	52773	
	380/415		52943	52983	52873	
	220/240		52744		52774	
	220/380; 240/415		52944	52984		
63	110/120	53542	53582			53889
	220/240	53622	53642	53682	53772	53889
	220/240	53623	53643	53683		53889
	380/415	53823	53843	53883	53773	53889
	220/240		53644	53684		53889
	220/380; 240/415	53824	53844	53884	53774	53889

P17 TEMPRA PRO, always ensuring continuity of service

By updating its IP44 and IP 66/67 range of industrial sockets, Legrand is meeting the expectations of professional users. New benefits in terms of safety, implementation, design & ergonomics guarantee the longevity of this family of products, which has already proven itself over time.



IP44

SOCKETS FOR INTERNAL AND EXTERNAL USE, PROTECTED AGAINST PROJECTIONS OF WATER (BUT NOT EXPOSED TO DIRECT JETS)



Straight plugs



Mobile sockets



Panel mounting sockets

A TRANSFORMED RANGE
WHICH HARMONIZES
WITH THE LEGRAND
INDUSTRIAL SOCKETS
RANGE

- From 16 to 32 A
- 2 P+ E / 3 P+E / 3 P+N+E
- From 100 to 500 VA
- 50/60 Hz
- Screw connection



AIRPORTS, DATA CENTERS,
HOTELS, ETC. P17 TEMPRA PRO
IS IDEAL FOR ALL MAJOR
PROJECTS

IP66/67

WEATHERPROOF SOCKETS THAT CAN
WITHSTAND TEMPORARY IMMERSION
(RAIN, FLOODS, ETC)



Surface mounting
sockets



Straight plugs



Mobile sockets



Panel mounting
sockets



Surface mounting
sockets

P17 TEMPRA PRO, ensuring a quick installation

As competitiveness is key to success when working on a site, the P17 Tempra Pro range offers an array of essential and intuitive benefits aimed at simplifying every movement, freeing up wiring space and ensuring quick, accurate cable connection under optimum conditions.

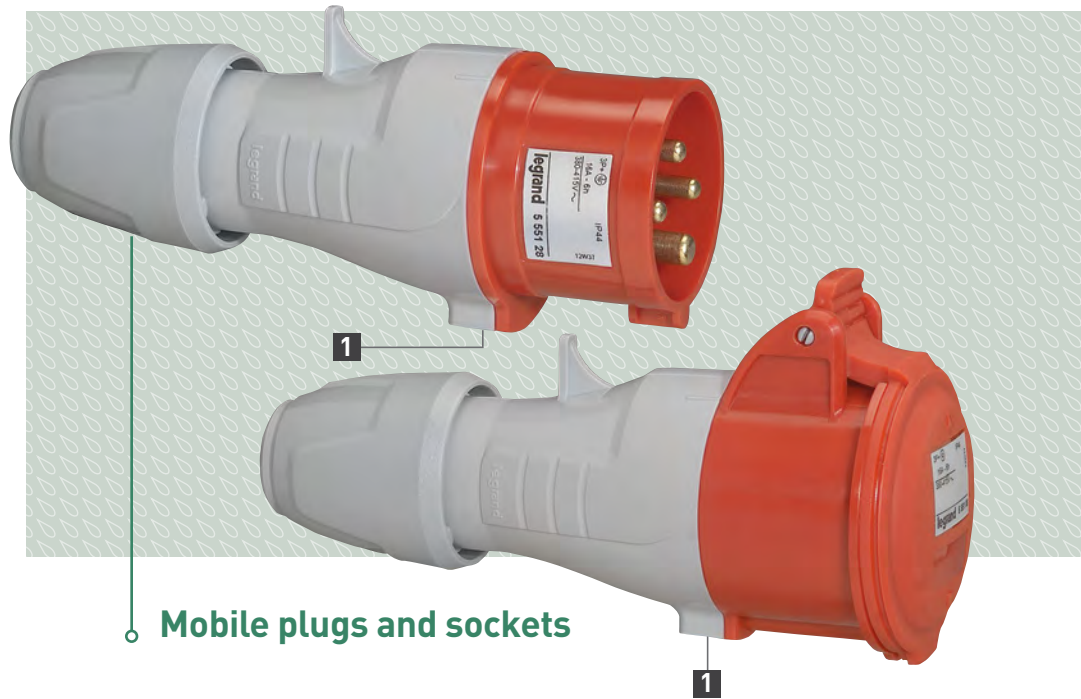

Mobile plugs and sockets

IEC 309 INDUSTRIAL PRODUCTS

MOBILE PRODUCTS
ARE SUPPLIED
ASSEMBLED AND
UNLOCKED



1 QUICK OPENING/CLOSING SYSTEM

Unlocked by pressing with a screwdriver. Marking indicates the location for the locking clip.



Opened by turning the 2 parts in opposite directions.



2 CABLE STRIPPING

Marking allows the user to see quickly the length of cable to be stripped. Option of using cables with ferrules.

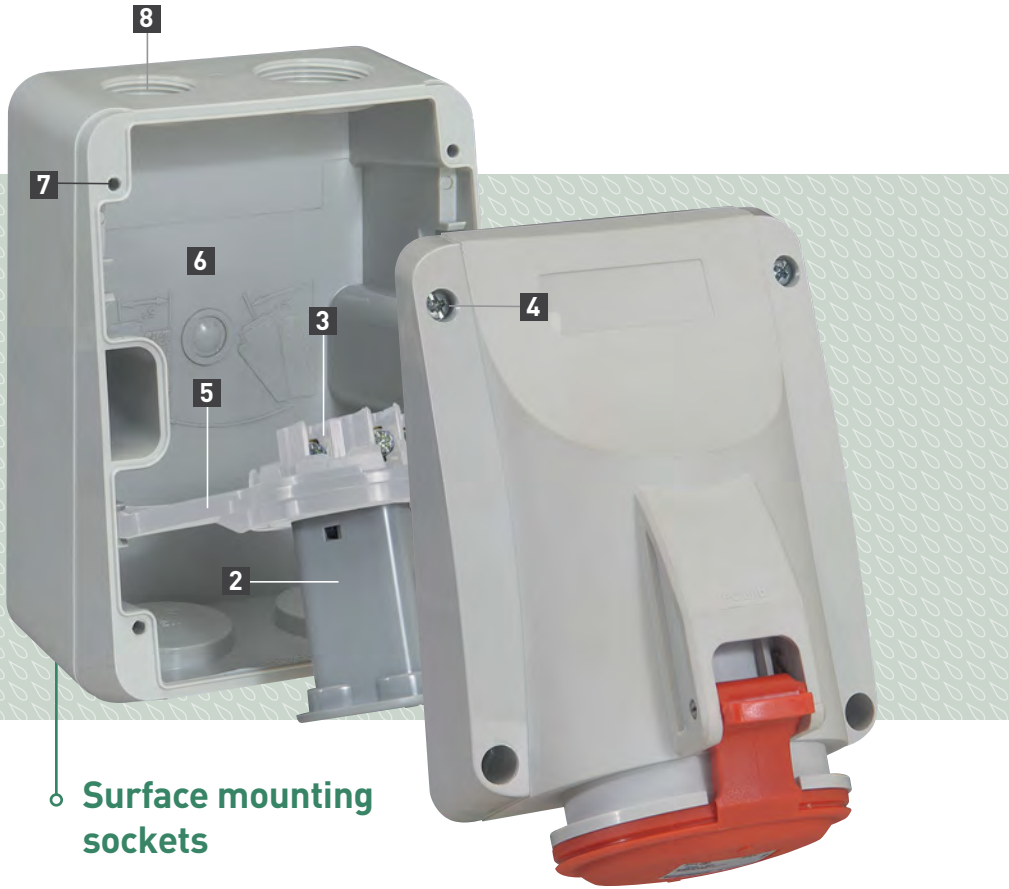

Surface mounting sockets



8 CABLE ENTRIES

4 threaded and sealed cable entries at the top and the bottom and marking at the back of the box for ISO cable glands or conduits.

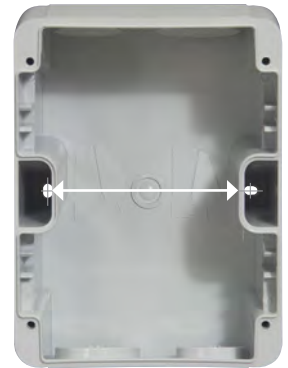

7 EASIER MAINTENANCE

Fixing centers are identical to the old range (70 mm) for the 16 A sockets and marked at the back of the box for 32 A sockets.



3 JUST ONE SCREW PER TERMINAL

A single captive PZ 2 screw, per connection terminal. Same type of screw for both ratings, 16 and 32 A.



4 EASY COVER FIXING

Stainless steel captive screws with mixed head (for cross or flat screwdriver) for a good seal and anti-corrosion resistance.

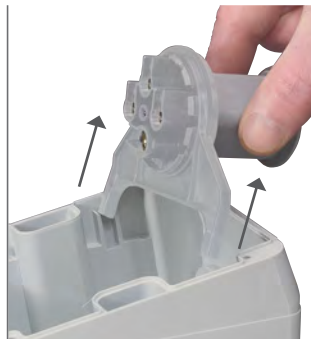

5 EASY REMOVAL

The active parts of the product can be removed from the base for easier wiring and changing the socket angle.

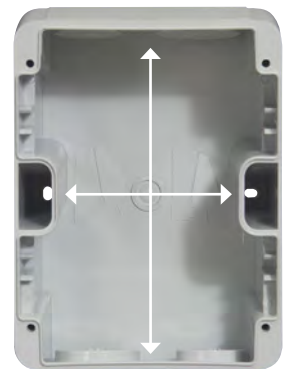

6 EASY WIRING

Optimum wiring area for easier connections.

P17 TEMPRA PRO,

ensuring ease of use and safety

The new P17 Tempra Pro range has been subject to extensive research in terms of design and safety in order to make life safer and easier for the user. Good product gripping, compact dimensions for use in tight spaces, easier handling, etc. Compliance with standards, anti-corrosion treated materials and components, etc. A comprehensive set of solutions which comply with the standards.



IEC 309 INDUSTRIAL PRODUCTS

AN INNOVATIVE DESIGN THAT COMPLIES WITH STANDARDS IEC 60309-1 AND 2 AND RESPECTS THE ENVIRONMENT

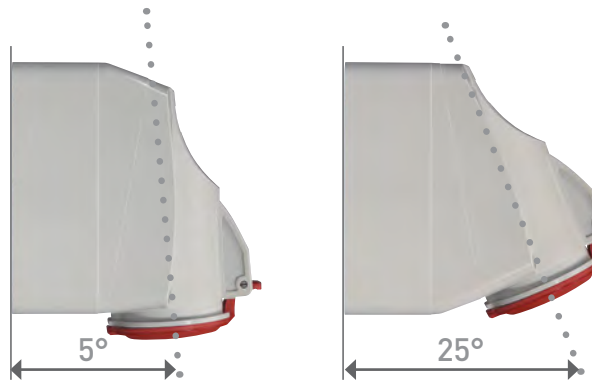

1 2 MOUNTING POSITIONS

To solve the problem of limited space, the surface mounting sockets offer 2 different mounting positions (5° or 25°) which allow users to adapt to the space available without changing the box.



2 CABLE GRIP

Captive cable grip with anti-vibration system holds the cable in place permanently.

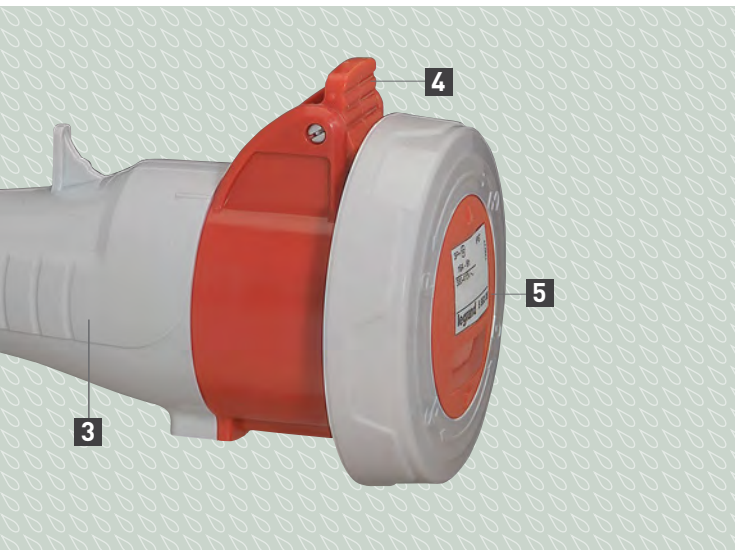

SAFETY & THE ENVIRONMENT

SAFETY

Connection terminals compliant with standards IEC 60 309 1 & 2

Production sites certified according to ISO 14001 and ISO 9001

Very high resistance to chemical products. Plugs and sockets made of polyamide 6

Anti-corrosion treated screws, stainless steel springs for the socket covers

Resistant to temperatures of -25°C to +40°C

ENVIRONMENT

Halogen-free recyclable materials (silicone, PVC)

Grouped packaging in boxes

PEP products (Eco Passport)



3 EASE OF HANDLING

Gripping areas on the body of the mobile products and the cable grip.



4 OPENING LEVER

For easier connection/disconnection. Cover held open on panel sockets and surface mounting sockets.



5 POSITION MARKING

Information engraved on the ring cover of IP66/67 products means the user can check quickly whether it is in the open or closed position. Marking area on the shutter of the sockets and on the upper part of the plugs allows easy identification by the user.

PIN & SLEEVE DEVICES

P 17 Tempra Pro IP 44 - LV 16 and 32 A

			FUNCTIONS							
			SURFACE MOUNTING SOCKETS	PANEL MOUNTING SOCKETS INCLINED OUTLET	PANEL MOUNTING SOCKETS STRAIGHT OUTLET	INTERLOCKED SWITCHED SOCKETS WITH SMALL FLANGE	MOBILE SOCKETS	STRAIGHT PLUGS	ANGLED PLUG	APPLIANCE INLETS
Conform to IEC 60309-1 and IEC 60309-2 IP 44 according to IEC 60529 IK 09 according to IEC 62262 Material: polyamide 6 Self-extinguishing: 850 °C (support of active parts) / 650 °C (plastic housing)										
LV										
100 to 130 VA 50/60 Hz	16 A	2P+E	5 551 51	5 551 81	0 573 51		5 551 01	5 551 21		0 575 81 ⁽²⁾
		3P+E	5 551 52				5 551 02	5 551 22		
	32 A	2P+E	5 552 51	5 552 81			5 552 11	5 552 31		0 582 81 ⁽²⁾
200 to 250 VA 50/60 Hz	16 A	2P+E	5 551 54	5 551 84	0 573 54	0 573 00 ⁽¹⁾	5 551 04	5 551 24	0 564 53	0 575 84 ⁽²⁾
		3P+E	5 551 55	5 551 85			5 551 05	5 551 25		0 575 85 ⁽²⁾
		3P+N+E	5 551 56	5 551 86			5 551 06	5 551 26		0 575 86 ⁽²⁾
	32 A	2P+E	5 552 54	5 552 84	0 580 54		5 552 14	5 552 34	0 564 73	0 582 84 ⁽²⁾
		3P+E	5 552 55	5 552 85			5 552 15	5 552 35		
		3P+N+E	5 552 56	5 552 86			5 552 16	5 552 36		0 582 86 ⁽²⁾
380 to 415 VA 50/60 Hz	16 A	2P+E	5 551 57				5 551 07	5 551 27		
		3P+E	5 551 58	5 551 88	0 573 58	0 573 01 ⁽¹⁾	5 551 08	5 551 28	0 564 57	0 575 88 ⁽²⁾
		3P+N+E	5 551 59		0 573 59	0 573 02 ⁽¹⁾	5 551 09	5 551 29	0 564 58	0 575 89 ⁽²⁾
	32 A	2P+E	5 552 57				5 552 17	5 552 37		
		3P+E	5 552 58	5 552 88	0 580 58		5 552 18	5 552 38	0 564 77	0 582 88 ⁽²⁾
		3P+N+E	5 552 59	5 552 89	0 580 59		5 552 19	5 552 39	0 564 78	0 582 89 ⁽²⁾
440 to 460 VA 50/60 Hz	16 A	3P+E	5 551 60	5 551 90			5 551 10	5 551 30		
	32 A	3P+E	5 552 60	5 552 90			5 552 20	5 552 40		
480 to 500 VA 50/60 Hz	16 A	3P+E	5 551 62	5 551 92			5 551 12	5 551 32		
		3P+N+E	5 551 63	5 551 93			5 551 13	5 551 33		
	32 A	3P+E	5 552 62	5 552 92			5 552 22	5 552 42		
		3P+N+E	5 552 63	5 552 93			5 552 23	5 552 43		

PIN & SLEEVE DEVICES

P 17 Tempra Pro IP 66/67 - LV 16, 32, 63 and 125 A

Conform to IEC 60309-1 and IEC 60309-2 IP 44 according to IEC 60529 IK 09 according to IEC 62262 Material: polyamide 6 Self-extinguishing: 850 °C (support of active parts) / 650 °C (plastic housing)			FUNCTIONS						
			SURFACE MOUNTING SOCKETS	PANEL MOUNTING SOCKETS	INTERLOCKED SWITCHED SOCKETS WITH SMALL FLANGE	MOBILE SOCKETS	STRAIGHT PLUGS	ANGLED PLUG	APPLIANCE INLETS
LV									
100 to 130 VA 50/60 Hz	16 A	2P+E	5 553 51	5 553 81		5 553 01	5 553 21		0 568 00
	32 A	2P+E	5 554 51	5 554 81			5 554 31		
200 to 250 VA 50/60 Hz	16 A	2P+E	5 553 54	5 553 84	0 573 20 ⁽¹⁾⁽²⁾	5 553 04	5 553 24	0 565 03	0 568 03
		3P+E	5 553 55	5 553 85		5 553 05	5 553 25		0 568 04
		3P+N+E	5 553 56	5 553 86		5 553 06	5 553 26		
	32 A	2P+E	5 554 54	5 554 84		5 554 14	5 554 34	0 565 23	0 568 23
		3P+E	5 554 55	5 554 85		5 554 15	5 554 35		
		3P+N+E	5 554 56	5 554 86		5 554 16	5 554 36		
	63 A	2P+E	0 587 40	0 587 20		0 587 10	0 587 00		0 587 30
		3P+E	0 587 41	0 587 21		0 587 11	0 587 01		
		3P+N+E	0 587 42	0 587 22		0 587 12	0 587 02		
380 to 415 VA 50/60 Hz	16 A	3P+E	5 553 58	5 553 88	0 573 21 ⁽¹⁾⁽²⁾	5 553 08	5 553 28		0 568 07
		3P+N+E	5 553 59	5 553 89	0 573 22 ⁽¹⁾⁽²⁾	5 553 09	5 553 29		0 568 08
	32 A	3P+E	5 554 58	5 554 88		5 554 18	5 554 38		0 568 27
		3P+N+E	5 554 59	5 554 89		5 554 19	5 554 39	0 565 28	0 568 28
	63 A	3P+E	0 587 44	0 587 24		0 587 14	0 587 04		0 587 34
		3P+N+E	0 587 45	0 587 25		0 587 15	0 587 05		0 587 35
	125 A	3P+E	0 591 06	0 591 16		0 591 36	0 591 26		0 591 46
		3P+N+E	0 591 07	0 591 17		0 591 37	0 591 27		0 591 47
	440 VA 50/60 Hz for refrigerated containers	32 A	3P+E		5 554 91		5 554 21	5 554 41	
480 to 500 VA 50/60 Hz	16 A	3P+E	5 553 62	5 553 92		5 553 12	5 553 32		
	32 A	3P+E	5 554 62	5 554 92		5 554 22	5 554 42		
		3P+N+E	5 554 63				5 554 43		
63 A	3P+E	0 553 48	0 587 27		0 587 17	0 587 07			

PIN & SLEEVE DEVICES

P 17 Tempra Pro IP 44 - LV 16 and 32 A

Characteristics

Terminal connection:

- Panel and surface mounting sockets:
16 A: max. 1 x 4 mm² rigid 32 A: max. 1 x 10 mm² rigid
- Appliance inlets:
16 A: max. 1 x 2.5 mm² rigid 32 A: max. 1 x 6 mm² rigid
- Plugs and mobile sockets:
16 A: max. 1 x 2.5 mm² flexible 32 A: max. 1 x 6 mm² flexible

IP 44 according to IEC and EN 60529

IK 08 according to EN 50102 for interlocked switched sockets with small flange

IK 09 according to IEC 62262 and EN 62262

Material: polyamide 6

Self-extinguishing: 850 °C (support of active parts) / 650 °C (plastic housing)

- 25 °C to + 40 °C according to IEC 60309-1

Dimensions

Surface mounting sockets

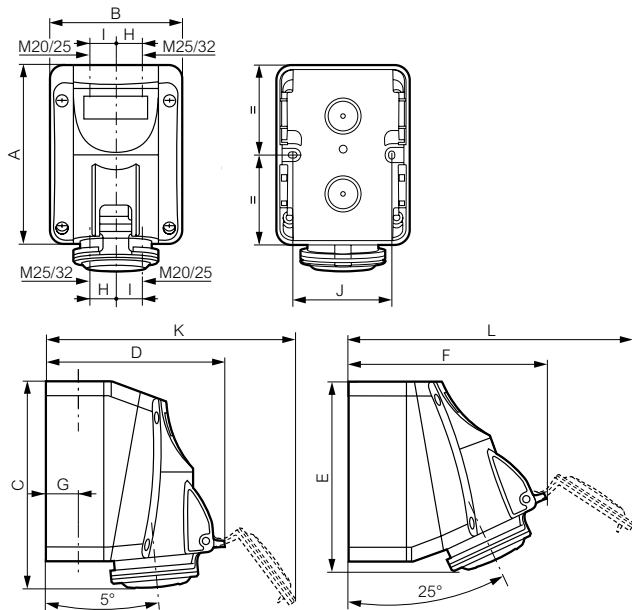

	A	B	C	D	E	F	G	H	I	J	K	L
LV 16 A												
2P+E	125	93	147	126	138	139	22	17	20	70	176	195
3P+E	125	93	147	134	138	147	22	17	20	70	190	210
3P+N+E	125	93	147	140	138	153	22	17	20	70	201	221
LV 32 A												
2P+E	150	113	174	156	163	172	28	22	26	90	220	245
3P+E	150	113	174	156	163	172	28	22	26	90	220	245
3P+N+E	150	113	174	162	163	177	28	22	26	90	230	256

Panel mounting socket straight outlet small flange

Cat.No 0 573 54

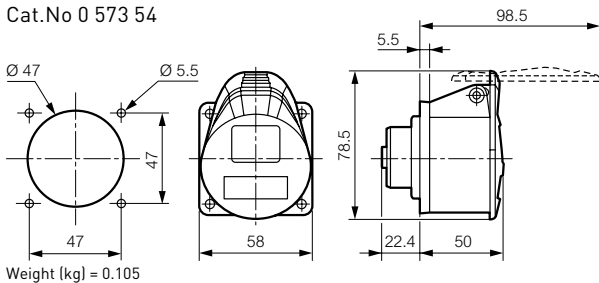

Weight (kg) = 0.105

Panel mounting sockets inclined outlet

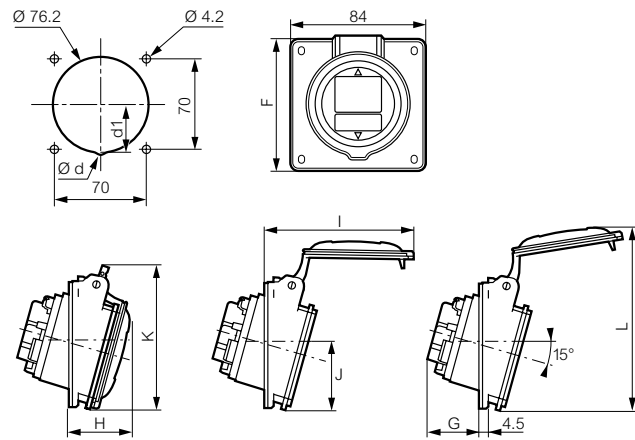

	Ød	d1	F	G	H	I	J	K	L
LV 16 A									
2P+E	-	-	84	33.5	37.5	85	42	88.5	112.5
3P+E	-	-	84	35.5	38.5	93	42	91.5	118.5
3P+N+E	-	-	84	36.5	39.5	100	43.3	97	123.5
LV 32 A									
2P+E	-	-	94	41.5	45.5	110	47	102	131
3P+E	-	-	94	42.5	46.5	117	47	107.5	138

Appliance inlets

Cat.Nos 0 575 84/88/89 and 0 582 84/88/89

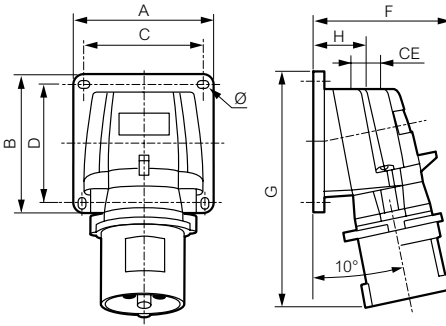

	Weight (kg)	A	B	C	D	F	G	H	CE	Ø
LV 16 A										
2P+E	0.168	84	84	72	72	77	126	34	M20	4.3
3P+E	0.232	84	84	72	72	84	134	34	M20	4.3
3P+N+E	0.256	84	84	72	72	91	141	34	M20	4.3
LV 32 A										
2P+E	0.325	110	110	98	98	96	168	39	M25	5.3
3P+N+E	0.364	110	110	98	98	102	168	39	M25	5.3

Interlocked switched sockets with small flange

Cat.Nos 0 573 00/01/02 and 0 573 20/21/22

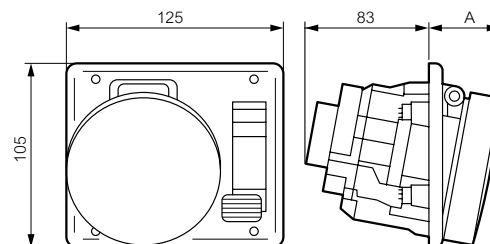

	16 A	IP	A	IP	A
2P+E	44	38	55	45	
3P+E	44	38	55	45	
3P+N+E	44	38	55	45	

PIN & SLEEVE DEVICES

P 17 Tempra Pro IP 44 - LV 16 and 32 A Mobile Products

Dimensions Straight plugs

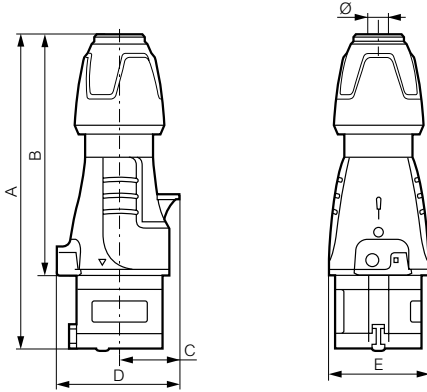

	A	B	C	D	E	Ø
LV 16 A						
2P+E	146 to 157	109.5 to 120.5	30	61	50	6.5 to 14
3P+E	146 to 157	109.5 to 120.5	34	67	55	7.10 to 15.5
3P+N+E	163 to 176	126.5 to 139.5	38	76	65	8 to 20
LV 32 A						
2P+E	172 to 185	127 to 140	40	78	65	8 to 20
3P+E	172 to 185	127 to 140	40	78	65	8 to 20
3P+N+E	179 to 189	133 to 143	45	86	71	11.9 to 22.2

Mobile sockets

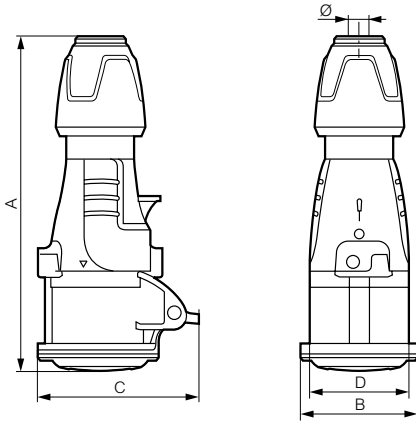

	A	B	C	D	Ø
LV 16 A					
2P+E	156 to 167	59	81	50	6.5 to 14
3P+E	157 to 168	65	88	55	7.10 to 15.5
3P+N+E	175 to 188	72	94	65	8 to 20
LV 32 A					
2P+E	184 to 197	73	99	65	8 to 20
3P+E	184 to 197	73.5	99	65	8 to 20
3P+N+E	190 to 203	79.5	105	71	11.9 to 22.2

PIN & SLEEVE DEVICES

P 17 Tempra Domestic Pin Configuration 16 A - 250 VA

Dimensions

Domestic pin configuration sockets

Cat.Nos 0 576 69/75

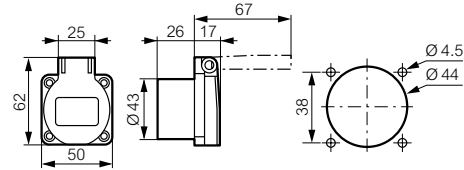

Cat.Nos 0 576 72/76

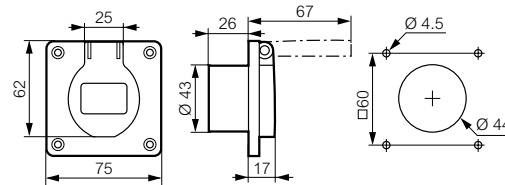

Adaptor 16 A - 230 V

Cat.No 0 521 05

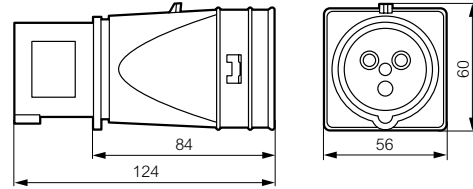

Flush mounting boxes

Cat.No 0 577 21

Cat.No 0 577 22

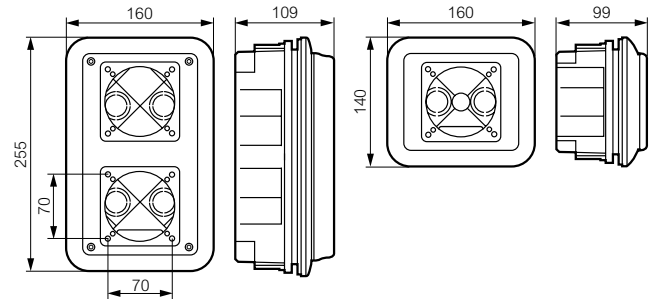

Panel mounting adaptor

Cat.No 0 539 48

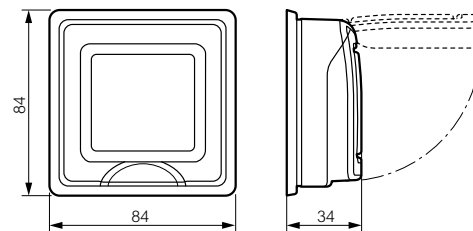

PIN & SLEEVE DEVICES

P 17 Tempra IP 44 - ELV 16 and 32 A

■ Characteristics

Terminal connection:

Max. 1 x 10 mm² (rigid for fixed products flexible for mobile products)

IP 44 according to IEC 60529 and EN 60529

IK 09 according to IEC 62262 and EN 62262

Material: plastic

Self-extinguishing: 850 °C (support of active parts) / 650 °C (plastic housing) Temp. rating: - 25 °C to + 40 °C

Conform to IEC 60309-1 / IEC 60309-2 and EN 60309-1 / EN 60309-2

■ Dimensions

Surface mounting sockets

Cat.Nos 0 552 06/56

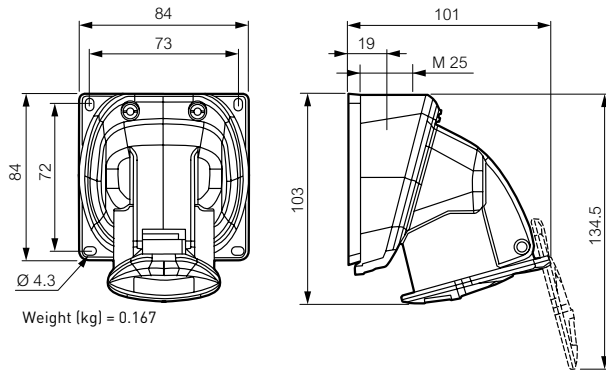

Panel mounting sockets

Cat.Nos 0 552 45/95

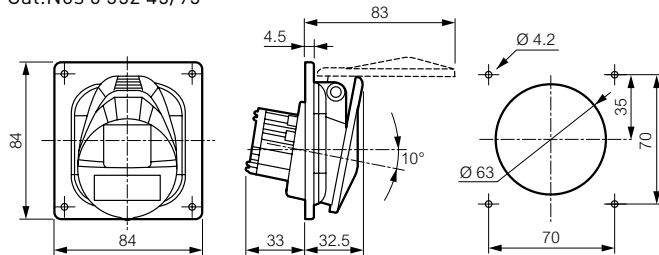

Appliance inlets

Cat.Nos 0 552 41/91

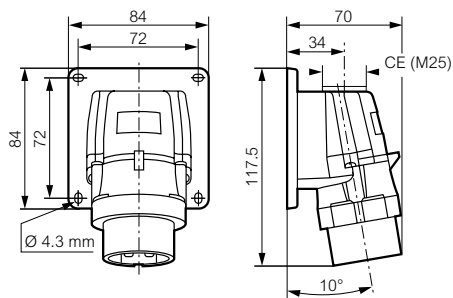

■ Dimensions ELV 16 and 32 A

Straight plugs

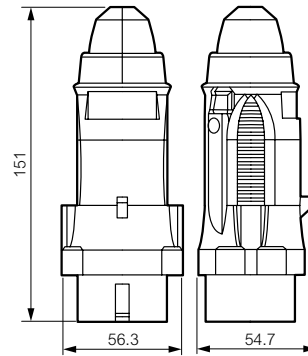

Weight (kg) = 0.132

Mobile sockets

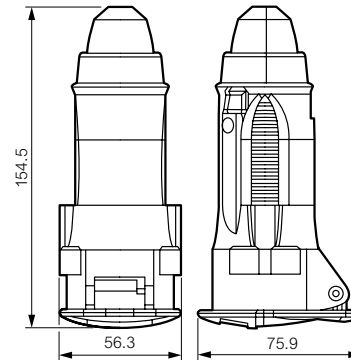

Weight (kg) = 0.16

PIN & SLEEVE DEVICES

P 17 Tempra Pro IP 66/67 - LV 16 and 32 A

Characteristics

Terminal connection:

- Panel and surface mounting sockets
16 A: max. 1 x 4 mm² rigid 32 A: max. 1 x 10 mm² rigid
- Plugs, mobile sockets:
16 A: max. 1 x 2,5 mm² flexible 32 A: max. 1 x 6 mm² flexible
- Appliance inlets:
16 A: max. 1 x 2.5 mm² rigid 32 A: max. 1 x 6 mm² rigid

IP 66/67 according to IEC 60529 and EN 60529

IK 09 according to IEC 62262 and EN 62262

Material: polyamide 6

Self-extinguishing: 850 °C (support of active parts) / 650 °C (plastic housing)

Temp. rating: - 25 °C to + 40 °C

Conform to IEC 60309-1 and IEC 60309-2

Dimensions

Surface mounting sockets

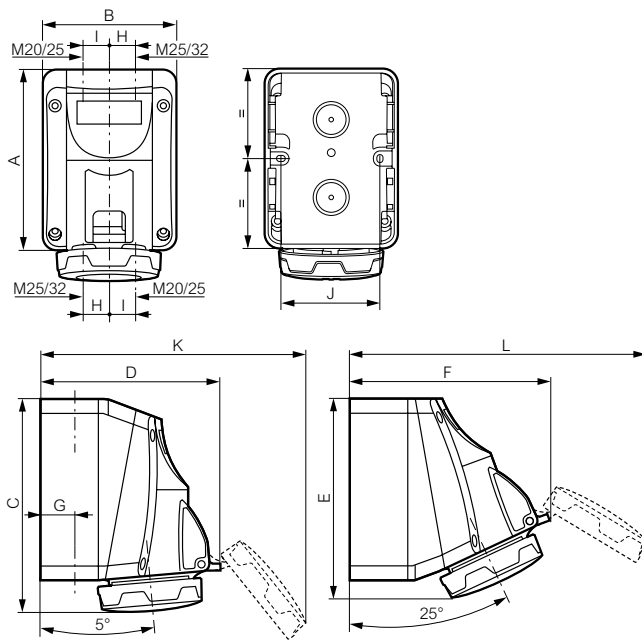

	A	B	C	D	E	F	G	H	I	J	K	L
LV 16 A												
2P+E	125	93	144	125	131	137	22	17	20	70	178	200
3P+E	125	93	144	133	131	145	22	17	20	70	194	215
3P+N+E	125	93	144	139	131	150	22	17	20	70	205	227
LV 32 A												
2P+E	150	113	171	155	156	170	28	22	26	90	224	250
3P+E	150	113	171	161	156	175	28	22	26	90	231	260

Panel mounting sockets

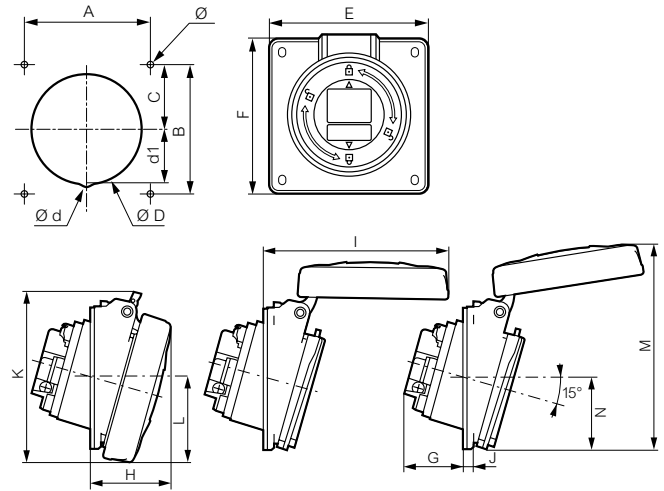

	Dimensions (mm)																
	A	B	C	ØD	Ød	d1	E	F	G	H	I	J	K	L	M	N	Ø
LV 16 A																	
2P+E	70	70	35	76.2	-	-	84	84	33.5	42	94	4.5	88	42.5	114	42	4.2
3P+E	70	70	35	76.2	-	-	84	84	35.5	43	101	4.5	94.5	46	118	42	4.2
3P+N+E	70	70	35	76.2	-	-	84	84	36.5	44	108.5	4.5	101	50	123	42.5	4.2
LV 32 A																	
2P+E/ 3P+E	70	70	35	76.2	-	-	84	94	41.5	50.5	118	4.5	105.5	54.5	129.5	47.5	4.2
3P+N+E	70	70	35	76.2	8	36	84	94	42.5	51.5	124.5	4.5	112	57.5	137	51	4.2

Appliance inlets

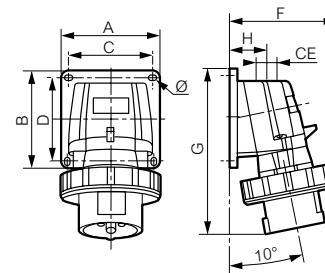

	Weight (kg)	A/B	C/D	F	G	H	CE	Ø
LV 16 A								
2P+E	0.188	84	72	87	126	34	M 20	4.3
3P+E	0.257	84	72	95	134	34	M 20	4.3
3P+N+E	0.297	84	72	100	141	34	M 20	4.3
LV 32 A								
2P+E	0.370	110	98	107	168	39	M 25	5.3
3P+E								
3P+N+E	0.413	110	98	113	168	39	M 25	5.3

PIN & SLEEVE DEVICES

P 17 Tempra Pro IP 66/67

LV 16 and 32 A - mobile products

■ Dimensions

Straight plugs

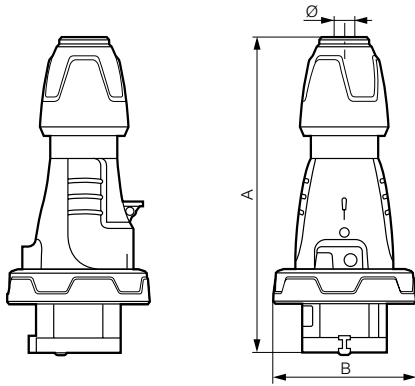

	A	B	Ø
LV 16 A			
2P+E	146 to 157	72.5	6.5 to 14
3P+E	146 to 157	80.5	7.10 to 15.5
3P+N+E	163 to 176	89	8 to 20
LV 32 A			
2P+E	172 to 185	93	8 to 20
3P+E	172 to 185	93	8 to 20
3P+N+E	179 to 189	100	11.9 to 22.2

Mobile sockets

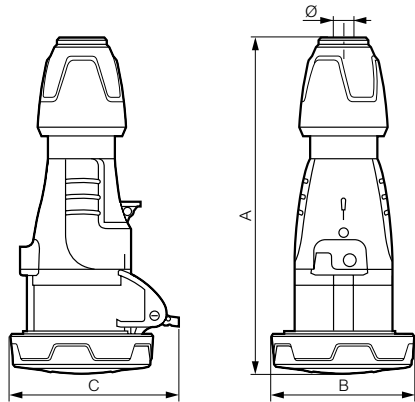

	A	B	C	Ø
LV 16 A				
2P+E	159 to 170	72.5	86	6.5 to 14
3P+E	159 to 170	80.5	93	7.1 to 15.5
3P+N+E	179 to 190	89	100	8 to 20
LV 32 A				
2P+E	187 to 200	93	104	8 to 20
3P+E	187 to 200	93	104	8 to 20
3P+N+E	192 to 205	100	110.5	11.9 to 22.2

PIN & SLEEVE DEVICES

P 17 Tempra Pro IP 66/67 - LV 63 A

■ Characteristics

Terminal connection:

- Panel and surface mounting sockets
63 A: max. 1 x 25 mm² rigid 125 A: max. 1 x 70 mm² rigid
- Appliance inlets:
63 A: max. 1 x 16 mm² rigid 125 A: max. 1 x 50 mm² rigid
- Plugs and mobile sockets:
63 A: max. 1 x 16 mm² flexible 125 A: max. 1 x 50 mm² flexible

IP 66/67 according to IEC 60529 and EN 60529

IK 09 according to IEC 62262 and EN 62262

Material: plastic

Self-extinguishing: 850 °C (support of active parts) / 650 °C (plastic housing)

Temp. rating: - 25 °C to + 40 °C. Conform to IEC 60309-1 and IEC 60309-2

■ Dimensions

Surface mounting sockets

Cat. Nos 0 587 40/44/45

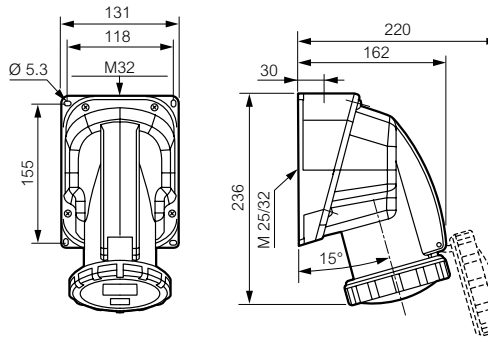

	Weight (kg)
3P+E	0.900
3P+N+E	0.950

Panel mounting sockets (inclined outlet)

Cat. Nos 0 587 20/24/25

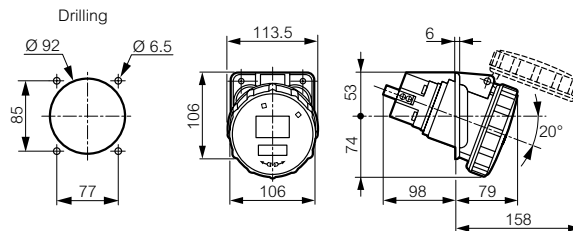

	Weight (kg)
3P+E	0.710
3P+N+E	0.770

Appliance inlets

Cat. Nos 0 587 30/34/35

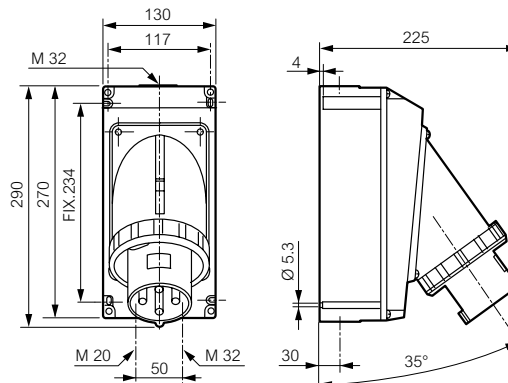

	Weight (kg)
3P+E	1.540
3P+N+E	1.610

PIN & SLEEVE DEVICES

P 17 Tempra Pro IP 66/67 - LV 125 A

■ Dimensions

Surface mounting sockets

Cat.Nos 0 591 06/07

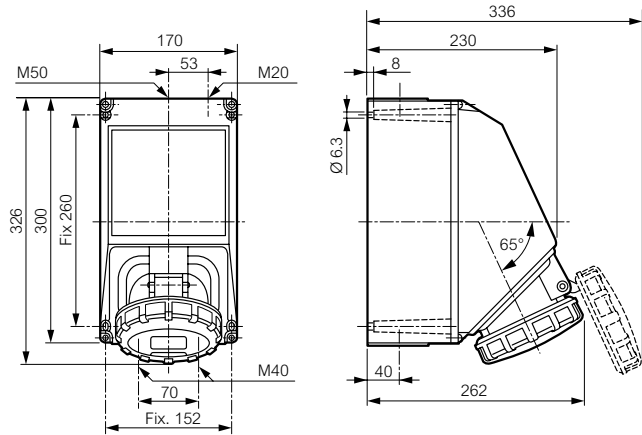

	Weight (kg)
3P+E	2.600
3P+N+E	2.730

Surface mounting sockets

Cat.Nos 0 591 16/17

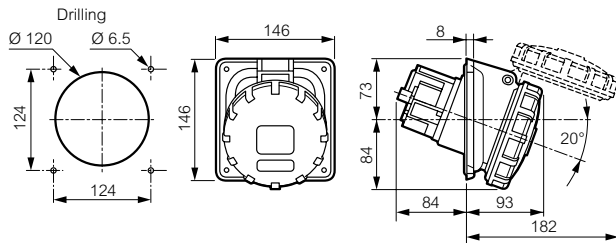

	Weight (kg)
3P+E	1.000
3P+N+E	1.200

Appliance inlets

Cat.Nos 0 591 46/47

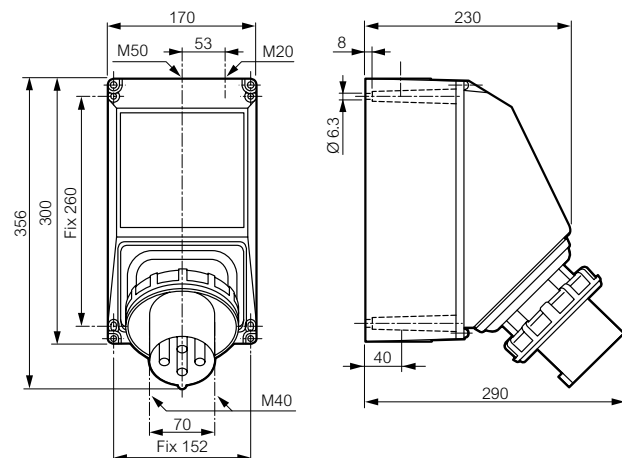

PIN & SLEEVE DEVICES

P 17 Tempra Pro IP 66/67 -

LV 63 and 125 A - mobile products

■ Dimensions LV 63 A

Straight plugs

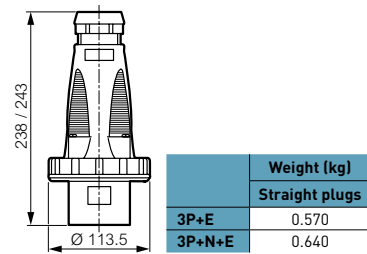

	Weight (kg)
Straight plugs	
3P+E	0.570
3P+N+E	0.640

Mobile sockets

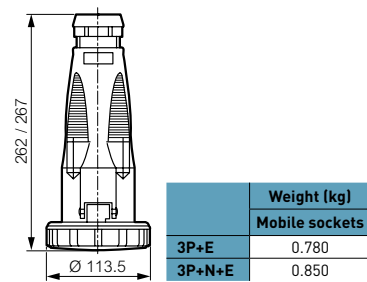

	Weight (kg)
Mobile sockets	
3P+E	0.780
3P+N+E	0.850

■ Dimensions LV 125 A

Straight plugs

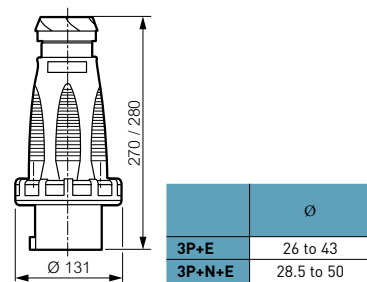

	Ø
3P+E	26 to 43
3P+N+E	28.5 to 50

Mobile sockets

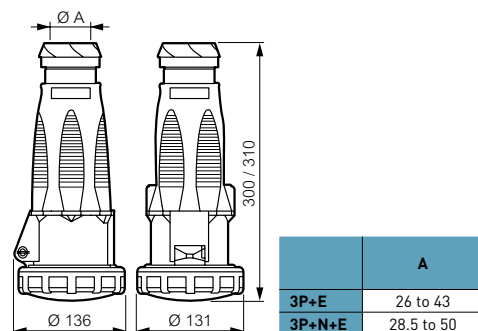

	A
3P+E	26 to 43
3P+N+E	28.5 to 50

FLEXCOR® WIRE MESH GRIPS



Rugged, easy-to-install and available in a wide range of sizes — our Flexcor® Wire Mesh Strain Relief, Cable-Pulling, and Cable-Support Grips are engineered to take some of the strain off of you.

Featured Products



DELUXE ALUMINUM
STRAIN RELIEF
CORD GRIPS

K-9



STRAIN RELIEF
LIQUID-TIGHT
GRIPS

K-16



LIQUID-TIGHT
CORD GRIPS

K-16

Product Description	K-2	Wire Mesh Support Grips	K-18
Split Support Grip Lace & Rod Mesh Termination	K-3	Support Grips Standard-Duty, Closed Mesh	K-19
Applications	K-4	Support Grips Standard-Duty, Split Lace	K-20
Wire Mesh Cord Grips	K-6	Support Grips Standard-Duty, Split Rod	K-21
Deluxe Aluminum Cord Grips	K-7	Support Grips Heavy-Duty	K-22
Deluxe Aluminum Strain Relief Cord Grips	K-9	Support Grips Service and Bus Drop	K-23
Nylon Cord Grips	K-10	Pulling Grips Junior- & Light-Duty	K-24
Nylon Strain Relief Cord Grips	K-11	Pulling Grips Medium-Duty	K-25
Nylon Mesh Cord Grips	K-12	Pulling Grips Heavy-Duty	K-26
Watertight Grips	K-13	Pulling Grips Multi-Weave	K-27
Deluxe Stainless Steel Cord Grips	K-14	Pulling Grips High Strength	K-28
Stainless Steel Strain Relief Cord Grips	K-15	Pulling Grips Slack	K-29
Strain Relief Liquid-Tight Grips	K-16	Selecting Properly Sized Pulling & Support Grips	K-30
Strain Relief Grips	K-17	Pulling & Support Grips Strength Information	K-32

FLEXCOR® WIRE MESH GRIPS

Product Description

Application

Flexcor® Wire Mesh Grips are used to support cable or conductor after it has been installed, pull electrical cable or conductor into place, provide strain relief at the point of wiring connections. Flexcor® devices protect cables, relieve stress, and prevent cable pull-out from fittings and terminations.

Support Grip Attachments

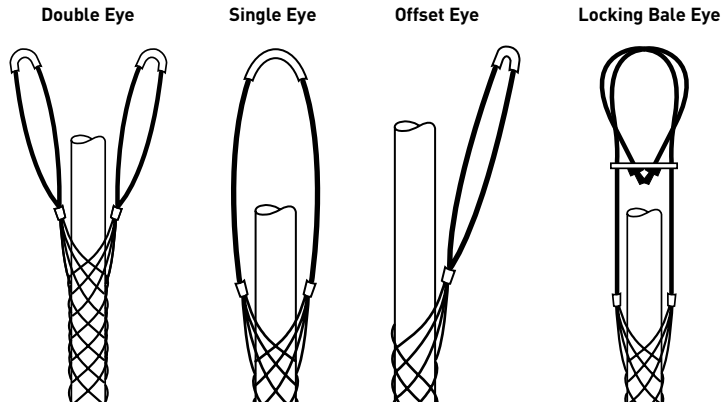

Available in four different attachments. Load is distributed over entire length of grip and will not injure cable.

Support Grip Mesh Types

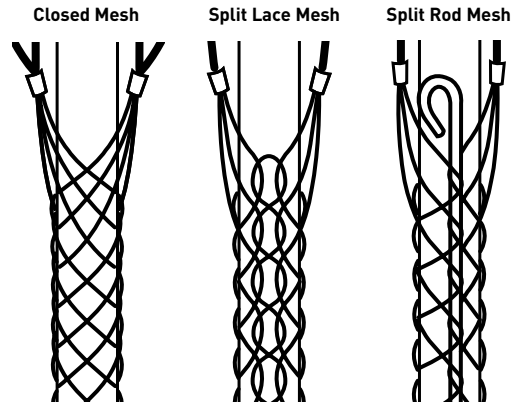

Available in three types and depends on availability of wire end.

Support Grips are designed to distribute weight of vertical or sloping runs in indoor or outdoor applications, providing direct tension and cable protection for electrical cable, metal rods, tubing or hose over the length of the grip.

Strain Relief Grip Fittings

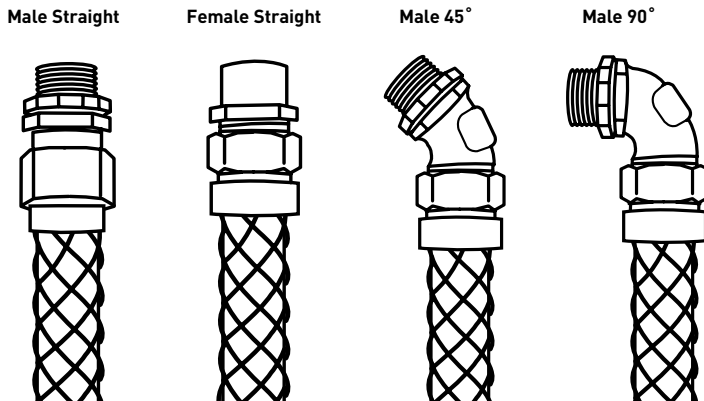

Prevents pull-out or damage to cable due to constant motion or flexing. Also for Liquid-Tight, hose and box connections.

Strain Relief Grips offered in single/double weave provide the extra grip support needed in tough industrial environments subjected to moisture in wiring of pendant stations, processing equipment, hand tools and extension cords.

Pulling Grips

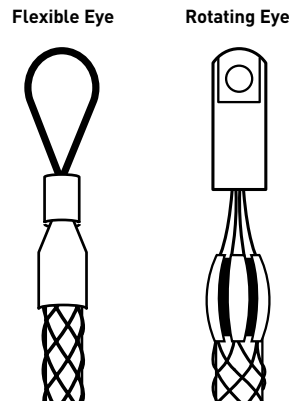

Assortment of rugged pulling grips available individually or in kits to make wire pulling easier.

Pulling Grips are ideal for overhead and underground pulling applications, such as industrial plant wiring, and rewiring and underground electrical pulls.

FLEXCOR® WIRE MESH GRIPS

Product Split Support Grip Lace & Rod Mesh Termination

Split Lace/Split Rod Attachments

(for use where end of cable is not accessible)

Split Lace Support Grip Mesh Termination

For Split Lace mesh termination, Flexcor® single weave Split Lace grips are provided with an additional single lace, two laces are provided with each double weave Split Lace grip. Lace strands should be same material as the grip.

1. Wrap split mesh grip around cable. Start lacing at top or bottom end of mesh. Thread lace through first two loops of split mesh and pull through until the lace is centered at this point. Lace as you would your shoe, crossing laces before lacing the next two loops.
2. Leave a space between adjoining loops approximately equal to the width of one diamond of the mesh.
3. Twist ends of lace strands together at end of grip or tie in a knot.
4. Wrap ends of lace tightly around grip. Excess lace may be cut off.

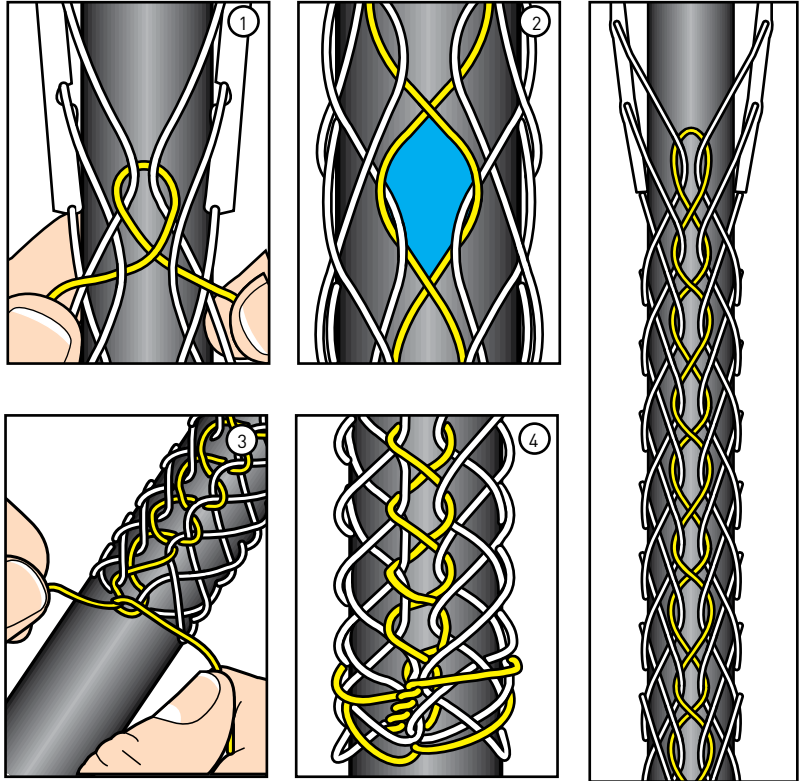

Split Rod Support Grip Mesh Termination

For Split Rod mesh termination, a weaving rod is supplied with each grip. The open mesh passes around the rod and matches up with the open mesh from the opposite direction. Split Rod support grips are quick and easy to use and reusable.

1. Wrap split mesh grip around cable. Thread rod through the open loops in a weaving motion, using end of the rod to engage loops.
2. A steady push and twist motion is required. Use other hand to bring mesh loops together so as to weave through them.
3. To remove, pull rod out.

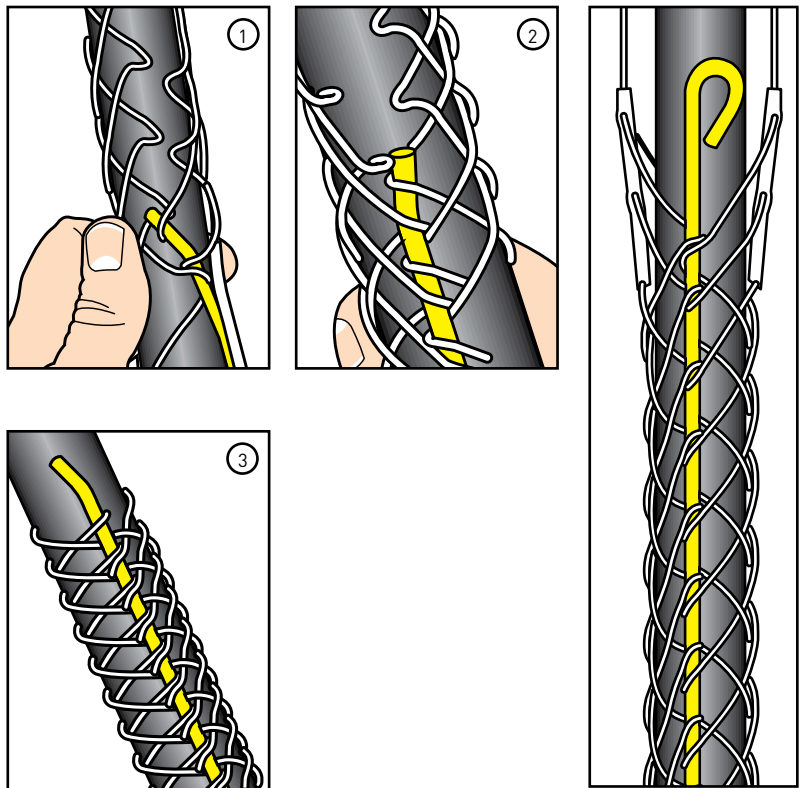

FLEXCOR® WIRE MESH GRIPS

Applications

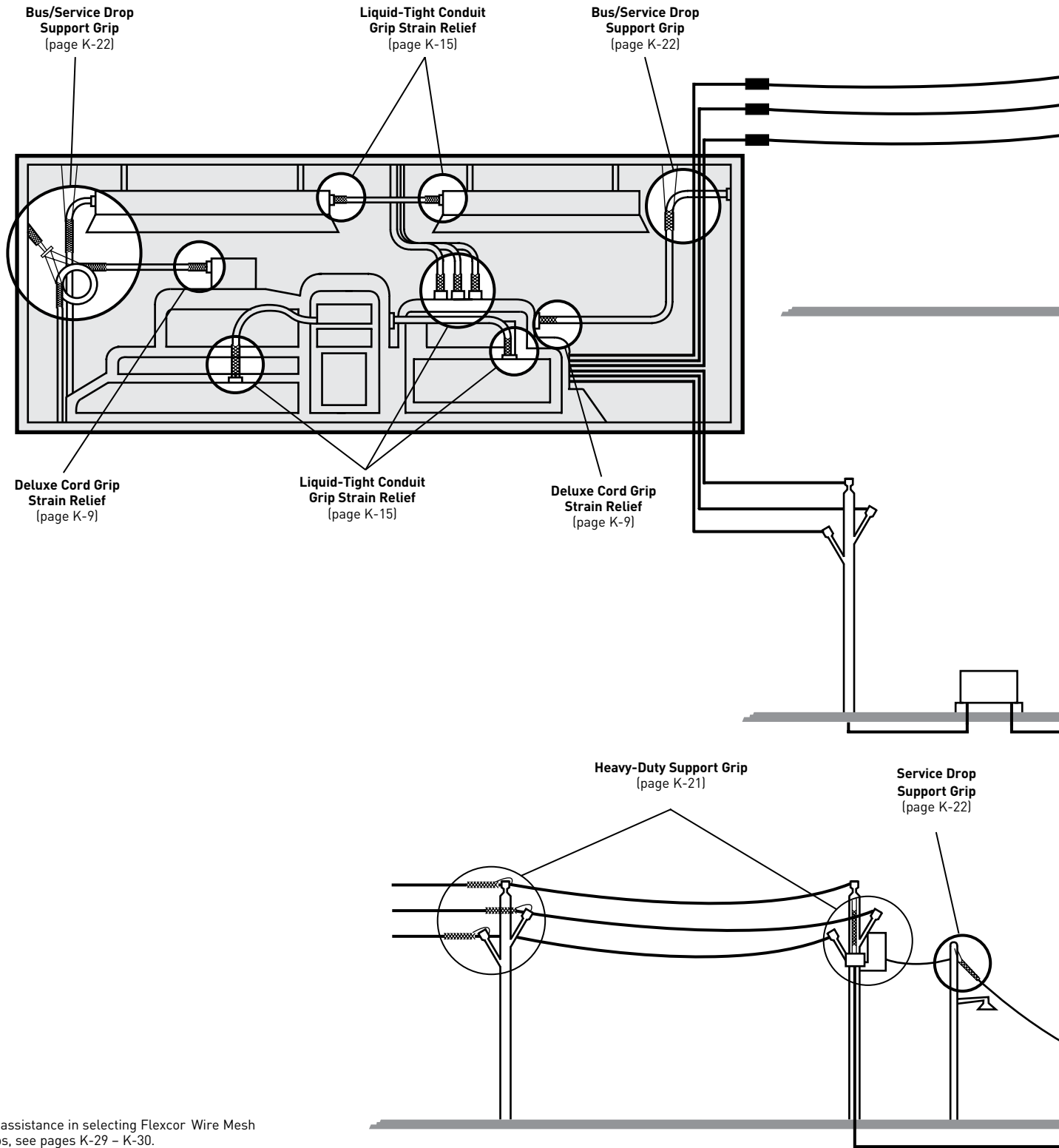

For assistance in selecting Flexcor Wire Mesh Grips, see pages K-29 – K-30.

FLEXCOR® WIRE MESH GRIPS

Applications

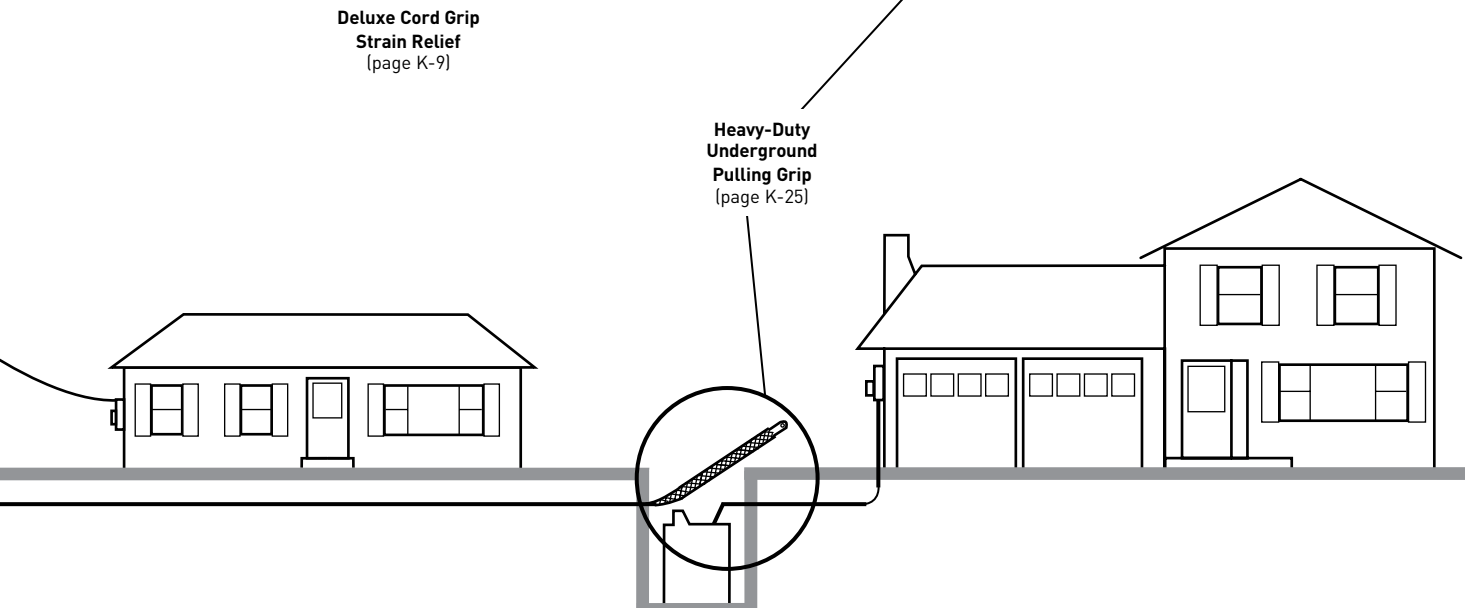
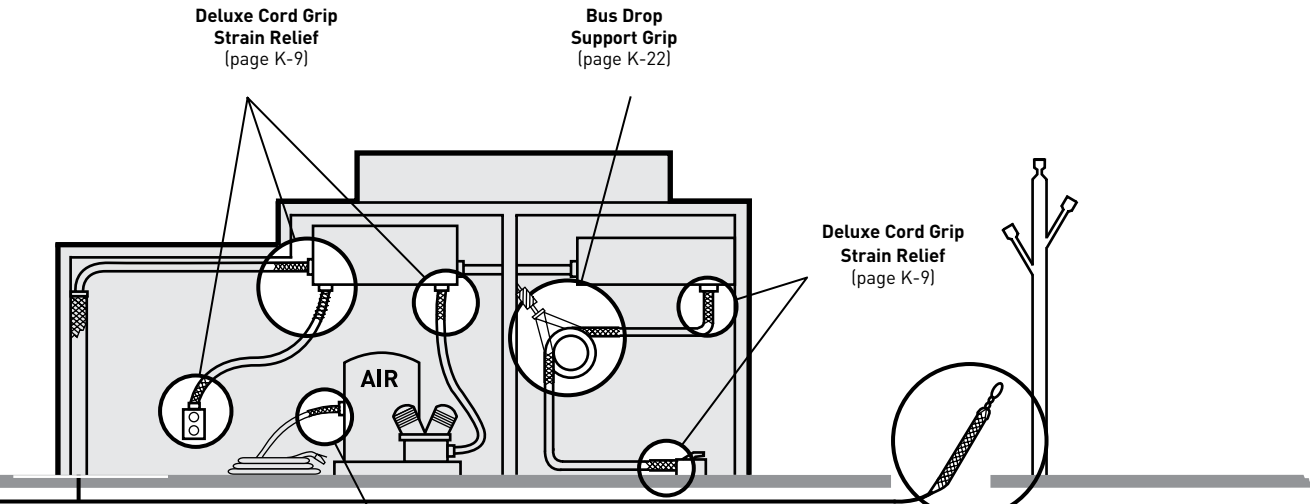
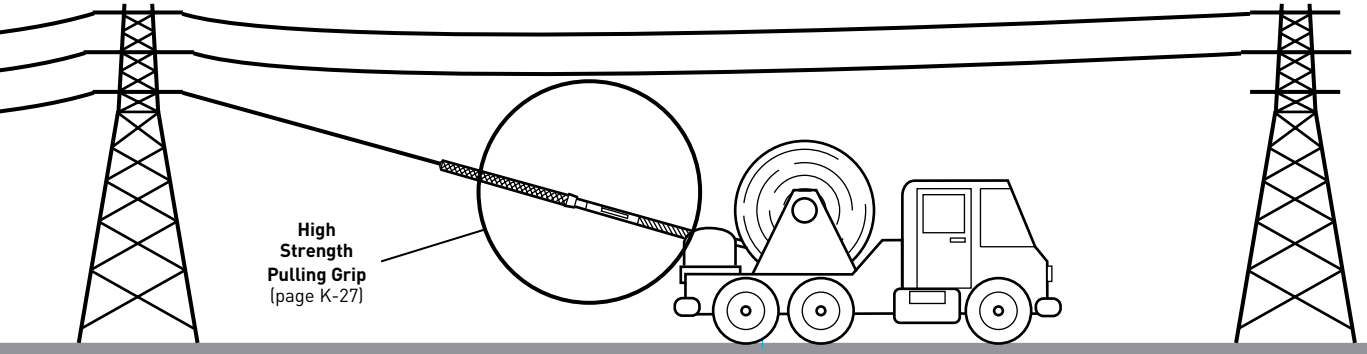

Most Flexcor products have UL and/or CSA Approvals. Please contact factory for approval information.

FLEXCOR® WIRE MESH CORD GRIPS

DELUXE CORD GRIPS

Key Features & Benefits:

- Deluxe cord grips are now available in aluminum, nylon and stainless steel. The mesh is woven of stainless steel for corrosion resistance.
- They are offered in single/double weave construction to help absorb direct pull, to resist flexing and binding, and to eliminate strain.
- They are recommended for indoor or outdoor use where subjected to moisture in the wiring of pendant stations, processing equipment, hand tools, and extension cord sets.
- Deluxe grips are suitable for use in hazardous locations per Class I, Div. 2; Class II, Div. 1 & 2; and Class III, Div. 1 & 2.



LIQUID-TIGHT CORD GRIPS

Key Features & Benefits:

- Liquid-Tight Grips are woven of stainless steel mesh with zinc-plated steel or malleable iron bodies and nuts for corrosion resistance.
- They are used to connect liquid-tight flexible conduit to electrical enclosures to prevent conduit pullout.
- Each fitting is supplied with an insulated throat to provide conductor insulation and protect against damage by flexing, heat expansion and contraction.
- Liquid-Tight Grips are recommended in the wiring of motors and any electrical enclosure where liquid-tight conduit is subject to motion or strain.

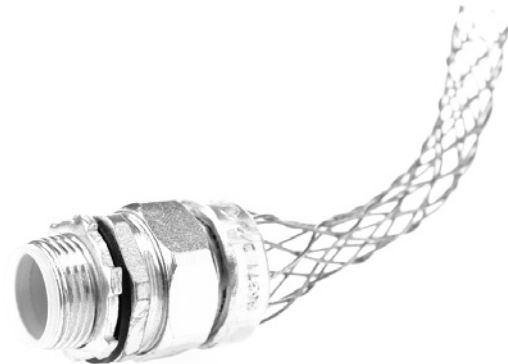

WIDE RANGE, DUST-TIGHT GRIPS

Key Features & Benefits:

- Wide Range Cord Grips are recommended for use in wiring of enclosures, power boxes, machine tools and power centers.
- Includes insulated bushing.



FLEXCOR® WIRE MESH GRIPS

Deluxe Aluminum Cord Grips

Description

Deluxe aluminum Cord Grips are UL Listed and CSA Certified for use in both indoor and outdoor applications to prevent cable pullout, to control arc of bend, and to provide a tight seal against environmental elements such as dirt, moisture and coolants. Cord Grips are available in a wide range of conduit sizes from 1/4" to 3" in straight, 90° and 45° styles. A unique design with a combination tightening surface that includes both a hex area and knurled surface provides extra gripping for initial hand tightening.



Aluminum Cord Grip 45°

Aluminum Cord Grip Straight

Aluminum Cord Grip 90°

STRAIGHT MALE CATALOG NUMBER	90° MALE CATALOG NUMBER	45° MALE CATALOG NUMBER	CABLE DIAMETER RANGE
1/4" ALUMINUM CORROSION-RESISTANT CORD GRIP			
CG25188	—	—	0.120" - 0.180"
CG25250	—	—	0.180" - 0.250"
CG25312	—	—	0.250" - 0.310"
CG25375	—	—	0.310" - 0.370"
CG25438	—	—	0.370" - 0.430"
3/8" ALUMINUM CORROSION-RESISTANT CORD GRIP			
CG38188	CG3890188	—	0.120" - 0.180"
CG38250	CG3890250	—	0.180" - 0.250"
CG38312	CG3890312	—	0.250" - 0.310"
CG38375	CG3890375	—	0.310" - 0.370"
CG38438	CG3890438	—	0.370" - 0.430"
1/2" ALUMINUM CORROSION-RESISTANT CORD GRIP			
CG501881	CG5090188	CG5045188	0.120" - 0.180" F1
CG501882	—	—	0.120" - 0.180" F2
CG502501	CG5090250	CG5045250	0.180" - 0.250" F1
CG502502	—	—	0.180" - 0.250" F2
CG503121	CG5090312	CG5045312	0.250" - 0.310" F1
CG503122	—	—	0.250" - 0.310" F2
CG503751	CG5090375	CG5045375	0.310" - 0.370" F1
CG503752	—	—	0.310" - 0.370" F2
CG504381	CG5090438	CG5045438	0.370" - 0.430" F1
CG504382	—	—	0.370" - 0.430" F2
—	CG5090500	CG5045500	0.430" - 0.500"
—	CG5090562	CG5045562	0.500" - 0.560"
—	CG5090625	CG5045625	0.560" - 0.620"
CG505002	—	—	0.430" - 0.500" F2
CG505003	—	—	0.430" - 0.500" F3
CG505622	—	—	0.500" - 0.560" F2
CG505623	—	—	0.500" - 0.560" F3
CG506252	—	—	0.560" - 0.620" F2
CG506253	—	—	0.560" - 0.620" F3
CG506883	—	—	0.620" - 0.680" F3
CG507503	—	—	0.620" - 0.750" F3
CG508123	—	—	0.680" - 0.810" F3

STRAIGHT MALE CATALOG NUMBER	90° MALE CATALOG NUMBER	45° MALE CATALOG NUMBER	CABLE DIAMETER RANGE
3/4" ALUMINUM CORROSION-RESISTANT CORD GRIP			
CG7510004	—	—	0.870" - 1.000" F4
CG751882	—	—	0.120" - 0.180" F2
CG752502	—	—	0.180" - 0.250" F2
CG753122	—	—	0.250" - 0.310" F2
CG753752	—	—	0.310" - 0.370" F2
CG754382	—	—	0.370" - 0.430" F2
CG755002	CG7590500	CG7545500	0.430" - 0.500" F2
CG755003	—	—	0.430" - 0.500" F3
CG755622	CG7590562	CG7545562	0.500" - 0.560" F2
CG755623	—	—	0.500" - 0.560" F3
CG755624	—	—	0.500" - 0.560" F4
CG756252	CG7590625	CG7545625	0.560" - 0.620" F2
CG756253	—	—	0.560" - 0.620" F3
CG756254	—	—	0.560" - 0.620" F4
CG756883	CG7590688	CG7545688	0.560" - 0.680" F3
CG756884	—	—	0.560" - 0.680" F4
CG757503	CG7590750	CG7545750	0.620" - 0.750" F3
CG757504	—	—	0.620" - 0.750" F4
CG758123	CG7590812	CG7545812	0.680" - 0.810" F3
CG758124	—	—	0.680" - 0.810" F4
CG758754	—	—	0.750" - 0.870" F4
CG759384	—	—	0.810" - 0.930" F4
1" ALUMINUM CORROSION-RESISTANT CORD GRIP			
CG10010004	CG100901000	CG100451000	0.870" - 1.000" F4
CG10010005	—	—	0.870" - 1.000" F5
CG10011255	—	—	1.000" - 1.120" F5
CG10012505	—	—	1.120" - 1.250" F5
CG10013755	—	—	1.250" - 1.370" F5
CG1005624	CG10090562	CG10045562	0.440" - 0.560" F4
CG1006254	CG10090625	CG10045625	0.560" - 0.620" F4
CG1006884	CG10090688	CG10045688	0.560" - 0.680" F4
CG1007504	CG10090750	CG10045750	0.620" - 0.750" F4
CG1008124	CG10090812	CG10045812	0.680" - 0.810" F4
CG1008754	CG10090875	CG10045875	0.750" - 0.870" F4
CG1005624	—	—	0.440" - 0.560" F4
CG1006254	—	—	0.560" - 0.620" F4
CG1006884	—	—	0.560" - 0.680" F4
CG1007504	—	—	0.620" - 0.750" F4
CG1008124	—	—	0.680" - 0.810" F4
CG1008754	—	—	0.750" - 0.870" F4
CG1009384	CG10090938	CG10045938	0.810" - 0.930" F4

Most Flexcor products have UL and/or CSA Approvals. Please contact factory for approval information.

All devices listed on this page meet NEMA 3R standards.

FLEXCOR® WIRE MESH GRIPS

Deluxe Aluminum Cord Grips

STRAIGHT MALE CATALOG NUMBER	90° MALE CATALOG NUMBER	45° MALE CATALOG NUMBER	CABLE DIAMETER RANGE
1 1/4" ALUMINUM CORROSION-RESISTANT CORD GRIP			
CG12510005	CG125901000	CG125451000	0.870" - 1.000" F5
CG12511255	—	—	1.000" - 1.120" F5
CG12512505	—	—	1.120" - 1.250" F5
CG12513755	—	—	1.250" - 1.370" F5
—	CG125901125	CG125451125	1.000" - 1.130" F5
—	CG125901250	CG125451250	1.130" - 1.250" F5
—	CG125901375	CG125451375	1.250" - 1.380" F5
CG1256885	CG12590688	CG12545688	0.560" - 0.680" F5
CG1258125	CG12590812	CG12545812	0.680" - 0.810" F5
CG1258755	CG12590875	CG12545875	0.750" - 0.870" F5
1 1/2" ALUMINUM CORROSION-RESISTANT CORD GRIP			
CG15010005	CG150901000	CG150451000	0.870" - 1.000" F5
CG15011255	CG150901125	CG150451125	1.000" - 1.120" F5
CG15012505	CG150901250	CG150451250	1.120" - 1.250" F5
CG15013755	CG150901375	CG150451375	1.250" - 1.370" F5
CG15013756	—	—	1.250" - 1.370" F6
CG15015626	CG150901562	—	1.430" - 1.560" F6
CG15016886	CG150901688	—	1.560" - 1.680" F6
CG15018126	CG150901812	—	1.680" - 1.810" F6
CG1506885	CG15090688	CG15045688	0.560" - 0.680" F5
CG1508125	CG15090812	CG15045812	0.680" - 0.810" F5
CG1508755	CG15090875	CG15045875	0.750" - 0.870" F5
2" ALUMINUM CORROSION-RESISTANT CORD GRIP			
CG20013756	CG2009013756	—	1.250" - 1.370" F6
CG20014376	—	—	1.310" - 1.430" F6
CG20015626	CG2009015626	—	1.430" - 1.560" F6
CG20016886	CG2009016886	—	1.560" - 1.680" F6
CG20018126	CG2009018126	—	1.680" - 1.810" F6
CG20018127	—	—	1.680" - 1.810" F7
CG20019387	—	—	1.810" - 1.940" F7
CG20020627	—	—	1.940" - 2.060" F7
CG20021887	—	—	2.060" - 2.190" F7
CG20023127	—	—	2.190" - 2.310" F7
CG20024387	—	—	2.310" - 2.440" F7
2 1/2" ALUMINUM CORROSION-RESISTANT CORD GRIP			
CG25018127	—	—	1.680" - 1.810" F7
CG25019387	—	—	1.810" - 1.940" F7
CG25020627	—	—	1.680" - 1.810" F7
CG25021887	—	—	1.680" - 1.810" F7
CG25023127	—	—	1.680" - 1.810" F7
CG25024387	—	—	1.680" - 1.810" F7



Aluminum Cord Grip 45°



Aluminum Cord Grip Straight



Aluminum Cord Grip 90°

STRAIGHT MALE CATALOG NUMBER	CABLE DIAMETER RANGE
3" ALUMINUM CORROSION-RESISTANT CORD GRIP	
CG30018127	1.680" - 1.810" F7
CG30019387	1.810" - 1.940" F7
CG30020627	1.940" - 2.060" F7
CG30021887	2.060" - 2.180" F7
CG30023127	2.180" - 2.310" F7
CG30024387	2.310" - 2.440" F7
CG30026259	2.440" - 2.630" F9
CG30028129	2.630" - 2.810" F9
CG30030009	2.810" - 3.000" F9
CG30032509	3.000" - 3.250" F9
3 1/2" ALUMINUM CORROSION-RESISTANT CORD GRIP	
CG35031808	3.000" - 3.180" F8
CG35033358	3.180" - 3.340" F8
CG35035308	3.340" - 3.530" F8
4" ALUMINUM CORROSION-RESISTANT CORD GRIP	
CG40036909	3.500" - 3.690" F9
CG40038559	3.690" - 3.860" F9
CG40040259	3.860" - 4.030" F9

FLEXCOR® WIRE MESH GRIPS

All devices listed on this page meet NEMA 3R standards.

FLEXCOR® WIRE MESH GRIPS

Strain Relief Deluxe Aluminum Cord Grips



Straight Male Connector

90° Male Connector

45° Male Connector

Straight Female Connector

Description

Deluxe cord grips are woven of stainless steel mesh with an aluminum body for corrosion resistance. They are offered in single/double weave construction to help absorb direct pull, to resist flexing and binding, and to eliminate strain. They are recommended for indoor or outdoor use where subjected to moisture in the wiring of pendant stations, processing equipment, hand tools, and extension cord sets.

NOTE: Stainless steel mesh is not suitable for marine use.

STRAIGHT MALE CATALOG NUMBER	90° MALE CATALOG NUMBER	45° MALE CATALOG NUMBER	STRAIGHT FEMALE CATALOG NUMBER	CABLE DIAMETER RANGE
1/2" NPT DELUXE CORD GRIPS				
CG406	CG40690	CG40645	—	0.250"-0.375"
CG408	CG40890	—	—	0.375"-0.500"
CG410	CG41090	CG41045	CG410F	0.500"-0.625"
CG411	—	—	—	0.625"-0.750"
CG412	—	—	—	0.750"-0.875"
3/4" NPT DELUXE CORD GRIPS				
CG606	—	—	—	0.250"-0.375"
CG608	CG60890	CG60845	—	0.375"-0.500"
CG610	CG61090	CG61045	—	0.500"-0.625"
CG612	CG61290	CG61245	—	0.625"-0.750"
1" NPT DELUXE CORD GRIPS				
CG809	—	—	—	0.375"-0.500"
CG811	—	—	—	0.500"-0.625"
CG812	CG81290	CG81245	CG812F	0.625"-0.750"
CG814	CG81490	CG81445	—	0.750"-0.875"
CG816	CG81690	CG81645	CG816F	0.875"-1.000"

STRAIGHT MALE CATALOG NUMBER	90° MALE CATALOG NUMBER	45° MALE CATALOG NUMBER	CABLE DIAMETER RANGE
1-1/4" NPT DELUXE CORD GRIPS			
CG1016	CG101690	—	0.875"-1.000"
CG1018	CG101890	—	1.000"-1.125"
CG1020	—	—	1.125"-1.250"
CG1022	—	CG102245	1.250"-1.375"
1-1/2" NPT DELUXE CORD GRIPS			
CG1218	—	—	1.000"-1.125"
CG1220	CG122090	—	1.125"-1.250"
CG1222	CG122290	CG122245	1.250"-1.375"
2" NPT DELUXE CORD GRIPS			
CG1422	CG142290	—	1.250"-1.375"
CG1424	CG142490	—	1.312"-1.437"
CG1426	CG142690	—	1.437"-1.562"
CG1428	CG142890	—	1.562"-1.687"
CG1430	CG143090	—	1.687"-1.812"
CG1432	CG143290	—	1.750"-1.875"
CG1434	—	—	1.812"-1.937"
CG1436	—	—	1.937"-2.062"
CG1438	—	—	2.062"-2.187"
CG1440	—	—	2.187"-2.312"
CG1442	—	—	2.312"-2.437"

STRAIGHT MALE CATALOG NUMBER	CABLE DIAMETER RANGE
2-1/2" NPT DELUXE CORD GRIPS	
CG1630	1.687"-1.812"
CG1634	1.812"-1.937"
CG1636	1.937"-2.062"
CG1638	2.062"-2.187"
CG1640	2.187"-2.312"
CG1642	2.312"-2.437"
3" NPT DELUXE CORD GRIPS	
CG1830	1.688"-1.812"
CG1834	1.812"-1.937"
CG1836	1.937"-2.062"
CG1838	2.062"-2.187"
CG1840	2.187"-2.312"
CG1842	2.312"-2.437"
CG1844	2.437"-2.625"
CG1846	2.625"-2.812"
CG1848	2.812"-3.000"
CG1850	3.000"-3.250"

FLEXCOR® WIRE MESH GRIPS

Nylon Cord Grips

Description

Non-Metallic Cord Connectors are constructed of a durable, nylon material which offers excellent corrosion resistance, is lightweight, durable and ideal for use in damp environments. Nylon Cord Connectors are ideally suited for use in applications with moisture or washdowns and they provide an environmental seal against dirt, coolants, as well as other chemicals.



Black Nylon Cord Grip Straight



Nylon Cord Grip Straight



Nylon Cord Grip 90°

STRAIGHT MALE CATALOG NO.	90° MALE CATALOG NO.	NPT SIZE	CABLE DIAMETER RANGE
CGN25075	—	1/4" NPT	0.075 - 0.135
CGN25135	—		0.135 - 0.200
CGN25200	—		0.200 - 0.265
CGN38125	CGN3890125	3/8" NPT	0.125 - 0.187
CGN38187	CGN3890187		0.187 - 0.250
CGN38250	CGN3890250		0.250 - 0.312
CGN38312	CGN3890312		0.312 - 0.375
CGN38375	CGN3890375		0.375 - 0.437
CGN50062	CGN5090062		1/2" NPT
CGN50125	CGN5090125	0.125 - 0.187	
CGN50187	CGN5090187	0.187 - 0.250	
CGN50250	CGN5090250	0.250 - 0.312	
CGN50312	CGN5090312	0.312 - 0.375	
CGN50375	CGN5090375	0.375 - 0.437	
CGN50437	CGN5090437	0.437 - 0.500	
CGN50500	CGN5090500	0.500 - 0.562	
CGN50562	CGN5090562	0.562 - 0.625	
CGN50250BK	—	BLACK 1/2" NPT	
CGN50312BK	—		0.312 - 0.375
CGN50375BK	—		0.375 - 0.437
CGN50437BK	—		0.437 - 0.500
CGN50500BK	—		0.500 - 0.562
CGN75187	CGN7590187	3/4" NPT	0.187 - 0.250
CGN75250	CGN7590250		0.250 - 0.375
CGN75375	CGN7590375		0.375 - 0.437
CGN75437	CGN7590437		0.437 - 0.562
CGN75500	CGN7590500		0.500 - 0.625
CGN75562	CGN7590562		0.562 - 0.687
CGN75625	CGN7590625		0.625 - 0.750
CGN75687	CGN7590687		0.687 - 0.812
CGN75187BK	—		BLACK 3/4" NPT
CGN75250BK	—	0.250 - 0.375	
CGN75375BK	—	0.375 - 0.437	
CGN75437BK	—	0.437 - 0.562	
CGN75500BK	—	0.500 - 0.625	
CGN75562BK	—	0.562 - 0.687	
CGN75625BK	—	0.625 - 0.750	
CGN75687BK	—	0.687 - 0.812	

STRAIGHT MALE CATALOG NO.	90° MALE CATALOG NO.	NPT SIZE	CABLE DIAMETER RANGE
CGN100437	CGN10090437	1" NPT	0.437 - 0.562
CGN100500	CGN10090500		0.500 - 0.625
CGN100562	CGN10090562		0.562 - 0.687
CGN100625	CGN10090625		0.625 - 0.750
CGN100687	CGN10090687		0.687 - 0.812
CGN100750	CGN10090750		0.750 - 0.875
CGN100812	CGN10090812		0.812 - 0.937
CGN100875	CGN10090875		0.875 - 1.000
CGN1001000	CGN100901000		1.000 - 1.125
CGN100625BK	—		BLACK 1" NPT
CGN100687BK	—	0.687 - 0.812	
CGN100750BK	—	0.750 - 0.875	
CGN100812BK	—	0.812 - 0.937	
CGN100875BK	—	0.875 - 1.000	
CGN125750	CGN12590750	1 1/4" NPT	0.750 - 0.875
CGN125875	CGN12590875		0.875 - 1.000
CGN1251000	CGN125901000		1.000 - 1.125
CGN1251125	CGN125901125		1.125 - 1.250
CGN1251250	CGN125901250	1.250 - 1.355	
CGN5042UF	—	1/2" NPT OVAL UF CABLE	0.218 - 0.421
CGN5064UF	—	1/2" NPT OVAL UF CABLE	0.218 - 0.640
—	CGN509042UF	90D 1/2" NPT OVAL UF CABLE	0.218 - 0.421
—	CGN509064UF	90D 1/2" NPT OVAL UF CABLE	0.218 - 0.640
CGN7542UF	—	3/4" NPT OVAL UF CABLE	0.218 - 0.421
CGN7564UF	—	3/4" NPT OVAL UF CABLE	0.218 - 0.640
—	CGN759042UF	90D 3/4" NPT OVAL UF CABLE	0.218 - 0.421
—	CGN759064UF	90D 3/4" NPT OVAL UF CABLE	0.218 - 0.640

All devices on this page meet NEMA 3R standards, except for Black, which meet NEMA 6P standards.

Most Flexcor products have UL and/or CSA Approvals. Please contact factory for approval information.

FLEXCOR® WIRE MESH GRIPS

Nylon Strain Relief Cord Grips

Description

Nylon strain relief cord grips are woven of stainless steel mesh with a nylon body for corrosion resistance. They are offered in single/double weave construction to help absorb direct pull, to resist flexing and binding, and to eliminate strain. They are recommended for indoor or outdoor use where subjected to moisture in the wiring of pendant stations, processing equipment, hand tools, and extension cord sets.

NOTE: Stainless steel mesh is not suitable for marine use.

STRAIGHT MALE CATALOG NUMBER	90° MALE CATALOG NUMBER	CABLE DIAMETER RANGE
1/2" NPT NYLON STRAIN RELIEFCORD GRIPS WITH MESH		
CGN50187M	CGN5090187M	0.187 - 0.250
CGN50250M	CGN5090250M	0.250 - 0.312
CGN50312M	CGN5090312M	0.312 - 0.375
CGN50375M	CGN5090375M	0.375 - 0.437
CGN50437M	CGN5090437M	0.437 - 0.500
CGN50500M	CGN5090500M	0.500 - 0.562
CGN50562M	CGN5090562M	0.562 - 0.625



Nylon Cord Grip Straight Male with Stainless Steel Mesh

STRAIGHT MALE CATALOG NUMBER	90° MALE CATALOG NUMBER	CABLE DIAMETER RANGE
3/4" NPT NYLON STRAIN RELIEF CORD GRIPS WITH MESH		
CGN75187M	—	0.187 - 0.250
CGN75250M	CGN7590250M	0.250 - 0.375
CGN75375M	CGN7590375M	0.375 - 0.437
CGN75437M	CGN7590437M	0.437 - 0.562
CGN75500M	CGN7590500M	0.500 - 0.625
CGN75562M	CGN7590562M	0.562 - 0.687
CGN75625M	CGN7590625M	0.625 - 0.750
CGN75687M	CGN7590687M	0.687 - 0.812



90° Nylon Cord Grip with Stainless Steel Mesh

STRAIGHT MALE CATALOG NUMBER	90° MALE CATALOG NUMBER	CABLE DIAMETER RANGE
1" NPT NYLON STRAIN RELIEF CORD GRIPS WITH MESH		
CGN100437M	—	0.437 - 0.562
CGN100500M	—	0.500 - 0.625
CGN100562M	CGN10090562M	0.562 - 0.687
CGN100625M	CGN10090625M	0.625 - 0.750
CGN100687M	CGN10090687M	0.687 - 0.812
CGN100750M	CGN10090750M	0.750 - 0.875
CGN100812M	—	0.812 - 0.937
CGN100875M	CGN10090875M	0.875 - 1.000

All devices on this page meet NEMA 3R standards.

Most Flexcor products have UL and/or CSA Approvals. Please contact factory for approval information.

FLEXCOR® WIRE MESH GRIPS

Nylon Mesh Cord Grips

Description

Nylon mesh cord grips are woven of nylon mesh with a nylon body for corrosion resistance. They are offered in single/double weave construction to help absorb direct pull, to resist flexing and binding, and to eliminate strain. They are recommended for indoor or outdoor use where subjected to moisture in the wiring of pendant stations, processing equipment, hand tools, and extension cord sets.

STRAIGHT MALE CATALOG NUMBER	90° MALE CATALOG NUMBER	CABLE DIAMETER RANGE
1/2" NPT NYLON MESH CORD GRIPS		
CGN50187NM	CGN5090187NM	0.187 - 0.250
CGN50250NM	CGN5090250NM	0.250 - 0.312
CGN50312NM	CGN5090312NM	0.312 - 0.375
CGN50375NM	CGN5090375NM	0.375 - 0.437
CGN50437NM	CGN5090437NM	0.437 - 0.500

STRAIGHT MALE CATALOG NUMBER	90° MALE CATALOG NUMBER	CABLE DIAMETER RANGE
3/4" NPT NYLON MESH CORD GRIPS		
CGN75187NM	—	0.187 - 0.250
CGN75250NM	CGN7590250NM	0.250 - 0.375
CGN75375NM	CGN7590375NM	0.375 - 0.437
CGN75437NM	CGN7590437NM	0.437 - 0.562
CGN75500NM	CGN7590500NM	0.500 - 0.625
CGN75562NM	CGN7590562NM	0.562 - 0.687
CGN75625NM	CGN7590625NM	0.625 - 0.750

STRAIGHT MALE CATALOG NUMBER	90° MALE CATALOG NUMBER	CABLE DIAMETER RANGE
1" NPT NYLON MESH CORD GRIPS		
CGN100437NM	CGN10090437NM	0.437 - 0.562
CGN100500NM	CGN10090500NM	0.500 - 0.625
CGN100562NM	—	0.562 - 0.687
CGN100625NM	CGN10090625NM	0.625 - 0.750
CGN100687NM	CGN10090687NM	0.687 - 0.812
CGN100750NM	CGN10090750NM	0.750 - 0.875
CGN100812NM	—	0.812 - 0.937
CGN100875NM	CGN10090875M	0.875 - 1.000



Straight Nylon Cord Grips with Nylon Mesh



90° Nylon Cord Grips with Nylon Mesh

FLEXCOR® WIRE MESH GRIPS

Watertight Grips

Description

Watertight cord grips are woven of stainless steel or nylon with a plastic body for corrosion resistance. They are offered in single/double weave construction to help absorb direct pull, to resist flexing and binding, and to eliminate strain. They are recommended for indoor or outdoor use where subjected to moisture in the wiring of pendant stations, processing equipment, hand tools, and extension cord sets.

NOTE: Stainless steel mesh is not suitable for marine use.

CATALOG NUMBER	DESCRIPTION	NPT SIZE	CABLE DIAMETER RANGE
WT50312NM	Watertight Grip with Nylon Mesh	1/2"	0.312 - 0.375
WT50375NM		1/2"	0.375 - 0.437
WT50437NM		1/2"	0.437 - 0.500
WT75437NM		3/4"	0.437 - 0.562
WT75500NM		3/4"	0.500 - 0.625
WT75562NM		3/4"	0.562 - 0.687
WT75625NM		3/4"	0.625 - 0.750
WT100562NM		1"	0.562 - 0.687
WT100625NM		1"	0.625 - 0.750
WT100750NM		1"	0.750 - 0.875
WT100875NM	1"	0.875 - 1.000	
WT50312M	Watertight Grip with Stainless Steel Mesh	1/2"	0.312 - 0.375
WT50375M		1/2"	0.375 - 0.437
WT50437M		1/2"	0.437 - 0.500
WT50500M		1/2"	0.500 - 0.562
WT50562M		1/2"	0.562 - 0.625
WT75375M		3/4"	0.375 - 0.437
WT75437M		3/4"	0.437 - 0.562
WT75500M		3/4"	0.500 - 0.625
WT75562M		3/4"	0.562 - 0.687
WT75625M		3/4"	0.625 - 0.750
WT75687M		3/4"	0.687 - 0.812
WT100562M		1"	0.562 - 0.687
WT100625M		1"	0.625 - 0.750
WT100750M		1"	0.750 - 0.875
WT100812M		1"	0.812 - 0.370
WT100875M		1"	0.875 - 1.000



Watertight Strain Relief Cord Grip with Stainless Steel Mesh



Watertight Strain Relief Cord Grip with Nylon Mesh



Watertight Strain Relief Cord Grip with Nylon Mesh

FLEXCOR® WIRE MESH GRIPS

Deluxe Stainless Steel Cord Grips

CATALOG NUMBER CORD GRIP	CABLE DIAMETER RANGE
3/8" STAINLESS STEEL 304 IP 67 68 CORD GRIP	
CGSS38188	0.120" - 0.180"
CGSS38250	0.180" - 0.250"
CGSS38312	0.250" - 0.310"
CGSS38375	0.310" - 0.370"
CGSS38438	0.370" - 0.430"
1/2" STAINLESS STEEL 304 IP 67 68 CORD GRIP	
CGSS50188	0.120" - 0.180"
CGSS50250	0.180" - 0.250"
CGSS50312	0.250" - 0.310"
CGSS50375	0.310" - 0.370"
CGSS50438	0.370" - 0.430"
CGSS50500	0.430" - 0.500"
CGSS50562	0.500" - 0.560"
CGSS50625	0.560" - 0.620"
3/4" STAINLESS STEEL 304 IP 67 68 CORD GRIP	
CGSS75500	0.430" - 0.500"
CGSS75562	0.500" - 0.560"
CGSS75625	0.560" - 0.620"
CGSS75688	0.560" - 0.680"
CGSS75750	0.620" - 0.750"
CGSS75812	0.680" - 0.810"
1" STAINLESS STEEL 304 IP 67 68 CORD GRIP	
CGSS1001000	0.870" - 1.000"
CGSS100562	0.440" - 0.560"
CGSS100625	0.560" - 0.620"
CGSS100688	0.560" - 0.680"
CGSS100750	0.620" - 0.750"
CGSS100812	0.680" - 0.810"
CGSS100875	0.750" - 0.870"
CGSS100938	0.810" - 0.930"
1 1/4" STAINLESS STEEL 304 IP 67 68 CORD GRIP	
CGSS1251000	0.870" - 1.000"
CGSS1251125	1.000" - 1.120"
CGSS1251250	1.120" - 1.250"
CGSS1251375	1.250" - 1.370"
CGSS125688	0.560" - 0.680"
CGSS125812	0.680" - 0.810"
CGSS125875	0.750" - 0.870"

Description

The Pass & Seymour series of corrosion-resistant cord connectors feature a body and compression nut made of Type 304 stainless steel with exceptional tensile strength and the highest levels of durability in severely corrosive environments. All stainless steel cord grips include an embedded Buna-N O-Ring. These connectors are recommended for use in washdowns or high moisture environments in food processing plants, petrochemical facilities, wastewater treatment plants, pulp & paper mills and chemical manufacturing factories. (Note: Type 316 stainless steel also available upon request and minimums may apply.)

NOTE: Stainless steel mesh is not suitable for marine use.

CATALOG NUMBER CORD GRIP	CABLE DIAMETER RANGE
1 1/2" STAINLESS STEEL 304 IP 67 68 CORD GRIP	
CGSS1501000	0.870" - 1.000"
CGSS1501125	1.000" - 1.120"
CGSS1501250	1.120" - 1.250"
CGSS1501375	1.250" - 1.370"
CGSS150688	0.560" - 0.680"
CGSS150812	0.680" - 0.810"
CGSS150875	0.750" - 0.870"
2" STAINLESS STEEL 304 IP 67 68 CORD GRIP	
CGSS2001375	1.250" - 1.370"
CGSS2001562	1.430" - 1.560"
CGSS2001688	1.560" - 1.680"
CGSS2001812	1.680" - 1.810"
CGSS2001938	1.810" - 1.940"
CGSS2002062	1.940" - 2.060"
CGSS2002188	2.060" - 2.190"
CGSS2002312	2.190" - 2.310"
CGSS2002438	2.310" - 2.440"
2 1/2" STAINLESS STEEL 304 IP 67 68 CORD GRIP	
CGSS2501812	1.680" - 1.810"
CGSS2501938	1.810" - 1.940"
CGSS2502062	1.940" - 2.060"
CGSS2502188	2.060" - 2.190"
CGSS2502312	2.190" - 2.310"
CGSS2502438	2.310" - 2.440"
3" STAINLESS STEEL 304 IP 67 68 CORD GRIP	
CGSS3002635	2.440" - 2.630"
CGSS3002812	2.630" - 2.810"
CGSS3003000	2.810" - 3.000"
CGSS3003250	3.000" - 3.250"



Stainless Steel Deluxe Cord Grip

FLEXCOR® WIRE MESH GRIPS

Stainless Steel Strain Relief Cord Grips



Stainless Steel Cord grip with Stainless Steel Mesh

CATALOG NUMBER CG MESH	CABLE DIAMETER RANGE
3/8" STAINLESS STEEL 304 IP 67 68 CORD GRIP	
—	0.120" - 0.180"
CGSS38250M	0.180" - 0.250"
CGSS38312M	0.250" - 0.310"
CGSS38375M	0.310" - 0.370"
CGSS38438M	0.370" - 0.430"
1/2" STAINLESS STEEL 304 IP 67 68 CORD GRIP	
—	0.120" - 0.180"
CGSS50250M	0.180" - 0.250"
CGSS50312M	0.250" - 0.310"
CGSS50375M	0.310" - 0.370"
CGSS50438M	0.370" - 0.430"
CGSS50500M	0.430" - 0.500"
CGSS50562M	0.500" - 0.560"
CGSS50625M	0.560" - 0.620"
3/4" STAINLESS STEEL 304 IP 67 68 CORD GRIP	
CGSS75500M	0.430" - 0.500"
CGSS75562M	0.500" - 0.560"
CGSS75625M	0.560" - 0.620"
CGSS75687M	0.560" - 0.680"
CGSS75750M	0.620" - 0.750"
CGSS75812M	0.680" - 0.810"
1" STAINLESS STEEL 304 IP 67 68 CORD GRIP	
CGSS1001000M	0.870" - 1.000"
CGSS100562M	0.440" - 0.560"
CGSS100625M	0.560" - 0.620"
CGSS100687M	0.560" - 0.680"
CGSS100750M	0.620" - 0.750"
CGSS100812M	0.680" - 0.810"
CGSS100875M	0.750" - 0.870"
CGSS100937M	0.810" - 0.930"
1 1/4" STAINLESS STEEL 304 IP 67 68 CORD GRIP	
CGSS1251000M	0.870" - 1.000"
CGSS1251125M	1.000" - 1.120"
CGSS1251250M	1.120" - 1.250"
CGSS1251375M	1.250" - 1.370"
CGSS125688M	0.560" - 0.680"
CGSS125812M	0.680" - 0.810"
CGSS125875M	0.750" - 0.870"

Description

Stainless Steel strain relief cord grips are woven of stainless steel mesh with a Type 304 stainless steel body for corrosion resistance. They are offered in single/double weave construction to help absorb direct pull, to resist flexing and binding, and to eliminate strain. They are recommended for indoor or outdoor use where subjected to moisture and corrosion in the wiring of pendant stations, processing equipment, hand tools and power cord sets.

NOTE: Stainless steel mesh is not suitable for marine use.

CATALOG NUMBER CG MESH	CABLE DIAMETER RANGE
1 1/2" STAINLESS STEEL 304 IP 67 68 CORD GRIP	
CGSS1501000M	0.870" - 1.000"
CGSS1501125M	1.000" - 1.120"
CGSS1501250M	1.120" - 1.250"
CGSS1501375M	1.250" - 1.370"
CGSS150688M	0.560" - 0.680"
CGSS150812M	0.680" - 0.810"
CGSS150875M	0.750" - 0.870"
2" STAINLESS STEEL 304 IP 67 68 CORD GRIP	
CGSS2001375M	1.250" - 1.370"
CGSS2001562M	1.430" - 1.560"
CGSS2001688M	1.560" - 1.680"
CGSS2001812M	1.680" - 1.810"
CGSS2001938M	1.810" - 1.940"
CGSS2002062M	1.940" - 2.060"
CGSS2002188M	2.060" - 2.190"
CGSS2002312M	2.190" - 2.310"
CGSS2002438M	2.310" - 2.440"
2 1/2" STAINLESS STEEL 304 IP 67 68 CORD GRIP	
CGSS2501812M	1.680" - 1.810"
CGSS2501938M	1.810" - 1.940"
CGSS2502062M	1.940" - 2.060"
CGSS2502188M	2.060" - 2.190"
CGSS2502312M	2.190" - 2.310"
CGSS2502438M	2.310" - 2.440"
3" STAINLESS STEEL 304 IP 67 68 CORD GRIP	
CGSS3002635M	2.440" - 2.630"
CGSS3002812M	2.630" - 2.810"
CGSS3003000M	2.810" - 3.000"
CGSS3003250M	3.000" - 3.250"

FLEXCOR® WIRE MESH GRIPS

Strain Relief Liquid-Tight Grips



Straight Male Connector

 Non-Metallic
Straight Male Connector

90° Male Connector

45° Male Connector

Description

Rated IP68 and NEMA 4X, Stainless Steel Liquid-Tight Connectors offer corrosion resistance for the toughest environment. For use in wet or dry locations to seal electrical connections against dust, dirt, oil, water, chemicals and other corrosive elements. These are available in straight and 90 degree, 3/8" to 2" NPT. The stainless steel liquid-tight includes a nylon insulated throat and Viton® O-Ring.

NOTE: Stainless steel mesh is not suitable for marine use.

STRAIGHT MALE CATALOG NUMBER	90° MALE CATALOG NUMBER	45° MALE CATALOG NUMBER	NPT SIZE	MESH LENGTH
LIQUID-TIGHT FOR METALLIC FLEXIBLE CONDUIT				
STB38SF	—	STB4538SF	3/8"	2.625"
STB50SF	STB9050SF	STB4550SF	1/2"	3.875"
STB75SF	STB9075SF	STB4575SF	3/4"	4.375"
STB100SF	STB90100SF	STB45100SF	1"	5.25"
STB125SF	STB90125SF	STB45125SF	1-1/4"	5.625"
STB150SF	STB90150SF	—	1-1/2"	5.75"
STB200SF	STB90200SF	STB45200SF	2"	7.5"
STB250SF	—	STB45250SF	2-1/2"	9.625"
STB300SF	STB90300SF	STB45300SF	3"	10.625"

STRAIGHT MALE CATALOG NUMBER	NPT SIZE	MESH LENGTH
LIQUID-TIGHT GRIPS FOR NON-METALLIC TYPE "A" FLEXIBLE CONDUIT		
STBN38SF	3/8"	9"
STBN50SF	1/2"	10"
STBN75SF	3/4"	10.5"
STBN100SF	1"	12"
STBN125SF	1-1/4"	17"
STBN150SF	1-1/2"	21.5"
STBN200SF	2"	24"

STRAIGHT MALE CATALOG NUMBER	90° MALE CATALOG NUMBER	NPT SIZE
STAINLESS STEEL LIQUIDTIGHT FITTINGS		
LTB38SS	LTB3890SS	3/8"
LTB50SS	LTB5090SS	1/2"
LTB75SS	LTB7590SS	3/4"
LTB100SS	LTB10090SS	1"
LTB125SS	LTB12590SS	1 1/4"
LTB150SS	LTB15090SS	1 1/2"
LTB200SS	LTB20090SS	2"

FLEXCOR® WIRE MESH GRIPS

Strain Relief Grips



Wide Range, Straight Male, Dust Tight

Description

Wide range grips are recommended for use in wiring of enclosures, power boxes, machine tools, and power centers. Includes insulated bushing.

CATALOG NUMBER	NPT SIZE	CABLE DIAMETER RANGE
WIDE RANGE, STRAIGHT MALE, DUST TIGHT GRIPS		
BOX22	1/2"	0.220"-0.320"
BOX30	1/2"	0.300"-0.430"
BOX40	1/2"	0.400"-0.540"
BOX52	3/4"	0.520"-0.730"
BOX70	1"	0.700"-1.000"
BOX94	1-1/4"	0.940"-1.250"
BOX120	1-1/2"	1.200"-1.500"
BOX140	2"	1.400"-1.750"

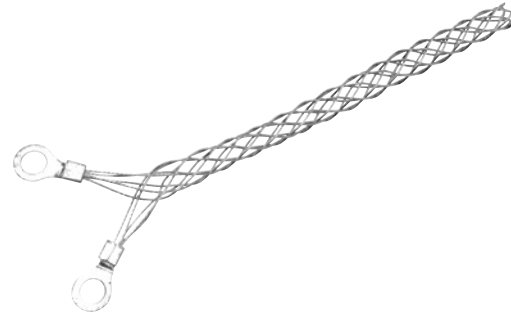

Turnlok/EHU Strain Relief Grips

Description

Wire mesh grips for Turnlok and EHU straight blade plugs and connectors provide additional strain-relief for wiring device plugs and connectors used on portable equipment in commercial and institutional applications, and industrial plant and construction site areas, which incur abnormally high abuse.

CATALOG NUMBER	CABLE DIAMETER RANGE	MESH LENGTH
TURNLOK®/EHU STRAIN RELIEF GRIPS		
FC22GL	0.220"-0.320"	4.00"
FC30GL	0.300"-0.430"	5.00"
FC40GL	0.400"-0.560"	5.00"
FC52GL	0.520"-0.730"	9.00"
FC70GL	0.700"-0.940"	7.50"
FC94GL	0.940"-1.250"	11.50"

FLEXCOR® WIRE MESH SUPPORT GRIPS

SUPPORT GRIPS

Key Features & Benefits:

- Available in Single Eye, Double Eye, Offset Eye and Universal Eye grips.
- Stainless steel mesh available.
- Used to support electrical and fiber optic cable, metal rods and tubing.
- Woven of corrosion-resistant tinned bronze wire.

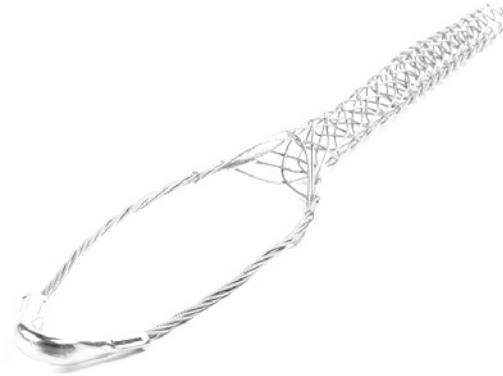

SERVICE & BUS DROP

Key Features & Benefits:

- Service Drops provide support for utility distribution lines from service pole to building or from pole to pole.
- Woven from tinned bronze for superior corrosion resistance.
- Bus Drops relieve direct tension from critical connection and absorb vibration and flexing.
- Woven of galvanized steel wire.



PULLING GRIPS

Key Features & Benefits:

- Connect insulated wired bundles to pulling tape or to pull wire or rope through conduit.
- Ideal for overhead and underground pulling applications.
- Double weave or galvanized steel for greater strength.
- Flexible and Rotating Eye available.



FLEXCOR® WIRE MESH GRIPS

Support Grips Standard-Duty, Closed Mesh

Description

Standard closed mesh support grips are designed for loads up to 600 lbs. and vertical runs of no more than 100 ft. They are available in a variety of eye styles and cable ranges for supporting electrical and fiber optic cable, metal rods, and tubing. Closed mesh support grips are used when the end of the cable is accessible. Support grips are woven of corrosion-resistant tinned-bronze or stainless steel wire.

CATALOG NUMBER TINNED-BRONZE	CATALOG NUMBER STAINLESS STEEL	CABLE DIAMETER RANGE	BALE LENGTH	MESH LENGTH	APPROXIMATE BREAK STRENGTH*
STANDARD-DUTY, CLOSED MESH, SINGLE EYE GRIPS					
FC050U	FC050USS	0.500"-0.610"	7"	11"	770 lbs.
FC062U	FC062USS	0.620"-0.740"	8"	11"	960 lbs.
FC075U	FC075USS	0.750"-0.990"	8"	14"	1,300 lbs.
FC100U	FC100USS	1.000"-1.240"	9"	15"	1,680 lbs.
FC125U	FC125USS	1.250"-1.490"	10"	16"	1,680 lbs.
FC150U	FC150USS	1.500"-1.740"	12"	18"	1,680 lbs.
FC175U	FC175USS	1.750"-1.990"	14"	20"	2,640 lbs.
FC200U	FC200USS	2.000"-2.490"	16"	22"	3,760 lbs.
FC250U	FC250USS	2.500"-2.990"	18"	24"	3,760 lbs.
FC300U	FC300USS	3.000"-3.490"	21"	26"	5,040 lbs.
STANDARD-DUTY, CLOSED MESH, DOUBLE EYE GRIPS					
FC050UU	FC050UUSS	0.500"-0.610"	4"	11"	770 lbs.
FC062UU	FC062UUSS	0.620"-0.740"	4"	11"	1,150 lbs.
FC075UU	FC075UUSS	0.750"-0.990"	4"	14"	1,320 lbs.
FC100UU	FC100UUSS	1.000"-1.240"	5"	15"	1,920 lbs.
FC125UU	FC125UUSS	1.250"-1.490"	5"	16"	1,920 lbs.
FC150UU	FC150UUSS	1.500"-1.740"	6"	18"	1,920 lbs.
FC175UU	FC175UUSS	1.750"-1.990"	6"	20"	3,150 lbs.
FC200UU	FC200UUSS	2.000"-2.490"	6"	22"	3,360 lbs.
FC250UU	FC250UUSS	2.500"-2.990"	6"	24"	3,360 lbs.
STANDARD-DUTY, CLOSED MESH, OFFSET EYE GRIPS					
FC0500F	FC0500FSS	0.500"-0.610"	4"	11"	770 lbs.
FC0620F	FC0620FSS	0.620"-0.740"	4"	11"	960 lbs.
FC0750F	FC0750FSS	0.750"-0.990"	4"	14"	960 lbs.
FC1000F	FC1000FSS	1.000"-1.240"	5"	15"	1,680 lbs.
FC1250F	FC1250FSS	1.250"-1.490"	5"	16"	1,680 lbs.
FC1500F	FC1500FSS	1.500"-1.740"	5"	18"	1,680 lbs.
FC1750F	FC1750FSS	1.750"-1.990"	6"	20"	2,640 lbs.
FC2000F	FC2000FSS	2.000"-2.490"	6"	22"	3,760 lbs.
FC2500F	FC2500FSS	2.500"-2.990"	8"	24"	3,760 lbs.
FC3000F	FC3000FSS	3.000"-3.490"	9"	26"	5,040 lbs.
FC3500F	FC3500FSS	3.500"-3.990"	9"	28"	5,040 lbs.
STANDARD-DUTY, CLOSED MESH, LOCKING BALE GRIPS (UNIVERSAL EYE)					
FC050LB	FC050LBSS	0.500"-0.610"	18"	11"	770 lbs.
FC062LB	FC062LBSS	0.620"-0.740"	18"	11"	1,150 lbs.
FC075LB	FC075LBSS	0.750"-0.990"	18"	14"	1,320 lbs.
FC100LB	FC100LBSS	1.000"-1.240"	18"	15"	1,920 lbs.
FC125LB	FC125LBSS	1.250"-1.490"	18"	16"	1,920 lbs.
FC150LB	FC150LBSS	1.500"-1.740"	18"	18"	1,920 lbs.
FC175LB	FC175LBSS	1.750"-1.990"	18"	20"	3,150 lbs.
FC200LB	FC200LBSS	2.000"-2.490"	18"	22"	3,360 lbs.
FC250LB	FC250LBSS	2.500"-2.990"	18"	24"	3,360 lbs.
FC300LB	FC300LBSS	3.000"-3.490"	18"	26"	5,280 lbs.
FC350LB	FC350LBSS	3.500"-3.990"	18"	28"	5,280 lbs.



Single Eye Grips

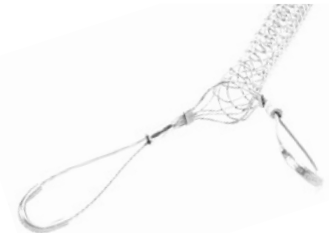

Double Eye Grips



Offset Eye Grips



Locking Bale Grips
(Universal Eye)

*To determine workload safety factor, divide approximate break strength by 10.
See Page K-31 for strength information.

Most Flexcor products have UL and/or CSA Approvals.
Please contact factory for approval information.

FLEXCOR® WIRE MESH GRIPS

Support Grips Standard-Duty, Split Lace

Description

Split lace support grips are designed for loads up to 600 lbs. and vertical runs of no more than 100 ft. They are available in a variety of eye styles and cable ranges for supporting electrical and fiber optic cable, metal rods, and tubing. Split lace support grips are used when the end of the cable cannot easily be accessed and the support grip is intended for permanent installation. Support grips are woven of corrosion-resistant tinned-bronze or stainless steel wire.

CATALOG NUMBER TINNED-BRONZE	CATALOG NUMBER STAINLESS STEEL	CABLE DIAMETER RANGE	BALE LENGTH	MESH LENGTH	APPROXIMATE BREAK STRENGTH*
STANDARD-DUTY, SPLIT LACE, SINGLE EYE					
FS050U	FS050USS	0.500"-0.610"	7"	11"	770 lbs.
FS062U	FS062USS	0.620"-0.740"	8"	11"	960 lbs.
FS075U	FS075USS	0.750"-0.990"	8"	14"	1,320 lbs.
FS100U	FS100USS	1.000"-1.240"	9"	15"	1,680 lbs.
FS125U	FS125USS	1.250"-1.490"	10"	16"	1,680 lbs.
FS150U	FS150USS	1.500"-1.740"	12"	18"	1,680 lbs.
FS175U	FS175USS	1.750"-1.990"	14"	20"	2,640 lbs.
FS200U	FS200USS	2.000"-2.490"	16"	22"	3,760 lbs.
FS250U	FS250USS	2.500"-2.990"	18"	24"	3,760 lbs.
FS300U	FS300USS	3.000"-3.490"	21"	26"	5,040 lbs.
FS350U	FS350USS	3.500"-3.990"	24"	28"	5,040 lbs.
STANDARD-DUTY, SPLIT LACE, DOUBLE EYE					
FS050UU	FS050UUSS	0.500"-0.610"	4"	11"	770 lbs.
FS062UU	FS062UUSS	0.620"-0.740"	4"	11"	1,150 lbs.
FS100UU	FS100UUSS	1.000"-1.240"	5"	15"	1,920 lbs.
FS125UU	FS125UUSS	1.250"-1.490"	5"	16"	1,920 lbs.
FS150UU	FS150UUSS	1.500"-1.740"	5"	18"	1,920 lbs.
FS175UU	FS175UUSS	1.750"-1.990"	6"	20"	3,150 lbs.
FS200UU	FS200UUSS	2.000"-2.490"	6"	22"	3,360 lbs.
FS250UU	FS250UUSS	2.500"-2.990"	6"	24"	3,360 lbs.
FS300UU	FS300UUSS	3.000"-3.490"	8"	26"	5,280 lbs.
FS350UU	FS350UUSS	3.500"-3.990"	8"	28"	5,280 lbs.
STANDARD-DUTY, SPLIT LACE, OFFSET EYE					
FS0500F	FS0500FSS	0.500"-0.610"	4"	11"	770 lbs.
FS0620F	FS0620FSS	0.620"-0.740"	4"	11"	960 lbs.
FS0750F	FS0750FSS	0.750"-0.990"	4"	14"	960 lbs.
FS1000F	FS1000FSS	1.000"-1.240"	5"	15"	1,680 lbs.
FS1250F	FS1250FSS	1.250"-1.490"	5"	16"	1,680 lbs.
FS1500F	FS1500FSS	1.500"-1.740"	5"	18"	1,680 lbs.
FS1750F	FS1750FSS	1.750"-1.990"	8"	20"	2,640 lbs.
FS2000F	FS2000FSS	2.000"-2.490"	8"	22"	3,760 lbs.
FS2500F	FS2500FSS	2.500"-2.990"	8"	24"	3,760 lbs.
FS3000F	FS3000FSS	3.000"-3.490"	9"	26"	5,040 lbs.
FS3500F	FS3500FSS	3.500"-3.990"	9"	28"	5,040 lbs.
STANDARD-DUTY, SPLIT LACE, LOCKING BALE (UNIVERSAL EYE)					
FS050LB	FS050LBSS	0.500"-0.610"	18"	11"	770 lbs.
FS062LB	FS062LBSS	0.620"-0.740"	18"	11"	1,150 lbs.
FS100LB	FS100LBSS	1.000"-1.240"	18"	15"	1,920 lbs.
FS125LB	FS125LBSS	1.250"-1.490"	18"	16"	1,920 lbs.
FS150LB	FS150LBSS	1.500"-1.740"	18"	18"	1,920 lbs.
FS175LB	FS175LBSS	1.750"-1.990"	18"	20"	3,150 lbs.
FS200LB	FS200LBSS	2.000"-2.490"	18"	22"	3,360 lbs.
FS250LB	FS250LBSS	2.500"-2.990"	18"	24"	3,360 lbs.
FS300LB	FS300LBSS	3.000"-3.490"	18"	26"	5,280 lbs.
FS350LB	FS350LBSS	3.500"-3.990"	18"	28"	5,280 lbs.



Split Lace, Single Eye

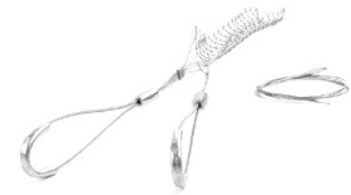

Split Lace, Double Eye



Split Lace, Offset Eye



Split Lace, Locking Bale (Universal Eye)

*To determine workload safety factor, divide approximate break strength by 10. See Page K-31 for strength information.

Most Flexcor products have UL and/or CSA Approvals. Please contact factory for approval information.

FLEXCOR® WIRE MESH GRIPS

Support Grips Standard-Duty, Split Rod

Description

Split rod support grips are designed for loads up to 600 lbs. and vertical runs of no more than 100 ft. They are available in a variety of eye styles and cable ranges for supporting electrical and fiber optic cable, metal rods, and tubing. Split rod support grips are used when the end of the cable cannot be easily accessed and the installation is temporary. Support grips are woven of corrosion-resistant tinned-bronze or stainless steel wire.

CATALOG NUMBER TINNED-BRONZE	CATALOG NUMBER STAINLESS STEEL	CABLE DIAMETER RANGE	BALE LENGTH	MESH LENGTH	APPROXIMATE BREAK STRENGTH*
STANDARD-DUTY, SPLIT ROD, SINGLE EYE					
FR050U	FR050USS	0.500"-0.610"	7"	11"	770 lbs.
FR062U	FR062USS	0.620"-0.740"	8"	11"	960 lbs.
FR075U	FR075USS	0.750"-0.990"	8"	14"	1,320 lbs.
FR100U	FR100USS	1.000"-1.240"	9"	15"	1,680 lbs.
FR125U	FR125USS	1.250"-1.490"	10"	16"	1,680 lbs.
FR150U	FR150USS	1.500"-1.740"	12"	18"	1,680 lbs.
FR175U	FR175USS	1.750"-1.990"	14"	20"	2,640 lbs.
FR200U	FR200USS	2.000"-2.490"	16"	22"	3,760 lbs.
STANDARD-DUTY, SPLIT ROD, DOUBLE EYE					
FR050UU	FR050UUSS	0.500"-0.610"	4"	11"	770 lbs.
FR062UU	FR062UUSS	0.620"-0.740"	4"	11"	960 lbs.
FR075UU	FR075UUSS	0.750"-0.990"	4"	14"	960 lbs.
FR100UU	FR100UUSS	1.000"-1.240"	5"	15"	1,680 lbs.
FR125UU	FR125UUSS	1.250"-1.490"	5"	16"	1,680 lbs.
FR150UU	FR150UUSS	1.500"-1.740"	5"	18"	1,680 lbs.
FR175UU	FR175UUSS	1.750"-1.990"	6"	20"	2,640 lbs.
FR200UU	FR200UUSS	2.000"-2.490"	6"	22"	3,760 lbs.
STANDARD-DUTY, SPLIT ROD, OFFSET EYE					
FR0500F	FR0500FSS	0.500"-0.610"	4"	11"	770 lbs.
FR0620F	FR0620FSS	0.620"-0.740"	4"	11"	960 lbs.
FR0750F	FR0750FSS	0.750"-0.990"	4"	14"	960 lbs.
FR1000F	FR1000FSS	1.000"-1.240"	5"	15"	1,680 lbs.
FR1250F	FR1250FSS	1.250"-1.490"	5"	16"	1,680 lbs.
FR1500F	FR1500FSS	1.500"-1.740"	5"	18"	1,680 lbs.
FR1750F	FR1750FSS	1.750"-1.990"	6"	20"	2,640 lbs.
FR2000F	FR2000FSS	2.000"-2.490"	6"	22"	3,760 lbs.
STANDARD-DUTY, SPLIT ROD, LOCKING BALE (UNIVERSAL EYE)					
FR050LB	FR050LBSS	0.500"-0.610"	10"	9"	770 lbs.
FR062LB	FR062LBSS	0.620"-0.740"	10"	9"	1,150 lbs.
FR075LB	FR075LBSS	0.750"-0.990"	10"	11"	1,320 lbs.
FR100LB	FR100LBSS	1.000"-1.240"	14"	13"	1,920 lbs.
FR125LB	FR125LBSS	1.250"-1.490"	14"	15"	1,920 lbs.
FR150LB	FR150LBSS	1.500"-1.740"	14"	16"	1,920 lbs.
FR175LB	FR175LBSS	1.750"-1.990"	14"	17"	3,150 lbs.
FR200LB	FR200LBSS	2.000"-2.490"	18"	20"	3,360 lbs..

*To determine workload safety factor, divide approximate break strength by 10.
See Page K-31 for strength information.



Split Rod, Single Eye

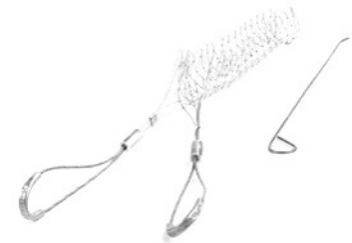

Split Rod, Double Eye

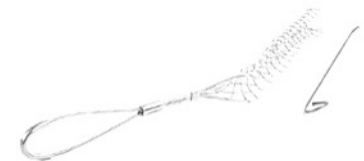

Split Rod, Offset Eye



Split Rod, Locking Bale
(Universal Eye)

FLEXCOR® WIRE MESH GRIPS

Support Grips Heavy-Duty

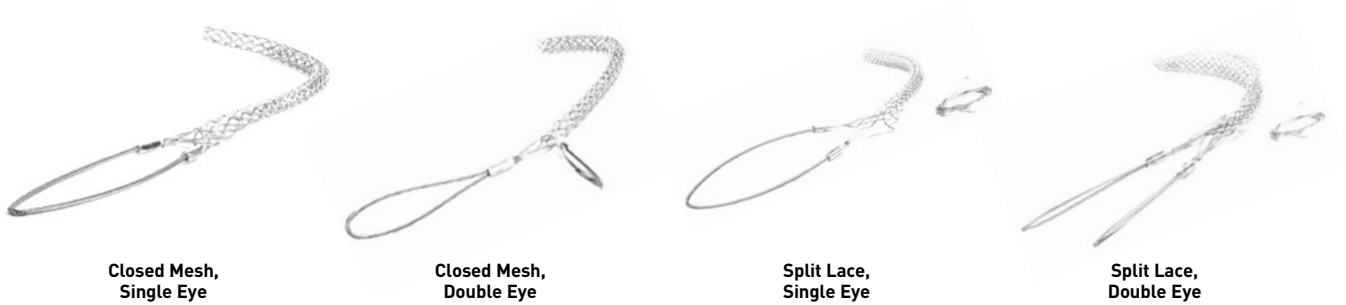

Closed Mesh,
Single Eye

Closed Mesh,
Double Eye

Split Lace,
Single Eye

Split Lace,
Double Eye

Description

Heavy-duty support grips feature a double weave mesh and are available in a variety of eye styles and cable ranges for supporting electrical and fiber optic cable, metal rods, and tubing. Support grips are woven of corrosion-resistant tinned-bronze or stainless steel wire.

CATALOG NUMBER TINNED-BRONZE	CATALOG NUMBER STAINLESS STEEL	CABLE DIAMETER RANGE	BALE LENGTH	MESH LENGTH	APPROXIMATE BREAK STRENGTH*
HEAVY-DUTY, CLOSED MESH, SINGLE EYE					
FCHL075U	FCHL075USS	0.750"-0.990"	10"	26"	2,700 lbs.
FCHL100U	FCHL100USS	1.000"-1.240"	10"	29"	4,720 lbs.
FCHL125U	FCHL125USS	1.250"-1.490"	10"	31"	4,720 lbs.
FCHL150U	FCHL150USS	1.500"-1.990"	10"	35"	4,720 lbs.
HEAVY-DUTY, CLOSED MESH, DOUBLE EYE					
FCHL075UU	FCHL075UUSS	0.750"-0.990"	10"	26"	2,700 lbs.
FCHL100UU	FCHL100UUSS	1.000"-1.240"	10"	29"	4,720 lbs.
FCHL125UU	FCHL125UUSS	1.250"-1.490"	10"	31"	4,720 lbs.
FCHL150UU	FCHL150UUSS	1.500"-1.990"	10"	35"	4,720 lbs.
FCHL200UU	FCHL200UUSS	2.000"-2.490"	10"	37"	10,080 lbs.
FCHL250UU	FCHL250UUSS	2.500"-2.990"	10"	39"	10,080 lbs.
FCHL300UU	FCHL300UUSS	3.000"-3.490"	10"	41"	10,080 lbs.
FCHL350UU	FCHL350UUSS	3.500"-3.990"	10"	45"	13,120 lbs.

CATALOG NUMBER TINNED-BRONZE	CATALOG NUMBER STAINLESS STEEL	CABLE DIAMETER RANGE	BALE LENGTH	MESH LENGTH	APPROXIMATE BREAK STRENGTH*
HEAVY-DUTY, SPLIT LACE, SINGLE EYE					
FSHL075U	FSHL075USS	0.750"-0.990"	10"	26"	2,700 lbs.
FSHL100U	FSHL100USS	1.000"-1.240"	10"	29"	4,720 lbs.
FSHL125U	FSHL125USS	1.250"-1.490"	10"	31"	4,720 lbs.
FSHL150U	FSHL150USS	1.500"-1.990"	10"	35"	4,720 lbs.
HEAVY-DUTY, SPLIT LACE, DOUBLE EYE					
FSHL075UU	FSHL075UUSS	0.750"-0.990"	10"	26"	2,700 lbs.
FSHL100UU	FSHL100UUSS	1.000"-1.240"	10"	29"	4,720 lbs.
FSHL125UU	FSHL125UUSS	1.250"-1.490"	10"	31"	4,720 lbs.
FSHL150UU	FSHL150UUSS	1.500"-1.990"	10"	35"	4,720 lbs.
FSHL200UU	FSHL200UUSS	2.000"-2.490"	10"	37"	10,080 lbs.
FSHL250UU	FSHL250UUSS	2.500"-2.990"	10"	39"	10,080 lbs.
FSHL300UU	FSHL300UUSS	3.000"-3.490"	10"	41"	10,080 lbs.
FSHL350UU	FSHL350UUSS	3.500"-3.990"	10"	45"	13,120 lbs.
FSHL400UU	FSHL400UUSS	4.000"-4.490"	10"	47"	13,120 lbs.

*To determine workload safety factor, divide approximate break strength by 10.
See Page K-31 for strength information.

FLEXCOR® WIRE MESH GRIPS

Support Grips Service & Bus Drop



Service Drop Closed Mesh Single Eye



Service Drop Closed Mesh Locking Bale



Bus Drop Closed Mesh Single Eye



Bus Drop Closed Mesh Locking Bale



Bus Drop Accessories

Description

Service drop grips provide support for utility distribution lines from service pole to building or from pole to pole. They can also be used for cable TV and fiber optic cable support. They are woven from tinned bronze wire to provide superior corrosion resistance, and are available in single eye and locking bale configurations.

CATALOG NUMBER	CABLE DIAMETER RANGE	BALE LENGTH	MESH LENGTH	APPROXIMATE BREAK STRENGTH*
SERVICE DROP, CLOSED MESH, SINGLE EYE				
FCSD22	0.220"-0.320"	4"	4"	290 lbs.
FCSD30	0.300"-0.430"	5"	5"	500 lbs.
FCSD40	0.410"-0.560"	6"	5"	500 lbs.
FCSD52	0.530"-0.730"	8"	8"	790 lbs.
FCSD70	0.700"-0.970"	8"	9"	1,020 lbs.
FCSD94	0.940"-1.250"	10"	11"	1,020 lbs.
SERVICE DROP, CLOSED MESH, LOCKING BALE				
FCSD30LB	0.300"-0.430"	11"	5"	500 lbs.
FCSD52LB	0.530"-0.730"	14"	8"	790 lbs.
FCSD70LB	0.700"-0.970"	14"	9"	1,020 lbs.
FCSD94LB	0.940"-1.250"	16"	11"	1,020 lbs.

*To determine workload safety factor, divide approximate break strength by 10. See Page K-31 for strength information.

Description

Bus drop grips are used as cable support. They relieve any direct tension from the critical connection and absorb vibration and flexing. Bus drop grips are woven of galvanized steel wire. They are offered with either the single eye or locking bale attachment.

CATALOG NUMBER	CABLE DIAMETER RANGE	BALE LENGTH	MESH LENGTH	APPROXIMATE BREAK STRENGTH*
BUS DROP, CLOSED MESH, SINGLE EYE				
FC22	0.220"-0.320"	9"	3.5"	1,100 lbs.
FC30	0.300"-0.430"	9"	4.5"	1,100 lbs.
FC40	0.410"-0.560"	9"	5.0"	1,100 lbs.
FC52	0.530"-0.730"	9"	6.5"	1,100 lbs.
FC70	0.700"-0.850"	9"	8.5"	1,900 lbs.
FC94	0.940"-1.250"	9"	11.0"	1,900 lbs.
BUS DROP, CLOSED MESH, LOCKING BALE				
FC30LB	0.300"-0.430"	12"	4.5"	1,100 lbs.
FC40LB	0.410"-0.560"	12"	5.0"	1,100 lbs.
FC52LB	0.530"-0.730"	15"	6.5"	1,100 lbs.
FC70LB	0.700"-0.850"	16"	8.5"	1,900 lbs.
FC94LB	0.940"-1.250"	17"	11.0"	1,900 lbs.

*To determine workload safety factor, divide approximate break strength by 10. See Page K-31 for strength information.

CATALOG NUMBER	NPT SIZE
BUS DROP ACCESSORIES	
S40	Safety Spring, 40 Lb. Load
S80	Safety Spring, 80 Lb. Load
GH5	Support Hook

Most Flexcor products have UL and/or CSA Approvals. Please contact factory for approval information.

FLEXCOR® WIRE MESH PULLING GRIPS

Pulling Grips Junior-Duty & Light-Duty



Junior-Duty Flexible Eye



Light-Duty Short Length Flexible Eye

Description

Junior-duty series grips are indispensable tools for electricians with small job requirements. They are used to connect insulated wire bundles to pulling tape or to pull wire or rope through conduit.

CATALOG NUMBER	CABLE DIAMETER RANGE	MESH LENGTH	APPROXIMATE BREAK STRENGTH*
JUNIOR-DUTY, FLEXIBLE EYE			
PJ25	0.250"-0.360"	5"	1,700 lbs.
PJ37	0.370"-0.490"	7"	1,700 lbs.
PJ50	0.500"-0.610"	8"	1,700 lbs.
PJ62	0.620"-0.740"	10"	2,800 lbs.
PJ75	0.750"-0.990"	10"	4,100 lbs.
PJ100	1.000"-1.240"	12"	4,100 lbs.

*To determine workload safety factor, divide approximate break strength by 5. See Page K-31 for strength information.

Description

Light-Duty grips are the most economical pulling grips for many applications, such as industrial plant wiring, and rewiring, and underground electrical pulls.

CATALOG NUMBER	CABLE DIAMETER RANGE	MESH LENGTH	APPROXIMATE BREAK STRENGTH*
LIGHT-DUTY, SHORT LENGTH, FLEXIBLE EYE			
PL0501	0.500"-0.610"	11"	3,400 lbs.
PL0621	0.620"-0.740"	11"	4,100 lbs.
PL0751	0.750"-0.990"	13"	4,100 lbs.
PL1001	1.000"-1.240"	14"	5,800 lbs.
PL1251	1.250"-1.490"	15"	5,800 lbs.
PL1501	1.500"-1.740"	16"	7,500 lbs.
PL1751	1.750"-1.990"	18"	10,000 lbs.
PL2001	2.000"-2.490"	19"	10,000 lbs.
PL2501	2.500"-2.990"	19"	13,000 lbs.
LIGHT-DUTY, STANDARD LENGTH, FLEXIBLE EYE			
PL0622	0.620"-0.740"	16"	4,100 lbs.
PL0752	0.750"-0.990"	20"	4,100 lbs.
PL1002	1.000"-1.240"	20"	7,500 lbs.
PL1252	1.250"-1.490"	22"	7,500 lbs.
PL1502	1.500"-1.990"	25"	7,500 lbs.
PL2002	2.000"-2.490"	26"	10,000 lbs.
PL2502	2.500"-2.990"	28"	13,000 lbs.
PL3002	3.000"-3.490"	30"	16,200 lbs..

*To determine workload safety factor, divide approximate break strength by 5. See Page K-31 for strength information.



PJ1KIT

CATALOG NUMBER	DESCRIPTION
JUNIOR-DUTY, FLEXIBLE EYE KIT	
PJ1KIT	Kit contains 1 each of PJ25, PJ37, PJ50, PJ62, PJ75, PJ100

FLEXCOR® WIRE MESH PULLING GRIPS

Pulling Grips Medium-Duty



Medium-Duty Flexible Eye



Short Length, Flexible Eye, T-Type

Description

Medium-duty pulling grips are ideal for overhead and underground pulling applications that require additional durability at an economical price. Medium-duty pulling grips are hand crafted with single weave strands that graduate to a double weave design for added strength and durability.

CATALOG NUMBER	CABLE DIAMETER RANGE	MESH LENGTH	APPROXIMATE BREAK STRENGTH*
MEDIUM-DUTY, FLEXIBLE EYE			
PM037	0.370"-0.490"	13"	2,600 lbs.
PM050	0.500"-0.740"	17"	3,400 lbs.
PM075	0.750"-0.990"	20"	5,500 lbs.
PM100	1.000"-1.240"	28"	8,100 lbs.
PM125	1.250"-1.490"	33"	8,100 lbs.
PM150	1.500"-1.740"	36"	8,100 lbs.
MEDIUM-DUTY, LONG LENGTH, FLEXIBLE EYE			
PM0753	0.750"-0.990"	48"	8,100 lbs.
PM1003	1.000"-1.490"	48"	11,600 lbs.
PM1503	1.500"-1.990"	48"	19,400 lbs.
PM2003	2.000"-2.490"	48"	19,400 lbs.
PM2503	2.500"-2.990"	48"	25,900 lbs.
PM3003	3.000"-3.490"	48"	25,900 lbs.
PM3503	3.500"-3.990"	48"	32,400 lbs.

CATALOG NUMBER	DESCRIPTION
MEDIUM-DUTY, FLEXIBLE EYE KIT	
PM1KIT	Kit contains 1 each of PM037, PM050, PM075, PM100, PM125, PM150

*To determine workload safety factor, divide approximate break strength by 5. See Page K-31 for strength information.

CATALOG NUMBER	CABLE DIAMETER RANGE	MESH LENGTH	EYE DIAMETER	APPROXIMATE BREAK STRENGTH*
MEDIUM-DUTY, SHORT LENGTH, FLEXIBLE EYE, T-TYPE				
PM0501	0.500"-0.610"	21"	7/32"	4,500 lbs.
PM0751	0.750"-0.990"	24"	1/4"	6,800 lbs.
PM1001	1.000"-1.490"	24"	5/16"	9,600 lbs.
PM1501	1.500"-1.990"	24"	7/16"	16,400 lbs.
PM2001	2.000"-2.490"	24"	7/16"	18,500 lbs.
PM2501	2.500"-2.990"	24"	1/2"	24,500 lbs.
PM3001	3.000"-3.490"	24"	1/2"	24,500 lbs.
PM3501	3.500"-3.990"	26"	5/8"	31,000 lbs.
MEDIUM-DUTY, STANDARD LENGTH, FLEXIBLE EYE, T-TYPE				
PM0752	0.750"-0.990"	36"	1/4"	6,800 lbs.
PM1002	1.000"-1.490"	36"	5/16"	9,600 lbs.
PM1502	1.500"-1.990"	36"	7/16"	16,400 lbs.
PM2002	2.000"-2.490"	36"	7/16"	18,500 lbs.
PM2502	2.500"-2.990"	36"	1/2"	24,500 lbs.
PM3002	3.000"-3.490"	36"	1/2"	24,500 lbs.
PM3502	3.500"-3.990"	40"	5/8"	31,000 lbs.

*To determine workload safety factor, divide approximate break strength by 5. See Page K-31 for strength information.

Most Flexcor products have UL and/or CSA Approvals. Please contact factory for approval information.

FLEXCOR® WIRE MESH PULLING GRIPS

Pulling Grips Heavy-Duty



Short Length, Rotating Eye, K-Type

Description

K-type pulling grips feature a double weave of galvanized steel for greater strength and added mesh contact with the cable as well as a forged steel compact rotating eye, which can be attached to a swivel. They are designed to handle longer or heavier pulling jobs such as an installation of underground cables, communication lines and service lines.

CATALOG NUMBER	CABLE DIAMETER RANGE	MESH LENGTH	EYE DIAMETER	APPROXIMATE BREAK STRENGTH*
HEAVY-DUTY, SHORT LENGTH, ROTATING EYE, K-TYPE				
PS0501	0.500"-0.610"	11"	7/8"	5,600 lbs.
PS0751	0.750"-0.990"	20"	1"	9,600 lbs.
PS1001	1.000"-1.240"	20"	1-3/8"	16,400 lbs.
PS1251	1.250"-1.490"	21"	1-3/8"	16,400 lbs.
PS1501	1.500"-1.990"	25"	1-5/8"	27,200 lbs.
PS2001	2.000"-2.490"	26"	1-7/8"	33,000 lbs.
PS2501	2.500"-2.990"	28"	1-7/8"	41,000 lbs.
PS3001	3.000"-3.490"	30"	1-7/8"	48,000 lbs.
PS3501	3.500"-3.990"	32"	1-7/8"	48,000 lbs.
PS4001	4.000"-4.490"	33"	1-7/8"	48,000 lbs.
HEAVY-DUTY, STANDARD LENGTH, ROTATING EYE, K-TYPE				
PS0502	0.500"-0.610"	16"	7/8"	5,600 lbs.
PS0622	0.620"-0.740"	16"	7/8"	6,800 lbs.
PS0752	0.750"-0.990"	32"	1"	9,600 lbs.
PS1002	1.000"-1.490"	33"	1-3/8"	16,400 lbs.
PS1502	1.500"-1.990"	34"	1-3/8"	16,400 lbs.
PS2002	2.000"-2.490"	36"	1-5/8"	27,200 lbs.
PS2502	2.500"-2.990"	38"	1-7/8"	33,000 lbs.
PS3002	3.000"-3.490"	39"	1-7/8"	41,000 lbs.
PS3502	3.500"-3.990"	41"	1-7/8"	48,000 lbs.
PS4002	4.000"-4.490"	42"	1-7/8"	48,000 lbs.
PS4502	4.500"-4.990"	58"	1-7/8"	48,000 lbs.

*To determine workload safety factor, divide approximate break strength by 5.
See Page K-31 for strength information.

FLEXCOR® WIRE MESH PULLING GRIPS

Pulling Grips Multi-Weave



Multi-Weave Flexible Eye



Multi-Weave Rotating Eye

Description – Multi-Weave

Multi-weave pulling grips are constructed of high strength galvanized steel and are designed for pulling aluminum or copper bare conductor, wire rope and insulated cables. These grips are used in applications such as distribution line stringing and overhead transmission. Multi-weave pulling grips are available with a flexible and rotating eye, which can be attached to a swivel.

Description – Rotating Eye

The forged steel rotating eye will thread through sheaves and blocks without binding, but is not a swivel and will not turn under tension. The rotating eye can turn to relieve pulling torque when tension is relaxed.

CATALOG NUMBER	CABLE DIAMETER RANGE	MESH LENGTH	EYE DIAMETER	APPROXIMATE BREAK STRENGTH*	COLOR CODE
MULTI-WEAVE, ROTATING EYE					
P0501	0.500"-0.740"	32"	1"	10,000 lbs.	Brown
P0751	0.750"-0.990"	41"	1"	14,400 lbs.	Lt Blue
P1001	1.000"-1.240"	52"	1-3/8"	24,600 lbs.	Gold
P1501	1.500"-1.740"	60"	1-7/8"	30,600 lbs.	Red
P2001	2.000"-2.490"	50"	1-7/8"	48,000 lbs.	Yellow
P2501	2.500"-2.990"	52"	1-7/8"	48,000 lbs.	Orange
P3001	3.000"-3.490"	54"	1-7/8"	48,000 lbs.	Aluminum
P3501	3.500"-3.990"	56"	1-7/8"	48,000 lbs.	Lt Green
MULTI-WEAVE, FLEXIBLE EYE					
P0752	0.750"-0.990"	41"	3/8"	14,400 lbs.	Lt Blue
P1002	1.000"-1.240"	52"	1/2"	24,600 lbs.	Gold
P1502	1.500"-1.740"	60"	1/2"	30,600 lbs.	Red
P2002	2.000"-2.490"	50"	5/8"	48,000 lbs.	Yellow
P2502	2.500"-2.990"	52"	5/8"	48,000 lbs.	Orange
P3002	3.000"-3.490"	54"	5/8"	48,000 lbs.	Aluminum
P3502	3.500"-3.990"	56"	5/8"	48,000 lbs.	Lt Green

*To determine workload safety factor, divide approximate break strength by 5. See Page K-31 for strength information.

NOTE: it is recommended that a swivel be used for release of torque during a pull. Use a connecting link when a swivel is not needed. Do not run grips or swivels over bullwheels while under tension. Do not use multi-weave for pulling rope. When higher loads are required, use Pass & Seymour® high strength-style pulling grips. See installation instructions supplied with grip for recommended swivels, links and clamps or accessories listing.

FLEXCOR® WIRE MESH PULLING GRIPS

Pulling Grips High Strength

Description

High strength pulling grips are designed for situations where loads and safety considerations require an extra high strength grip. They are most commonly used for attaching pulling lines to conductors, conductors to running boards and conductor-to-conductor connections. These grips can be used for pulling bare or insulated conductor, wire rope or synthetic rope.

CATALOG NUMBER	CABLE DIAMETER RANGE*	MESH LENGTH	APPROXIMATE BREAK STRENGTH**	COLOR CODE
FLEXIBLE EYE HIGH STRENGTH DOUBLE WEAVE				
MSP025	0.250"-0.650"	24"	6,800 lbs.	Black
MSP050	0.500"-0.900"	36"	10,000 lbs.	Dark Green
MSP075	0.750"-1.100"	48"	14,400 lbs.	Red
MSP100	1.000"-1.500"	60"	24,600 lbs.	Dark Blue
MSP125	1.250"-1.700"	76"	30,600 lbs.	Yellow
MSP150	1.500"-2.100"	89"	30,600 lbs.	Aluminum

*For rope, select smallest size grip which meets required workload.

**To determine workload safety factor, divide approximate break strength by 5.
See Page K-31 for strength information.

Rope Assembly Using High Strength Feed Tube

A feed tube is recommended when assembling synthetic rope into the High Strength Pulling Grip and is required on the two largest grip sizes.

1. Insert feed tube into high strength pulling grip.
2. Insert rope end fully into feed tube.
3. Hold rope in feed tube by pinning rope to the ground with end of tube. Pull mesh down onto feed so feed tube nose is protruding through shoulder protectors.
4. Push mesh to end of feed tube and pull feed tube through mesh. When pulled, the mesh gripping action will hold rope in place.
5. Position rope so that its end is inside the shoulder protectors. Remove slack by smoothing mesh tight to rope.
6. Apply clamps to mesh end as necessary.



High Strength Flexible Eye

FLEXCOR® WIRE MESH PULLING GRIPS

Pulling Grips Slack



Double Weave, Standard Length,
Closed Mesh, Offset Eye



Double Weave, Standard Length,
Split Lace, Offset Eye



Single Weave, Standard
Length, Split Rod, Offset Eye

Description

Slack grips are reusable grips used for pulling slack in underground cable preparatory to final placement. They may also be used for cable removal. Slack grips feature an offset eye for easy attachment to the pulling line.

CATALOG NUMBER	CABLE DIAMETER RANGE	MESH LENGTH	APPROXIMATE BREAK STRENGTH*
DOUBLE WEAVE, STANDARD LENGTH, CLOSED MESH, OFFSET EYE			
SCK0751	0.750"-0.990"	13"	3,000 lbs.
SCK1001	1.000"-1.240"	16"	4,200 lbs.
SCK1251	1.250"-1.490"	17"	5,500 lbs.
SCK1501	1.500"-1.740"	18"	7,400 lbs.
SCK1751	1.750"-1.990"	19"	11,000 lbs.
SCK2501	2.500"-2.990"	21"	11,000 lbs.
SCK3001	3.000"-3.490"	22"	16,000 lbs.
SCK3501	3.500"-3.990"	23"	16,000 lbs.
DOUBLE WEAVE, LONG LENGTH, CLOSED MESH, OFFSET EYE			
SCK1502	1.500"-1.740"	26"	7,400 lbs.
SCK2002	2.000"-2.490"	27"	11,000 lbs.
SCK2502	2.500"-2.990"	30"	11,000 lbs.
SCK3002	3.000"-3.490"	33"	16,000 lbs.
DOUBLE WEAVE, STANDARD LENGTH, SPLIT LACE, OFFSET EYE			
SSK0751	0.750"-0.990"	13"	3,000 lbs.
SSK1251	1.250"-1.490"	17"	4,100 lbs.
SSK1501	1.500"-1.740"	18"	5,500 lbs.
SSK1751	1.750"-1.990"	19"	7,300 lbs.
SSK2001	2.000"-2.490"	20"	7,300 lbs.
SSK3001	3.000"-3.490"	22"	9,200 lbs.
SSK3501	3.500"-3.990"	23"	11,000 lbs.
DOUBLE WEAVE, LONG LENGTH, SPLIT LACE, OFFSET EYE			
SSK1002	1.000"-1.240"	21"	4,100 lbs.
SSK1252	1.250"-1.490"	24"	4,100 lbs.
SSK1502	1.500"-1.740"	25"	5,500 lbs.
SSK2002	2.000"-2.490"	27"	7,300 lbs.
SSK2502	2.500"-2.990"	30"	7,300 lbs.
SSK3002	3.000"-3.490"	33"	9,200 lbs.
DOUBLE WEAVE, STANDARD LENGTH, SPLIT LACE, OFFSET EYE			
SRK0500F	0.500"-0.610"	7"	1,800 lbs.
SRK0620F	0.620"-0.740"	9"	1,900 lbs.
SRK0750F	0.750"-0.990"	11"	3,000 lbs.
SRK1000F	1.000"-1.240"	12"	4,100 lbs.
SRK1250F	1.250"-1.490"	14"	5,700 lbs.
SRK1500F	1.500"-1.740"	16"	5,800 lbs.
SRK1750F	1.750"-1.990"	17"	7,700 lbs.
SRK2000F	2.000"-2.490"	20"	9,300 lbs.
SRK2500F	2.500"-2.990"	21"	11,300 lbs.
SRK3000F	3.000"-3.490"	22"	15,100 lbs.
SRK3500F	3.500"-3.990"	25"	15,100 lbs.

*To determine workload safety factor, divide approximate break strength by 5.

See Page K-31 for strength information.

Most Flexcor products have UL and/or CSA Approvals.

Please contact factory for approval information.

FLEXCOR® WIRE MESH GRIPS

Selecting Properly Sized Pulling & Support Grips

Select grip size based upon the outside diameter or circumference of the cable(s). See the following reference tables for convenience in determining cable diameters.

Use the following grip selection tables to determine the grip diameter range for your application.

Grip selection for one or more cables of equal diameter

1. Read across top line for number of cables in one grip.
2. Read down for diameter of each cable.
3. Read across to the right to grip diameter range column.

Example: For five cables together with diameter of 0.42" each

1. Locate "5 cables" column.
2. Read down column to range (0.38"-0.48").
3. Read across line to grip diameter range (1.00"-1.25").

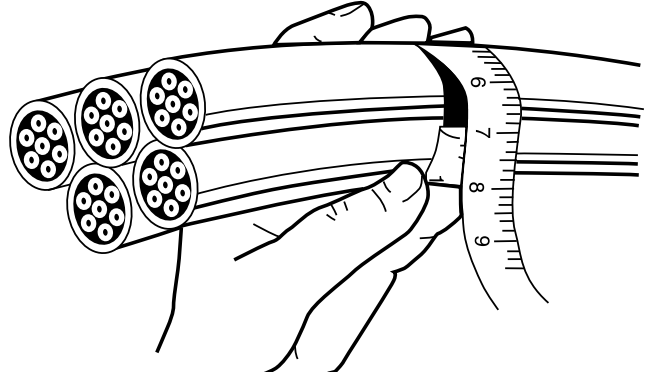

DECIMAL & FRACTIONAL INCH CABLE DIAMETERS – FOR ONE OR MORE CABLES OF EQUAL DIAMETER

1 CABLE	2 CABLE	3 CABLE	4 CABLE	GRIP DIAMETER RANGE
0.25-0.37 = 1/4 - 3/8	0.16-0.25 = 1/64 - 1/4	0.15-0.22 = 5/32 - 7/32	0.12-0.20 = 1/8 - 13/64	0.25"-0.375"
0.37-0.50 = 3/8 - 1/2	0.25-0.36 = 1/4 - 23/64	0.22-0.33 = 7/32 - 21/64	0.20-0.28 = 13/64 - 9/32	0.375"-0.50"
0.50-0.62 = 1/2 - 5/8	0.27-0.36 = 17/64 - 23/64	0.26-0.33 = 17/64 - 21/64	0.24-0.28 = 15/64 - 9/32	0.50"-0.62"
0.62-0.75 = 5/8 - 3/4	0.36-0.45 = 23/64 - 29/64	0.33-0.36 = 21/64 - 23/64	0.28-0.31 = 9/32 - 5/16	0.62"-0.75"
0.75-1.00 = 3/4 - 1	0.45-0.60 = 29/64 - 39/64	0.36-0.49 = 23/64 - 31/64	0.31-0.42 = 5/16 - 27/64	0.75"-1.00"
1.00-1.25 = 1 - 1 1/4	0.60-0.76 = 39/64 - 49/64	0.49-0.63 = 31/64 - 5/8	0.42-0.54 = 27/64 - 35/64	1.00"-1.25"
1.25-1.50 = 1 1/4 - 1 1/2	0.76-0.91 = 49/64 - 29/32	0.63-0.75 = 5/8 - 49/64	0.54-0.65 = 35/64 - 21/32	1.25"-1.50"
1.50-1.75 = 1 1/2 - 1 3/4	0.91-1.23 = 29/32 - 115/64	0.76-0.89 = 49/64 - 57/64	0.65-0.77 = 21/32 - 49/64	1.50"-1.75"
1.75-2.00 = 1 3/4 - 2	1.23-1.54 = 115/64 - 1 35/64	0.89-1.02 = 57/64 - 1 1/64	0.77-0.88 = 49/64 - 7/8	1.75"-2.00"
2.00-2.50 = 2 - 2 1/2	1.54-1.84 = 1 35/64 - 1 27/32	1.02-1.28 = 1 1/64 - 1 9/32	0.88-1.00 = 7/8 - 1	2.00"-2.50"
2.50-3.00 = 2 1/2 - 3	1.84-2.15 = 1 27/32 - 2 5/32	1.28-1.53 = 1 9/32 - 1 11/32	1.10-1.32 = 1 3/32 - 1 21/64	2.50"-3.00"
3.00-3.50 = 3 - 3 1/2	2.15-2.45 = 2 5/32 - 2 29/64	1.53-1.79 = 1 17/32 - 1 51/64	1.32-1.54 = 1 21/64 - 1 35/64	3.00"-3.50"
3.50-4.00 = 3 1/2 - 4		1.79-2.05 = 1 51/64 - 2 3/64	1.54-1.76 = 1 35/64 - 1 49/64	3.50"-4.00"

DECIMAL & FRACTIONAL INCH CABLE DIAMETERS – FOR ONE OR MORE CABLES OF EQUAL DIAMETER

5 CABLE	6&7 CABLE	8 CABLE	9 CABLE	GRIP DIAMETER RANGE
0.11-0.14 = 7/64 - 9/64	0.10-0.11 = 3/32 - 7/64	0.09-0.10 = 3/32 - 7/64	0.06-0.09 = 1/16 - 3/32	0.25"-0.375"
0.14-0.21 = 9/64 - 1/4	0.11-0.25 = 7/64 - 1/4	0.10-0.20 = 7/64 - 13/64	0.09-0.19 = 3/32 - 3/16	0.375"-0.50"
0.21-0.25 = 7/32 - 1/4	0.19-0.22 = 3/16 - 7/32	0.17-0.20 = 11/64 - 13/64	0.15-0.19 = 5/32 - 3/16	0.50"-0.62"
0.25-0.29 = 1/4 - 19/64	0.22-0.26 = 7/32 - 17/64	0.20-0.23 = 13/64 - 15/64	0.19-0.22 = 3/16 - 7/32	0.62"-0.75"
0.29-0.38 = 19/64 - 3/8	0.26-0.34 = 17/64 - 11/32	0.23-0.31 = 15/64 - 5/16	0.22-0.31 = 7/32 - 5/16	0.75"-1.00"
0.38-0.48 = 3/8 - 31/64	0.34-0.43 = 11/32 - 7/16	0.31-0.39 = 5/16 - 25/64	0.29-0.36 = 19/64 - 23/64	1.00"-1.25"
0.48-0.58 = 31/64 - 41/64	0.43-0.52 = 7/16 - 33/64	0.39-0.46 = 25/64 - 15/32	0.36-0.43 = 23/64 - 7/16	1.25"-1.50"
0.58-0.67 = 37/64 - 43/64	0.52-0.60 = 33/64 - 39/64	0.46-0.54 = 15/32 - 35/64	0.43-0.49 = 7/16 - 31/64	1.50"-1.75"
0.67-0.77 = 43/64 - 49/64	0.60-0.69 = 39/64 - 11/16	0.54-0.62 = 35/64 - 5/8	0.49-0.57 = 31/64 - 37/64	1.75"-2.00"
0.77-0.96 = 49/64 - 31/32	0.69-0.86 = 11/16 - 55/64	0.62-0.77 = 5/8 - 49/64	0.57-0.72 = 37/64 - 23/32	2.00"-2.50"
0.96-1.16 = 31/32 - 15/32	0.86-1.03 = 55/64 - 11/32	0.77-0.93 = 49/64 - 151/64	0.72-0.86 = 23/32 - 55/64	2.50"-3.00"
1.16-1.35 = 15/32 - 1 23/64	1.03-1.20 = 11/32 - 1 13/64	0.93-1.08 = 15/16 - 15/64	0.86-1.00 = 55/64 - 1	3.00"-3.50" w
1.35-1.54 = 1 23/64 - 1 35/64	1.20-1.37 = 1 13/64 - 1 3/8	1.08-1.24 = 15/64 - 1 15/64	1.00-1.14 = 1 - 1/64	3.50"-4.00"

FLEXCOR® WIRE MESH GRIPS

FLEXCOR® WIRE MESH GRIPS

Selecting Properly Sized Pulling & Support Grips

Grip circumference range refers to circumference of all cables held together.

1. Determine grip circumference range by measuring circumference of bundle of cables to be held (as shown in illustration).
2. Read down to locate correct range.
3. Read across to grip diameter column.

Example: For three cables together with combined circumference of 6.35"

1. Read down "inches (decimal)" column for 6.35" (6.29"-7.86").
2. Read across line to grip diameter range (2.00"-2.50").

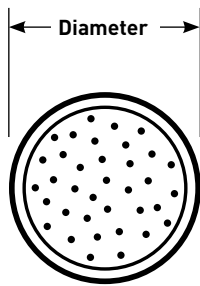
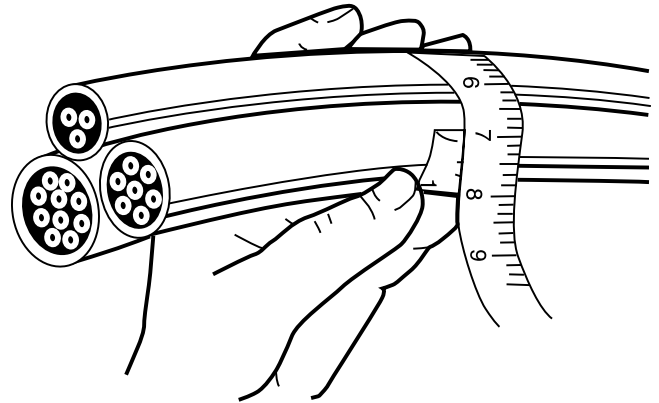

AWG OR MCM WIRE SIZES			
AWG OR MCM	APPROX. DIA. THHM	APPROX. DIA. THW	
14	0.105"	0.162"	
12	0.122"	0.179"	
10	0.153"	0.199"	
8	0.201"	0.259"	
6	0.257"	0.323"	
4	0.328"	0.372"	
3	0.356"	0.401"	
2	0.388"	0.433"	
1	0.450"	0.508"	
1/0	0.491"	0.549"	
2/0	0.537"	0.595"	
3/0	0.588"	0.647"	
4/0	0.646"	0.705"	
250	0.716"	0.788"	
300	0.771"	0.843"	
350	0.822"	0.895"	
400	0.869"	0.942"	
500	0.955"	1.03"	
600	1.06"	1.14"	
700	1.13"	1.21"	
750	1.16"	1.25"	
1000	1.32"	1.40"	

GRIP CABLE RANGE CONVERSION		
INCHES (FRACTIONAL)	INCHES (DECIMAL)	GRIP DIAMETER RANGE
25/32 - 11/64"	0.78"-1.17"	0.25"-0.375"
11/64 - 137/64"	1.17"-1.57"	0.375"-0.50"
137/64 - 23/8"	1.57"-2.37"	0.50"-0.75"
15/16 - 23/8"	1.94"-2.37"	0.625"-0.75"
23/8 - 35/32"	2.37"-3.15"	0.75"-1.00"
35/32 - 315/16"	3.15"-3.94"	1.00"-1.25"
315/16 - 4"	3.94"-4.72"	1.25"-1.50"
423/32 - 533/64"	4.72"-5.51"	1.50"-1.75"
533/64 - 619/64"	5.51"-6.29"	1.75"-2.00"
619/64 - 755/64"	6.29"-7.86"	2.00"-2.50"
755/64 - 97/16"	7.86"-9.43"	2.50"-3.00"
97/16 - 111/64"	9.43"-11.01"	3.00"-3.50"
111/64 - 1237/64"	11.01"-12.58"	3.50"-4.00"

This table to be used as a guide only. Sizes may vary by manufacturer.

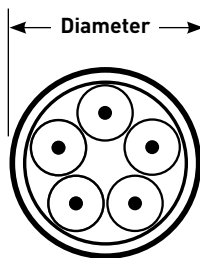

REFERENCE TABLE: CORD DIAMETERS				
AVERAGE WIRE SIZE AND TYPE	2 CONDUCTORS	3 CONDUCTORS	4 CONDUCTORS	5 CONDUCTORS
18 SO, STO	0.36"	0.38"	0.41"	0.49"
18 SJO, SJTO	0.30"	0.32"	0.35"	—
16 SO, STO	0.39"	0.41"	0.44"	0.52"
16 SJO, SJTO	0.32"	0.34"	0.37"	—
14 SO, STO	0.52"	0.55"	0.59"	0.67"
12 SO, STO	0.60"	0.62"	0.68"	0.74"
10 SO, STO	0.65"	0.69"	0.74"	0.80"
8 SO, STO	0.83"	0.88"	0.99"	1.08"
6 SO, STO	0.99"	1.04"	1.12"	1.25"

Nominal overall diameters (in inches) for flexible cord.

FLEXCOR® WIRE MESH GRIPS

Pulling & Support Grips Strength Information

Strength Information

The approximate breaking strength of any Pass & Seymour wire mesh cable grip is based on working load information established by Legrand engineering laboratories. In making these determinations, it is not possible to cover all applications and operating conditions. Variables such as diameters, gripping surfaces, number of items gripped, tension, movement, attachment, abrasion, corrosion, prior use, or abuse must be assessed by the user. Greater safety factors should be utilized when the conditions of application are vague or unknown.

For specific applications where strength and holding power are important, consult the manufacturer. To determine the recommended working load safety factor for listed cable grips, divide the approximate breaking strength by 5 for pulling grips and 10 for support grips. Legrand maintains a 6 sigma safety factor for pulling grips and a 5 sigma safety factor for support grips for these recommended working loads (using average break strengths obtained on new grips under lab test conditions).

Example: For pulling grips – $33,000 \div 5 = 6,600$ lbs. which is the workload factor.

Example: For support grips – $10,080 \div 10 = 1,008$ lbs. which is the workload factor.

All warranties concerning product quality or performance are based on wire mesh grips that are properly stored and handled by the user, and grips that are maintained and inspected at a proper frequency in keeping with their use and condition.

GRIP CABLE RANGE CONVERSION

INCHES (FRACTIONAL)	INCHES (DECIMAL)	GRIP DIAMETER RANGE
1/4 - 23/64"	0.25"-0.36"	6.35 mm-9.13 mm
3/8 - 31/64"	0.37"-0.49"	9.52 mm-12.30 mm
1/2 - 39/64"	0.50"-0.61"	12.70 mm-15.48 mm
5/8 - 47/64"	0.62"-0.74"	15.88 mm-18.65 mm
3/4 - 63/64"	0.75"-0.99"	19.05 mm-25.00 mm
1 - 115/64"	1.00"-1.24"	25.40 mm-31.35 mm
1 1/4 - 131/64"	1.25"-1.49"	31.75 mm-37.70 mm
1 1/2 - 163/64"	1.50"-1.99"	38.10 mm-50.40 mm
2 - 231/64"	2.00"-2.49"	50.80 mm-63.10 mm
2 1/2 - 263/64"	2.50"-2.99"	63.50 mm-75.80 mm
3 - 331/64"	3.00"-3.49"	76.20 mm-88.50 mm
3 1/2 - 363/64"	3.50"-3.99"	88.90 mm-101.20 mm

RUBBER & WATERTIGHT DEVICES



Featured Products	 <p>RUBBER DUST-TIGHT PLUGS & CONNECTORS L-2</p>	 <p>WATERTIGHT PLUGS, CONNECTORS & RECEPTACLES L-4</p>	 <p>STERIGUARD™ ANTIMICROBIAL PLUGS, CONNECTORS & CORD DROPS L-10</p>
--------------------------	--	---	---

Rubber Dust-Tight Plugs & Connectors – Straight Blade & Turnlok®	L-2
Watertight Plugs, Connectors & Receptacles – Straight Blade & Turnlok®	L-4
Watertight Back Boxes	L-7

Portable Outlet Boxes & Covers	L-8
SteriGuard™ Antimicrobial Devices – Straight Blade & Turnlok®	L-10
Product Specifications & Performance	L-13

RUBBER & WATERTIGHT DEVICES

Rubber Dust-Tight Plugs & Connectors 2 Pole, 3 Wire Grounding 15 & 20A, 125 & 250V

1447 & 1547

Rubber Dust-Tight Plugs & Connectors

A. Industrial-strength brass blades and contacts for long-lasting conductivity.

B. Rubber body construction stands up to impacts, oils, chemicals, heat, and weather.

C. Quick-drive assembly screws allow for fast installation, saving time and money.

Terminal screws backed-out, ready-to-wire, saving time and money.

Self-centering cord clamps provide superior strain relief.

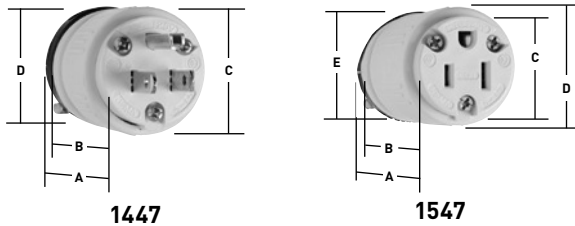
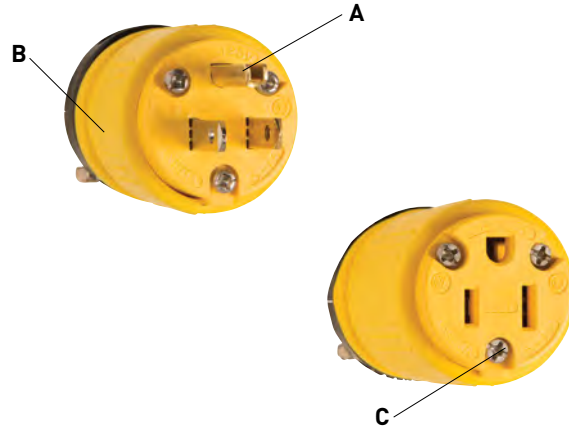

CATALOG NUMBER	RATING		DESCRIPTION	NEMA CONFIG. NO.	3rd PARTY COMPLIANCE	
	A.	V.			UL498	C22.2 No. 42M
RUBBER DUSTTIGHT PLUGS & CONNECTORS						
1447	15	125	Plug, Yellow, Rubber	5-15P	•	•
1547	15	125	Connector, Yellow, Rubber	5-15R	•	•
1433P	20	125	Plug, Yellow, Rubber	5-20P	•	•
1533	20	125	Connector, Yellow, Rubber	5-20R	•	•
1449	15	250	Plug, Yellow, Rubber	6-15P	•	•
1549	15	250	Connector, Yellow, Rubber	6-15R	•	•
1448	20	250	Plug, Yellow, Rubber	6-20P	•	•
1548	20	250	Connector, Yellow, Rubber	6-20R	•	•

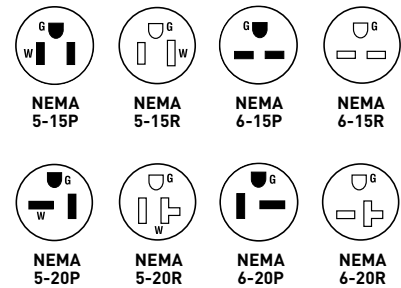

(INCH)	A	B	C	D	E
RUBBER STRAIGHT BLADE PLUG					
15A	2.27"	1.44"	1.53"	1.53"	
20A	2.59"	1.76"	1.93"	1.60"	
RUBBER STRAIGHT BLADE CONNECTOR					
15A	2.99"	2.16"	1.53"	1.66"	1.53"
20A	3.74"	2.19"	1.93"	2.07"	1.60"

Cord Grip Range: .335"-.640"

RUBBER & WATERTIGHT DEVICES

IP20
Suitability

Rubber Dust-Tight Turnlok® Plugs & Connectors 2 Pole, 3 Wire Grounding 15 & 20A, 125, 250 & 277V
3 Pole, 4 Wire Grounding 20 & 30A, 125/250, 3ø250, 3ø480, 3ø600V; 3 Pole, 3 Wire 20A, 125/250V



2647



2747

Features

- Industrial-strength brass blades & contacts for long-lasting superior corrosion resistance.
- Thermoplastic elastomer construction stands up to impacts oils, chemicals, heat and weather.
- Quick-drive assembly screws allow for fast installation, saving time and money.
- Two-screw self-centering cable clamp secures wire and provides superior strain relief.
- Recessed assembly screws are isolated from live parts.
- Keyed body & cover for easy assembly and alignment.

CATALOG NUMBER	RATING		DESCRIPTION	NEMA CONFIG. NO.	3rd PARTY COMPLIANCE	
	A.	V.			UL498	C22.2 No. 42M
RUBBER DUSTTIGHT PLUGS & CONNECTORS						
2447	15	125	Plug, Yellow, Rubber	L5-15P	•	•
2547	15	125	Connector, Yellow, Rubber	L5-15R	•	•
2647	20	125	Plug, Yellow, Rubber	L5-20P	•	•
2747	20	125	Connector, Yellow, Rubber	L5-20R	•	•
2847	30	125	Plug, Yellow, Rubber	L5-30P	•	•
2947	30	125	Connector, Yellow, Rubber	L5-30R	•	•
2449	15	250	Plug, Yellow, Rubber	L6-15P	•	•
2549	15	250	Connector, Yellow, Rubber	L6-15R	•	•
2648	20	250	Plug, Yellow, Rubber	L6-20P	•	•
2748	20	250	Connector, Yellow, Rubber	L6-20R	•	•
2848	30	250	Plug, Yellow, Rubber	L6-30P	•	•
2948	30	250	Connector, Yellow, Rubber	L6-30R	•	•
2434	15	277	Plug, Yellow, Rubber	L7-15P	•	•
2534	15	277	Connector, Yellow, Rubber	L7-15R	•	•
2649	20	277	Plug, Yellow, Rubber	L7-20P	•	•
2749	20	277	Connector, Yellow, Rubber	L7-20R	•	•
2849	30	277	Plug, Yellow, Rubber	L7-30P	•	•
2949	30	277	Connector, Yellow, Rubber	L7-30R	•	•
2674	20	125/250	Plug, Yellow, Rubber	L14-20P	•	•
2774	20	125/250	Connector, Yellow, Rubber	L14-20R	•	•
2874	30	125/250	Plug, Yellow, Rubber	L14-30P	•	•
2974	30	125/250	Connector, Yellow, Rubber	L14-30R	•	•
2675	20	3ø250	Plug, Yellow, Rubber	L15-20P	•	•
2775	20	3ø250	Connector, Yellow, Rubber	L15-20R	•	•
2875	30	3ø250	Plug, Yellow, Rubber	L15-30P	•	•
2975	30	3ø250	Connector, Yellow, Rubber	L15-30R	•	•
2676	20	3ø480	Plug, Yellow, Rubber	L16-20P	•	•
2776	20	3ø480	Connector, Yellow, Rubber	L16-20R	•	•
2876	30	3ø480	Plug, Yellow, Rubber	L16-30P	•	•
2976	30	3ø480	Connector, Yellow, Rubber	L16-30R	•	•
2877	30	3øY 600	Plug, Yellow, Rubber	L17-30P	•	•
2977	30	3øY 600	Connector, Yellow, Rubber	L17-30R	•	•
2608	20	125/250	Plug, Yellow, Rubber	NON	•	•
2708	20	125/250	Connector, Yellow, Rubber	NON	•	•

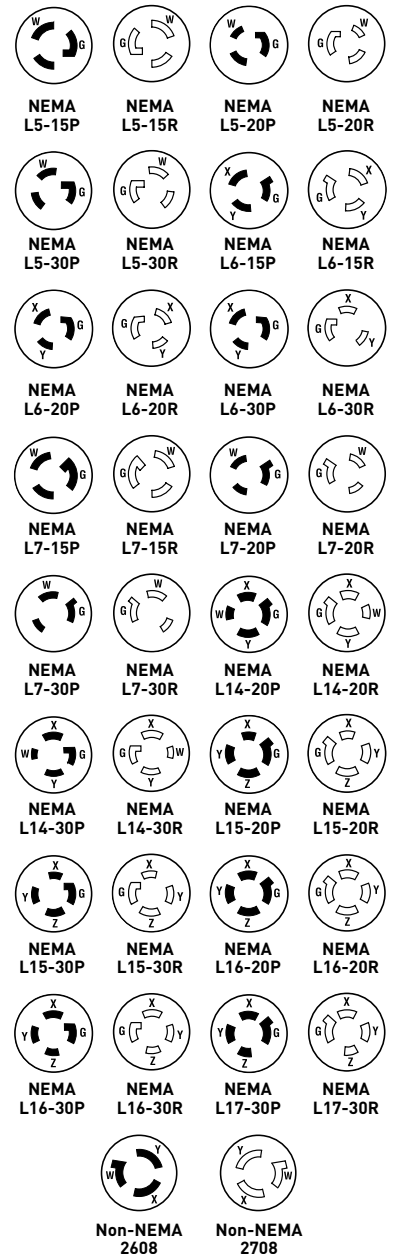

RUBBER & WATERTIGHT DEVICES

RUBBER & WATERTIGHT DEVICES

IP67
Suitability

Watertight Plugs, Connectors & Receptacles 2 Pole, 3 Wire Grounding 15 & 20A, 125 & 250V

15W47 & 14W47

Watertight Plugs, Connectors & Receptacles

- A. Rubber body construction** stands up to impacts, oils, chemicals, heat, and weather.
- B. Floating blades** allow self-alignment with contacts for a firm, even electrical connection.
- C. Quick-drive assembly screws** allow for fast installation, saving time and money.
- D. Nickel-plated blades and contacts** for long-lasting, superior corrosion resistance.

NEMA 4, 4X, Watertight. IP65, 66, 67. Rated watertight for 1,500 psi high-pressure hose-down.



Terminal screws backed-out, ready-to-wire, saving time and money.

Multiple ring seals between plug and connector ensures protection from water and contaminants.

Compression-type cord grip provides watertight seal and 205 lb. pull out strength.

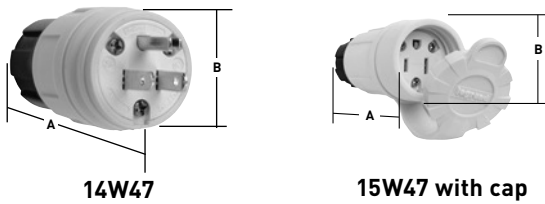

(INCH)	A	B
WATERTIGHT PLUG		
15A	2.62"	1.85"
20A	2.62"	1.85"
WATERTIGHT CONNECTOR		
15A	4.03"	1.85"
20A	4.03"	1.85"



60W33DPLX

Cord Grip Range: .250"-.625"

CATALOG NUMBER	RATING		DESCRIPTION	NEMA CONFIG. NO.	3rd PARTY COMPLIANCE	
	A.	V.			UL498	C22.2 No. 42M
WATERTIGHT PLUGS, CONNECTORS & RECEPTACLES						
14W47	15	125	Plug, Yellow, NEMA 4X/6P	5-15P	•	•
14W47BK	15	125	Plug, Black, NEMA 4X/6P	5-15P	•	•
14W47GCM	15	125	Plug, Yellow, NEMA 4X/6P, Ground Continuity Monitoring	5-15P	•	•
15W47	15	125	Connector, Yellow, NEMA 4X/6P	5-15R	•	•
15W47BK	15	125	Connector, Black, NEMA 4X/6P	5-15R	•	•
15W47GCM	15	125	Connector, Yellow, NEMA 4X/6P, Ground Continuity Monitoring	5-15R	•	•
60W47	15	125	Single Receptacle, Yellow, NEMA 4X/6P	5-15R	•	•
60W47BK	15	125	Single Receptacle, Black, NEMA 4X/6P	5-15R	•	•
60W47DPLX	15	125	Duplex Receptacle, Yellow, NEMA 4X/6P	5-15R	•	•
14W33	20	125	Plug, Yellow, NEMA 4X/6P	5-20P	•	•
14W33BK	20	125	Plug, Black, NEMA 4X/6P	5-20P	•	•
14W33GCM	20	125	Plug, Yellow, NEMA 4X/6P, Ground Continuity Monitoring	5-20P	•	•
15W33	20	125	Connector, Yellow, NEMA 4X/6P	5-20R	•	•
15W33BK	20	125	Connector, Black, NEMA 4X/6P	5-20R	•	•
15W33GCM	20	125	Connector, Yellow, NEMA 4X/6P, Ground Continuity Monitoring	5-20R	•	•
60W33	20	125	Single Receptacle, Yellow, NEMA 4X/6P	5-20R	•	•
60W33DPLX	20	125	Duplex Receptacle, Yellow, NEMA 4X/6P	5-20R	•	•
14W49	15	250	Plug, Yellow, NEMA 4X/6P	6-15P	•	•
14W49BK	15	250	Plug, Black, NEMA 4X/6P	6-15P	•	•
15W49	15	250	Connector, Yellow, NEMA 4X/6P	6-15R	•	•
15W49BK	15	250	Connector, Black, NEMA 4X/6P	6-15R	•	•
60W49	15	250	Single Receptacle, Yellow, NEMA 4X/6P	6-15R	•	•
60W49DPLX	15	250	Duplex Receptacle, Yellow, NEMA 4X/6P	6-15R	•	•
14W48	20	250	Plug, Yellow, NEMA 4X/6P	6-20P	•	•
14W48BK	20	250	Plug, Black, NEMA 4X/6P	6-20P	•	•
15W48	20	250	Connector, Yellow, NEMA 4X/6P	6-20R	•	•
15W48BK	20	250	Connector, Black, NEMA 4X/6P	6-20R	•	•
60W48	20	250	Single Receptacle, Yellow, NEMA 4X/6P	6-20R	•	•
60W48DPLX	20	250	Duplex Receptacle, Yellow, NEMA 4X/6P	6-20R	•	•
14W07	15/10	125/250	Plug, Yellow, NEMA 4X/6P	NON	•	•
15W07	15/10	125/250	Connector, Yellow, NEMA 4X/6P	NON	•	•
60W07	15/10	125/250	Single Receptacle, Yellow, NEMA 4X/6P	NON	•	•

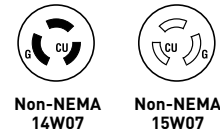
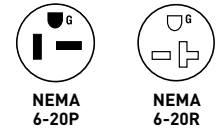
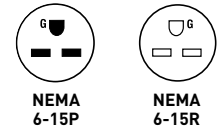
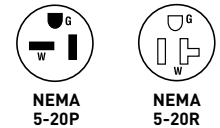
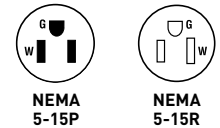

RUBBER & WATERTIGHT DEVICES

Watertight Turnlok® Plugs, Connectors & Receptacles

2 Pole, 3 Wire Grounding 15 & 20A, 125/250, 250 & 277V

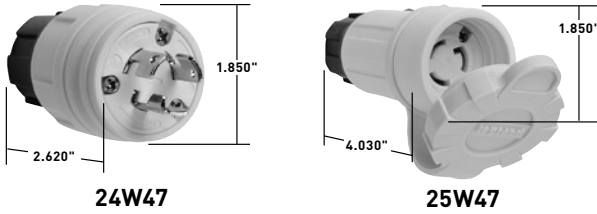

Features

- Thermoplastic elastomer body construction stands up to impacts, oils, chemicals, heat, and weather.
- Large ribs on body for a superior grip when mating.
- Quick-drive assembly screws allow for fast installation, saving time and money.
- NEMA 4, 4X, 6, 6P Watertight. IP65, 66, 67. Rated watertight for 1,500 psi highpressure hose-down.
- Terminal screws backed-out, ready-to-wire, saving time and money.
- Multipoint sealing system between plug and connector ensures protection from water and contaminants.
- Valox compression-type cord grip provides watertight seal and great pull out strength.
- Nickel-plated blades and contacts for long-lasting, superior corrosion resistance.

CATALOG NUMBER	RATING		DESCRIPTION	NEMA CONFIG. NO.	3rd PARTY COMPLIANCE	
	A.	V.			UL UL498	CSA C22.2 No. 42M
WATERTIGHT PLUGS, CONNECTORS & RECEPTACLES						
24W47	15	125	Plug, Yellow, NEMA 4X/6P	L5-15P	•	•
25W47	15	125	Connector, Yellow, NEMA 4X/6P	L5-15R	•	•
65W47	15	125	Single Receptacle, Yellow, NEMA 4X/6P	L5-15R	•	•
65W47DPLX	15	125	Duplex Receptacle, Yellow, NEMA 4X/6P	L5-15R	•	•
26W47	20	125	Plug, Yellow, NEMA 4X/6P	L5-20P	•	•
26W47GCM	20	125	Plug, Yellow, NEMA 4X/6P, Grd Continuity Monitoring	L5-20P	•	•
27W47	20	125	Connector, Yellow, NEMA 4X/6P	L5-20R	•	•
27W47GCM	20	125	Connector, Yellow, NEMA 4X/6P, Grd Continuity Monitoring	L5-20R	•	•
67W47	20	125	Single Receptacle, Yellow, NEMA 4X/6P	L5-20R	•	•
28W47	30	125	Plug, Yellow, NEMA 4X/6P	L5-30P	•	•
29W47	30	125	Connector, Yellow, NEMA 4X/6P	L5-30R	•	•
69W47	30	125	Single Receptacle, Yellow, NEMA 4X/6P	L5-30R	•	•
24W49	15	250	Plug, Yellow, NEMA 4X/6P	L6-15P	•	•
25W49	15	250	Connector, Yellow, NEMA 4X/6P	L6-15R	•	•
65W49	15	250	Single Receptacle, Yellow, NEMA 4X/6P	L6-15R	•	•
65W49DPLX	15	250	Duplex Receptacle, Yellow, NEMA 4X/6P	L6-15R	•	•
26W48	20	250	Plug, Yellow, NEMA 4X/6P	L6-20P	•	•
27W48	20	250	Connector, Yellow, NEMA 4X/6P	L6-20R	•	•
67W48	20	250	Single Receptacle, Yellow, NEMA 4X/6P	L6-20R	•	•
28W48	30	250	Plug, Yellow, NEMA 4X/6P	L6-30P	•	•
29W48	30	250	Connector, Yellow, NEMA 4X/6P	L6-30R	•	•
69W48	30	250	Single Receptacle, Yellow, NEMA 4X/6P	L6-30R	•	•
24W34	15	277	Plug, Yellow, NEMA 4X/6P	L7-15P	•	•
25W34	15	277	Connector, Yellow, NEMA 4X/6P	L7-15R	•	•
65W34	15	277	Single Receptacle, Yellow, NEMA 4X/6P	L7-15R	•	•
65W34DPLX	15	277	Duplex Receptacle, Yellow, NEMA 4X/6P	L7-15R	•	•
26W49	20	277	Plug, Yellow, NEMA 4X/6P	L7-20P	•	•
27W49	20	277	Connector, Yellow, NEMA 4X/6P	L7-20R	•	•
67W49	20	277	Single Receptacle, Yellow, NEMA 4X/6P	L7-20R	•	•
28W49	30	277	Plug, Yellow, NEMA 4X/6P	L7-30P	•	•
29W49	30	277	Connector, Yellow, NEMA 4X/6P	L7-30R	•	•
69W49	30	277	Single Receptacle, Yellow, NEMA 4X/6P	L7-30R	•	•

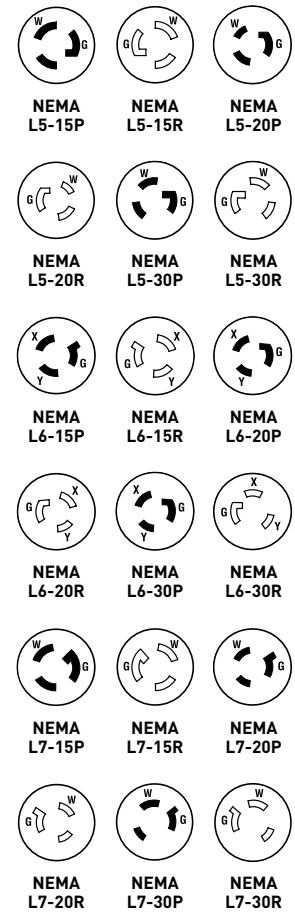

RUBBER & WATERTIGHT DEVICES

Watertight Turnlok® Plugs, Connectors & Receptacles 3 Pole, 4 Wire Grounding 20 & 30A, 125/250, 3ø250, 3ø480, 3ø600V; 3 Pole, 3 Wire 20A, 125/250V

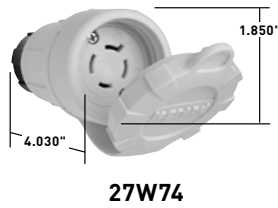

CATALOG NUMBER	RATING		DESCRIPTION	NEMA CONFIG. NO.	3rd PARTY COMPLIANCE	
	A.	V.			UL498	C22.2 No. 42M
WATERTIGHT PLUGS, CONNECTORS & RECEPTACLES						
26W74	20	125/250	Plug, Yellow, NEMA 4X/6P	L14-20P	•	•
27W74	20	125/250	Connector, Yellow, NEMA 4X/6P	L14-20R	•	•
67W74	20	125/250	Single Receptacle, Yellow, NEMA 4X/6P	L14-20R	•	•
28W74	30	125/250	Plug, Yellow, NEMA 4X/6P	L14-30P	•	•
29W74	30	125/250	Connector, Yellow, NEMA 4X/6P	L14-30R	•	•
69W74	30	125/250	Single Receptacle, Yellow, NEMA 4X/6P	L14-30R	•	•
26W75	20	3ø250	Plug, Yellow, NEMA 4X/6P	L15-20P	•	•
27W75	20	3ø250	Connector, Yellow, NEMA 4X/6P	L15-20R	•	•
67W75	20	3ø250	Single Receptacle, Yellow, NEMA 4X/6P	L15-20R	•	•
28W75	30	3ø250	Plug, Yellow, NEMA 4X/6P	L15-30P	•	•
29W75	30	3ø250	Connector, Yellow, NEMA 4X/6P	L15-30R	•	•
69W75	30	3ø250	Single Receptacle, Yellow, NEMA 4X/6P	L15-30R	•	•
26W76	20	3ø480	Plug, Yellow, NEMA 4X/6P	L16-20P	•	•
27W76	20	3ø480	Connector, Yellow, NEMA 4X/6P	L16-20R	•	•
67W76	20	3ø480	Single Receptacle, Yellow, NEMA 4X/6P	L16-20R	•	•
28W76	30	3ø480	Plug, Yellow, NEMA 4X/6P	L16-30P	•	•
29W76	30	3ø480	Connector, Yellow, NEMA 4X/6P	L16-30R	•	•
69W76	30	3ø480	Single Receptacle, Yellow, NEMA 4X/6P	L16-30R	•	•
28W77	30	3øY 600	Plug, Yellow, NEMA 4X/6P	L17-30P	•	•
29W77	30	3øY 600	Connector, Yellow, NEMA 4X/6P	L17-30R	•	•
69W77	30	3øY 600	Single Receptacle, Yellow, NEMA 4X/6P	L17-30R	•	•
26W08	20	125/250	Plug, Yellow, NEMA 4X/6P	NON	•	•
27W08	20	125/250	Connector, Yellow, NEMA 4X/6P	NON	•	•
67W08	20	125/250	Single Receptacle, Yellow, NEMA 4X/6P	NON	•	•
28W08	30	125/250	Plug, Yellow, NEMA 4X/6P	NON	•	•
29W08	30	125/250	Connector, Yellow, NEMA 4X/6P	NON	•	•
69W08	30	125/250	Single Receptacle, Yellow, NEMA 4X/6P	NON	•	•
28W09	30	3øY 120/208	Plug, Yellow, NEMA 4X/6P	NON	•	•
29W09	30	3øY 120/208	Connector, Yellow, NEMA 4X/6P	NON	•	•
69W09	30	3øY 120/208	Single Receptacle, Yellow, NEMA 4X/6P	NON	•	•

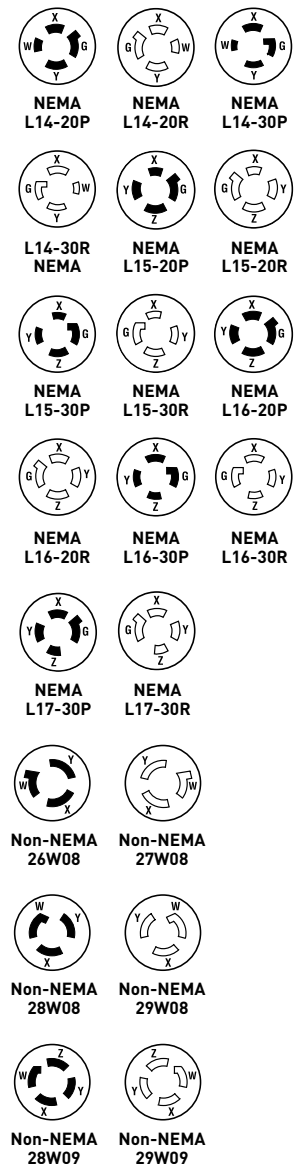

RUBBER & WATERTIGHT DEVICES

RUBBER & WATERTIGHT DEVICES

Watertight Back Boxes

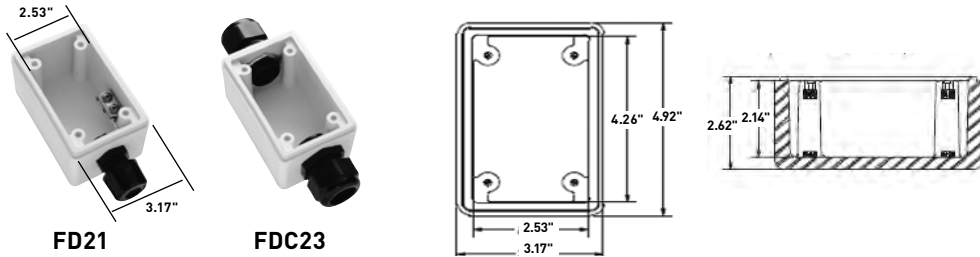

Features

- Back Box available in 1/2", 3/4" and 1" NPT openings.
- Back Box available in both deep and feed-through configurations.
- Thermoplastic elastomer construction withstands chemicals and impacts.

CATALOG NUMBER	DESCRIPTION
WATERTIGHT BACK BOXES	
FD11	Yellow Back Box, Deep, 1/2" Single Receptacle
FD12	Yellow Back Box, Deep, 3/4" Single Receptacle
FD13	Yellow Back Box, Deep, 1" Single Receptacle
FD12BK	Black Back Box, Deep, 3/4" Single Receptacle
FD21	Yellow Back Box, Deep, 1/2" Duplex Receptacle
FD22	Yellow Back Box, Deep, 3/4" Duplex Receptacle
FD23	Yellow Back Box, Deep, 1" Duplex Receptacle
FD22BK	Black Back Box, Deep, 3/4" Duplex Receptacle
FDC21	Yellow Back Box, Deep, 1/2" Feed-Through Duplex Receptacle
FDC22	Yellow Back Box, Deep, 3/4" Feed-Through Duplex Receptacle
FDC23	Yellow Back Box, Deep, 1" Feed-Through Duplex Receptacle
FDC22BK	Black Back Box, Deep, 3/4" Feed-Through Duplex Receptacle
PSWALLKIT	Yellow Back Box, Wall Mount Kit
F022	Yellow Back Box, Deep, Open, 3/4" Duplex Receptacle
PSGRIPKIT1	1/2" Bushing Kit .37 - .61 Range
PSGRIPKIT2	3/4" Bushing Kit .45 - .70 Range
PSGRIPKIT3	1" Bushing Kit .59 - 1.00 Range

CATALOG NUMBER	DESCRIPTION
WATERTIGHT ACCESSORIES	
PS15WT	Female Watertight Cap 15/20A Straight Blade & 15A Locking Devices
PS27WT	Female Watertight Cap 20A Locking Devices
PS29WT	Female Watertight Cap 30A Locking Devices
PS14WT	Male Watertight Cap 15/20A Straight Blade & 15A Locking Devices
6500	Cover for 15/20A Straight Blade & Turnlok Watertight Receptacles
6700	Cover for 20A Turnlok Watertight Receptacles
6800	Cover for 30A Turnlok Watertight Receptacles



PS14WT



6500/6700/6800

RUBBER & WATERTIGHT DEVICES

Industrial Grade Portable Outlet Boxes & Covers

Features & Benefits

- Available in both clamp and cord grip styles, covering a wide range of cable diameters.
- Molded of thermoplastic elastomer (TPE), these non-conductive boxes are crushproof, and resistant to jobsite abuse and electrical shock.
- Available in both pendant and feed-through types.
- Heavy-duty stainless steel spring-loaded fliplids provide NEMA Type 3R protection.
- A wide array of cover options are available.

CATALOG NUMBER	DESCRIPTION
PORTABLE OUTLET BOXES	
3050	Yellow Rubber Box, 1 Clamp, Standard Depth
3050BK	Black Rubber Box, 1 Clamp, Standard Depth
3059	Yellow Rubber Box, 1 Grip, Standard Depth
3059BK	Black Rubber Box, 1 Grip, Standard Depth
3059F	Yellow Rubber Box, 2 Grips, Standard Depth
3059FBK	Black Rubber Box, 2 Grips, Standard Depth
3090	Yellow Rubber Box, 1 Clamp, Deep Depth
3099	Yellow Rubber Box, 1 Grip, Deep Depth
3099BK	Black Rubber Box, 1 Grip, Deep Depth
3099F	Yellow Rubber Box, 2 Grips, Deep Depth
3099FBK	Black Rubber Box, 2 Grips, Deep Depth
3200	2G Yellow Rubber Box, 1 - 3/4 KO, Deep
3200BK	2G Black Rubber Box, 1 - 3/4 KO, Deep
3300	2G Yellow Rubber Box, 2 - 3/4 KO, Deep
3300BK	2G Black Rubber Box, 2 - 3/4 KO, Deep

CATALOG NUMBER	DESCRIPTION
PORTABLE OUTLET BOXES	
3051BK	1G Black Duplex Cover Plate
3056BK	1G Black Flip Lid Dplx Cover Plate
3052BK	1G Black 1.39 Dia Rec Cover Plate
3057BK	1G Black Flip Lid 1.39 Dia Cover Plate
3055BK	1G Black 1.56 Dia Rec Cover Plate
3058BK	1G Black Flip Lid 1.56 Dia Cover Plate
3054BK	1G Black Blank Cover Plate
3060BK	1G Black GFCI Cover Plate
3061BK	1G Black Flip Lid GFCI Cover Plate
3260BK	2G Black 2-Duplex Cover Plate
3260WBK	2G Black Flip Lid 2-Dplx Cover Plate
3261BK	2G Black 1-1.56, 1-Blank Cover Plate
3261WBK	2G Black Flip Lid 1.56, Blank Cover Plate
3263BK	2G Black 2-1.56 Dia Cover Plate
3263WBK	2G BLCK Flip Lid 2-1.56 Dia Cover Plate
3265BK	2G Black Blank Cover Plate
3267BK	2G Black 1-GFCI, 1 Duplex Cover Plate
3267WBK	2G Black FlipLid 1 GFCI, 1 Duplex Cover Plate
3241BK	2G Black 1-GFCI, 1 Blank Cover Plate
3241WBK	2G Black FlipLid 1 GFCI, 1 Blank Cover Plate
3251BK	2G Black 2-GFCI Cover Plate
3251WBK	2G Black Flip Lid 2-GFCI Cover Plate
3262BK	2G Black 1-1.56 Dia, 1 Duplex Cover Plate
3262WBK	2G Black Flip Lid 1-1.56, 1-Duplex Cover

Single Gang Outlet Boxes (Clamp Style)

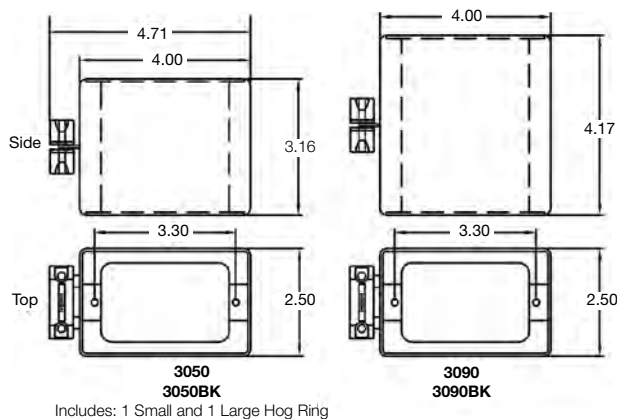

RUBBER & WATERTIGHT DEVICES

Industrial Grade Portable Outlet Boxes & Covers

Single Gang Outlet Boxes (Cord Grip Style)

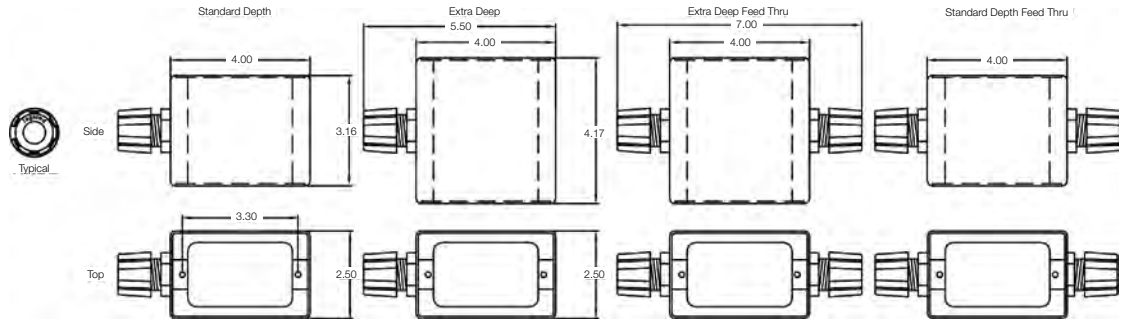

Single Gang Covers

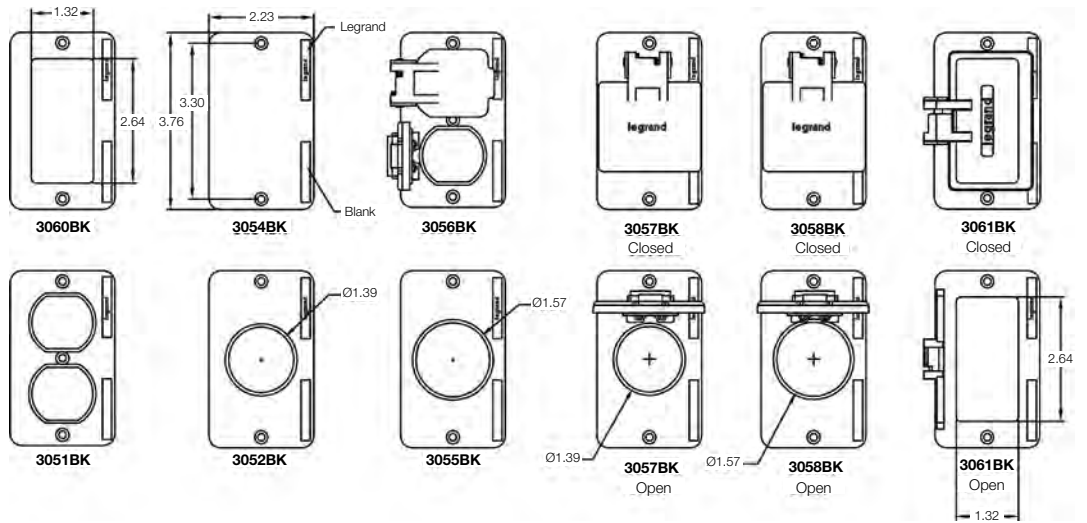

Double Gang Covers

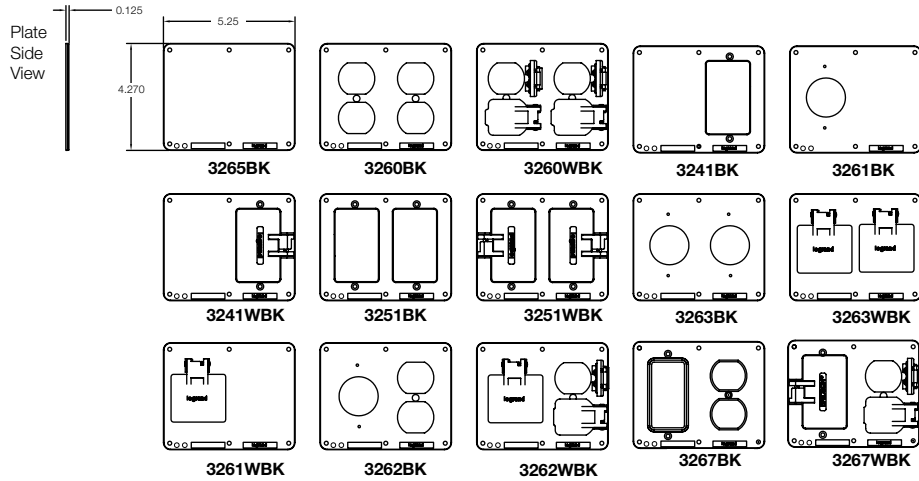

Double Gang Outlet Boxes

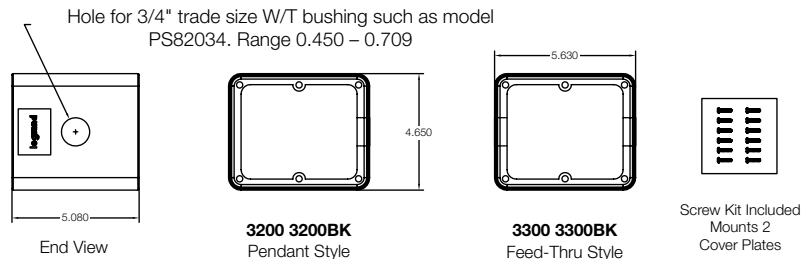

RUBBER & WATERTIGHT DEVICES

RUBBER & WATERTIGHT DEVICES

P&S® SteriGuard™ Antimicrobial Wiring Devices & Accessories

15W47AM

Straight Blade and Turnlok® Plugs & Connectors

SteriGuard™ Antimicrobial Wiring Solutions provide excellent protection against the growth of microbes on all surfaces. Independent testing proves the ability of these devices to inhibit the growth of *Escherichia coli*, Gram (-) and *Staphylococcus aureus*, Gram (+) providing long-lasting benefits to manufacturers beyond conventional cleaning methods.

Rated watertight for 1,500 psi high-pressure hosedown, these plugs and connectors feature multiple seals to ensure protection against the environment. SteriGuard provides a cost-effective way to add additional safety precautions and unequalled assurance that every feasible step has been taken in the interest of consumer protection.

- **NSF Certified.**
- **Antimicrobial additive additives** embedded in Polymer inhibits growth of bacteria, molds, mildews, and fungi.
- **Antimicrobial additive resistant to scuffing and cleaning.**
- **Independently tested and certified to JIS Z2801.**
- **Thermoplastic elastomer body construction** stands up to impacts, oils, heat, and weather.
- **Large ribs on body** for a superior grip when mating.
- **Quick-drive assembly screws** allow fast installation, saving time and money.
- **NEMA 4, 4X, 6, 6P Watertight. IP65, 66, 67.** Rated watertight for 1,500 psi high pressure hose-down.
- **Terminal screws backed-out, ready-to-wire,** saving time and money during installation.
- **Multipoint sealing system between plug and connector** ensures protection from water and contaminants.
- **Valox compression-type cord grip** provides watertight seal and great pull out strength.
- **Nickel-plated blades and contacts** for long-lasting, superior corrosion resistance.

Antimicrobial Reductions

- **Escherichia (E. Coli):** Log Reduction > 4.8, reduces surface bacteria by > 99.99%
- **Staphylococcus (Staph), MRSA:** Log Reduction > 3.9, reduces surface bacteria by > 99.98%
- **Listeria monocytogenes:** Log Reduction > 4.3, reduces surface bacteria by > 99.99%
- **Salmonella:** Log Reduction > 3.6, reduces surface bacteria by > 99.97%

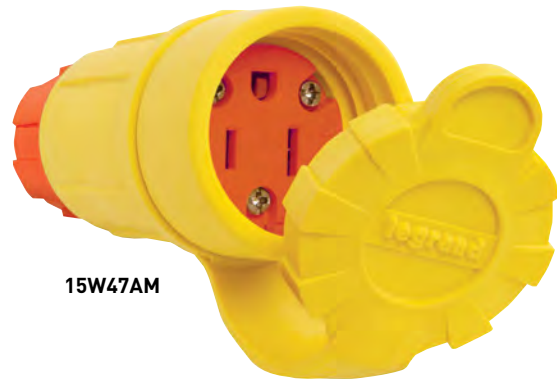

15W47AM



14W48AM



RUBBER & WATERTIGHT DEVICES

P&S® SteriGuard™ Antimicrobial Wiring Devices & Accessories

CATALOG NUMBER	RATING		DESCRIPTION	NEMA CONFIG. NO.
	A.	V.		
STRAIGHT BLADE 2 POLE/3 WIRE				
14W47AM	15	125	Plug	5-15P
15W47AM			Connector	5-15R
14W33AM	20	125	Plug	5-20P
15W33AM			Connector	5-20R
14W49AM	15	250	Plug	6-15P
15W49AM			Connector	6-15R
14W48AM	20	250	Plug	6-20P
15W48AM			Connector	6-20R
TURNLOK® 2 POLE/3 WIRE				
24W47AM	15	125	Plug	L5-15P
25W47AM			Connector	L5-15R
26W47AM	20	125	Plug	L5-20P
27W47AM			Connector	L5-20R
28W47AM	30	125	Plug	L5-30P
29W47AM			Connector	L5-30R
24W49AM	15	250	Plug	L6-15P
25W49AM			Connector	L6-15R
26W48AM	20	250	Plug	L6-20P
27W48AM			Connector	L6-20R
28W48AM	30	250	Plug	L6-30P
29W48AM			Connector	L6-30R
24W34AM	15	277	Plug	L7-15P
25W34AM			Connector	L7-15R
26W49AM	20	277	Plug	L7-20P
27W49AM			Connector	L7-20R
28W49AM	30	277	Plug	L7-30P
29W49AM			Connector	L7-30R
TURNLOK® 3 POLE/4 WIRE				
26W74AM	20	125/250	Plug	L14-20P
27W74AM			Connector	L14-20R
28W74AM	30	125/250	Plug	L14-30P
29W74AM			Connector	L14-30R
26W75AM	20	3Ø250	Plug	L15-20P
27W75AM			Connector	L15-20R
28W75AM	30	3Ø250	Plug	L15-30P
29W75AM			Connector	L15-30R
26W76AM	20	3Ø480	Plug	L16-20P
27W76AM			Connector	L16-20R



SteriGuard Straight Blade Plug



SteriGuard Turnlok Plug

CATALOG NUMBER	RATING		DESCRIPTION	NEMA CONFIG. NO.
	A.	V.		
TURNLOK® 3 POLE/4 WIRE (con't)				
28W76AM	30	3Ø480	Plug	L16-30P
29W76AM			Connector	L16-30R
28W77AM	30	3Ø600	Plug	L17-30P
29W77AM			Connector	L17-30R
TURNLOK® NON-NEMA				
26W08AM	20	125/250	Plug, 3P/3W NG	•
27W08AM			Connector, 3P/3W NG	•
28W08AM	30	125/250	Plug, 3P/3W NG	•
29W08AM			Connector, 3P/3W NG	•
28W09AM	30	3ØY	Plug, 4P/4W NG	•
29W09AM		120/208	Connector, 4P/4W NG	•

CATALOG NUMBER	DESCRIPTION
STERIGUARD ACCESSORIES	
PS15WTAM	Female Watertight Cap 15/20A Straight Blade & 15A Locking Devices
PS27WTAM	Female Watertight Cap 20A Locking Devices
PS29WTAM	Female Watertight Cap 30A Locking Devices
PS14WTAM	Male Watertight Cap 15/20A Straight Blade & 15A Locking Devices

RUBBER & WATERTIGHT DEVICES

P&S® SteriGuard™ Antimicrobial Bulk Portable Cord & Antimicrobial Cord Drops



SteriGuard Bulk Portable Cord

Features & Benefits

- Custom cord drops are engineered to order for desired length specifications and NEMA configurations
- Antimicrobial additives embedded in polymer and inhibit growth of bacteria, molds, mildews, and fungi
 - Escherichia (E.Coli): Log reduction > 4.3, reduces surface bacteria by > 99.99%
 - Staphylococcus (Staph), MRSA: Log reduction > 4.3, reduces surface bacteria by > 99.97%
 - Salmonella: Log reduction > 3.6, reduces surface bacteria by > 99.97%
- RoHS compliant (non-halogenated)
- Antimicrobial additive is resistant to scuffing and cleaning
- Independently tested and certified to JIS Z2801 standards
- Ideal for use in food & beverage preparation, processing, and packaging; agriculture; pharmaceutical; health care; and more

CATALOG NUMBER	DESCRIPTION
P&S® STERIGUARD™ ANTIMICROBIAL BULK PORTABLE CORD	
PS163AM	16/3 SEOW/STOW Antimicrobial cord
PS143AM	14/3 SEOW/STOW Antimicrobial cord
PS123AM	12/3 SEOW/STOW Antimicrobial cord
PS103AM	10/3 SEOW/STOW Antimicrobial cord
PS124AM	12/4 SEOW/STOW Antimicrobial cord
PS104AM	10/4 SEOW/STOW Antimicrobial cord

P&S® SteriGuard™ Antimicrobial Cord Drops

To ensure you get the right product for your application, use the charts and follow the example below to select the right cord size and type, your required length, and the device part number. To place the order contact Customer Service at **800-223-4162** or **customer.support@legrand.us**

PS

Prefix

123

Cord Size and Type

143 = 14/3 SEOW

123 = 12/3 SEOW

124 = 12/4 SEOW

103 = 10/3 SEOW

104 = 10/4 SEOW

Other sizes available upon request.

XX

Select Length
(1 to 99 ft.)

14W47AM

SteriGuard Part No.

Select specific device from the chart. Part number shown above is an example only.

Bulk Cord—UL SEOW, cUL STOW

Cord Drops—Wiring Devices: UL/CSA Listed — Industrial Cord: UL SEOW, cUL STOW



SteriGuard Antimicrobial Cord Drop

RUBBER & WATERTIGHT DEVICES

Product Specifications & Performance

Rubber Dust-Tight Plugs & Connectors

Plugs & Connectors	
Part	Material
Body	Thermoplastic Elastomer
Terminal Chamber	Polycarbonate
Compression Nut	Nylon
Compression Grommet	Thermoplastic Elastomer
Dust Cover	Thermoplastic Elastomer
Plug Blades	Brass
Connector Contacts	Brass
Terminal Clamps	Brass
Terminal Screws Hot	Brass
Terminal Screws Hot/Neutral	Zinc-Plated Brass
Ground Screws	Zinc/Green-Plated Brass, Hex-Head
Assembly Screws	Stainless Steel

Performance	
Electrical	
Dielectric Withstand Voltage	15A = 1600V minimum, 20A & 30A = 2200V minimum
Maximum Working Voltage	15A = 277VAC, 20 & 30A = 600VAC
Current Interrupting	Certified for current interrupting at full-rated current
Temperature Rise	30°C maximum after 50 cycles at 150% rated current
Mechanical	
Cord Accommodations	Round portable service cords of diameters in accordance with the device rating as defined in UL62
Terminal Identification	15A = Green = Ground, White = Neutral, Brass = Hot 20A & 30A = "GR" and Green color = Ground, "WH" and White color = Neutral, "X", "Y", "Z" = Hot
Terminal Accommodation	15A = #18 AWG min. - #10 AWG max. 20A = #18 AWG min. - #8 AWG max. 30A = #18 AWG min. - #6 AWG max.
Product Identification	Amperage, Voltage, 3rd Party Compliance, NEMA Configuration hot stamped onto device
Environmental	
Flammability	UL94 V2
Operating Temperature	Maximum continuous +75°C, minimum -40°C without impact

Wateright Plugs & Connectors

Plugs & Connectors	
Part	Material
Body/Contact Carrier	PBT Thermoplastic, Yellow
Terminal Retainer	Polycarbonate, Clear
Housing	Thermoplastic Elastomer, Yellow
Housing Insert	Polypropylene, Natural
Strain Relief Nut	PBT Thermoplastic, Black
Grommet	Thermoplastic Elastomer, Various Colors
Ferrule	Polypropylene, Natural
Blades/Contacts	Brass, Nickel
Terminal Screws	Steel, Chromate
Terminal Screw Size	#8-32
Body Holding Screws	Stainless Steel
Drive Screws	Steel, Chromate

Performance	
Electrical	
Dielectric Withstand Voltage	
Connectors:	2000V AC if rated 300V or less 3000V AC if rated above 300V
Plugs:	2500V AC if rated 300V or less 3500V AC if rated above 300V
Maximum Working Voltage	As marked
Current Interrupting	Rated for current interruption per UL498
Temperature Rise	30°C maximum per UL498 at rated current
Mechanical	
Cord & Terminal Accommodations:	
Plugs & Connectors	
15A & 20A Straight Blade and 15A locking	Type S, S0, ST, SJ, SJO, SJT, 18/3 to 12/3, .300 min. to .625 in. max [7.6 to 15.9mm] dia.
20A & 30A 3-wire locking	12/3 SJ, 14/3 S to 10/3 S, [.475" to .720"] [12.1mm to 19.2mm]
20A 4-wire locking	14/4 S to 10/4 S, [.560" to .775"] [14.2mm to 19.9mm]
30A 4-wire locking	12/4 S to 8/4 S, 6/4 MSHA [.640" to .930"] [16.3mm to 23.6mm]
All 15A & 20A straight blade	18 AWG to 12 AWG
20A locking & 30A 3-wire	14 AWG to 10 AWG
30A 4-wire	12 AWG to 6 AWG
Environmental	
Moisture Resistance	NEMA 4, 4X, 12, 6, 6P (Plug & Connector only)
Flammability	UL94V0 (boxes & wiring device interiors)
Operating Temperature	-40°C (without impact) to +60°C continuous
UV resistance	All exposed materials are UV stabilized

RUBBER & WATERTIGHT DEVICES

Product Specifications & Performance

SteriGuard™ Watertight Plugs & Connectors

Plugs & Connectors

Part	Material
Body/Contact Carrier	PBT Thermoplastic, Yellow
Terminal Retainer	Polycarbonate, Clear
Housing	Thermoplastic Elastomer, Yellow
Housing Insert	Polypropylene, Natural
Strain Relief Nut	PBT Thermoplastic, Black
Grommet Colors	Thermoplastic Elastomer, Various
Ferrule	Polypropylene, Natural
Blades/Contacts	Brass, Nickel
Terminal Screws	Steel, Chromate
Terminal Screw Size	#8-32
Body Holding Screws	Stainless Steel
Drive Screws	Steel, Chromate

Performance

Electrical

Dielectric Withstand Voltage	
Connectors:	2000V AC if rated 300V or less 3000V AC if rated above 300V
Plugs:	2500V AC if rated 300V or less 3500V AC if rated above 300V
Maximum Working Voltage	As marked
Current Interrupting	Rated for current interruption per UL498
Temperature Rise	30°C maximum per UL498 at rated current

Mechanical

Cord & Terminal Accommodations:

Plugs & Connectors	
15A & 20A Straight Blade and 15A locking	Type S, SO, ST, SJ, SJO, SJT, 18/3 to 12/3, .300 min. to .625 in. max [7.6 to 15.9mm] dia.
20A & 30A 3-wire locking	12/3 SJ, 14/3 S to 10/3 S, [.475" to .720"] [12.1mm to 19.2mm]
20A 4-wire locking	14/4 S to 10/4 S, [.560" to .775"] [14.2mm to 19.9mm]
30A 4-wire locking	12/4 S to 8/4 S, 6/4 MSHA [.640" to .930"] [16.3mm to 23.6mm]
All 15A & 20A straight blade	18 AWG to 12 AWG
20A locking & 30A 3-wire	14 AWG to 10 AWG
30A 4-wire	12 AWG to 6 AWG

Environmental

Moisture Resistance	NEMA 4, 4X, 12, 6, 6P/IP65, 66, 67 (Plug & Connector only)
Flammability	UL94V0 (boxes & wiring device interiors)
Operating Temperature	-40°C (without impact) to +60°C continuous
UV resistance	All exposed materials are UV stabilized

SWITCH DISCONNECTS & MANUAL MOTOR CONTROLLERS



P&S Safety Switches and Manual Motor Controllers provide maximum durability and minimum downtime in difficult industrial environments. P&S Fusible Safety Switches were the first with visible indication of a blown fuse, allowing for quick identification and replacement. All safety switches are constructed to provide maximum protection against water, dirt, heat and vibration – and just about anything else you can throw at it. See how P&S switches and controllers can help your plant or facility.

Featured Products	 MANUAL MOTOR CONTROLLERS M-2	 NON-FUSIBLE SAFETY SWITCHES M-12	 STAINLESS STEEL SAFETY SWITCH M-17
--------------------------	---	--	---

Manual Controllers	M-2	Stainless Steel Safety Switches	M-17
Non-Fusible Safety Switches	M-7	Slope Top Stainless Steel Safety Switches	M-20
Fusible Safety Switches	M-12	Non-Metallic Safety Switches	M-23

SWITCH DISCONNECTS & MANUAL MOTOR CONTROLLERS

Manual Controllers

7803MD

Manual Controller

- A. Heavy-duty, zinc-plated strap** resists corrosion; two rolled-brass rivets secure the strap to the housing to avoid field tampering.
- B. Two-point contact arm design** reduces overall unit size; provides more enclosure space.
- C. Thermoplastic housing** resists tracking; withstands impacts.
- D. Two oversized silver alloy contacts** withstand years of use; improve heat dissipation by distributing arc energy.
- E. One-piece contact carrier** constructed of glass-reinforced thermoplastic ensures long-lasting "make and break" performance.
- F. Exclusive, ready-to-wire external screw-pressure-plate back and side wire** capability for easy installation with solid or stranded wire.
- G. Oversized #10 terminal screws** increase contact with wire and increase torque limit. Angled screw heads for easier access.

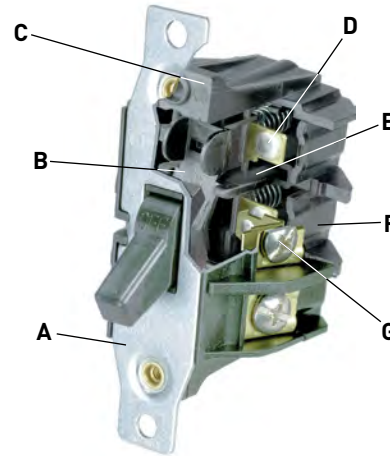

NEMA Type Enclosures

NEMA Type 1 Enclosures – Intended for indoor use primarily to provide a degree of protection against limited amounts of falling dirt in locations where unusual service conditions do not exist.

NEMA Type 7 Enclosures – Intended for indoor use in locations classified as Class 1, Group A, B, C, or D, as defined in the National Electrical Code. They shall be capable of withstanding the pressures resulting from an internal explosion of specified gases, and contain such an explosion sufficient that an explosive gas-air mixture existing in the atmosphere surrounding the enclosure will not be ignited. Enclosed heat generating devices shall not cause external surfaces to reach temperatures capable of igniting explosive gas-air mixtures in the surrounding atmosphere. Enclosures shall meet explosion, hydrostatic, and temperature design tests.

NEMA Type 3R Enclosures – Intended for outdoor use primarily to provide a degree of protection against rain and sleet; and to be undamaged by the formation of ice on the enclosure. They are not intended to provide protection against conditions such as internal condensation, or internal icing.

NEMA Type 9 Enclosures – Intended for indoor use in locations classified as Class II, Groups E, F, or G, as defined in the National Electrical Code. They shall be capable of preventing the entrance of dust. Enclosed heat generating devices shall not cause external surfaces to reach temperatures capable of igniting or discoloring dust on the enclosure or igniting dust-air mixtures in the surrounding atmosphere. Enclosures shall meet dust penetration and temperature design tests, and aging of gaskets (if used).

SWITCH DISCONNECTS & MANUAL MOTOR CONTROLLERS

Manual Controllers 30A, 1Ø & 3Ø

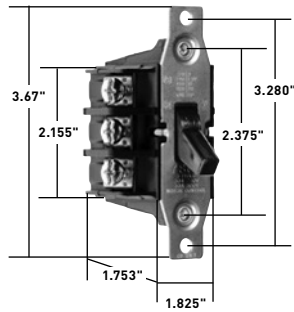

7802MD, 7803MD



7812PMD, 7813PMD

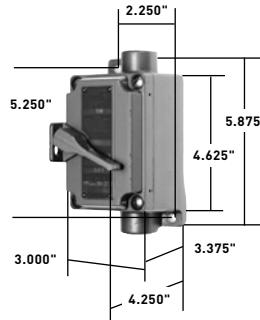

7812EX, 7813EX

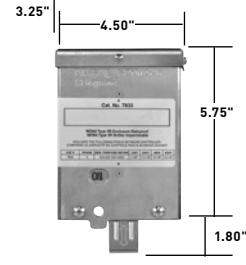

7832MD, 7833MD

Features – 7802MD & 7803MD

- High horsepower rating of 20HP
- Compact design.
- Gull-wing shaped brass terminal pressure clamps.
- Constructed of glass-reinforced thermoplastic.
- Two-point contact arms.
- One-piece contact carrier.
- UL508 and cULus Listing of individual device and assembled device within enclosure.
- Heavy-duty zinc-plated steel strap.
- Two brass rivets secure strap to housing.
- External screw-pressure-plate back and side wire terminal screws unstaked for use with ring terminals.
- Oversized silver alloy contacts.
- 2-3/4" hubs (7812EX and 7813EX).
- 2-1/2" knockouts on back and 2-1/2"-3/4" knockouts on top and bottom (7812PMD, 7813PMD, 7806P).
- 2-1/2" knockouts on bottom and back (7832MD and 7833MD).
- Slotted opening on enclosures allows for lock-out, tag-out functionality.

CATALOG NUMBER	DESCRIPTION	RATING			
		A.	V.	HP	VAC
DOUBLE POLE, SINGLE PHASE					
7802MD	Double Pole, Single Phase AC Manual Motor Controller (No overload protection), See Footnote 1	General Use 30	600 max.	2 3 7.5 10	120 240 480 600
7812PMD	7802MD in a NEMA 1 Enclosure, See Footnote 1	Same as 7802MD			
7812EX	7802MD in a NEMA 7 and 9 Enclosure for Hazardous Locations Class I - Groups C, D; Class II - Groups E, F, G	Same as 7802MD			
7832MD	7802MD in a NEMA 3R Enclosure, See Footnote 1	Same as 7802MD			
THREE POLE, THREE PHASE					
7803MD	Three Pole, Three Phase AC Manual Motor Controller (No overload protection), See Footnote 1	General Use 30	600 max.	3 7.5 10 20	120 240 480 600
7813PMD	7803MD in a NEMA 1 Enclosure, See Footnote 1	Same as 7803MD			
7813EX	7803MD in a NEMA 7 and 9 Enclosure for Hazardous Locations Class I - Groups C, D; Class II - Groups E, F, G	Same as 7803MD			
7833MD	7803MD in a NEMA 3R Enclosure, See Footnote 1	Same as 7803MD			
7806P	NEMA 1 Black Nylon Enclosure with 1/2" and 3/4" knockouts at each end.				
7801P	Handle Locking Guard has opening for padlock to secure control in either ON or OFF position.				
7830	NEMA 3R Aluminum Enclosure.				

All Industrial Control Equipment is suitable for use in a circuit capable of deliverable not more than 5,000 rms amperes at 600VAC maximum or equivalent.

Footnote 1. Suitable as Motor Disconnect – 10KA @ 600VAC, 30A max. Class J Fuse.

SWITCH DISCONNECTS & MANUAL MOTOR CONTROLLERS

Manual Controllers 40A, 1Ø & 3Ø

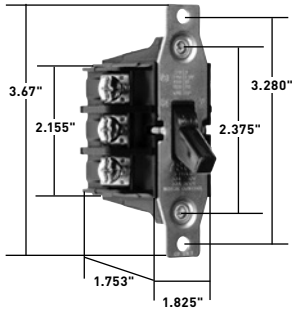

7842MD, 7843MD

Features – 7842MD & 7843MD

- High horsepower rating of 20HP
- Compact design.
- Gull-wing shaped brass terminal pressure clamps.
- Constructed of glass-reinforced thermoplastic.
- Two-point contact arms.
- One-piece contact carrier.
- Heavy-duty yellow chromate plated steel strap.
- Two brass rivets secure strap to housing.
- External screw-pressure-plate back and side wire terminal screws unstaked for use with ring terminals.
- Oversized silver alloy contacts.
- UL508 and cULus Listing of individual device and assembled device within enclosure.

CATALOG NUMBER	DESCRIPTION	RATING			
		A.	VAC	HP	VAC
DOUBLE POLE, SINGLE PHASE					
7842MD	Double Pole, Single Phase AC Manual Motor Controller (No overload protection), See Footnote 2	40	600 max.	2 5 10 15	120 240 480 600
THREE POLE, THREE PHASE					
7843MD	Three Pole, Three Phase AC Manual Motor Controller (No overload protection), See Footnote 2	40	600 max.	2 7.5 15 20	120 240 480 600

All Industrial Control Equipment is suitable for use in a circuit capable of deliverable not more than 5,000 rms amperes at 600VAC maximum or equivalent.

Footnote 2. Suitable as Motor Disconnect – 10KA @ 600VAC, 60A max. Class J Fuse or 100A max. Ferraz Shawmut HSJ Fuse.

SWITCH DISCONNECTS & MANUAL MOTOR CONTROLLERS

CATALOG NO.	PHASE	POLE
7802MD or 7842MD	1	2
7803MD or 7843MD	3	3

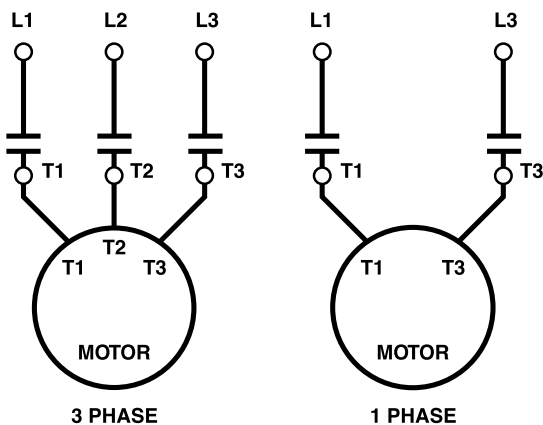

RATINGS

RESISTANCE				
7802MD / 7803MD		30 AMP	600 VAC MAX.	
7842MD / 7843MD		40 AMP	600 VAC MAX.	
MANUAL MOTOR CONTROLLER				
VAC	30A		40A	
	1 PHASE HP	3 PHASE HP	1 PHASE HP	3 PHASE HP
120	2	3	2	3
240	3	7.5	5	7.5
480	7.5	10	10	15
600	10	20	15	20

USE 60 / 75°C WIRING
TORQUE TERMINAL SCREWS
TO 16 IN. LBS.



NO ALUMINUM

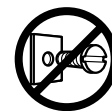

DO NOT
REMOVE SCREWS
FROM 30A DEVICES

SWITCH DISCONNECTS & MANUAL MOTOR CONTROLLERS

Manual Controllers 60A NEMA 3R Manual Controller 20 & 30A 1Ø



7863R

Features

- High horsepower rating, up to 3 HP for heavy duty applications.
- Compact design provides ease of installation.
- Box lug terminals.
- Single piece moveable and stationary contact arms with oversized silver cadmium buttons provides excellent continuity and long life.
- Made in USA.
- Wire pockets and thick wall arc barriers.
- Cold-rolled steel NEMA 3R enclosure with polyester urethane finish conforms to OSHA lockout requirements.
- Type 3R enclosure has 2-1/2", 3/4" and 1" concentric knockouts on bottom.
- Accepts #4 AWG.
- cULus listed.
- Slotted opening on enclosure allows for lock-out, tag-out functionality

CATALOG NUMBER	DESCRIPTION	RATING			
		A.	VAC	HP	VAC
DOUBLE POLE MANUAL MOTOR CONTROLLER					
7862R	Double Pole AC Manual Motor Controller in a NEMA 3R Enclosure	60	600 max.	3 5 15 15	120 240 480 600
7862	Double Pole AC Manual Motor Controller	60	600 max.	Same as 7862R	
THREE POLE MANUAL MOTOR CONTROLLER					
7863R	Three Pole AC Manual Motor Controller in a NEMA 3R Enclosure	60	600 max.	5 10 20 30	120 240 480 600
7863	Three Pole AC Manual Motor Controller	60	600 max.	Same as 7863R	
NEMA 3R ENCLOSURE					
7860	NEMA 3R Enclosure for 7862 & 7863				

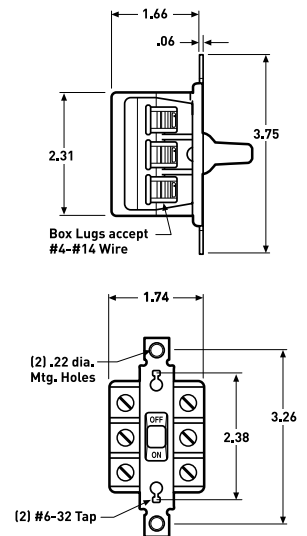

Horsepower Rated Switches

Features

- Oversize silver contacts for long life and better heat dissipation.
- Single phase switches are side wired with #14 AWG - #10 AWG copper or copper-clad conductors.
- Shallow design for ease of installation.
- 2-3/4" hubs (HP30EX).

CATALOG NUMBER	DESCRIPTION	RATING			
		A.	VAC	HP	VAC
DOUBLE POLE, SINGLE PHASE					
PS20AC2HP	Double Pole, Single Phase AC Manual Motor Starting Switch (No overload protection)	20	120/277	1 2	120 240
PS30AC2HP	Double Pole, Single Phase AC Manual Motor Starting Switch (No overload protection)	30	120/277	1 2	120 240
HP30EX	PS30AC2HP in a NEMA 7 & 9 Enclosure for Hazardous Locations Class I - Groups C, D; Class II - Groups E, F, G	Same as PS30AC2HP			

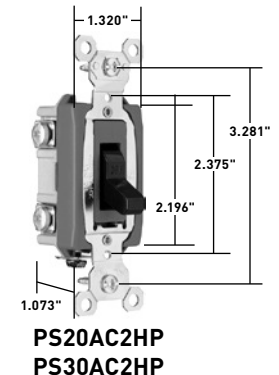

SWITCH DISCONNECTS & MANUAL MOTOR CONTROLLERS

SWITCH DISCONNECTS & MANUAL MOTOR CONTROLLERS

Manual Controllers 15, 20 & 30A, 120/277VAC – Maintained Contact
15, 20 & 30A, 120/277VAC – Momentary Contact

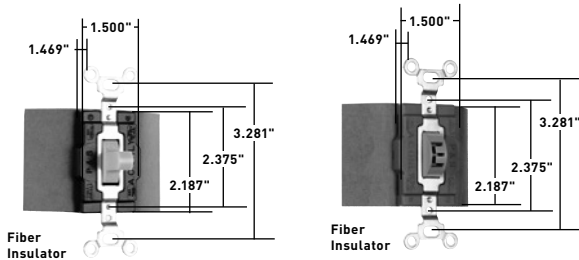

Maintained and Momentary Contact

Locking

Applications

For ON-OFF control of motors on small machine tools, pumps, fans and air conditioning equipment that require heavy-duty AC Double Throw Center OFF controls.

Features

- Oversized silver alloy contacts for long life and better heat dissipation.
- Side wired terminals accept #14 AWG – #10 AWG copper or copper-clad conductors.
- Fiber terminal insulation barriers standard.
- Can be mounted in standard device boxes or in NEMA 1 sheet steel enclosures.
- Bodies, covers and toggles molded of durable nylon.
- Single Pole-Double Throw and Double Pole-Double Throw.
- Locking Switches supplied with one 1498 NT key.
- Normally open.

CATALOG NUMBER		RATING		
S.P.D.T.	D.P.D.T.	A.	VAC	COLOR
MAINTAINED CONTACT THREE POSITION – TWO CIRCUIT, CENTER OFF				
1221I	1222I	15	120/277	Ivory
1221W	1222W	15	120/277	White
1221	1222	15	120/277	Brown
1221LA		15	120/277	Light Almond
1221L	1222L	15	120/277	Locking
1225I	1226I	20	120/277	Ivory
1225W	1226W	20	120/277	White
1225	1226	20	120/277	Brown
1225GRY		20	120/277	Gray
1225LA		20	120/277	Light Almond
1225L	1226L	20	120/277	Locking
1227I	1228I	30	120/277	Ivory
1227	1228	30	120/277	Brown
MAINTAINED CONTACT EITHER DIRECTION TWO POSITION, NO CENTER OFF				
1275	1276	30	120/277	Brown
MOMENTARY CONTACT EITHER DIRECTION THREE POSITION, CENTER OFF				
1250I		15	120/277	Ivory
1250W		15	120/277	White
1250		15	120/277	Brown
1250GRY		15	120/277	Gray
1250RED		15	120/277	Red
1250L		15	120/277	Locking
1251I		20	120/277	Ivory
1251W		20	120/277	White
1251		20	120/277	Brown
1251GRY		20	120/277	Gray
1251RED		20	120/277	Red
1251LA		20	120/277	Light Almond
1251L		20	120/277	Locking
	1256I	30	120/277	Ivory
	1256W	30	120/277	White
1255	1256	30	120/277	Brown
1255L	1256L	30	120/277	Locking

CATALOG NUMBER	DESCRIPTION
LOCK SWITCH REPLACEMENT KEYS	
1498	Fits switches manufactured before 1976.
1498NT	Fits switches manufactured between 1976-present.

HP Conversion Table

1221 SERIES	
15 AMP	1/2 Horsepower at 120VAC 2 Horsepower at 240VAC
20 AMP	1 Horsepower at 120VAC 2 Horsepower at 240VAC
30 AMP	2 Horsepower at 120VAC 2 Horsepower at 240VAC
1250 SERIES	
15 AMP	1/2 Horsepower at 120VAC 2 Horsepower at 240VAC
20 AMP	1 Horsepower at 120VAC 2 Horsepower at 240VAC
30 AMP	2 Horsepower at 120VAC 2 Horsepower at 240VAC

SWITCH DISCONNECTS & MANUAL MOTOR CONTROLLERS

Non-Fusible Safety Switches



Non-Fusible Safety Switches UL Listed as “Suitable as Motor Disconnect.”

Here's the first non-metallic NEMA 4X Non-Fusible Safety Switch line UL Listed as “Suitable as Motor Disconnect” — per NEC® Article 430.109(A)(6).

P&S Non-Fusible Safety Switches feature extra-tough components, including an impact-resistant Valox® NEMA 4X enclosure. And an innovative design that delivers safe, sure operation under the worst conditions. These rugged performers are available in capacities from 30 to 100 amps.

And when you take a closer look, you'll see even more to like. For example, the fits-anywhere compact design. The adjustable mounting feet that speed installation. Or the no-confusion, at-a-glance ON/OFF status indication.

See how P&S Non-Fusible Safety Switches work better for you.

SWITCH DISCONNECTS & MANUAL MOTOR CONTROLLERS

Non-Fusible Safety Switches

- A. Compact design** fits in most I-beams to provide mounting versatility, easy access, and reduced possibility of impact damage.
- B. Nonconductive, watertight, corrosion-, heat-, and impact-resistant thermoplastic enclosure** ensures NEMA 4X and 12 ratings. Withstands the harshest industrial environments.
- C. Corrosion-resistant, stainless steel captive screws** speed installation, minimize risk of lost parts, and withstand abuse.

- D. Adjustable mounting feet** can be moved to center of unit for instant strut- or pole-mounting without special brackets or harnesses.
- E. Durable, stainless steel cover-retaining chain** makes installation and maintenance more convenient.
- F. Heavy-duty, ergonomic switch handle meets OSHA Lockout/Tagout provisions** and provides plenty of grip for sure, easy operation. Black/red color coding and high-visibility ON/OFF markings

clearly indicate status from a distance and at any visual angle. Switch entry into the enclosure is offset to the side and sealed to provide enhanced water resistance.

Bottom and top wiring access options. No unnecessary openings to compromise water resistance.

Top mount auxiliary contact enables additional control functions or signal lights.

Now certified for IP69 applications.



SWITCH DISCONNECTS & MANUAL MOTOR CONTROLLERS

Non-Fusible Safety Switches Ordering Information

VOLTAGE	MAXIMUM HORSEPOWER RATING	NON-FUSIBLE SAFETY SWITCH CATALOG #	NON-FUSIBLE SAFETY SWITCH WITH AUXILIARY CONTACT** CATALOG #	NON-FUSIBLE SAFETY SWITCH WITH 3 AUXILIARY CONTACTS**	AUXILIARY CONTACT KIT*	REPLACEMENT SWITCH	REPLACEMENT SWITCH WITH AUXILIARY CONTACT	REPLACEMENT SWITCH WITH 3 AUXILIARY CONTACTS	REPLACEMENT COVER FOR STANDARD SWITCH	REPLACEMENT COVER FOR AUXILIARY TYPE
30 AMPS	600VAC									
120VAC	1 HP									
208VAC	2 HP									
240VAC	5 HP									
277VAC	3 HP									
480VAC	5 HP	PS30SS	PS30SSAX	PS30SSAX3	AX30	RS30	PS30RSAX	RS30AX3	PS30SSRC	PS30SSAXRC
600VAC	5 HP									
3ø 240VAC	10 HP									
3ø 480VAC	20 HP									
3ø 600VAC	25 HP									
60 AMPS	600VAC									
120VAC	3 HP									
240VAC	10 HP									
277VAC	15 HP									
480VAC	20 HP									
600VAC	30 HP	PS60SS	PS60SSAX	PS60SSAX3	AX60	RS60HP	RS60HPAX		PS60SSRC	PS60SSAXRC
3ø 240VAC	25 HP									
3ø 480VAC	50 HP									
3ø 600VAC	50 HP									
100 AMPS	600VAC									
120VAC	5 HP									
240VAC	15 HP									
277VAC	15 HP									
480VAC	30 HP									
600VAC	30 HP	PS100SS	PS100SSAX	PS100SSAX3	AX60	RS100	RS100AX		PS100SSRC	PS100SSAXRC
3ø 240VAC	25 HP									
3ø 480VAC	50 HP									
3ø 600VAC	50 HP									

* For replacement of side mount auxiliary contact on previous design.
 **Auxiliary contacts break before switch contacts break for use with VFD.

Mounting Feet Replacement Kit

CATALOG NUMBER	DESCRIPTION
SSMF	Mounting Feet Replacement Kit for PS30SS and PS30SSAX
SSMF2	Mounting Feet Replacement Kit for PS60/100A Switches



RS30



AX30

SWITCH DISCONNECTS & MANUAL MOTOR CONTROLLERS

Non-Fusible Safety Switches Materials of Manufacture Typical/Sample Spec

Typical Specifications

- Manufacturer's Identification PS60SS
- Description: Non-Fusible Safety Switch
- Rating: 60A, 600VAC maximum
- Enclosure Type: NEMA 4X (watertight, hosedown), 12K (dust-tight, falling dirt), IP67/IP69 suitability
- Conduit Location: Top, bottom, or back feed. Units are shipped without holes for conduit. Spot drills for locating hole saw or knockouts are provided for top, bottom, or back feed. End user decides at installation whether top, bottom, or back feed is appropriate. No closure plug kits required. Units are not provided with conduit hubs.

MATERIALS	
Enclosure Cover	Valox 357®
Enclosure Base	Valox 357®
Enclosure Gasket	Neoprene
Switch Handle	Valox 357®
Switch Handle Seal	Neoprene
Switch Key	10% Glass-Filled Nylon
Mounting Feet	Valox 357®
Mounting Feet Screws	300 Series Stainless Steel
Enclosure Assembly Screws	300 Series Stainless Steel
Enclosure Assembly Inserts	Brass (60 and 100 amp units only)
Grounding Plate	Galvanized Steel
Cover Chain	300 Series Stainless Steel

PERFORMANCE	
Electrical:	
Dielectric Voltage Withstand	3000V minimum
Maximum Working Voltage	600V RMS
Current Interrupting	Listed for current interrupting at full-rated current and voltage
Short Circuit Withstand Rating	For use on circuit capable of delivering not more than (see chart below) RMS amps at 600VAC
Operations	Mechanical: 15,000 cycles Electrical: 10,000 cycles
Auxiliary Contacts (optional)	10A @ 600VAC 1 N.O. & 1 N.C.
Mechanical:	
Impact Resistance	Per UL746C
Terminal Identification	Per UL and CSA
Product Identification	Identification and rating on external and internal labels
Mounting	External adjustable feet with five (5) positions Can be mounted directly to channel or strut (no washers required)
Environmental:	
Moisture Resistance	Per UL50, section 35, NEMA Enclosure Type 4X (watertight, hosedown) Per UL50, section 35, NEMA Enclosure Type 12 (dusttight, falling dirt) • IP66/67/69
Flammability	UL94 5VA and VO Classification
Operating Temperature	Maximum continuous: +60°C • Minimum continuous: -50°C without impact
UV Resistance	All enclosure materials are UV stable

Interrupting Ratings — RMS Symmetrical Amperes

Short Circuit Ratings: Suitable for use on circuits capable of delivering not more than (see chart below for cat. no. and application) RMS symmetrical amperes, 600VAC maximum.

CATALOG NUMBER	kA	FUSE/BREAKER	MAX SIZE
PS30SS (AX)	10	RK1	—
	65	Class J	40A
PS60SS (AX) PS100SS (AX)	10	RK1	—
	10	GE Circuit Breaker	—
	65	Class J	100A

SWITCH DISCONNECTS & MANUAL MOTOR CONTROLLERS

Non-Fusible Safety Switches Dimensions

Non-Fusible Safety Switches Dimensions

Amps	A	B	C	D	E	F	G	H	I	J	K
30	5.75	7.38	4.88	7.19	9.69	3.75	5.75	6.56	6.13	8.06	8.88
60	7.19	9.13	6.31	9.63	12.38	4.75	7.19	8.13	8.00	10.38	11.38
100	7.19	9.13	6.31	9.63	12.38	4.75	7.19	8.13	8.00	10.38	11.38

All measurements shown in inches.

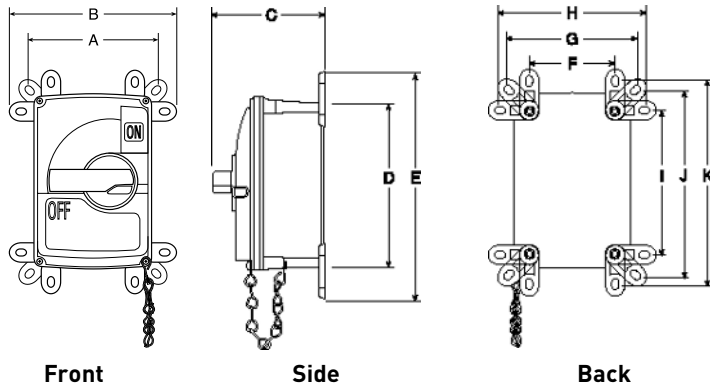

[See dimensions above.]

SWITCH DISCONNECTS & MANUAL MOTOR CONTROLLERS

Fusible Safety Switches

See blown fuses at a glance in these Fusible Safety Switches.

Looking for safety switches that cut downtime? Take a close look at these innovative P&S Fusible Safety Switches. Here's the same first-ever blown-fuse indication system that's in our pacesetter Fusible Mechanical Interlocks — with individual LED indicators for each line, patent-pending integral fuse pullers, and a hinged fuse-access door. That means no time lost to locating a blown fuse — and no time wasted in fuse replacement.

P&S Fusible Safety Switches deliver the same ultra-heavy-duty construction as our Fusible Mechanical Interlocks, too. So they provide maximum protection against water, dirt, heat, and vibration — and just about any other harsh condition you'll encounter. You get the same installation flexibility, too. With capacities available from 30 to 100 amps, there's a P&S Fusible Safety Switch that's ready to work for you in any industrial environment.



SWITCH DISCONNECTS & MANUAL MOTOR CONTROLLERS

Fusible Safety Switches

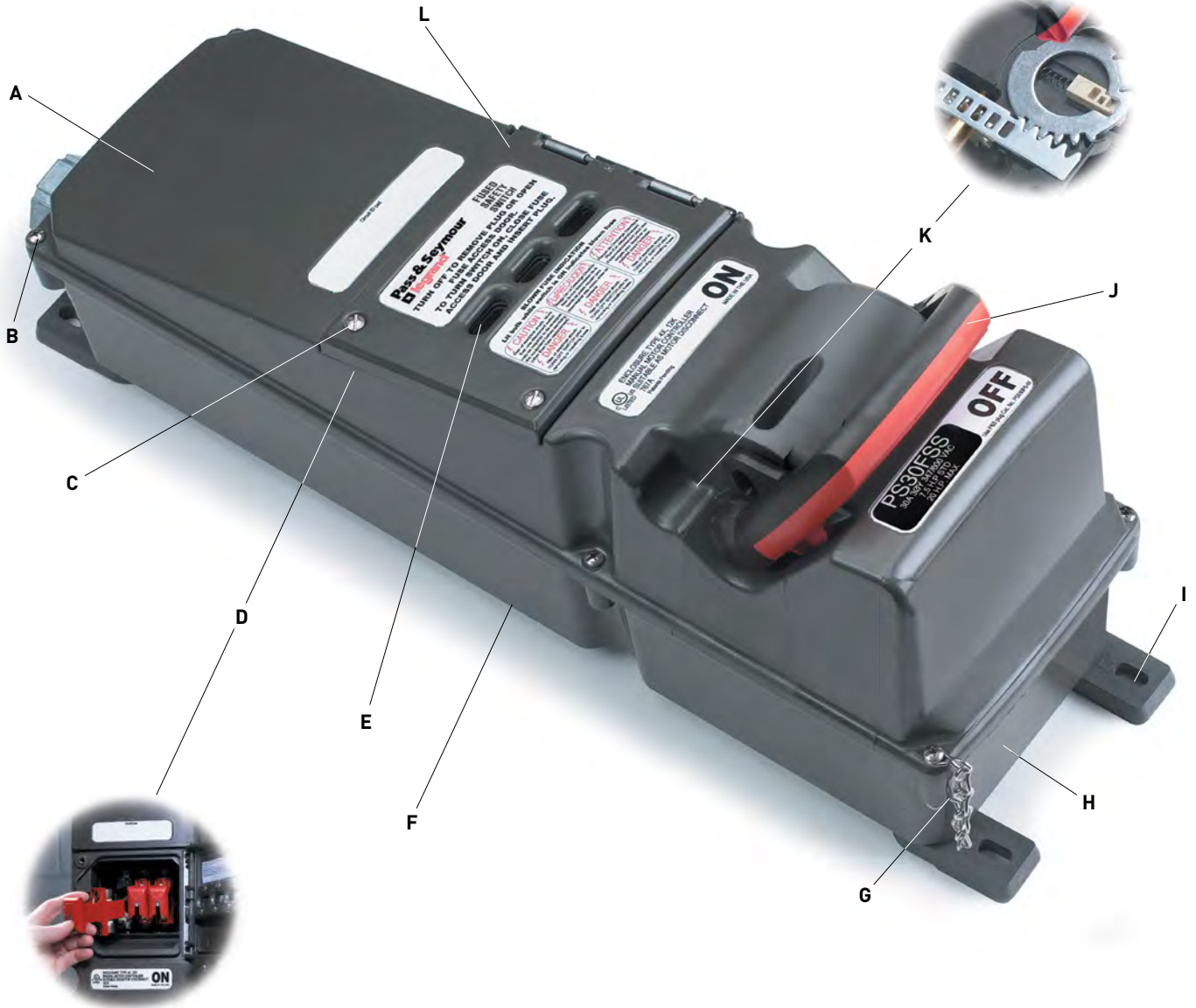

SWITCH DISCONNECTS & MANUAL MOTOR CONTROLLERS

SWITCH DISCONNECTS & MANUAL MOTOR CONTROLLERS

Fusible Safety Switches

Fusible Safety Switch Features:

- A. Compact design** fits in most I-beams to provide mounting versatility, easy access, and reduced possibility of impact damage.
- B. Corrosion-resistant, stainless steel captive screws** speed installation, minimize risk of lost parts, and withstand abuse.
- C. Captive, quick-release, stainless steel screws** speed fuse removal, ensure a watertight access door seal, and won't fall out.
- D. Patent-pending integral fuse pullers** with easy-grip ergonomics make removing and replacing blown fuses simple, comfortable, and quick.
- E. Time-saving LED indicators** identify blown fuses at a glance.
- F. Nonconductive, watertight, corrosion- and impact-resistant Valox® enclosure** ensures NEMA 4X and 12 ratings. Withstands the harshest industrial environments.
- G. Durable, stainless steel cover-retaining chain** makes installation and maintenance more convenient.
- H. Easy to drill for bottom wiring access, top wiring access — or both.** Only one catalog number per amp rating — simplifies ordering and provides maximum application flexibility.
- I. Adjustable mounting feet** can be moved to center of unit for instant strut- or pole-mounting without special brackets or harnesses. Oversized foot design eliminates the need for washers.
- J. Heavy-duty, ergonomic switch handle meets OSHA Lockout/Tagout requirements** and provides plenty of grip for sure, easy operation. Black/red color coding and high-visibility ON/OFF markings clearly indicate status from a distance and at any visual angle.
- K. Heavy-duty steel-gear switch mechanism** provides enhanced durability and extra-long service life.
- L. Hinged access door with windows** allows clear viewing of blown-fuse LED indicators and provides fast, easy access to fuse pullers.

SWITCH DISCONNECTS & MANUAL MOTOR CONTROLLERS

Fusible Safety Switches Ordering Information & Dimensions

VOLTAGE	STANDARD HORSEPOWER RATING	MAXIMUM HORSEPOWER RATING	FUSIBLE SAFETY SWITCH CATALOG #	
30 AMPS 600VAC				
120VAC	1/2 HP	2 HP	PS30FSS	
208VAC	1 HP	5 HP		
240VAC	1 1/2 HP	5 HP		
277VAC	1 1/2 HP	5 HP		
480VAC	3 HP	10 HP		
120/240VAC	1/2 HP @ 120VAC 1 1/2 HP @ 240VAC	2 HP @ 120VAC 5 HP @ 240VAC		
3Ø 240VAC	3 HP	10 HP		
3Ø 480VAC	5 HP	20 HP		
3Ø 600VAC	7 1/2 HP	20 HP		
3ØY 120/208VAC	2 HP	7 1/2 HP		
3ØY 277/480VAC	5 HP	20 HP		
3ØY 347/600VAC	7 1/2 HP	20 HP		
60 AMPS 600VAC				
120VAC	1 1/2 HP	3 HP		PS60FSS
208VAC	3 HP	7 1/2 HP		
240VAC	3 HP	10 HP		
277VAC	3 HP	10 HP		
480VAC	5 HP	20 HP		
120/240VAC	1 1/2 HP @ 120VAC 3 HP @ 240VAC	3 HP @ 120VAC 10 HP @ 240VAC		
3Ø 240VAC	5 HP	20 HP		
3Ø 480VAC	10 HP	40 HP		
3Ø 600VAC	15 HP	50 HP		
3ØY 120/208VAC	5 HP	20 HP		
3ØY 277/480VAC	10 HP	40 HP		
3ØY 347/600VAC	15 HP	50 HP		
100 AMPS 600VAC				
120VAC	2 HP	5 HP	PS100FSS	
208VAC	5 HP	10 HP		
240VAC	5 HP	15 HP		
277VAC	7 1/2 HP	15 HP		
480VAC	10 HP	30 HP		
120/240VAC	2 HP @ 120VAC 5 HP @ 240VAC	5 HP @ 120VAC 15 HP @ 240VAC		
3Ø 240VAC	10 HP	25 HP		
3Ø 480VAC	20 HP	50 HP		
3Ø 600VAC	30 HP	50 HP		
3ØY 120/208VAC	10 HP	20 HP		
3ØY 277/480VAC	20 HP	50 HP		
3ØY 347/600VAC	30 HP	50 HP		

(HP Ratings subject to change.)

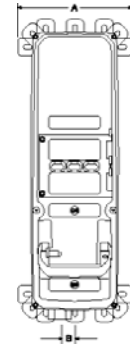

Front

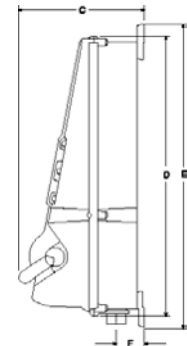

Side



Back

Hub shown at bottom of unit for reference only; may be field-installed for top or bottom entry. (See dimensions below.)

Fusible Safety Switches Dimensions

Amps	A	B	C	D	E	F	G	H	I	J	K	L
30	9.13	1.19	10.09	22.59	22.59	1.97	4.75	6.88	7.75	20.13	22.25	23.13
60	9.13	1.19	10.09	22.59	22.59	2.25	4.75	6.88	7.75	20.13	22.25	23.13
100	11.13	1.75	11.06	26.59	28.31	2.41	6.75	8.88	9.75	23.94	26.06	26.94

All measurements shown in inches.

SWITCH DISCONNECTS & MANUAL MOTOR CONTROLLERS

Fusible Safety Switches Materials of Manufacture Typical/Sample Spec

Typical Specifications

- Manufacturer's Identifications: Pass & Seymour® PS60FSS
- Description: Fusible Safety Switch
- Rating: 60A, 600VAC maximum
- Enclosure Type: NEMA 4X (watertight, hosedown), 12K (dusttight, falling dirt), IP67/IP69 suitability
- Conduit Location: Top or bottom feed. Unit shipped with no holes drilled; a top and bottom feed spot drill is provided for locating hole saw or knockout. End user decides at installation whether top or bottom feed is appropriate. No closure plug kits required.

MATERIALS	
Enclosure Cover	Valox 357®
Enclosure Base	Valox 357®
Enclosure Door	Valox 357®
Enclosure Gasket	Neoprene
Door Hinge	316 Stainless Steel
Switch Handle	Valox 357®
Switch Handle Seal	Neoprene
Shaft	Brass
Gear Mechanism	1/8" Zinc-Plated Steel
Switch Key	10% Glass-Filled Nylon
Mounting Feet	Valox 357®
Mounting Feet Screws	300 Series Stainless Steel
Enclosure Assembly Screws	300 Series Stainless Steel
Enclosure Assembly Inserts	Brass
Grounding Plate	Zinc-Plated Steel
Cover Chain	300 Series Stainless Steel
Conduit Hub	Aluminum/Zinc
	30 amp shipped with one (1) 1"
	60 amp shipped with one (1) 1 1/4"
	100 amp shipped with one (1) 1 1/2" (will also fit a 2" hub, not provided)
Viewing Slots in Fuse-Access Door	1/8" thick glass lens

PERFORMANCE	
Electrical:	
Fuse Type	Class "J"
Dielectric Voltage Withstand	3000V minimum
Maximum Working Voltage	600V RMS
Current Interrupting	Listed for current interrupting at full-rated current and voltage
Short Circuit Withstand Rating	For use on circuit capable of delivering not more than 10,000 RMS amps at receptacle voltage rating
Operations	Mechanical: 15,000 cycles Electrical: 10,000 cycles
Auxiliary Contacts	10A @ 600VAC 1 N.O. & 1 N.C.
Mechanical:	
Impact Resistance	Per UL746C
Terminal Identification	Per UL and CSA
Product Identification	Identification and rating on external and internal labels
Mounting	External adjustable feet with five (5) positions Can be mounted directly to channel or strut (no washers required)
Environmental:	
Moisture Resistance	Per UL50, section 35, NEMA Enclosure Type 4X (watertight, hosedown) Per UL50, section 35, NEMA Enclosure Type 12 (dusttight, falling dirt) IP67 suitability
Flammability	UL94 5VA and V0 Classification
Operating Temperature	Maximum continuous: +60°C Minimum continuous: -50°C without impact
UV Resistance	All enclosure materials are UV stable

SWITCH DISCONNECTS & MANUAL MOTOR CONTROLLERS

Stainless Steel Safety Switches

- A. Type 316 grade stainless steel** provides superior resistance to corrosion.
- B. 8 conduit entry points** for flexible installation options.
- C. Certified by the National Sanitation Foundation (NSF)** for hygiene requirements in food & beverage processing.
- D. Can accommodate up to 3 sets of auxiliary contacts** for control circuit applications.
- E. 3/4" standoffs on mounting feet** allow adequate space for runoff and inspection behind the switch.
- F. Water- and dust-tight enclosure rated NEMA 4X,12 and IP66,67,69** for protection against high-pressure, high-temperature water from multiple directions.
- G. High-visibility yellow and red handle** can be padlocked to meet OSHA lockout/tagout requirements.

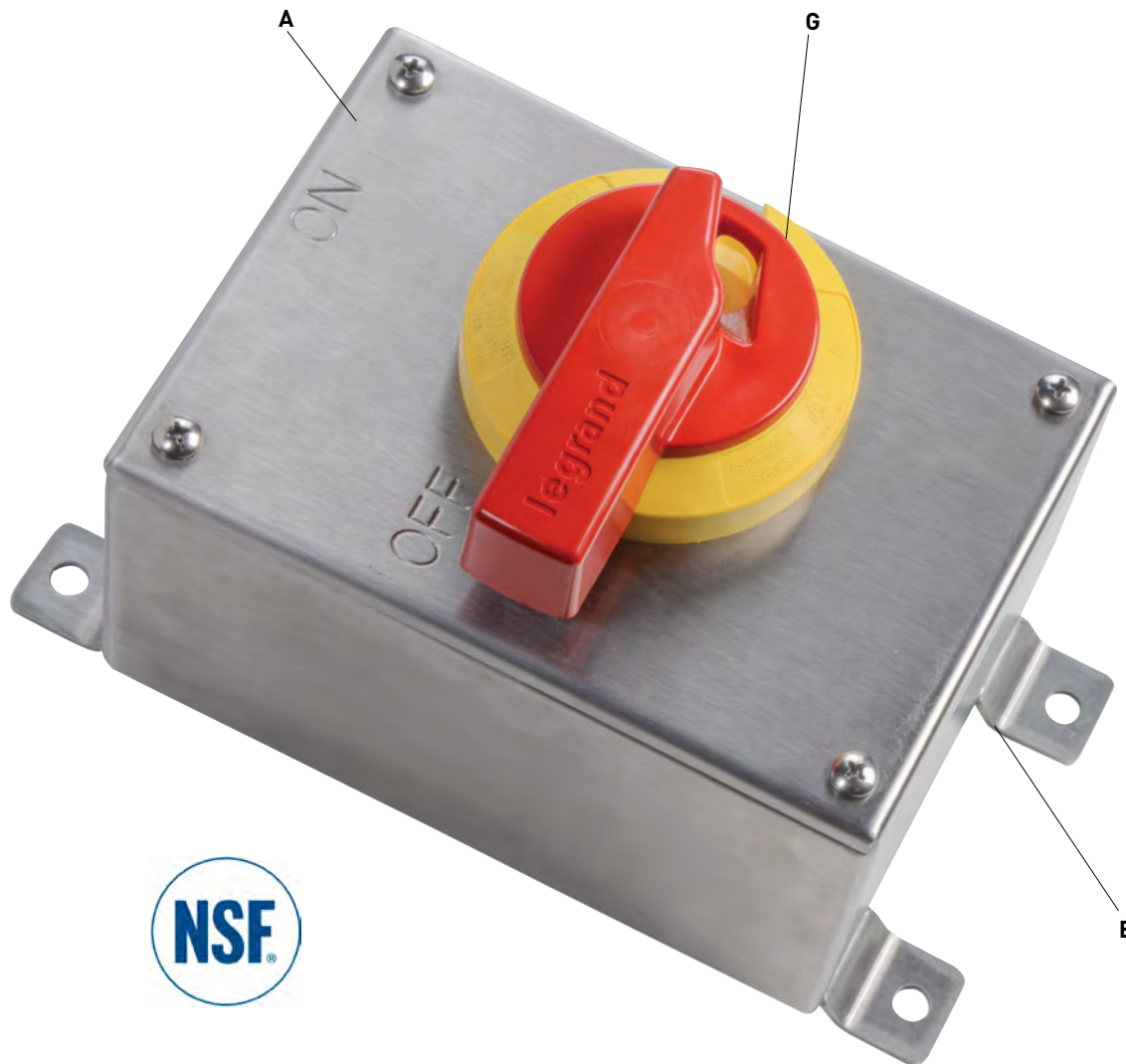

SWITCH DISCONNECTS & MANUAL MOTOR CONTROLLERS

Stainless Steel Safety Switches

VOLTAGE	MAXIMUM HORSEPOWER RATING	STAINLESS STEEL SAFETY SWITCH CATALOG NO.	STAINLESS STEEL SAFETY SWITCH WITH AUXILIARY CONTACT**	STAINLESS STEEL SAFETY SWITCH WITH 3 AUXILIARY CONTACTS**	AUXILIARY CONTACT KIT*	REPLACEMENT SWITCH	REPLACEMENT SWITCH WITH AUXILIARY CONTACT	REPLACEMENT SWITCH WITH 3 AUXILIARY CONTACTS	REPLACEMENT COVER FOR STANDARD SWITCH	REPLACEMENT COVER FOR AUXILIARY TYPE
30 AMPS	600VAC									
120VAC	1 HP	PSDS30	PSDS30AX	PSDS30AX3	AX30	RS30	RS30AX	RS30AX3	PSDS30RC	PSDS30AXRC
208VAC	2 HP									
240VAC	5 HP									
277VAC	3 HP									
480VAC	5 HP									
600VAC	5 HP									
3ø 240VAC	10 HP									
3ø 480VAC	20 HP									
3ø 600VAC	25 HP									
60 AMPS	600VAC									
120VAC	2 HP	PSDS60	PSDS60AX	—	AXD60	RS60	RS60AX	—	PSDS60RC	PSDS60AXRC
240VAC	7.5 HP									
277VAC	7.5 HP									
480VAC	10 HP									
600VAC	10 HP									
3ø 240VAC	15 HP									
3ø 480VAC	30 HP									
3ø 600VAC	40 HP									
60 AMPS HP	600VAC									
120VAC	3 HP	PSDS60HP	PSDS60HPAX	—	AX60	RS60HP	RS60HPAX	—	PSDS60HPRC	PSDS60HPAXRC
240VAC	10 HP									
277VAC	15 HP									
480VAC	20 HP									
600VAC	30 HP									
3ø 240VAC	25 HP									
3ø 480VAC	50 HP									
3ø 600VAC	50 HP									
100 AMPS	600VAC									
120VAC	5 HP	PSDS100	PSDS100AX	—	AX60	RS100	RS100AX	—	PSDS100RC	PSDS100AXRC
240VAC	15 HP									
277VAC	15 HP									
480VAC	30 HP									
600VAC	30 HP									
3ø 240VAC	25 HP									
3ø 480VAC	50 HP									
3ø 600VAC	50 HP									

* For replacement of side mount auxiliary contact on previous design.

**Auxiliary contacts break before switch contacts break for use with VFD.

SWITCH DISCONNECTS & MANUAL MOTOR CONTROLLERS

Stainless Steel Safety Switches

MATERIALS	
Enclosure Cover	316 Stainless Steel
Enclosure Base	316 Stainless Steel
Enclosure DIN Rail	316 Stainless Steel
Switch Handle	Valox 357®
Switch Base	Valox 357®
Switch Key	14% Glass-Filled Nylon
Cover Gasket	Silicone Foam
Handle Gasket	Silicone Foam
Mounting Feet	316 Stainless Steel
Cover Screws	316 Stainless Steel
Cover Screw O-Ring	Neoprene
Assembly Screws/Hardware	300 Series Stainless Steel

PERFORMANCE	
Electrical:	
Dielectric Voltage Withstand	3000V minimum
Maximum Working Voltage	600V RMS
Current Interrupting	Listed for current interrupting at full-rated current and voltage
Short Circuit Withstand Rating	For use on circuit capable of delivering not more than (see chart below) RMS amps at 600VAC
Operations	Mechanical: 10,000 cycles Electrical: 10,000 cycles
Auxiliary Contacts (optional)	10A @ 600VAC 1 N.O. & 1 N.C.
Mechanical:	
Impact Resistance	Per UL746C
Terminal Identification	Per UL and CSA
Product Identification	Identification and rating on external and internal labels
Mounting	External adjustable feet with five (5) positions* Can be mounted directly to channel or strut
Environmental:	
Moisture Resistance	Per UL50, section 35, NEMA Enclosure Type 4X (watertight, hosedown) Per UL50, section 35, NEMA Enclosure Type 12 (dusttight, falling dirt) • IP66/67/69
Flammability	UL94 5VA and VO Classification
Operating Temperature	Maximum continuous: +60°C • Minimum continuous: -50°C without impact
UV Resistance	All enclosure materials are UV stabilized

Interrupting Ratings – RMS Symmetrical Amperes

Short Circuit Ratings: Suitable for use on circuits capable of delivering not more than (see chart below for cat. no. and application) RMS symmetrical amperes, 600VAC maximum.

CAT NO.	KA	FUSE/BREAKER	MAX SIZE
PSDS30 (AX)	10	RK1	—
	65	Class J	40A
PSDS60 (AX)	10	RK1	125A
	65	Class J	70A
PSDS60HP (AX)	10	RK1	—
	10	GE Circuit Breaker	—
	65	Class J	100A

*Mounting feet are welded to enclosure with 3/4" standoff.

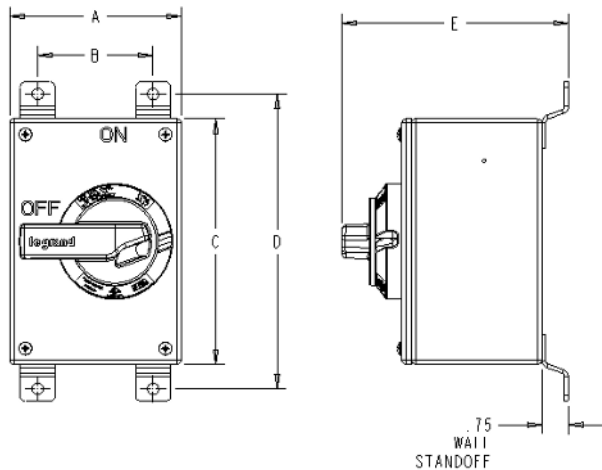

MOUNTING DIMENSION TABLE					
	A	B	C	D	E
30 Amp	4.90	3.30	7.00	8.40	6.52
60/100 Amp	7.30	5.50	10.30	11.60	7.10

SWITCH DISCONNECTS & MANUAL MOTOR CONTROLLERS

Slope Top Stainless Steel Safety Switches

- A. Type 316 grade stainless steel** provides superior resistance to corrosion.
- B. 6 conduit entry points** for flexible installation options.
- C. Certified by the National Sanitation Foundation (NSF)** for hygiene requirements in food & beverage processing.
- D. Can accommodate up to 3 sets of auxiliary contacts** for control circuit applications.
- E. 15° sloped roof** helps to facilitate run-off and minimize the harborage of contaminants.
- F. 3/4" standoffs on mounting feet** allow adequate space for runoff and inspection behind the switch.
- G. Water- and dust-tight enclosure rated NEMA 4X,12 and IP66,67,69** for protection against high-pressure, high-temperature water from multiple directions.
- H. High-visibility yellow and red handle** can be padlocked to meet OSHA lockout/tagout requirements.

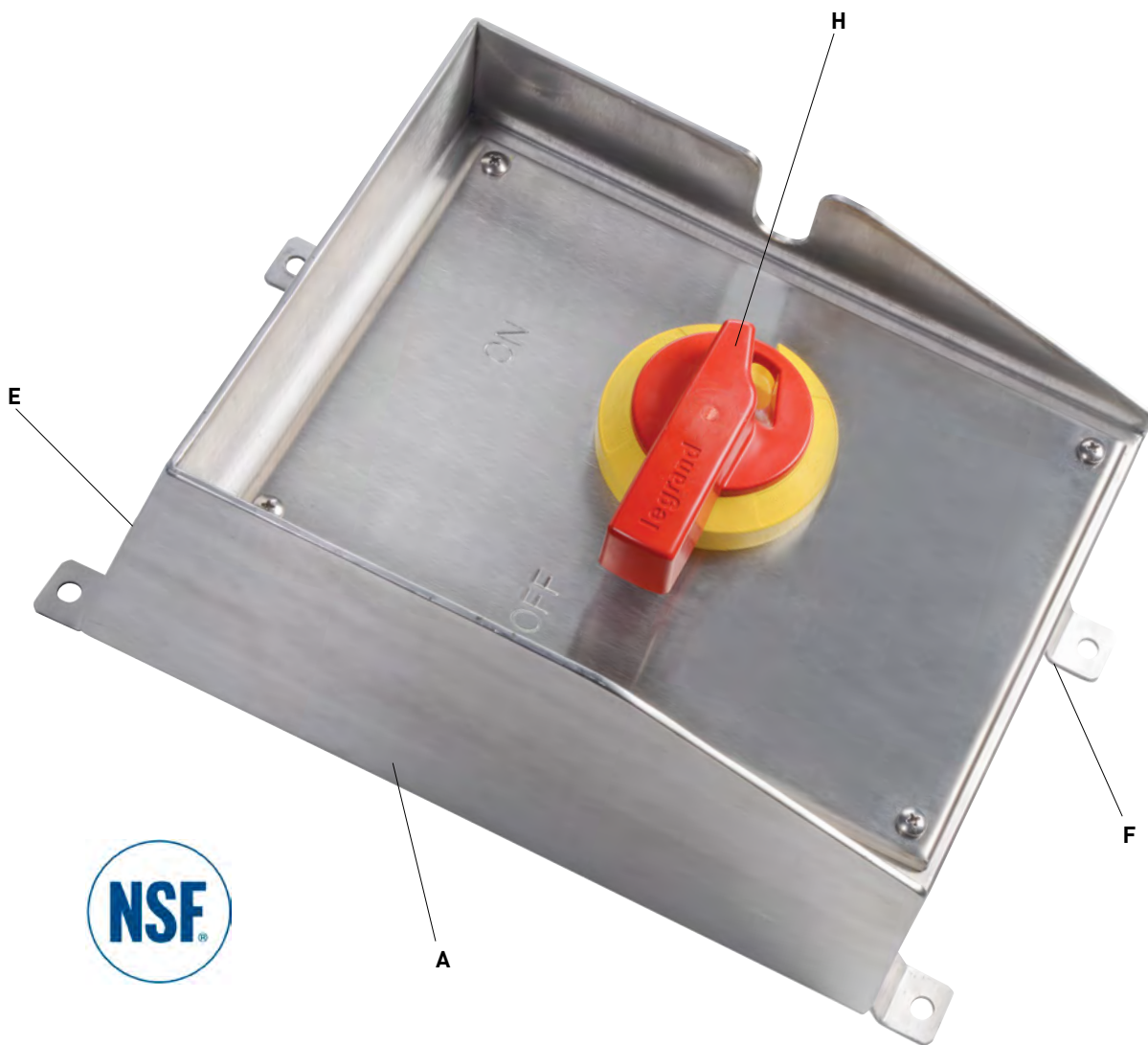

SWITCH DISCONNECTS & MANUAL MOTOR CONTROLLERS

Slope Top Stainless Steel Safety Switches

VOLTAGE	MAXIMUM HORSEPOWER RATING	SLOPE TOP SAFETY SWITCH CATALOG NO.	SLOPE TOP SAFETY SWITCH WITH AUXILIARY CONTACT**	SLOPE TOP SAFETY SWITCH WITH 3 AUXILIARY CONTACTS**	AUXILIARY CONTACT KIT*	REPLACEMENT SWITCH	REPLACEMENT SWITCH WITH AUXILIARY CONTACT	REPLACEMENT SWITCH WITH 3 AUXILIARY CONTACTS	REPLACEMENT COVER FOR STANDARD SWITCH	REPLACEMENT COVER FOR AUXILIARY TYPE
30 AMPS	600VAC									
120VAC	1 HP	PSDS30SR	PSDS30AXSR	PSDS30AX3SR	AX30	RS30	RS30AX	RS30AX3	PSDS30RC	PSDS30AXRC
208VAC	2 HP									
240VAC	5 HP									
277VAC	3 HP									
480VAC	5 HP									
600VAC	5 HP									
3ø 240VAC	10 HP									
3ø 480VAC	20 HP									
3ø 600VAC	25 HP									
60 AMPS	600VAC									
120VAC	2 HP	PSDS60SR	PSDS60AXSR	—	AXD60	RS60	RS60AX	—	PSDS60RC	PSDS60AXRC
240VAC	7.5 HP									
277VAC	7.5 HP									
480VAC	10 HP									
600VAC	10 HP									
3ø 240VAC	15 HP									
3ø 480VAC	30 HP									
3ø 600VAC	40 HP									
60 AMPS HP	600VAC									
120VAC	3 HP	PSDS60HPSR	PSDS60HPAXSR	—	AX60	RS60HP	RS60HPAX	—	PSDS60HPRC	PSDS60HPAXRC
240VAC	10 HP									
277VAC	15 HP									
480VAC	20 HP									
600VAC	30 HP									
3ø 240VAC	25 HP									
3ø 480VAC	50 HP									
3ø 600VAC	50 HP									
100 AMPS	600VAC									
120VAC	5 HP	PSDS100SR	PSDS100AXSR	—	AX60	RS100	RS100AX	—	PSDS100RC	PSDS100AXRC
240VAC	15 HP									
277VAC	15 HP									
480VAC	30 HP									
600VAC	30 HP									
3ø 240VAC	25 HP									
3ø 480VAC	50 HP									
3ø 600VAC	50 HP									

* For replacement of side mount auxiliary contact on previous design.
 **Auxiliary contacts break before switch contacts break for use with VFD.

SWITCH DISCONNECTS & MANUAL MOTOR CONTROLLERS

Slope Top Stainless Steel Safety Switches

MATERIALS	
Enclosure Cover	316 Stainless Steel
Enclosure Base	316 Stainless Steel
Enclosure DIN Rail	316 Stainless Steel
Switch Handle	Valox 357®
Switch Base	Valox 357®
Switch Key	14% Glass-Filled Nylon
Cover Gasket	Silicone Foam
Handle Gasket	Silicone Foam
Mounting Feet	316 Stainless Steel
Cover Screws	316 Stainless Steel
Cover Screw O-Ring	Neoprene
Assembly Screws/Hardware	300 Series Stainless Steel

PERFORMANCE	
Electrical:	
Dielectric Voltage Withstand	3000V minimum
Maximum Working Voltage	600V RMS
Current Interrupting	Listed for current interrupting at full-rated current and voltage
Short Circuit Withstand Rating	For use on circuit capable of delivering not more than (see chart below) RMS amps at 600VAC
Operations	Mechanical: 10,000 cycles Electrical: 10,000 cycles
Auxiliary Contacts (optional)	10A @ 600VAC 1 N.O. & 1 N.C.
Mechanical:	
Impact Resistance	Per UL746C
Terminal Identification	Per UL and CSA
Product Identification	Identification and rating on external and internal labels
Mounting	External adjustable feet with five (5) positions* Can be mounted directly to channel or strut
Environmental:	
Moisture Resistance	Per UL50, section 35, NEMA Enclosure Type 4X (watertight, hosedown) Per UL50, section 35, NEMA Enclosure Type 12 (dusttight, falling dirt) • IP66/67/69
Flammability	UL94 5VA and VO Classification
Operating Temperature	Maximum continuous: +60°C • Minimum continuous: -50°C without impact
UV Resistance	All enclosure materials are UV stabilized

Interrupting Ratings – RMS Symmetrical Amperes

Short Circuit Ratings: Suitable for use on circuits capable of delivering not more than (see chart below for cat. no. and application) RMS symmetrical amperes, 600VAC maximum.

CAT NO.	KA	FUSE/BREAKER	MAX SIZE
PSDS30 (AX)	10	RK1	—
	65	Class J	40A
PSDS60 (AX)	10	RK1	125A
	65	Class J	70A
PSDS60HP (AX)	10	RK1	—
	10	GE Circuit Breaker	—
	65	Class J	100A

*Mounting feet are welded to enclosure with 3/4" standoff.

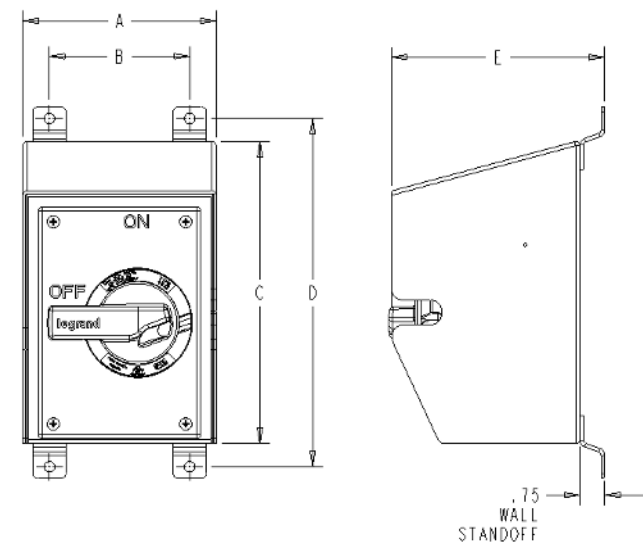

MOUNTING DIMENSION TABLE					
	A	B	C	D	E
30 Amp	5.84	4.24	9.10	10.50	6.52
60/100 Amp	8.30	6.70	12.64	14.03	7.10

SWITCH DISCONNECTS & MANUAL MOTOR CONTROLLERS

Non-Metallic Safety Switches: Proximity Switching — 16 to 80A



022171



022700



022282



022174

- Compatible with Auxiliary Contact
- IP 2X
- Double breaking on each phase
- Red rotary handle on yellow plate
- Immediate display of position
 - horizontal: open (O)
 - vertical: closed (I)

- Equipped with non-reversible terminals
- Conform to IEC EN 60947-3
- UL-cUL (USA and Canada) agreements (except boxes)
- IP 65 - IK 07 for boxes
- Can be equipped with auxiliary contact (Cat No 027700)

- Padlockable boxes for on-load breaking, isolation and locking in O position
- Equipment located remotely from a control cabinet
- Applications: breaking of CMV (controlled mechanical ventilation), motors, fixes or moving machines, air conditioners

Non-Metallic Safety Switches

■ Dimensions

Proximity switching

Boxes 2 x 2 knock-out entries: PG 16 or ISO 25
Cat. Nos 0 221 71/72/73/79/81/82/83/88/89

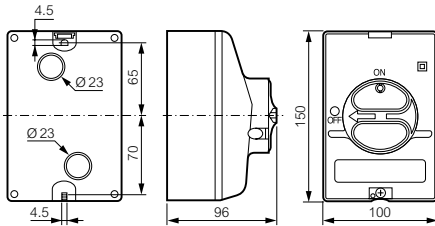

Boxes 2 x 2 knock-out entries: PG 21
Cat. Nos 0 221 74/75/84/85

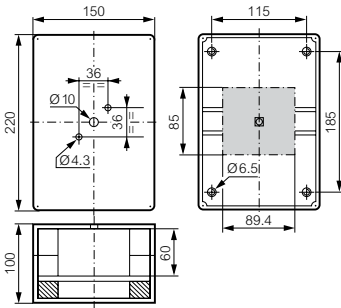

Boxes 2 x 2 knock-out entries: PG 29
Cat. Nos 0 221 76/77

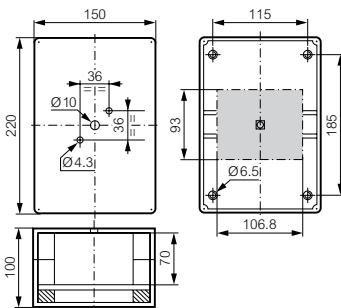

Boxes 2 x 4 knock-out entries: 2 x PG 21 and 2 x PG 29
Cat. Nos 0 221 86/87

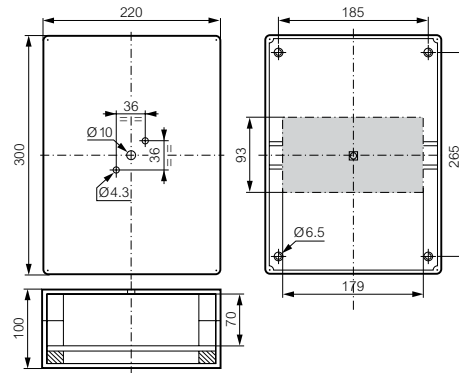

Auxiliary contact

Cat. No 0 227 00

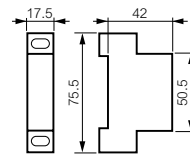

Accessories

CATALOG NUMBER	NUMBER IN PACK	DESCRIPTION
Auxiliary contact		
0 227 00	1	N/O + N/C
Labels (Marked "Main Switch")		
0 222 82	5	Duty label for padlockable faceplate

Proximity Switching

CATALOG NUMBER	NUMBER IN PACK	RATING A.
3P		
0 221 71	1	16 A
0 221 72	1	20 A
0 221 73	1	25 A
0 221 74	1	40 A
0 221 75	1	50 A
0 221 76	1	63 A
0 221 77	1	80 A
3P + N/O + N/C		
0 221 89	1	16 a
0 221 79	1	20 a
0 221 88	1	25 a

SWITCH DISCONNECTS & MANUAL MOTOR CONTROLLERS

Non-Metallic Safety Switches

Isolating Switches

Technical characteristics

Conform to IEC EN 60947-3

UL - cUL (USA - Canada) agreements. Class II box installed (if correct use of isolating caps supplied with box)

IP 40 and IP 65 - IK 07

Operating temperature: - 30 °C to + 70 °C

Box self-extinguishing: 650 °C/ 960 °C (acc. to IEC 695-2-1)

Degree of protection: IP 2X (at back of panel)

IP 65 for boxes

IP 65 for complete devices

Tropical atmosphere acc. to:

IEC 682-3 constant humid heat

IEC 682-30 cyclical humid heat

Padlockable devices

General case: up to 3 padlocks Ø4 to 8 mm

Device with 1 auxiliary contact OF: up to 3 padlocks Ø6 to 8 mm

		20 A	25 A	40 A	50 A	63 A	80 A
Rated insulation voltage U_i	V	690	690	690	690	690	690
Conventional free air thermal current (lth)							
Continuous rated current I_u	A	20	25	32	50	63	80
Conventional enclosed thermal current lthe	A	16	20	25	40	50	63
Rated impulse withstand voltage $U_{imp}^{(1)}$ (kV)		4	6	6	6	6	6
Rated operating current (A)							
AC - 21 A / 22 A							
Conforming to IEC 60947-3	A	16	25	32	50	63	80
Rated operating power (kW)							
AC - 23 A							
3 x 230 V	kW	4	5.5	5.5	15	15	18.5
	A	14.5	20	20	50	50	63
3 x 400 V	kW	7.5	7.5	11	18.5	22	30
	A	15	15	21	35	42	57
3 x 500 V	kW	7.5	7.5	11	22	30	37
	A	12	12	17	33	45	55
3 x 690 V	kW	7.5	7.5	11	18.5	22	22
	A	9	9	12	20	24	24
AC - 3							
3 x 230 V	kW	3	4	4	7.5	11	15
	A	11.5	14.5	14.5	26	38	51
3 x 400 V	kW	4	5.5	7.5	15	18.5	22
	A	8	11	15	28	35	42
3 x 500 V	kW	5.5	5.5	7.5	15	22	30
	A	9	9	12	23	33	45
3 x 690 V	kW	5.5	5.5	7.5	15	18.5	18.5
	A	6	6.5	9	16.5	20	20
Closing/breaking characteristics:							
Rated closing capacity	$A_{eff}/400 V$	710	710	710	1270	1270	1970
Rated breaking capacity	$A_{eff}/400 V$	330	330	330	800	800	800
Short circuit characteristics:							
Rated short term withstand current I_{cw}	$A_{eff}/400V/1s$	300	350	430	500	760	1100
Rated short circuit make capacity I_{cm}	kA peak/400 V	1	1	1	1.8	1.8	2.8
Short circuit current	kA $_{eff}/400 V$	6	10	10	10	10	10
With fuse gI/gG	A	16	25	32	50	63	80
Mechanical life AC - 20	million	1	0.1	0.1	0.04	0.04	0.04
Connection:							
Flexible + connector (max./min)	mm ²	6/0.5	6/0.75	6/0.75	16/1.5	16/1.5	35/2.5
Rigid	mm ²	10	10	10	25	25	50
Auxiliary contact electrical characteristics:							
Rated insulation voltage (Ui)	V	400	400	400	400	400	400
Conventional free air thermal current (lth)							
Continuous rated current (lu)	A	20	10	10	10	10	10
Rated operating current (Ie) AC - 15	230 V A	6	6	6	6	6	6
	400 V A	4	4	4	4	4	4
Protection against short circuit by fuse gG	A	16	10	10	10	10	10
Connection	flexible wire mm ² max	2 x 2.5	2 x 2.5	2 x 2.5	2 x 2.5	2 x 2.5	2 x 2.5

OCCUPANCY & VACANCY SENSORS & TIMERS



Featured Products



OCCUPANCY/VACANCY SENSORS

N-6



TIMERS

N-22



Technology	N-2
Applications	N-3
120V Wall Box Vacancy Sensors	N-4
120V Wall Box Occupancy Sensors	N-5
120V Wall Box Occupancy/Vacancy Sensors	N-6
120/277V Wall Box Occupancy/Vacancy Sensors	N-8
Passive Infrared Occupancy/Vacancy Sensors with Neutral	N-9
Commercial Occupancy/Vacancy Sensors	
Dual Technology Wall Box	N-10
Optional Neutral Passive Infrared (PIR)	N-11
Optional Neutral Dual Technology	N-12
RF Wireless Sensors	
Wireless RF Sensor and Switches	N-13
Wireless Remotes	N-14

Commercial Occupancy Sensors	
Wall or Ceiling Mount Passive Infrared (PIR)	N-15
Ceiling Mount Passive Infrared (PIR)	N-16
Ultrasonic Ceiling Mount	N-17
Dual Technology Ceiling Mount	N-18
High Bay Passive Infrared Line Voltage Occupancy Sensors	N-19
Power Packs & Auxiliary Relay Packs	N-20
Useful Calculations	N-21
Timers	N-23

OCCUPANCY & VACANCY SENSORS & TIMERS

Technology

Passive Infrared Sensors (PIR)

Using a patented fresnel lens which minimizes optical aberrations, each Wattstopper® PIR sensor breaks its coverage area into zones. Upon detecting an infrared energy change within a zone, one of the elements in the dual-element pyroelectric sensing device of an occupancy sensor generates a positive pulse. Within milliseconds, the other element produces a negative pulse and the lights are turned on. Vacancy sensors turn lights off when the room is vacant for a period of time, or when there is no infrared energy detected within a zone.

Passive infrared sensors are unable to detect occupancy around barriers, and are more effective when sensing movement across their field of sight rather than towards or away from it.

All Wattstopper PIR occupancy sensors feature:

- Patented fresnel lenses with multi-segment design
- Dual-element pyroelectric sensors
- Low-profile design
- Daylight filter systems
- Adjustable settings for time and sensitivity
- Custom Detection Signature Analysis for high immunity to RFI and EMI, and reliability
- Self-adaptive technology is available on some models

Ultrasonic Sensors

Ultrasonic sensors use a multi-directional transmitter/receiver system to broadcast ultrasonic sound waves generated by a quartz crystal oscillator, and then measure the amount of time it takes the waves to return. Movement within the area results in the sound waves returning to the sensor at a slower or faster rate, and thus occupancy is detected.

Ultrasonic sensors broadcast in three dimensions, and are therefore able to detect smaller movements than PIR sensors. Proper placement of the sensors is essential as sound waves can escape through open doorways, resulting in false triggering.

While Wattstopper ultrasonic sensors use special circuitry to filter out air-flow movement caused by HVAC equipment or fans, sensors should be kept away from breezy areas. Also, heavy carpeting and other sound-absorbing materials used in the construction of a room will reduce coverage.

Wattstopper Ultrasonic Occupancy Sensor features:

- Temperature- and humidity-resistant tuned receivers
- Signal Processing Circuitry
- Solid-state, crystal-controlled transmitter
- Adjustable controls for time and sensitivity

Dual Technology

Dual Technology sensors combine PIR and Ultrasonic sensing in one device. This minimizes false ONs and nuisance OFFs. Sensitivity adjustments and user selectable operational characteristics make dual technology sensors the most versatile, even in the most difficult installations.

Use dual technology sensors for the most demanding sensor applications. Odd shaped rooms, lots of partitions, and changing floor plans can be handled best by dual technology sensors.

Wireless RF Sensor

The Wireless RF PIR Occupancy Sensor works with Series RF Wall Switches to turn lights on and off based on occupancy. The sensor mounts on the ceiling and provides 360° passive infrared coverage.

Wireless RF Wall Switches

RF Wall Switches work with wireless occupancy sensors, and optional remote switches, to turn lights on and off based on occupancy. Models are available to control one or two switched legs in applications with or without neutral wires at the switch box.

OCCUPANCY & VACANCY SENSORS & TIMERS

Applications

Wattstopper Model	Catalog Page #	Best Suited For:
120V Wall Box Occupancy Sensors		
RS250	N-5	Storage rooms, walk-in closets, pantries, garage where a neutral is available
120V Wall Box Vacancy Sensors (T24 Compliant)		
RWU600B	N-4	Bedrooms, basements bathrooms, laundry rooms, where a neutral is available
RRW600VTC	N-4	Bedrooms, basements bathrooms, laundry rooms, where no neutral is available
3-Way 120V Wall Box Occupancy/Vacancy Sensor		
RH250	N-6	Any room/hall with multiple entrances — allows manual ON/OFF control from both locations. Can be switched between occupancy and vacancy.
CH250	N-6	Any room/hall with multiple entrances — allows manual ON/OFF control from both locations. Can be switched between occupancy and vacancy.
120V Wall Box Occupancy/Vacancy Sensor with Dimmer		
CD250W	N-7	Any room where adjustable light level is desired
Commercial Passive Infrared (PIR) Wall Box Sensors		
PTWSP250	N-8	Small offices, closets, utility rooms with no partitions or obstructions
WS250	N-8	Small offices, closets, utility rooms with no partitions or obstructions
PW301	N-11	Small offices, closets, small conference rooms with no partitions or obstructions
PW302	N-11	Small rooms with two individually-controlled loads or bi-level lighting with no partitions or obstructions
PW101, PW201	N-9	Offices, conference rooms, restrooms, lunch/break rooms, classrooms, unique areas
Commercial Passive Infrared (PIR) and Ultrasonic Wall Sensors		
DSW100	N-10	Small offices, executive suites, conference rooms, break rooms
DSW200	N-10	
Commercial Passive Infrared (PIR) Ceiling Sensors		
CI2051, CI205	N-16	Open offices, lunch, utility, storage, and computer rooms with no partitions or obstructions
CI355	N-16	Larger rooms, up to 1200 sq. ft., with open floor plans, no partitions or obstructions
Commercial Passive Infrared (PIR) Wall or Ceiling Mount Sensors		
CX1051	N-15	Hallways, or aisles
CX105	N-15	Entrances, vestibules, classrooms, for wide-angle applications
Commercial Ultrasonic Ceiling Mount Sensors		
WT605	N-17	Offices, computer, meeting, copy, and restrooms
WT1105	N-17	Offices, lunch, break and classrooms, restrooms, and conference rooms
WT2205	N-17	Offices, lunch, break and classrooms, restrooms, conference rooms, halls, storage areas
Commercial Dual Technology Sensors		
DT355	N-18	Meeting, conference and classrooms, restrooms, dressing rooms, libraries, interview rooms, testing areas, lunch and break rooms
Timers		
RT50	N-22	Closets, bathroom fans, exhaust fans, heat lamps, bedrooms
RT100	N-23	Garages, basements, laundry rooms, fans, motors, landscape lights
RT200	N-23	Exterior lights, landscape lighting, security lighting, holiday lighting
High Bay Sensors		
PSHBP120277L4	N-19	Warehouses, industrial, retail, education and institutional WL models for wet locations in these applications
HB350WL	N-19	

OCCUPANCY & VACANCY SENSORS & TIMERS

120V Wall Box Vacancy Sensors Passive Infrared (PIR)



the radiant® collection

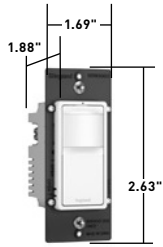

RRW600UTC

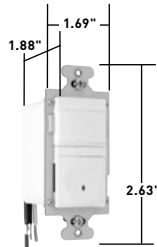

RWU600BLACC4

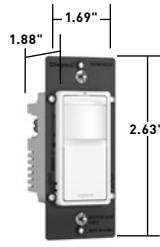

RRR600VTC

Features

- California Title 24 compliant.
- Replaces a standard light or fan single pole switch.
- Lighted switch for visibility in darkened rooms.
- Manual-ON operation.
- RW600UTC has adjustable time delay of 30 seconds to 30 minutes - others have fixed 30-minute time delay, no adjustment necessary.
- Low-profile styling with uniform color-matched lens and device.
- Coverage: 180°, max. 600 ft.2 (56m2).
- cULus listed.
- 5-year warranty.
- **RW600B only**
- Load: Incandescent, fluorescent, compact fluorescent (CFL), magnetic low-voltage (MLV) and electronic low-voltage (ELV), 1/6 hp.
- **RRW600VTC, RRRW600UTC only**
- Interchangeable face – Three colors in one box (Ivory, White, Light Almond).

CATALOG NUMBER	DESCRIPTION	VOLTAGE	LOAD	AUTO ON	MANUAL ON	SELECTABLE AUTO/MAN. ON	COLOR
SINGLE POLE VACANCY SENSORS							
RRW600BICC4	Neutral required ideal for bedrooms and baths.	120VAC 60Hz	0-600W All	No	Yes	No	Ivory
RWU600BWCC4				No	Yes	No	White
RWU600BKCC4				No	Yes	No	Black
RWU600BLACC4				No	Yes	No	Light Almond
RRR600VTC	No neutral required, ideal for bedrooms and baths. Comes with three interchangeable face colors. Part of the radiant® collection.	120VAC 60Hz	0-600W All	No	Yes	No	Ivory White Light Almond
RRR600UTC	No neutral required, ideal for bedrooms and baths. Comes with three interchangeable face colors. Part of the radiant® collection.	120VAC 60Hz	0-600W All	Yes	Yes	Yes	Ivory Light Almond White

RWU600B Wiring

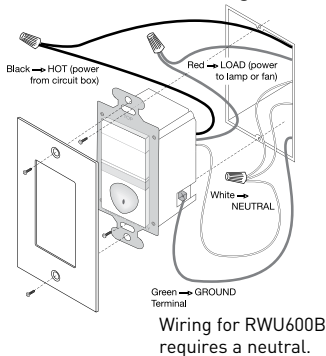

RRR600V Wiring

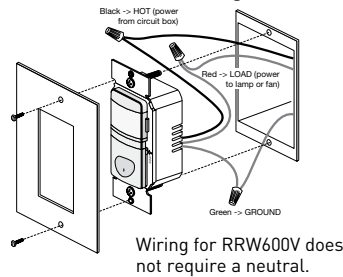

RRW600U Wiring

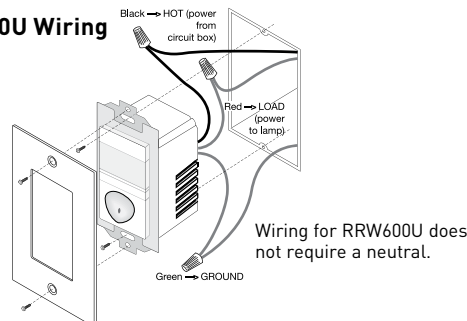

Coverage

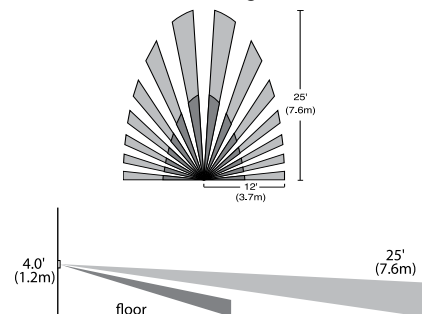

OCCUPANCY & VACANCY SENSORS & TIMERS

OCCUPANCY & VACANCY SENSORS & TIMERS

120V Wall Box Occupancy Sensors Passive Infrared (PIR)

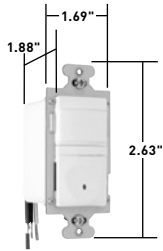

RS250

Features

- Replaces a standard light or fan single pole switch.
- Lighted switch for visibility in darkened rooms.
- Automatic-ON operation.
- Fixed five-minute time delay.
- Low-profile styling with uniform color-matched lens and device.
- Coverage: 180°, max. 600 ft.² (56m²).
- cULus listed.
- 5-year warranty.
- Works with most common residential lighting types.

RS250 only

- Load: Incandescent, fluorescent, compact fluorescent (CFL), magnetic low-voltage (MLV) and electronic low-voltage (ELV), 1/6 hp.

CATALOG NUMBER	DESCRIPTION	VOLTAGE	LOAD	AUTO ON	MANUAL ON	SELECTABLE AUTO/MAN. ON	COLOR
SINGLE POLE OCCUPANCY SENSORS							
RS250I				Yes	No	No	Ivory
RS250W	Neutral required, controls most types of lighting, ideal for storage & utility rooms	120VAC 60Hz	0-600W All	Yes	No	No	White
RS250B				Yes	No	No	Black
RS250LA				Yes	No	No	Light Almond

RS250 Wiring

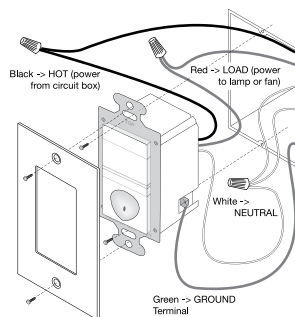

Wiring for RS250 requires a neutral.

Coverage

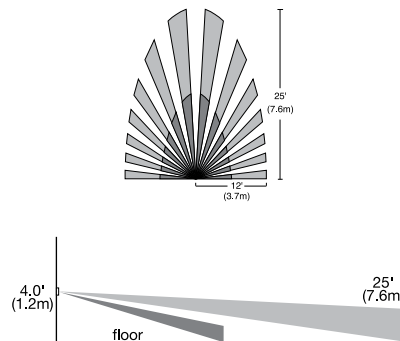

OCCUPANCY & VACANCY SENSORS & TIMERS

120V Wall Box Occupancy/Vacancy Sensors 3-Way Passive Infrared (PIR)

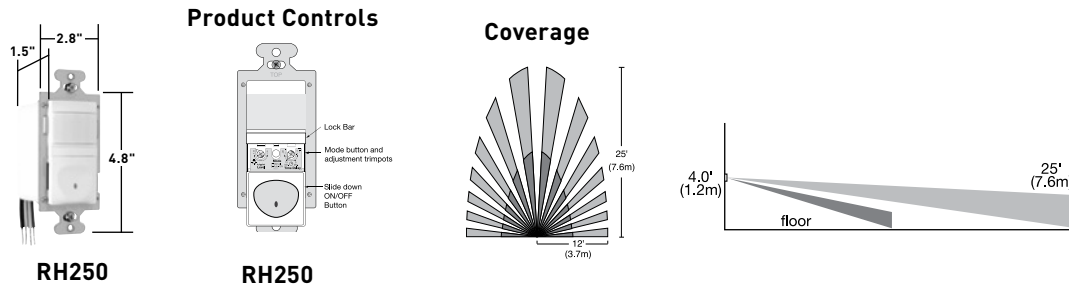

**RH250
CH250**

RH250

Dimensions for
CH250:
2.67" (L) x
1.73" (W) x 1.77" (D)

Applications

The RH250 has the flexibility to work in a variety of applications including hallways, stairways, bathrooms, living and dining rooms, and other areas with multiple entries. The RH250 vacancy sensor allows true multi-way operation with automatic ON/OFF control.

Features

- Occupancy-based control plus multi-way operation.
- Two or more RH250s connected together will allow enhanced coverage of the controlled space.
- Works with most common residential lighting types.
- Adjustable time delay of 15 seconds to 30 minutes.
- Light level sensing prevents automatic ON of lights when adequate daylight exists.
- Replaces three-way or four-way switches when used with other RH250s.
- Lighted switch for visibility in darkened rooms.
- Manual- or automatic-ON operation.
- Adjustable light level setting of 10 to 150 fc (100 to 1500 lux).
- Coverage: 180°, max. 600 ft.2 (56m2).
- cULus listed.
- 5-year warranty.
- Load: Incandescent, fluorescent, compact fluorescent (CFL), magnetic low-voltage (MLV) and electronic low-voltage (ELV), 1/6 hp.

CH250 only

- Time delay 15 seconds, 5, 15, 30 minutes.

CATALOG NUMBER	DESCRIPTION	VOLTAGE	LOAD	AUTO ON	MANUAL ON	SELECTABLE AUTO/MAN. ON	COLOR	LIGHT LEVEL SENSING
SINGLE POLE/3-WAY OCCUPANCY/VACANCY SENSORS								
RH250I*	Light-level sensing for optimum operation – ideal for rooms with multiple entrances.	120VAC 60Hz	0-600W All	Yes	Yes	Yes	Ivory	Yes
RH250W*				Yes	Yes	Yes	White	Yes
RH250B*				Yes	Yes	Yes	Black	Yes
RH250LA*				Yes	Yes	Yes	Light Almond	Yes
CH250I**	Ideal for rooms with multiple entrances.	120VAC 60Hz	0-600W All	No	Yes	No	Ivory	No
CH250W**				No	Yes	No	White	No
CH250B**				No	Yes	No	Black	No
CH250LA**				No	Yes	No	Light Almond	No

*RH250 requires an additional RH250 in multi-way circuits.

**CH250 can be used with either a momentary contact switch or an additional CH250 unit for multi-way applications. Momentary contact switches on Page A-11.

RH250 Wiring for 3-Way Operation

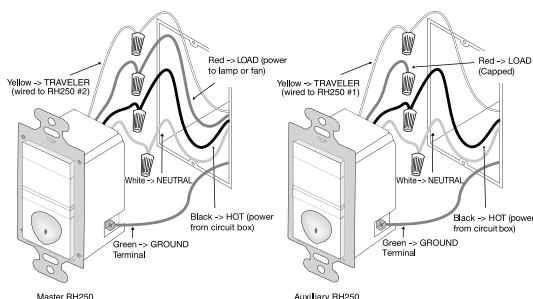

CH250 Wiring for 3-Way Operation

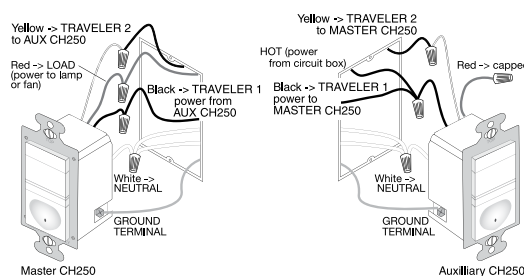

OCCUPANCY & VACANCY SENSORS & TIMERS

OCCUPANCY & VACANCY SENSORS & TIMERS

120V Wall Box Occupancy/Vacancy Sensors Passive Infrared (PIR) with Dimmer

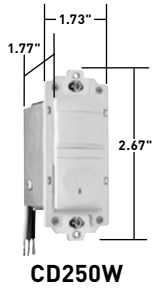

Product Controls

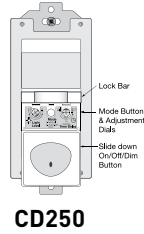

Coverage

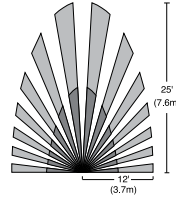

Features

- California Title 24 compliant.
- Replaces standard single pole switch or incandescent dimmer.
- Low-profile styling with uniform color-matched lens and device.
- Lighted pushbutton for visibility in darkened rooms.
- Manual-ON or automatic-ON operation.
- Adjustable time delay from 15 seconds to 30 minutes.
- Soft start technology to prolong lamp life.
- Air gap isolation switch for safe relamping.
- If enabled, light level sensing prevents automatic-ON when adequate daylight exists.
- Adjustable light level setting from 10-150 fc (100-1500 lux) for daylight sensing.
- Operating conditions: 32°-104°F (0°-40°C), 95% RH, noncondensing.
- Coverage: 180°, max. 600 ft² (56 m²).
- cULus listed.
- 5-year warranty.

CATALOG NUMBER	DESCRIPTION	VOLTAGE	LOAD	AUTO ON	MANUAL ON	SELECTABLE AUTO/MAN. ON	COLOR
OCCUPANCY/VACANCY SENSORS WITH PRESET DIMMERS							
CD250I				Yes	Yes	Yes	Ivory
CD250W	Neutral required, ideal for living, dining and family rooms, master bathrooms and bedrooms.	120VAC 60 Hz	25-500W Incandescent	Yes	Yes	Yes	White
CD250B				Yes	Yes	Yes	Black
CD250LA				Yes	Yes	Yes	Light Almond

CD250 Wiring

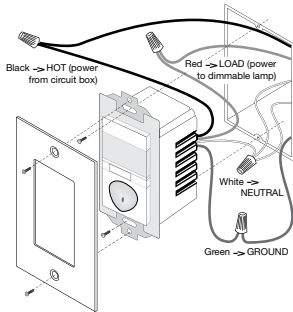

De-rating

When more than one dimmer is installed in a multi-gang box, it is necessary to reduce the maximum load on each dimmer.

- For an CD250 in either end position of a multi-gang box, reduce the maximum load by 50W.
- For an CD250 in a central position of a multi-gang box, reduce its maximum load by 100W. Mounting in a deep electrical box is recommended.

OCCUPANCY & VACANCY SENSORS & TIMERS

120/277 Wall Box Occupancy/Vacancy Sensors Wall Box Passive Infrared (PIR)

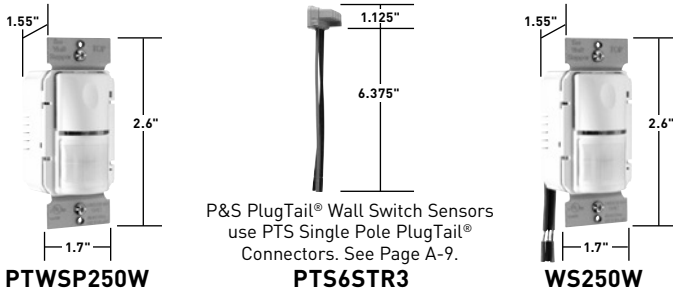

Features

- Detection Signature Analysis provides high immunity to RFI and EMI.
- Compact, decorator design replaces existing wall switch.
- Shallow back body (1")
- Integrated light level sensor works from 10 to 150 footcandles.
- Compatible with all electronic and magnetic ballasts, PL lamp ballasts, compact fluorescent.
- Adjustable time delay of 30 seconds to 30 minutes.
- Dual 120/277VAC operation.
- 30% to 60% energy savings.
- Positive detection indicator.
- No minimum load requirement.
- Adjustable sensitivity from 20% to 100%.
- Patented voltage drop protection.
- Patented Zero Crossing Circuitry.
- 180° coverage of up to 900 sq. ft.
- cULus listed.
- 5-year warranty.

Pass & Seymour® PlugTail® PTWSP250 Only

- No exposed terminals create a finger-safe application before, during, and after installation.
- Built-in connector features large brass terminal blades to ensure consistent, reliable electrical connections.

WS250 Only

- 6" flying leads

CATALOG NUMBER	DESCRIPTION	VOLTAGE	LOAD	COLOR
PASS & SEYMOUR PLUGTAIL® AUTOMATIC WALL SWITCHES – 3 WIRE TECHNOLOGY				
PTWSP250I				Ivory
PTWSP250W	PIR	120/277VAC	800W Max. at 120V	White
PTWSP250GRY	Occupancy Sensor	60Hz	1200W Max. at 277V	Gray
PTWSP250LA				Light Almond
AUTOMATIC WALL SWITCHES – 3 WIRE TECHNOLOGY				
WS250I				Ivory
WS250W	PIR	120/277VAC	800W Max. at 120V	White
WS250G	Occupancy Sensor	60Hz	1200W Max. at 277V	Gray
WS250LA				Light Almond

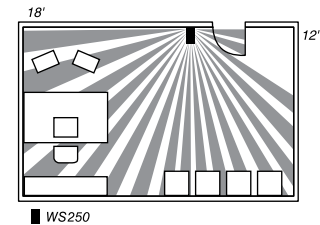
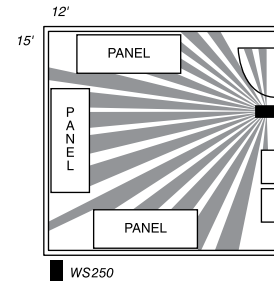

Planning a Layout

The WS250's 2-level lens provides superior coverage at desktop level by allowing the sensor to detect vertical as well as horizontal motion. Coverage shown is for walking motion. Under optimum conditions with a high level of activity and with no barriers or obstacles, coverage can reach a maximum of 900 square feet. Under a typical, desktop level of activity, when mounted at 4 feet, coverage is 300 square feet.

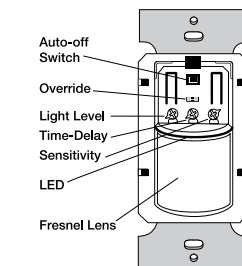

Factory settings: 30 min. time delay, maximum light level and sensitivity

Technical Specifications on Page U-160.

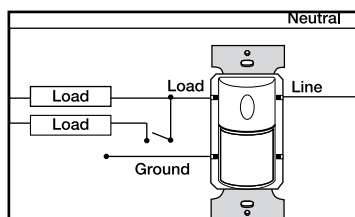

Manual Bi-level Lighting – WS250

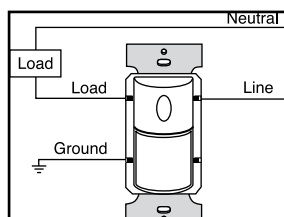

Single Level Lighting – WS250

OCCUPANCY & VACANCY SENSORS & TIMERS

Passive Infrared Occupancy/Vacancy Sensors with Neutral

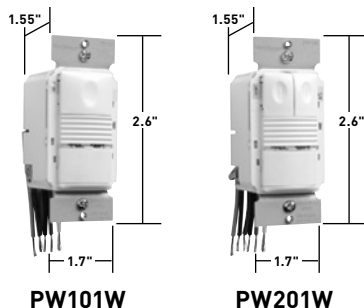

PW101W

PW201W

Features

- Detection signature processing eliminates false triggers and provides immunity to RFI and EMI.
- Zero-crossing for long relay life.
- Vandal-resistant lens combines precise coverage with durability.
- Choice of Auto-ON or Manual-ON operation.
- Auto adjustable time delays: automatic, fixed (5, 10, 15, 20, 25 or 30 minutes), walk-through, test-mode.
- Selectable time delay automatically adjusts for maximum savings.
- Walk-through mode turns lights off 3 minutes after the area is initially occupied – ideal for brief visits such as mail delivery.
- Selectable test mode allows quick and easy adjustments.
- Selectable audible alert for impending shutoff.
- In AUTO-ON mode, if the sensor is manually turned OFF, AUTO-ON will not enable until no motion is detected for 5 minutes. This prevents the light from turning ON when it was intended they remain OFF. Ideal for presentations.
- LED indicates occupancy detection.
- Built-in light level sensing with simple, one-step setup.
- Override mode allows sensor to operate as a service switch in the unlikely event of a failure.
- NEMA WD 7 guideline utilized for coverage testing.
- Sensitivity adjustment: PIR (high/low).
- Coverage: 180°, up to 1050 sq. ft.; major motion 35' x 30'; minor motion 20' x 15'.
- cULus listed.
- 5-year warranty.
- Load: Incandescent, fluorescent, compact fluorescent (CFL), magnetic low-voltage (MLV) and electronic low-voltage (ELV), 1/6 hp

CATALOG NUMBER	DESCRIPTION	COVERAGE	VOLTAGE	LOAD RATING	COLOR
PASSIVE INFRARED OCCUPANCY/VACANCY SENSORS WITH NEUTRAL					
PW101I PW101W PW101G PW101LA	PIR Occupancy/Vacancy Sensor with Neutral	Major Coverage: 35' x 30'; Minor Coverage: 20' x 15'	120/230/277 VAC, 50/60 Hz	@120VAC 0-800W tungsten or ballast, 1/6 HP; @277VAC 0-1200W ballast	Ivory White Gray Light Almond
PW201I PW201W PW201G PW201LA	Bi-Level PIR Occupancy/Vacancy Sensor with Neutral	Major Coverage: 35' x 30'; Minor Coverage: 20' x 15'	120/230/277 VAC, 50/60 Hz	@120VAC 0-800W tungsten or ballast, 1/6 HP; @277VAC 0-1200W ballast	Ivory White Gray Light Almond

OCCUPANCY & VACANCY SENSORS & TIMERS

Commercial Occupancy/Vacancy Sensors Dual Technology Wall Box

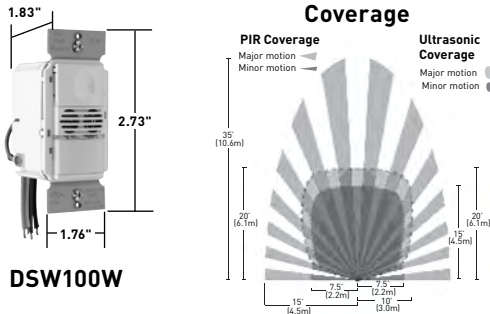

Features

- Adjusts time delays automatically based on actual usage patterns
- Assigns short delays (as low as 7 minutes) when the space is typically vacant, and longer delays (up to 30 minutes) for busier times
- Differentiates electrical noise from human motion
- Fixed mode – 5, 15 or 30 minutes
- Walk-through mode – turns lights off 3 minutes after the room is initially occupied if no motion is detected after 30 seconds.
- Test mode – allows quick and easy adjustments.
- Sensitivity adjustment.
- Color-matched lenses and low profile for appealing design.
- Choice of auto-ON or manual-ON operation.
- Fast, easy installation/switch-out.
- Zero-crossing for long relay life.
- High sensitivity and dense coverage for exceptional performance.
- cULus listed.
- 5-year warranty.
- DSW200 offers bi-level control of two loads independently from the same box.
 - Built-in sensor holds secondary lights off until daylight levels drop
 - Each relay can be set for automatic or manual ON
 - Dual ON/OFF buttons can control each of the loads manually as well

CATALOG NUMBER	DESCRIPTION	VOLTAGE	LOAD	COVERAGE	COLOR
DUAL TECHNOLOGY WALL SWITCH SENSORS					
DSW1001	Dual Technology Wall Switch Sensor	120/230/277VAC, 50/60Hz	120VAC, 0-800W ballast or tungsten, 1/6HP 230/277VAC, 0-1200 ballast	1050 sq. ft	Ivory
DSW100W					White
DSW100B					Black
DSW100G					Gray
DSW100LA	Light Almond				
DSW2001	Bi-Level Dual Technology Wall Switch Sensor	120/230/277VAC, 50/60Hz	120VAC, 0-800W ballast or tungsten, 1/6HP 230/277VAC, 0-1200 ballast	1050 sq. ft	Ivory
DSW200W					White
DSW200B					Black
DSW200G					Gray
DSW200LA					Light Almond

OCCUPANCY & VACANCY SENSORS & TIMERS

Technical Specifications on Page U-161.

OCCUPANCY & VACANCY SENSORS & TIMERS



Commercial Occupancy/Vacancy Sensors

Optional Neutral Passive Infrared (PIR) Occupancy Sensors

Compatible out of the box with existing wiring.

Optional neutral occupancy sensors turn complex retrofits into easy projects. Legrand optional neutral occupancy sensors make retrofit projects simple. You choose whether or not the neutral is connected.

Now you can decide whether or not you need a neutral.

NO configuration is required. Just connect the flying leads as you would for any no-neutral sensor. Then, if there's a neutral in the switch box, connect it to the terminal in one easy step. The sensor does the rest – automatically.

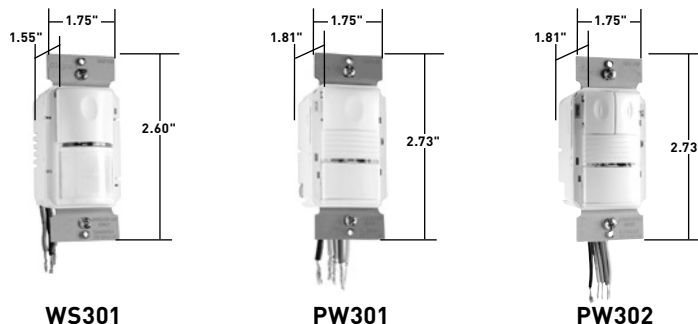

Features

- Single relay, PIR, automatic-ON (WS301).
- Single relay, PIR factory configured for manual-ON; multi-way and light level control features (PW301).
- Dual relay, PIR, factory configured for automatic-ON to 50%; multi-way and light level control features (PW302).
- Multi-way models ensure extended coverage and full-function 3-way or 4-way control.

WS301

- 180° coverage, maximum of 900 sq. ft.
- Shallow (1") back housing and flying leads for easy installation.
- Built-in light level sensor.
- Optional neutral connection with break-off tab to expose neutral terminals.
- 120/277 VAC models.
- Button provides positive tactile feedback.

PW301/PW302

- 180° coverage, maximum of 1050 sq. ft.
- High sensitivity and dense coverage for exceptional performance.
- Color-matched lens and low profile for appealing design.
- Defaults to Manual-ON operation for maximum energy savings.
- Optional neutral connection with break-off tab to expose neutral terminals.
- 120/277 VAC and 347 VAC models.
- PW302 – Two relays for control of two separate lighting loads or circuits.
- Allows multi-way control from one of up to four control locations.

CATALOG NUMBER	DESCRIPTION	VOLTAGE	LOAD	COVERAGE	COLOR
OPTIONAL NEUTRAL PASSIVE INFRARED OCCUPANCY SENSORS					
WS301I WS301W WS301B WS301G WS301LA	PIR, Single Pole, Single Relay, Optional Neutral	120 VAC; 60 Hz or 277 VAC; 60 Hz	@ 120 VAC, 0-800 W ballast or tungsten or 1/6 hp @ 277 VAC 0-1200 W ballast	900 sq ft.	Ivory White Black Gray Light Almond
PW301I PW301W PW301B PW301G PW301LA	PIR, Multi-way, Single Relay, Optional Neutral	120VAC; 50/60Hz or 277VAC; 50/60Hz	120VAC, 0-1000W ballast, LED, tungsten, 1/6 hp or @ 277VAC 0-1200W ballast, LED, 1/6 hp	1050 sq ft	Ivory White Black Gray Light Almond
PW302I PW302W PW302B PW302G PW302LA	PIR, Multi-way, Dual Relay, Optional Neutral	120VAC; 50/60Hz or 277VAC; 50/60Hz	120VAC, 0-800W ballast, LED, tungsten, 1/6 hp or @ 277VAC 0-1000W ballast, LED, 1/6 hp	1050 sq ft	Ivory White Black Gray Light Almond

OCCUPANCY & VACANCY SENSORS & TIMERS

Commercial Occupancy/Vacancy Sensors

Optional Neutral Dual Technology Occupancy Sensors

Compatible out of the box with existing wiring.

Optional neutral occupancy sensors turn complex retrofits into easy projects. Legrand optional neutral occupancy sensors make retrofit projects simple. You choose whether or not the neutral is connected.

Now you can decide whether or not you need a neutral.

NO configuration is required. Just connect the flying leads as you would for any no-neutral sensor. Then, if there's a neutral in the switch box, connect it to the terminal in one easy step. The sensor does the rest – automatically.

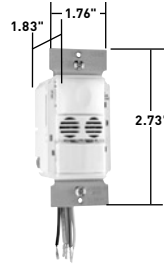

DSW301

Features

- Single relay, dual technology factory configured for manual-ON; multi-way and light level control features (DSW301).
- Dual relay, dual technology factory configured for automatic-ON to 50%; multi-way and light level control features (DSW302).
- Multi-way models ensure extended coverage and full-function 3-way or 4-way control.

WDT301/WDT321

- 180° coverage, maximum of 1050 sq. ft.
- High sensitivity and dense coverage for exceptional performance.
- Color-matched lens and low profile for appealing design.
- Optional neutral connection with break-off tab to expose neutral terminals.
- DSW302 Two relays for control of two separate lighting loads or circuits.

- Defaults to Auto-ON at 50% operation for maximum energy savings.
- 120/277 VAC and 347 VAC models.
- Allows multi-way control from one of up to four control locations.

CATALOG NUMBER	DESCRIPTION	VOLTAGE	LOAD	COVERAGE	COLOR
OPTIONAL NEUTRAL PASSIVE INFRARED OCCUPANCY SENSORS					
DSW3011	Dual Tech, Multi-way, Single Relay, Optional Neutral	120VAC; 50/60Hz or 277VAC; 50/60Hz	120VAC, 0-1000W ballast, LED, tungsten, 1/6 hp or @ 277VAC 0-1200W ballast, LED, 1/6 hp	1050 sq ft.	Ivory
DSW301W					White
DSW301B					Black
DSW301G					Gray
DSW301LA					Light Almond
DSW3021	Dual Tech, Multi-way, Dual Relay, Optional Neutral	120VAC; 50/60Hz or 277VAC; 50/60Hz	@ 120 VAC, 0-800 W ballast or tungsten or 1/6 hp @ 277 VAC 0-1200 W ballast	1050 sq ft	Ivory
DSW302W					White
DSW302B					Black
DSW302G					Gray
DSW302LA					Light Almond

OCCUPANCY & VACANCY SENSORS & TIMERS



Commercial Occupancy/Vacancy Sensors Wireless RF Passive Infrared (PIR)

Sensors and Remotes

Wireless Sensors for challenging installs

Sometimes you can't just put a wired occupancy solution in place. That's where the Legrand RF wireless solutions come into play. Built on mature, reliable and sustainable technology, wireless sensors and switches make it easy and cost effective to manage energy, especially in existing buildings. Typical applications perfect for wireless RF solutions are historic buildings where wiring is not

permissible; wood, plaster, or drywall ceilings; and asbestos or other materials in the plenum with no conduit to support 3-way switching.

The solution consists of a Wireless RF Passive Infrared (PIR) Occupancy Sensor (batteries not required), RF Wall Switches, and in-wall and handheld self-powered RF remotes.

Wireless RF Sensor – ECS1200

The Wireless RF Passive Infrared (PIR) Occupancy Sensor works with Series RF Wall Switches to turn lights on and off based on occupancy. The sensor mounts on the ceiling and provides 360° passive infrared coverage.

Features

- Self-powered extended range ceiling mount sensor.
- Photovoltaic panels power sensor; no batteries required.
- Ladder-free installation options.
- Transmitter for wireless communication with RF wall switches.
- Works with 1- and 2-relay RF wall switches.
- Adds energy code compliance without the need for rewiring.

CATALOG NUMBER	DESCRIPTION	VOLTAGE	LOAD	COVERAGE	COLOR
WIRELESS RF PIR OCCUPANCY SENSOR					
ECS1200	Wireless RF PIR Occupancy Sensor	N/A - Power Supplied by built in Photovoltaic Cells or Optional CR2032 Battery	N/A	1900 sq ft	White



ECS1200
Dimensions (inches)
4.92 x 3.43 x 1.26 (LWD)

Wireless RF Switches – EWS100/EWS101 & EWS200/EWS201

EWS100 Series RF Wall Switches work with ECS1200 wireless occupancy sensors, and optional ERS100 and EHR100 remote switches, to turn lights on and off based on occupancy. Models are available to control one or two switched legs in applications with or without neutral wires at the switch box.

Features

- Single and dual relay 120/277 VAC RF-enabled switches.
- Replace standard wall switches for energy code compliance without the need for rewiring.
- Receiver for wireless communication with RF occupancy sensors and remote switches.
- Default settings for most energy-efficient operating mode out of the box.
- Loads can be assigned to either button (dual relay switches).

CATALOG NUMBER	DESCRIPTION	VOLTAGE	LOAD	COVERAGE	COLOR
RF WALL SWITCHES					
EWS100I EWS100W EWS100BK EWS100GRY EWS100LA	Single Relay RF Wall Switch, no neutral	120/277 VAC 60Hz	Load 1: @ 120VAC, 15-800W or 1/6hp @ 277VAC, 30-1200W Load 2: @ 120VAC, 0-800W or 1/6hp @ 277VAC, 0-1200W	N/A	Ivory White Black Gray Light Almond
EWS101I EWS101W EWS101BK EWS101GRY EWS101LA	Dual Relay RF Wall Switch, no neutral	120/277 VAC 60Hz	Load 1: @ 120VAC, 15-800W or 1/6hp @ 277VAC, 30-1200W Load 2: @ 120VAC, 0-800W or 1/6hp @ 277VAC, 0-1200W	N/A	Ivory White Black Gray Light Almond
EWS200I EWS200W EWS200BK EWS200GRY EWS200LA	Single Relay RF Wall Switch, with neutral	120/277 VAC 60Hz	Loads 1 & 2: @ 120VAC, 0-800W or 1/6hp @ 277VAC, 0-1200W	N/A	Ivory White Black Gray Light Almond
EWS201I EWS201W EWS201BK EWS201GRY EWS201LA	Dual Relay RF Wall Switch, with neutral	120/277 VAC 60Hz	Loads 1 & 2: @ 120VAC, 0-800W or 1/6hp @ 277VAC, 0-1200W	N/A	Ivory White Black Gray Light Almond



EWS100 EWS200
Dimensions (inches)
4.15 x 1.75 x 1.31 (LWD)

All devices listed on this page conform to NEMA WD-1 and WD-6.

OCCUPANCY & VACANCY SENSORS & TIMERS

Commercial Occupancy/Vacancy Sensors Wireless Self-Powered RF Remotes

Wireless Sensors for challenging installs

Sometimes you can't just put a wired occupancy solution in place. That's where the Legrand RF wireless solutions come into play. Built on mature, reliable and sustainable technology, wireless sensors and switches make it easy and cost effective to manage energy, especially in existing buildings. Typical applications perfect for wireless RF solutions are historic buildings where wiring is not

permissible; wood, plaster or drywall ceilings; and asbestos or other materials in the plenum with no conduit to support 3-way switching.

The solution consists of a Wireless RF Passive Infrared (PIR) Occupancy Sensor (batteries not required), RF Wall Switches, and in-wall and handheld self-powered RF remotes.

Wireless Wallbox Remotes ERS100/ERS200

ERS100 Series remote switches provide wireless remote control of lighting loads wired to EWS100 Series RF Wall Switches. They do not require any electrical connections or batteries for operation. Models are available with one or two control buttons in a single-gang device.

Features

- Wireless 1- and 2-button wall switches.
- Mount in standard J-box.
- Provide multi-way control with no wiring or batteries.
- Transmitter for wireless communication with RF wall switches.
- Work with 1- and 2-relay RF wall switches.
- Radio transmission range up to 150°.

CATALOG NUMBER	DESCRIPTION	VOLTAGE	LOAD	COVERAGE	COLOR
RF SELF-POWERED RF REMOTE SWITCHES					
ERS100I	1-Button RF remote wall switch	Self-powered when switch is pressed	N/A	N/A	Ivory
ERS100W					White
ERS100BK					Black
ERS100GRY					Gray
ERS100LA					Light Almond
ERS200I	2-Button RF Remote wall switch	Self-powered when switch is pressed	N/A	N/A	Ivory
ERS200W					White
ERS200BK					Black
ERS200GRY					Gray
ERS200LA					Light Almond



ERS100 ERS200
Dimensions (inches)
4.14 x 1.69 x .75 (LWD)

Wireless Handheld Remotes EHR100/EHR200

EHR100 Series handheld remotes provide wireless remote control of lighting loads wired to ESW100 Series RF Wall Switches. They do not require any electrical connections or batteries for operation. Models are available with one or two control buttons.

Features

- Wireless 1- and 2-button handheld or wall mount switches.
- Provide multi-way control with no wiring or batteries.
- Transmitter for wireless communication with RF wall switches.
- Work with 1- and 2-relay RF wall switches.
- Radio transmission range up to 150°.

CATALOG NUMBER	DESCRIPTION	VOLTAGE	LOAD	COVERAGE	COLOR
RF SELF-POWERED RF HANDHELD REMOTE					
EHR100I	1-Button RF remote wall switch	Self-powered when switch is pressed	N/A	N/A	Ivory
EHR100W					White
EHR100BK					Black
EHR100GRY					Gray
EHR100LA					Light Almond
EHR200I	2-Button RF Remote wall switch	Self-powered when switch is pressed	N/A	N/A	Ivory
EHR200W					White
EHR200BK					Black
EHR200GRY					Gray
EHR200LA					Light Almond



EHR100 EHR200
Dimensions (inches)
4.72 x 1.97 x .87 (LWD)

OCCUPANCY & VACANCY SENSORS & TIMERS

Commercial Occupancy Sensors Wall or Ceiling Mount Passive Infrared (PIR)

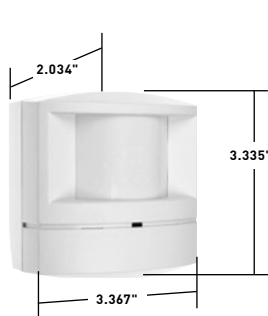

**CX1051
CX105**

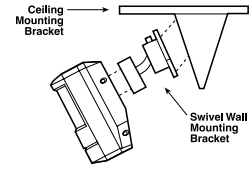
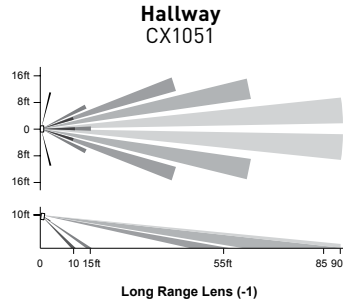
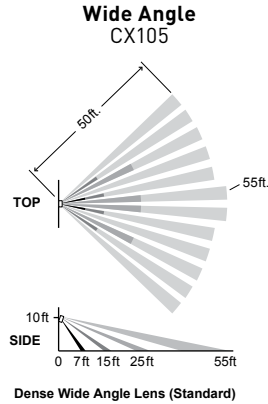

For best results, the bracket should be used in every installation to allow for greatest flexibility of adjustment. Brackets are included with each unit.

For best results, the bracket should be used in every installation to allow for greatest flexibility of adjustment. Brackets are included with each unit.

Technical Specifications on Pages U-162 and U-163.

Features

- Detection Signature Analysis provides high immunity to RFI and EMI.
- 2 coverage patterns to choose from.
- Wall mount or ceiling mount.
- Adjustable sensitivity settings.
- Digital time delay from 15 seconds to 30 minutes.
- Dual-element, temperature-compensated pyroelectric sensor.
- LED occupancy detection indicator.
- Compatible with 120VAC or 277VAC, 60 Hz lighting systems.
- Class 2 low-voltage device.
- Positive detection indicator.
- cULus listed.
- 5-year warranty.

CATALOG NUMBER	DESCRIPTION	VOLTAGE	CURRENT DRAW	COVERAGE	COLOR
WALL/CEILING MOUNT SENSORS					
CX105	Wide Angle PIR Occupancy Sensor	24VDC	8mA	Up to 2000 sq. ft.	White
CX1051	Long Range PIR Occupancy Sensor	24VDC	8mA	Up to 90 linear ft.	White

Reference Page N-20 for Power Packs.

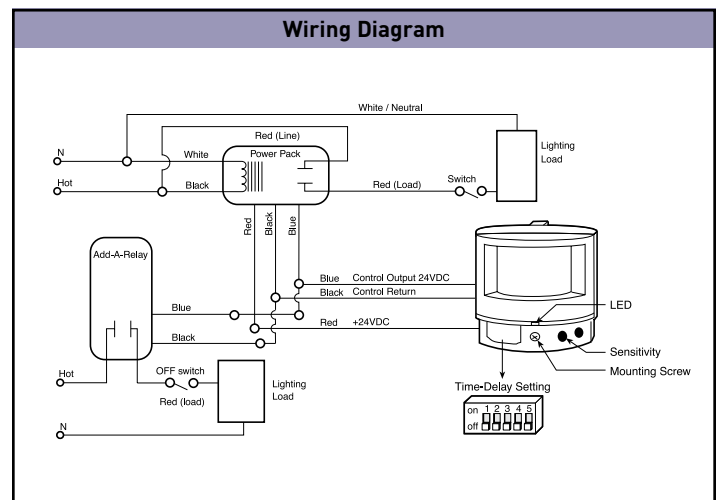
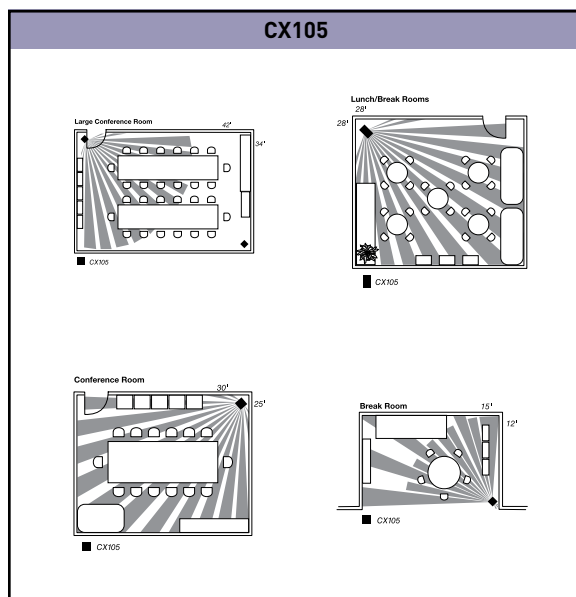
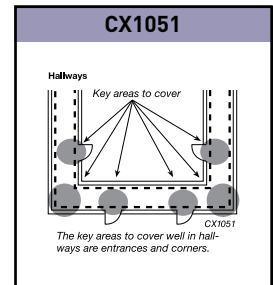

OCCUPANCY & VACANCY SENSORS & TIMERS

Commercial Occupancy Sensors Ceiling Mount Passive Infrared (PIR)



CI2051
CI205

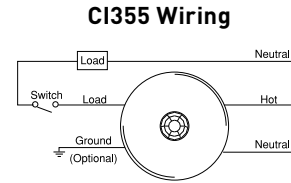
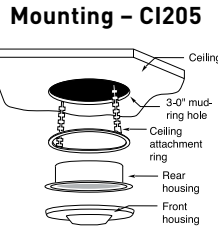
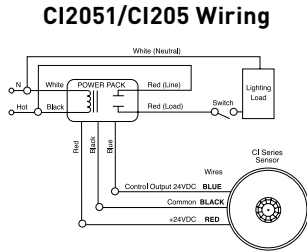

Features

- ASIC technology reduces components and enhances reliability.
- Pulse count processing eliminates false offs without reducing sensitivity.
- Detection signature analysis eliminates false triggers and provides immunity to RFI and EMI.
- Low-profile design ensures a clean and uncluttered ceiling appearance.
- User-adjustable time delay from 15 seconds to 30 minutes by two minute increments.
- Sensitivity is programmed through a DIP switch and has four settings from minimum to maximum.
- Dual-element, temperature compensated pyro-electric sensor.
- Mounting options: ceiling tile or 3.0 inch round mudring.
- Units per power pack: up to 13.
- cULus listed.
- 5-year warranty.

CATALOG NUMBER	DESCRIPTION	RATING	COVERAGE	OVERRIDE AND OUTPUT DISABLE	COLOR
LOW-PROFILE CEILING MOUNT SENSORS					
CI2051	PIR Occupancy Sensor	24VDC Input, requires Power Pack 11mA	360°, 500 sq. ft.	No	White
CI205	PIR Occupancy Sensor		360°, 1200 sq. ft.	No	White
CI355	PIR Occupancy Sensor	0-800W Ballast/Tungsten @ 120V 0-1200W Ballast @ 277V 0-1500W Ballast @ 347V	360°, 1200 sq. ft.	No	White

Reference Page N-20 for Power Packs.
*Does not require power pack.

Coverage

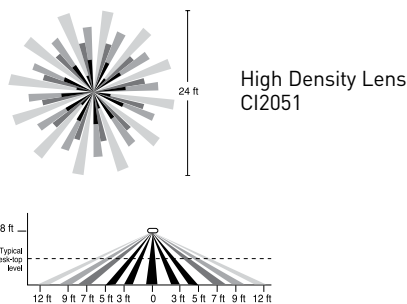
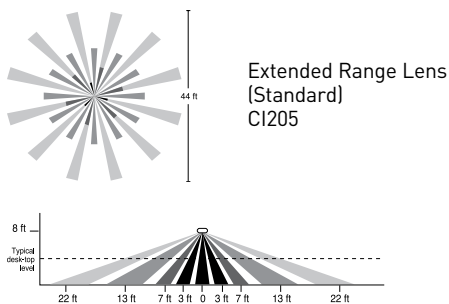

Technical Specifications on Page U-164.

DIP Switch Settings

DIP Switch #	1	2	3	4	5	6
Time Delays						
15 seconds	●	●	●	●	●	●
2 minutes	-	-	●	●	●	●
4 minutes	-	●	●	●	●	●
6 minutes	-	-	●	●	●	●
8 minutes	-	●	●	●	●	●
10 minutes	-	●	●	●	●	●
12 minutes	-	●	●	●	●	●
14 minutes	-	-	●	●	●	●
16 minutes	-	●	●	●	●	●
18 minutes	-	●	●	●	●	●
▶ 20 minutes	-	●	●	●	●	●
22 minutes	-	-	●	●	●	●
24 minutes	-	●	●	●	●	●
26 minutes	-	●	●	●	●	●
28 minutes	-	●	●	●	●	●
30 minutes	-	-	●	●	●	●

DIP Switch #	7	8
Sensitivity		
Minimum	-	-
Medium Low	-	●
Medium High	●	-
▶ Maximum	●	●

● = ON - = OFF
▶ = Factory Presets

OCCUPANCY & VACANCY SENSORS & TIMERS

Commercial Occupancy Sensors Ultrasonic Ceiling Mount

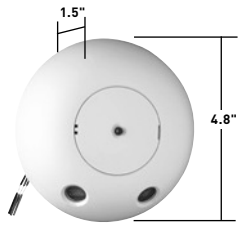

WT605

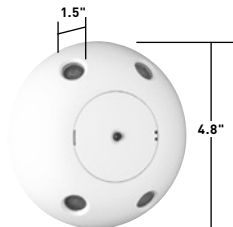

WT1105
WT2205

WT605/WT1105/WT2205 Wiring

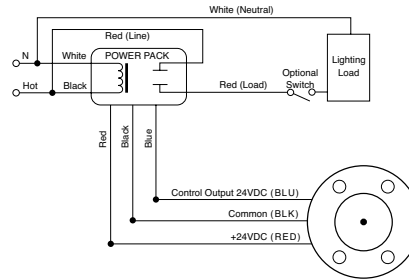

Features

- Advanced signal processing circuitry helps to eliminate false ONs.
- Utilizes advanced, omni-directional (360°), Doppler technology for reliable occupancy detection.
- Angled transmitter and receiver pairs help optimize sensitivity while eliminating unwanted detection from ceiling air movement.
- Digital DIP switch time delay (15 seconds to 30 minutes).
- LED indicates occupancy detection.
- Reliable solid-state construction.
- Temperature and humidity resistant 32 kHz receivers.
- Mounts to ceiling tiles or box.
- Units per power pack: up to 4.
- cULus listed.
- 5-year warranty.

CATALOG NUMBER	DESCRIPTION	RATING	COVERAGE	OVERRIDE AND OUTPUT DISABLE	COLOR
ULTRASONIC CEILING MOUNT SENSORS					
WT605	Ultrasonic Occupancy Sensor	24VDC input, requires Power Pack 27mA	360°, 500 sq. ft. One-sided	Yes	White
WT1105	Ultrasonic Occupancy Sensor	24VDC input, requires Power Pack 30mA	360°, 1100 sq. ft. Two-sided	Yes	White
WT2205	Ultrasonic Occupancy Sensor	24VDC input, requires Power Pack 30mA	360°, 2200 sq. ft. Two-sided	Yes	White

Reference Page N-20 for Power Packs.

Mounting

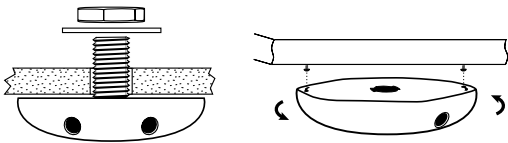

Attached to a vibration-free surface. Mount the sensors with the receivers facing the area of coverage. Note: Place 4' away from supply ducts, 6' from horizontal discharge ducts, and 6" from power packs.

Technical Specifications on Page U-165.

Coverage

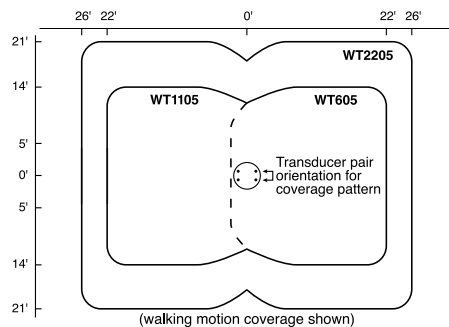

DIP Switch Settings

Time Delay	DIP Switch #					
	1	2	3	4	5	6
15 seconds	●	-	-	-	-	-
2 minutes	-	●	-	-	-	-
4 minutes	-	-	●	-	-	-
6 minutes	-	●	●	-	-	-
8 minutes	-	-	-	●	-	-
10 minutes	-	●	-	-	-	-
12 minutes	-	-	●	●	-	-
14 minutes	-	●	●	●	-	-
*16 minutes	-	-	-	-	●	-
18 minutes	-	●	-	-	●	-
20 minutes	-	-	●	-	-	●
22 minutes	-	●	●	-	●	-
24 minutes	-	-	-	●	●	-
26 minutes	-	●	-	●	●	-
28 minutes	-	-	●	-	-	●
30 minutes	-	●	●	●	●	-
Output Disable	-	-	-	-	-	●
Override	-	-	-	-	-	●

* = factory preset

OCCUPANCY & VACANCY SENSORS & TIMERS

Commercial Occupancy Sensors Dual Technology Ceiling Mount

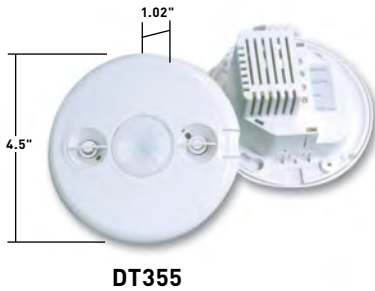

DT355

DT300 Wiring

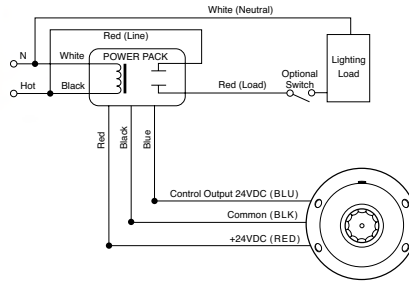

DT355 Wiring

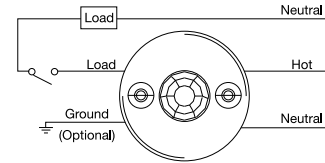

Features

- Advanced control logic based on RISC microcontroller provides:
 - Detection signature processing eliminates false triggers and provides immunity to RFI and EMI.
- Walk-through mode turns lights off three minutes after the area is initially occupied – ideal for brief visits such as mail delivery.
- Simple, one-step setup.
- Ultrasonic diffusion technology spreads coverage to a wider area (patented).
- LEDs indicate occupancy detection.
- Four occupancy logic options give users the ability to customize control to meet application needs.
- Ultrasonic frequency of 40 kHz.
- Time delays: automatic, fixed (5, 10, 15, 20, or 30 minutes), walk-through, test-mode.
- Sensitivity adjustment: reduce sensitivity (for PIR sensitivity); ultrasonic sensitivity is variable with trimpot.
- Multi-level, 360° Fresnel lens for superior occupancy detection.
- Mounting options: ceiling tile; 4 square junction box with double gang mudring.
- Units per power pack: up to 4.
- cULus listed.
- 5-year warranty.

CATALOG NUMBER	DESCRIPTION	RATING	COVERAGE	VERRIDE AND OUTPUT DISABLE	COLOR
LOW-PROFILE CEILING MOUNT SENSORS					
DT300	Dual Technology Occupancy Sensor	24VDC input, requires Power Pack 35mA	360°, 1000 sq. ft. Two-sided	Yes	White
DT355	Dual Technology Occupancy Sensor	0-800W Ballast/Tungsten @ 120V 0-1200W Ballast @ 277V 0-1500W Ballast @ 347V	360°, 1,000 sq. ft.	Yes	White

Reference Page N-20 for Power Packs.

*Does not require power pack.

Coverage

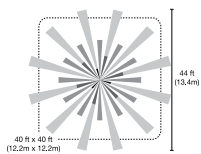

Mounting

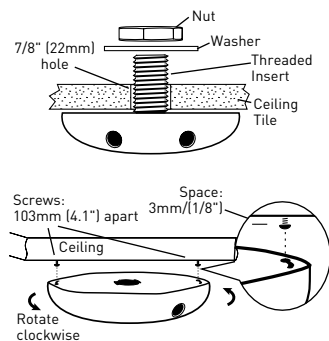

DIP Switch Settings

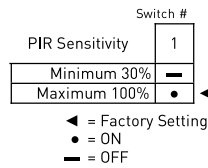

Occupancy Logic	Trigger	Initial Occupancy	Maintain Occupancy	Re-trigger	Switch #	
					2	3
Standard	Both	Either	Either	•	•	•
Option 1	Either	Either	Either	•	•	•
Option 2	PIR	Either	Either	•	•	•
Option 3	Both	Both	Both	•	•	•

Time Delay	Switch #			
	4	5	6	7
15 sec	•	•	•	•
2 min	•	•	•	•
4 min	•	•	•	•
6 min	•	•	•	•
8 min	•	•	•	•
10 min	•	•	•	•
12 min	•	•	•	•
14 min	•	•	•	•
16 min	•	•	•	•
18 min	•	•	•	•
20 min	•	•	•	•
22 min	•	•	•	•
24 min	•	•	•	•
26 min	•	•	•	•
28 min	•	•	•	•
30 min	•	•	•	•

Override	Switch #
	8
On	•
Off	•

Technical Specifications on Page U-166.

OCCUPANCY & VACANCY SENSORS & TIMERS

High Bay Passive Infrared (PIR), Line Voltage Occupancy Sensors



HBP112L7



HB350WL3



HB350WL4

Features

- Integrated occupancy sensor and lens device.
- Multiple mounting options for easy installation.
- Line voltage for direct connection to load.
- Lens choices for mounting between 20-40 feet.
- cULus listed.
- 5-year warranty.
- **HB350WL* Only**
- IP65 rated for wet locations.

CATALOG NUMBER	DESCRIPTION	VOLTAGE	LOAD	COVERAGE
DRY LOCATION HIGH BAY SENSORS				
HBP112L7	High/Low Bay PIR Sensor 120/230/277/347 VAC with lens LOADS: Tungsten, Electronic and Magnetic Ballasts, Fluorescent and LED	120 VAC 50/60 Hz 230 VAC 50/60 Hz 277 VAC 50/60 Hz 347 VAC 50/60 Hz	0-1000VA, 1/4hp 0-1000VA 0-1200VA, 1/4hp 0-1500VA, 1/4hp	Can be mounted 15 ft. to 40 ft. high. 100-foot diameter at 40 ft. Aisleway masking lens included.
WET LOCATION HIGH BAY SENSORS				
HB350WL3	For 20' mounting heights	120/277 VAC, 60 Hz	0-800W Ballast/Tungsten 1/6 HP @ 120V	40 ft. diameter @ 20 ft. mounting height
HB350WL4	For 40' mounting heights		0-1200W Ballast @ 277V	60 ft. diameter @ 40 ft. mounting height

HBP112L7 Lens Coverage

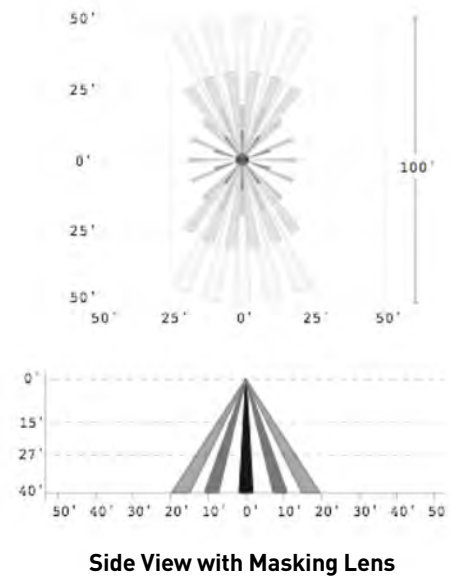
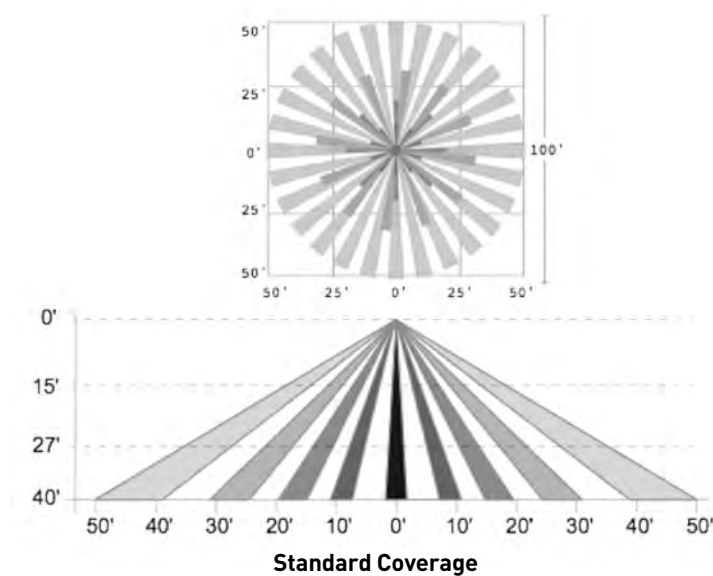

Technical Specifications on Page U-167.

All devices listed on this page conform to NEMA WD-1 and WD-6.

OCCUPANCY & VACANCY SENSORS & TIMERS

Power Packs & Auxiliary Relay Packs



A cost-effective way to power Wattstopper® occupancy sensors.

Wattstopper universal voltage power packs consist of a transformer and high-current relay in one small unit. In addition to a primary high input, power packs have a secondary output of 24VDC, 114mA which provides operating power to sensors. Upon sensing motion or insufficient light, sensors electrically close an internal circuit and send 24VDC back to the power packs or auxiliary relay packs that control lighting systems.

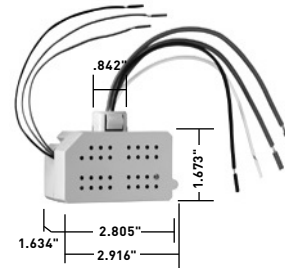

BZ50

Features

- Efficient switching power supply provides optimized current output based on number of sensors.
- Essential to ceiling mount sensor systems.
- Self-contained power supply relay system.
- UL 2043 plenum rated for cost-effective installation.
- UL-rated 94 V0 plastic enclosure.
- 1/2" snap-in nipple attaches to standard electrical enclosures through 1/2" knockouts.
- LED indicates status of relay or low-voltage overcurrent.
- Secondary voltage: 24VDC; Secondary output: 225mA.
- Easy-to-install.
- cULus listed.
- 5-year warranty.

CATALOG NUMBER	DESCRIPTION	INPUT VOLTAGE	LOAD RATINGS			OUTPUT
			BALLAST (A)	INCAN. (A)	MOTOR (HP)	
BZ50	Universal Voltage Power Pack Automatic On/Off	120/277 VAC	20	20	1 (120/250VAC rated)	24 VDC; 225mA with relay connected
BZ150	Universal Voltage Power Pack, Automatic or Manual On/Off, Hold-On, Hold-Off	120/277 VAC	20	20	1 (120/250VAC rated)	24 VDC; 225mA with relay connected
S120/277/347EP	Auxiliary Relay Pack	120/277/347 VAC	20/20/15	13/-/-	1/-/-	-

CATALOG NUMBER	DESCRIPTION	INPUT VOLTAGE	LOAD RATINGS			PLUG LOAD	INPUT
			BALLAST / ELV/ MLV/INC/LED	E-BALLAST CFL	MOTOR (HP)		
BZ200	Universal Voltage Power Pack, Auto On/Off; rated for lighting or plug loads; load On/Off button	120/277 VAC	20	16	1 (120/250VAC rated)	20A	24 VDC; 225mA with relay connected
BZ250	Universal Voltage Power Pack, Auto or Manual On/Off, Hold-On, Hold-Off; rated for lighting or plug loads; load On/Off button	120/277 VAC	20	16	1 (120/250VAC rated)	20A	24 VDC; 225mA with relay connected

Constructed with environmentally friendly materials and is RoHS-compliant.

Installation

Power packs should be installed in accordance with state, local, and national electrical codes. They are designed to attach to electrical enclosures with 1/2 inch knockouts. In plenum ceilings, power packs should be installed in approved electrical enclosures. Most applications require UL listed, 18-22 AWG, 3-conductor, class 2 cable for low-voltage wiring. For plenum rated ceilings use UL listed plenum-approved cables.

For additional Wiring Diagrams, see Pages U-20 and U-21.

Technical Specifications on Page U-168.

J-Box Installation

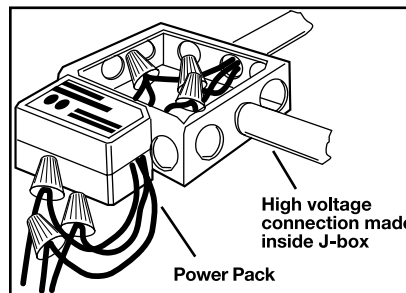

Ceiling Sensor with Power Pack

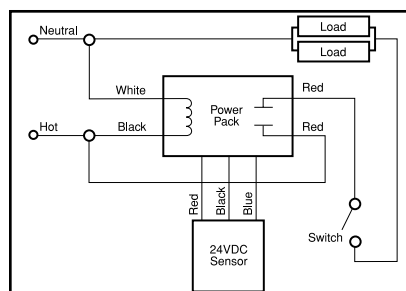

Power Pack Schematics

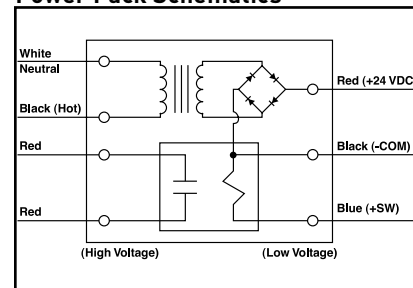

Sensor Schematic with Auxiliary Relay Pack

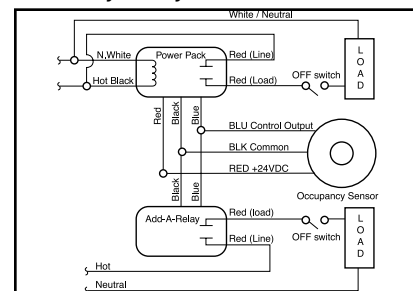

All devices listed on this page conform to NEMA WD-1 and WD-6.

OCCUPANCY & VACANCY SENSORS & TIMERS

Useful Calculations



Examples of savings and payback

EXAMPLE 1

Large office using a CX100 Passive Infrared Sensor

Six 88-watt, 3-lamp fixtures = $0.528 \text{ kW} \times \$0.086/\text{kWh}^* = \$0.04541/\text{hr}$
 Savings = 35 hours per week
 Total hours saved = 1,820 hrs/yr
Annual Savings = \$82.65; 5 Year Savings = \$413.23
 Total estimated cost including power pack: (Product and Labor) = \$140.00
Payback = 20.33 months
ROI = $\$82.65 \div \$140.00 = 59.03\%$

EXAMPLE 2

Individual office using a CI2051 PIR Ceiling Sensor

Three 88-watt, 3-lamp fixtures = $0.264 \text{ kW} \times \$0.086/\text{kWh}^* = \$0.02270/\text{hr}$
 Savings = 50 hours per week
 Total hours saved = 2,600 hrs/yr
Annual Savings = \$59.02; 5 Year Savings = \$295.10
 Total estimated cost: (Product and Labor) = \$54.00
Payback = 10.98 months
ROI = $\$59.02 \div \$54.00 = 109.30\%$

Restroom using a WT1105 Ultrasonic Occupancy Sensor

Four 88-watt, 3-lamp fixtures = $0.352 \text{ kW} \times \$0.086/\text{kWh}^* = \$0.03027/\text{hr}$
 Savings = 75 hours per week
 Total hours saved = 3,900 hrs/yr
Annual Savings = \$118.05; 5 Year Savings = \$590.27
 Total estimated cost: (Product and Labor) = \$160.00
Payback = 16.26 months
ROI = $\$118.05 \div \$160.00 = 73.78\%$

*Based on 2004 US Government National average cost.

Multi-Sensor Installation

For applications requiring more than one sensor, **the load per power pack should not exceed 225mA**.
 Use the following table to calculate the maximum number of sensors per power pack.

CX1051	CI2051/205	CX100	WT605	WT1105/2205	S120/277/347EP	DT300
8mA	11mA	8mA	27mA	30mA	36mA	35mA

Examples:

2 x WT1105 (30mA) = 60mA ✓

This is an acceptable load because it is less than 150mA.

4 x WT1105 (30mA) + 1 x S120/277/347EP(36mA) = 156mA ✗

This is **not** an acceptable load because it is greater than 150mA.

OCCUPANCY & VACANCY SENSORS & TIMERS

Timers

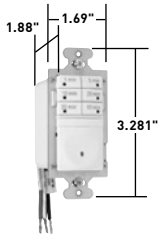

RT50LA



RT2LA

Features

- Five- or seven-button preset time switch.
- Manual ON/OFF.
- Adjustable time delay: 1, 5, 10, 20, 30, 60 minutes for RT50; 10, 20, 40, 60 minutes for RT2.
- Lighted switch for visibility in darkened rooms.
- Controls most types of lighting.
- cULus listed.
- 5-year warranty.
- Load: Incandescent, fluorescent, compact fluorescent (CFL), magnetic low-voltage (MLV) and electronic low-voltage (ELV), 1/6 hp

CATALOG NUMBER	DESCRIPTION	RATING	LOAD	TIME-RUNNING-OUT WARNING	COLOR
DIGITAL TIMERS					
RT50I RT50W RT50B RT50LA	7-Button Digital Timer, Neutral required	0-600W, 1/6 hp @ 120VAC 60 Hz	All	No	Ivory White Black Light Almond
RT2I RT2W RT2BK RT2LA	radiant® 5-Button Timer	0-600W, 1/6 hp @ 120VAC, 60 Hz	All	Visual Countdown	Ivory White Black Light Almond

RT50 Wiring

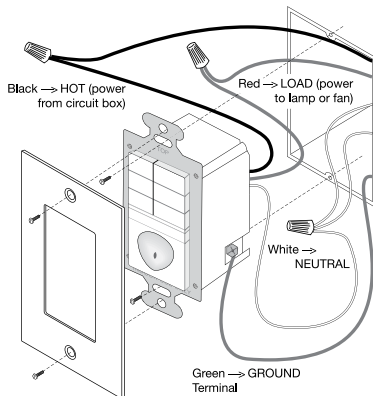

Product Controls

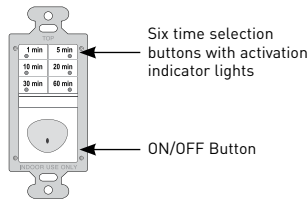

RT50

OCCUPANCY & VACANCY SENSORS & TIMERS



Timers

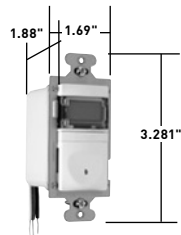

RT100LA

RT100 Wiring

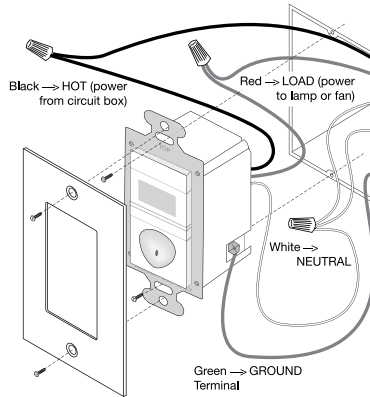

Product Controls

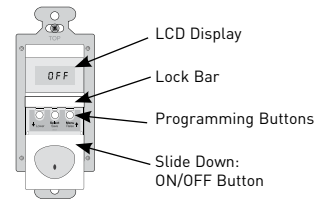

RT100

Features

- Programmable countdown time switch.
- Manual ON/OFF.
- Digital countdown display.
- Adjustable time delay from 5-55 minutes (five-minute increments) to 1-12 hours (15-minute increments).
- Audible beep and visible light flash warnings before automatic-OFF.
- Lighted switch for visibility in darkened rooms.
- Works with most common lighting types.
- cULus listed.
- 5-year warranty.
- Load: Incandescent, fluorescent, compact fluorescent (CFL), magnetic low-voltage (MLV) and electronic low-voltage (ELV), 1/6 hp

CATALOG NUMBER	DESCRIPTION	RATING	LOAD	TIME-RUNNING-OUT WARNING	COLOR
DIGITAL TIMERS					
RT100I				Yes	Ivory
RT100W	12-Button Digital Timer, Neutral required	0-600W @ 120VAC 60 Hz	All	Yes	White
RT100B				Yes	Black
RT100LA				Yes	Light Almond

Features

- Manual or programmed ON/OFF switching.
- Real time clock with day/date calendar.
- Easy to read LED display.
- Programming buttons accessible without removing wall plate.
- Eight programs can be assigned to any day or combination of days of the week.
- Automatically calculates sunrise and sunset times based on latitude and longitude.
- Audible or visual occupant warning before OFF.
- Power failure memory.
- Zero crossing circuitry.
- cULus listed.
- 5-year warranty.
- Load: Incandescent, fluorescent, compact fluorescent (CFL), magnetic low-voltage (MLV) and electronic low-voltage (ELV), 1/6 hp



RT200W
shown with
Optional Plate

CATALOG NUMBER	DESCRIPTION	RATING	LOAD	TIME-RUNNING-OUT WARNING	COLOR
ASTRONOMIC PROGRAMMABLE TIMERS					
RT200I				Yes	Ivory
RT200W	24-Hour Programmable Timer	0-800W @ 120V 0-1200W @ 277V 1/6 hp @ 120/277V	All	Yes	White
RT200B				Yes	Black
RT200LA				Yes	Light Almond

DIMMERS & FAN SPEED CONTROLS



Today's home and business owners want optimum control of their electrical systems. Wattstopper Dimmers & Fan Speed Controls provide that control — along with aesthetics, durability, trouble-free installation and innovative technologies.

Featured Products	 RESIDENTIAL DIMMERS & FAN SPEED CONTROLS 0-4	 RESIDENTIAL & LIGHT COMMERCIAL DIMMERS & FAN SPEED CONTROLS 0-8	 COMMERCIAL DIMMERS & FAN SPEED CONTROLS 0-19
-------------------	--	--	--

Product Selection Guide	0-2
Catalog Numbering System	0-3
Residential Dimmers & Fan Speed Controls	
radiant®	0-4, 0-27
TradeMaster® Toggle	0-15, 0-29









Residential & Light Commercial Dimmers & Fan Speed Controls	
LS Series	0-8, 0-28
DR Series	0-12, 0-27
Wide Slide Series	0-13, 0-29
Toggle Dimmers	0-15, 0-29
Rotary Series	0-18
Commercial Dimmers & Fan Speed Controls	
Titan® Series	0-19-0-30

DIMMERS & FAN SPEED CONTROLS

Product Selection Guide



Energy concerns have created directives in some states for lighting controls in new residential construction and major renovations. In an effort to reduce electrical power consumption, California has mandated one of the most stringent energy codes in the country. California Title 24 requires high efficacy luminaires, vacancy sensors (Section N), or dimmers to be placed in certain areas of the home. Other states are considering adopting similar mandates to answer their own energy concerns. Legrand has an extensive selection of vacancy sensor and dimmer solutions to address this growing industry trend.

 <p>radiant® Dimmers</p> <ul style="list-style-type: none"> • Part of the radiant collection. • Combines ON/OFF paddle switch with separate slider for dimming control. • No lost settings during power outages. <p>PAGES 0-5 – 0-7</p>	 <p>radiant® Multi-Location Dimmers</p> <ul style="list-style-type: none"> • Part of the radiant collection. • Multi-location dimming and fan speed control in up to 10 locations. • Light levels fade elegantly up/down. • Dim from multiple locations. <p>PAGE 0-4</p>
 <p>Wide Slide Dimmers</p> <ul style="list-style-type: none"> • Convenient operation — combines ON/OFF paddle switch with separate slider for dimming control. • Sleek, ergonomic decorator-style matches other decorator-style devices. • Interchangeable face plates allow homeowners to match or accent their decor. <p>PAGE 0-13</p>	 <p>DR Series Rotary Dimmers</p> <ul style="list-style-type: none"> • Illuminated knob shows light level. • Snap-in LED light modules make dimmers easy to find at night. • Available for LED, Incandescent and low voltage lighting. <p>PAGE 0-12</p>
 <p>LS Series Slide Dimmers</p> <ul style="list-style-type: none"> • Smooth, ergonomic operation. • Snap-in LED light modules make dimmers easy to find at night. • Available in both preset and non-preset models. <p>PAGES 0-8 – 0-11</p>	 <p>Rotary Dimmers</p> <ul style="list-style-type: none"> • Models for incandescent and low-voltage lights; preset and illuminated features available. • Simple to operate. • Available in both preset and non-preset models. <p>PAGE 0-18</p>
 <p>Toggle Dimmers</p> <ul style="list-style-type: none"> • Convenient preset dimming control. • Combines ON/OFF toggle with separate preset for dimming control. • Matches appearance of toggle switches. <p>PAGE 0-15</p>  <ul style="list-style-type: none"> • Match appearance of toggle switches. • No loss of settings during power outages. • Illuminated versions available. <p>PAGE 0-17</p>	

DIMMERS & FAN SPEED CONTROLS

Catalog Numbering System



All Dimmers and Fan Speed Controls use an easy-to-understand catalog numbering system:

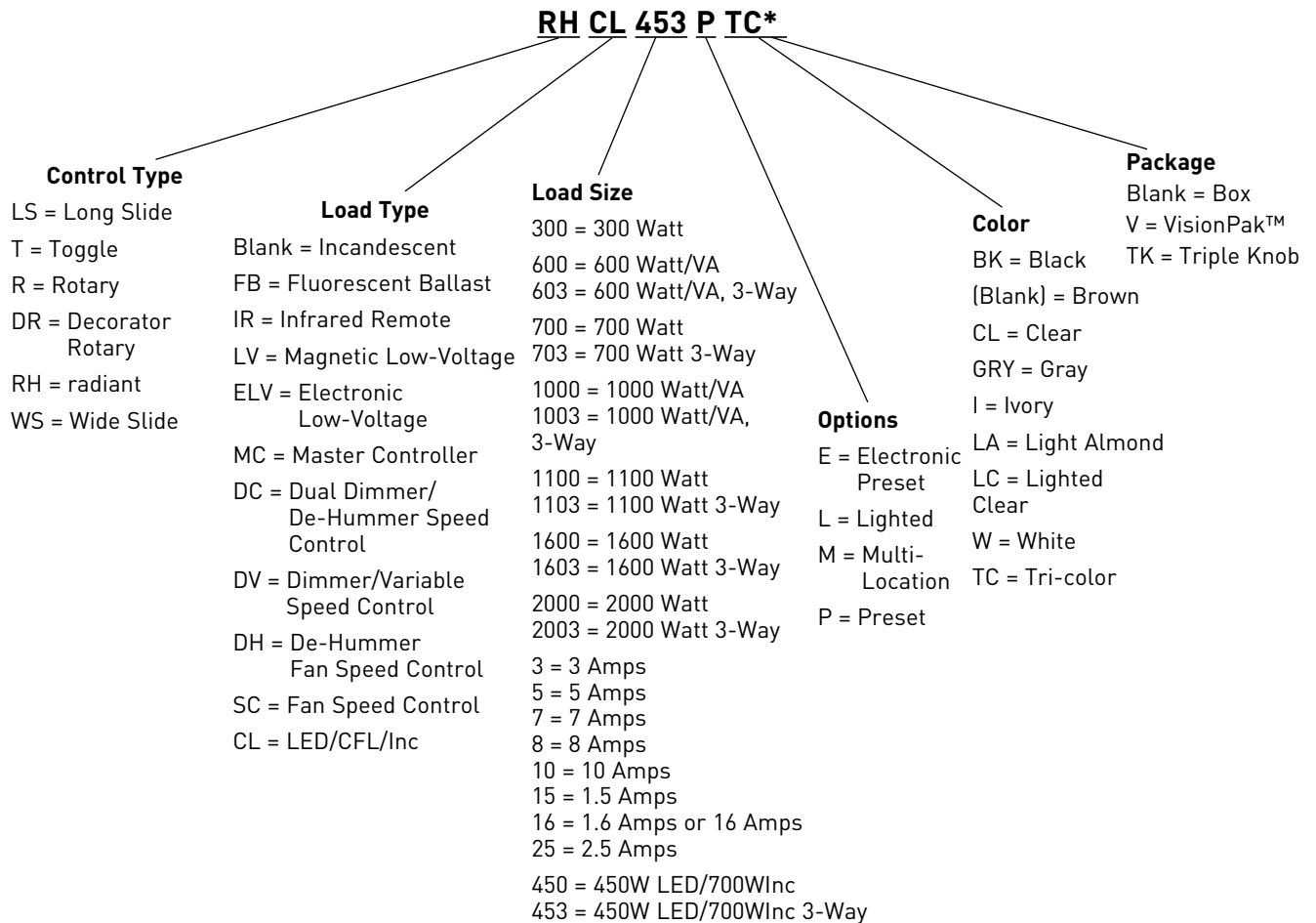

WS703PW = Wide Slide, Incandescent, 700# 3-Way, Preset in White

LS600LA = Decorator-style Long Slide Dimmer, Incandescent, 600W, Light Almond, in a Box

WS53PWV = Wide Slide, Fan Speed Control, 5 Amp, White, in a VisionPak

Many Dimmers & Fan Speed Controls are available boxed or VisionPak™ clam-shell packaging for high-impact merchandising.

Please see the Catalog Numbering System above or specific charts for ordering information.

All devices listed on this page conform to NEMA WD-1 and WD-6. UL Listed and CSA Certified.

RESIDENTIAL DIMMERS & FAN SPEED CONTROLS

the
radiant[®]
collection



radiant[®] Multi-Location Dimmers

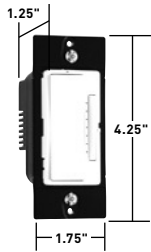

The radiant[®] collection is a step up from the standard with simple, classic options in wiring devices, home automation controls, and screwless wall plates that complement today's homes and hospitality settings.

HCL453PMMW

Features

- Part of the radiant[®] collection.
- Multi-location dimming compatible with 3-way wiring for simple installation
- Can be paired with up to nine remote dimmers (HMRTC/HMRW) for multi-way dimming.

Interchangeable Face Versions

- Package comes with three face colors – Ivory, White, Light Almond (TC).

- White-only option also available.
- Interchangeable faces available in nine colors (sold separately, see below).

CATALOG NUMBER	DESCRIPTION	RATINGS	COLOR
CFL/LED MULTI-LOCATION MASTER DIMMER			
HCL453PMMTC	Single Pole/3-Way with Preset, 3 Interchangeable Face Plates	120V, 60Hz, 25-450W, 700W Incandescent	Ivory, Light Almond, White
HCL453PMMW	Single Pole/3-Way with Preset		White
SINGLE POLE/3-WAY MULTI-LOCATION REMOTE DIMMER, SINGLE POLE/3-WAY, DEHUMMER, PRESET			
HMRTC	Single Pole/3-Way, 3 Interchangeable Face Plates	120V	Ivory, Light Almond, White
HMRW	Single Pole/3-Way		White
MULTI-LOCATION DIMMER INTERCHANGEABLE FACE PLATE, SINGLE POLE/3-WAY			
HMKITAB	Interchangeable Face Plates for Multi-Location Master Dimmers		Antique Brass
HMKITBK			Black
HMKIT			Brown
HMKITDB			Dark Bronze
HMKITGRY			Gray
HMKITI			Ivory
HMKITLA			Light Almond
HMKITNI			Nickel
HMKITW			White
MULTI-LOCATION DE-HUMMER FAN SPEED CONTROL INTERCHANGEABLE FACE PLATE			
HDHKITAB	Interchangeable Face Plates for Multi-Location Master Fan Speed Controls		Antique Brass
HDHKITBK			Black
HDHKIT			Brown
HDHKITDB			Dark Bronze
HDHKITGRY			Gray
HDHKITI			Ivory
HDHKITLA			Light Almond
HDHKITNI			Nickel
HDHKITW			White
MULTI-LOCATION REMOTE DIMMER INTERCHANGEABLE FACE PLATE			
HMRKITAB	Interchangeable Face Plates for Multi-Location Remote Dimmers		Antique Brass
HMRKITBK			Black
HMRKIT			Brown
HMRKITDB			Dark Bronze
HMRKITGRY			Gray
HMRKITI			Ivory
HMRKITLA			Light Almond
HMRKITNI			Nickel
HMRKITW			White

RESIDENTIAL DIMMERS & FAN SPEED CONTROLS

the
radiant®
collection

radiant® Incandescent and Low Voltage Dimmers

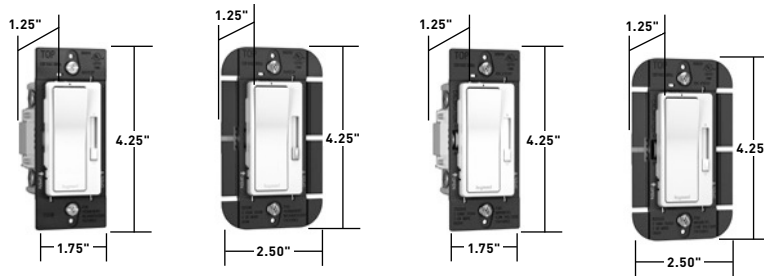

RH703PW

RH1103PLA

RHLV703PW

RHLV1103PLA

Features

- Part of the radiant® collection.
- Convenient operation – combines ON/OFF paddle switch with separate slider for dimming control.
- White LED glows when OFF to make dimmer easy to find in the dark.
- Constant memory returns lights to previous level after a power failure.
- Higher ratings.
- Single pole and 3-way operation.
- Works with standard 3-way switches and wiring.
- Screw-pressure-plate back wire terminals save time, space and money.

RH703P, RHLV703P

- No de-rating.
- No fins to break.

Interchangeable Face Versions

- Package comes with three face colors – Ivory, White, Light Almond (TC).
- White-only option also available.
- Interchangeable faces available in nine colors (sold separately, see below).

CATALOG NUMBER	DESCRIPTION	RATINGS	COLOR
INCANDESCENT SINGLE POLE/3-WAY DIMMERS*			
RH703PW	Incandescent Preset, Single Pole and 3-Way	120V, 700W	White
RH1103PW	Incandescent Preset, Single Pole and 3-Way	120V, 1100W	White
INTERCHANGEABLE FACE INCANDESCENT SINGLE POLE/3-WAY DIMMERS			
RH703PTC	Incandescent Preset, Single Pole and 3-Way Three Interchangeable Face Colors	120V, 700W	Ivory/White/Light Almond
RH1103PTC	Incandescent Preset, Single Pole and 3-Way Three Interchangeable Face Colors	120V, 1100W	Ivory/White/Light Almond
MAGNETIC LOW VOLTAGE PRESET, SINGLE POLE/3-WAY			
RHLV703PTC	Preset, Single Pole/3-Way Three Interchangeable Face Colors	120V, 700VA	Ivory/White/Light Almond
RHLV703PW	Preset, Single Pole/3-Way		White
RHLV1103PTC	Preset, Single Pole/3-Way Three Interchangeable Face Colors	120V, 1100VA	Ivory/White/Light Almond
RHLV1103PW	Preset, Single Pole/3-Way		White
INTERCHANGEABLE FACE COVERS†			
RHKITI RHKITW RHKIT RHKITGRY RHKITBK RHKITLA RHKITAB RHKITDB RHKITNI RHKITRED	Interchangeable Face		Ivory White Brown Gray Black Light Almond Antique Brass Dark Bronze Nickel Red

*Available in VisionPak™ packaging, add "CCV6" to Catalog Number. Example: RH1103PWCCV6.

†Available in VisionPak™ packaging, add "BPCCV6" to Catalog Number. Example: RHKITBPCCV6.

RESIDENTIAL DIMMERS & FAN SPEED CONTROLS

radiant® Tru-Universal and CFL/LED Dimmers

the
radiant®
collection

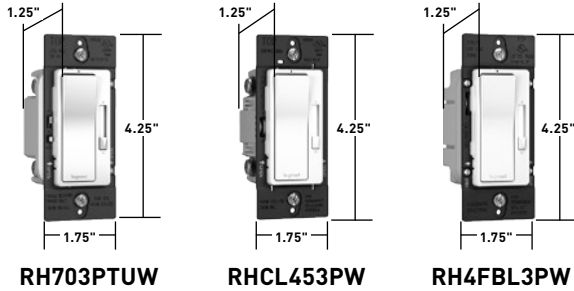

The radiant® collection is a step up from the standard with simple, classic options in wiring devices, home automation controls, and screwless wall plates that complement today's homes and hospitality settings.

Features

radiant® Tru-Universal (RH703PTUW)

- Part of the radiant collection.
- Self-Calibration feature allows users to select lamp type, which then automatically sets the minimum voltage for that lamp, eliminating flickering and poor performance.
- Works with every lamp and load.
- Preset, single pole and 3-way operation.
- Wider slide controller for easier dimming operation.

- Larger paddle switch that's easier to see and use.
- White LED glows when off to make dimmer easy to find in the dark.
- Sleek, modern design that matches today's styles.
- Interchangeable faces — Package comes with three colors: Ivory, White, Light Almond. Other face color kits available separately, see page 0-5.
- NEMA SSL 7A Type 2 Compliant.

radiant CFL/LED Dimmer (RHCL453PW)

- CFL/LED dimmable-bulb compatible (with the exception of 0-10V LED drivers).
- Adjustment dial allows users to adjust the bottom of the dimming range for a wide range of CFL and LED bulbs.
- No derating required in multi-gang applications.

CATALOG NUMBER	DESCRIPTION	RATINGS	COLOR
TRU-UNIVERSAL DIMMER			
RH703PTUTC*	Tru-Universal, Preset, Single-Pole/3-Way Three Interchangeable Face Colors	120 VAC, 60 Hz Incandescent, Halogen & ELV: 700W MLV: 500VA	Ivory/White/Light Almond
RH703PTUW	Tru-Universal, Preset, Single Pole/3-Way	LED/CFL: 450W EFL: 5.5A	White
CFL/LED DIMMERS			
RHCL453PTC	CFL/LED Single Pole and 3-Way, Preset Three Interchangeable Face Colors	120 VAC, 60 Hz, 450W CFL/LED; 700W Incandescent	Ivory/White/Light Almond
RHCL453PW	CFL/LED Single Pole and 3-Way, Preset		White
LED/FLUORESCENT PRESET, SINGLE POLE/3-WAY DIMMERS, 0-10V			
RH4FBL3PTC	Fluorescent Single Pole/3-Way Dimmer with Preset, 3 Interchangeable Face Colors	0-10V0	Ivory/White/Light Almond
RH4FBL3PW	Fluorescent Single Pole/3-Way Dimmer with Preset	0-10V	White

*Available in VisionPak™ packaging, add "CCV6" to Catalog Number. Example: RH703PTUTC6.

RESIDENTIAL DIMMERS & FAN SPEED CONTROLS

radiant® Fluorescent Dimmers & Fan Speed Controls

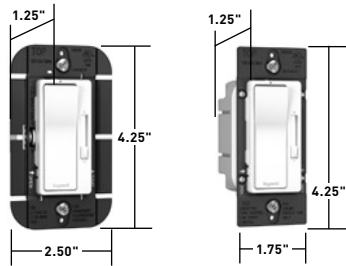
 the
radiant®
 collection

RHFB83PW

RHDH163PW

The radiant® collection is a step up from the standard with simple, classic options in wiring devices, home automation controls, and screwless wall plates that complement today's homes and hospitality settings.

Features

- Part of the radiant® collection.
- Convenient operation – combines ON/OFF paddle switch with separate slider for dimming control.
- White LED glows when OFF to make dimmer easy to find in the dark.
- Constant memory returns lights to previous level after a power failure.
- Higher ratings
- Single pole and 3-way operation.
- Works with standard 3-way switches and wiring.
- Screw-pressure-plate backwire terminals save time, space and money.

RHDH163P

- No de-rating.
- No fins to break.

CATALOG NUMBER	DESCRIPTION	RATINGS	COLOR
FLUORESCENT PRESET, SINGLE POLE/3-WAY DIMMERS*			
RHFB83PTC	Preset, Single Pole/3-Way Three Interchangeable Face Colors	120V, 8A	Ivory/White/Light Almond
RHFB83PW	Preset, Single Pole/3-Way		White
FLUORESCENT PRESET, SINGLE POLE/3-WAY DIMMERS, 0-10V			
RH4FBL3PTC	Fluorescent Single Pole/3-Way Dimmer with Preset, 3 Interchangeable Face Colors	0-10V	Ivory/White/Light Almond
RH4FBL3PW	Fluorescent Single Pole/3-Way Dimmer with Preset	0-10V	White
FAN SPEED CONTROLS, DE-HUMMER**, SINGLE POLE/3-WAY			
RHDH163PTC†	Preset, Single Pole/3-Way Three Interchangeable Face Colors	120V, 1.6A	Ivory/White/Light Almond
RHDH163PW†	Preset, Single Pole/3-Way		White

*For use with Advance MK10 dimming ballasts. See instruction sheet for complete list of compatible ballasts.

**Feature specially designed capacitive circuitry to virtually eliminate fan motor "hum."

†Available in VisionPak™ packaging, add "CCV6" to Catalog Number. Example: RHDH163PTCCCV6.

DE-RATING CHART FOR RADIANT DIMMERS			
CATALOG NUMBER	MAXIMUM LOAD	MULTI-GANG DE-RATING	
		2 GANG	3 GANG
RH703P	700W	700W	700W
RH1103P	1100W	1100W	800W
RHLV703P	700VA	700VA	650VA
RHLV1103P	1100VA	950VA	700VA
RHFB83P	8A	8A	6.5A
RHDH163P	1.6A	1.6A	1.6A

RESIDENTIAL & LIGHT COMMERCIAL DIMMERS & FAN SPEED CONTROLS

LS Series Dimmers

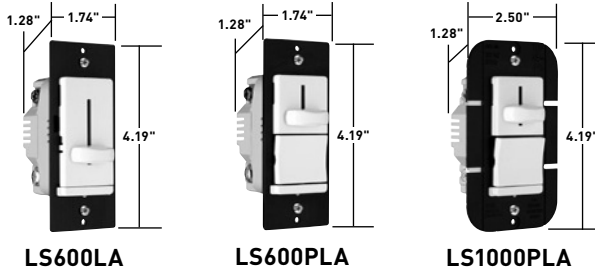

CATALOG NUMBER		DESCRIPTION	RATINGS	COLOR
SINGLE POLE	THREE-WAY			
600W INCANDESCENT SLIDE DIMMERS*				
LS600I		Non-Preset	120V, 600W max.	Ivory
LS600W				White
LS600				Brown
LS600BK				Black
LS600LA				Light Almond
LS600PI	LS603PI	Preset	120V, 600W max.	Ivory
LS600PW	LS603PW			White
LS600P	LS603P			Brown
LS600PBK	LS603PBK			Black
LS600PLA	LS603PLA			Light Almond
1000W INCANDESCENT SLIDE DIMMERS*				
LS1000I		Non-Preset	120V, 1000W max.	Ivory
LS1000W				White
LS1000				Brown
LS1000BK				Black
LS1000LA				Light Almond
LS1000PI	LS1003PI	Preset	120V, 1000W max.	Ivory
LS1000PW	LS1003PW			White
LS1000P	LS1003P			Brown
LS1000PBK	LS1003PBK			Black
LS1000PLA	LS1003PLA			Light Almond
600VA MAGNETIC LOW-VOLTAGE SLIDE DIMMERS**				
LSLV600I		Non-Preset	120V, 600VA max.	Ivory
LSLV600W				White
LSLV600				Brown
LSLV600BK				Black
LSLV600LA				Light Almond
LSLV600PI	LSLV603PI	Preset	120V, 600VA max.	Ivory
LSLV600PW	LSLV603PW			White
LSLV600P	LSLV603P			Brown
LSLV600PBK	LSLV603PBK			Black
LSLV600PLA	LSLV603PLA			Light Almond

*Available in VisionPak™ packaging, add "V" to Catalog Number. Example: LS600IV.

**Available in boxed packaging only.

For wiring diagrams, see Page U-22.

Features

- Ergonomic design and solid, quality feel combine for smooth, easy operation and precise control.
- Electromagnetic and radio-frequency interference protection built in.
- Sleek, sculpted contemporary design. No dirt-catching crevices.
- Tough, impact-resistant thermoplastic housing makes it a perfect choice for new home construction. Matching, unbreakable TradeMaster® wall plate available for all models.
- Preset ON/OFF switch automatically returns controlled lights to preset level without readjusting dimmer setting.
- Exclusive, screw-pressure-plate back wire terminals save time, space and money. Designed for 12 and 14 gauge wire, stranded or solid. No-wire-lead design eliminates wire nuts.
- Superior heat management.
- No de-rating on 600W units.
- Patented Snap-In Light Module (sold separately) transforms the dimmer into an illuminated dimmer. See Page 0-10 for information.

MAX. LOAD RATING	FINS REMOVED	
	ONE SIDE	TWO SIDE
DE-RATING CHART		
LS600, LS603	No De-Rating Required	
LS1000P, LS1003P	900W	750W
LS1000	850W	700W

RESIDENTIAL & LIGHT COMMERCIAL DIMMERS & FAN SPEED CONTROLS

LS Series CFL/LED/Incandescent Dimmers

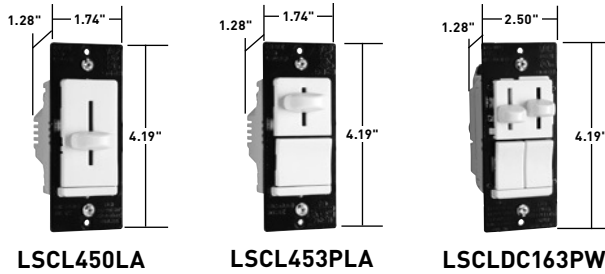

Features

- CFL/LED dimmable bulb compatible (except for 0-10V LED drivers).
- Single pole/3-way versions.
- Unique integrated single pole/3-way dimmer with fan speed control.
- 450W CFL/LED rated.

CATALOG NUMBER	DESCRIPTION	RATINGS	COLOR
CFL/LED SINGLE POLE, NON-PRESET DIMMERS			
LSCL450BK LSCL450 LSCL450I LSCL450LA LSCL450W	Single Pole, Non-Preset	120VAC, 60Hz, 450W	Black Brown Ivory Light Almond White
CFL/LED 3-WAY, PRESET DIMMERS			
LSCL453PBK LSCL453P LSCL453PI LSCL453PLA LSCL453PW	3-Way, Preset	120VAC, 60Hz, 450W	Black Brown Ivory Light Almond White
SINGLE POLE /3-WAY PRESET DIMMER WITH SINGLE POLE/3-WAY 3-SPEED DE-HUMMER FAN CONTROL			
LSCLDC163PBK LSCLDC163P LSCLDC163PI LSCLDC163PLA LSCLDC163PW	Single Pole/3-Way Preset Dimmer With Single Pole/3-Way 3-Speed De-Hummer Fan Control	1.6A, 300W (Fan Control); 120VAC, 60Hz, 450W (Dimmer)	Black Brown Ivory Light Almond White



RESIDENTIAL & LIGHT COMMERCIAL DIMMERS & FAN SPEED CONTROLS

LS Series Dimmers

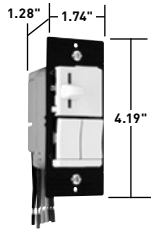

LSDS300PWV



LSDD300W



TM8LMCC8

CATALOG NUMBER	DESCRIPTION	RATINGS		COLOR
		DIMMER	SWITCH	
SINGLE POLE/3-WAY PRESET DIMMERS & SWITCHES				
LSDS300PIV	Single Pole/3-Way Preset Dimmer and Independent Single Pole/3-Way Switch	120V 300W	7A general purpose resistive and ballast, 1/4 hp 900W tungsten	Ivory
LSDS300PWV				White
LSDS300PV				Brown
LSDS300PBKV				Black
LSDS300PLAV				Light Almond
DUAL SLIDE TO OFF SINGLE POLE DIMMERS				
LSDD300I	Dual Slide to OFF Single Pole Dimmers	120V 300W	—	Ivory
LSDD300W				White
LSDD300				Brown
LSDD300BK				Black
LSDD300LA				Light Almond

CATALOG NUMBER	MAXIMUM LOAD	MULTI-GANG DE-RATING	
		2 GANG	3 GANG
DE-RATING CHART			
LSDS300	300W	300W	300W
LSDD300	300W	300W	300W

For wiring diagrams, see Page U-22.

Features

- No tool needed, module snaps-in.
- Lights when OFF.
- Uses energy-efficient 1/4 watt LED light.
- LED light will not generate heat and will last on average 47 years.

CATALOG NUMBER	RATING		COLOR
	A.	VAC	
SNAP-IN LIGHT MODULE			
TM8LMCC8	15	120/125	Clear

CATALOG NUMBER	DESCRIPTION	COLOR
ACCESSORIES FOR		
LRKIV	Replacement Knobs for LS Series Dual Slides	Ivory
LRKWV		White
LRKV		Brown
LRKBKV		Black
LRKLAV		Light Almond
LLRKIV	Large Replacement Knobs for LS Series Single Slides	Ivory
LLRKWV		White
LLRKV		Brown
LLRKBKV		Black
LLRKLAV		Light Almond

DIMMERS & FAN SPEED CONTROLS

RESIDENTIAL & LIGHT COMMERCIAL DIMMERS & FAN SPEED CONTROLS



LS Series Fan Speed Controls

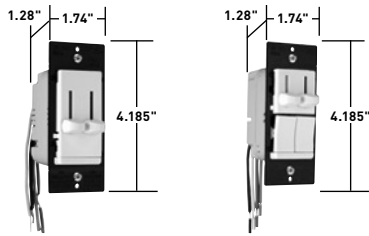

LSDC16LAV

LSDC163PLAV

Features

- Tough impact-resistant thermoplastic housing.
- Power-failure memory.
- Superior heat management: no time wasting break off tabs.
- Exclusive, screw-pressure-plate back wire terminals eliminates wire nuts.
- Can be used with patented Snap-In Light Module (sold separately).

CATALOG NUMBER	DESCRIPTION	RATINGS	COLOR
SLIDE FAN SPEED CONTROLS*			
LSSC5I LSSC5W LSSC5 LSSC5BK LSSC5LA	Non-Preset, Single Pole, Adjustable Trim	5A	Ivory White Brown Black Light Almond
LSSC5PI LSSC5PW LSSC5P LSSC5PBK LSSC5PLA	Preset, Single Pole, Adjustable Trim	5A	Ivory White Brown Black Light Almond
SLIDE DE-HUMMER CONTROLS**			
LSDH16IV LSDH16WV LSDH16V LSDH16BKV LSDH16LAV	Non-Preset, 4-Speed Fan Control	1.6A	Ivory White Brown Black Light Almond
DUAL CONTROL SLIDES**			
LSDC16IV LSDC16WV LSDC16V LSDC16BKV LSDC16LAV	Non-Preset, 3-Speed De-Hummer Fan Control With Single Pole Dimmer	1.6A/300W	Ivory White Brown Black Light Almond
LSDC163PIV LSDC163PWV LSDC163PV LSDC163PBKV LSDC163PLAV	Preset, Single Pole/3-Way 3-Speed De-Hummer Fan Control with Single Pole/3 Way Dimmer	1.6A/300W	Ivory White Brown Black Light Almond
LSDV25IV LSDV25WV LSDV25V LSDV25BKV LSDV25LAV	Non-Preset, Variable Speed Fan Control With Single Pole Dimmer	2.5A/300W	Ivory White Brown Black Light Almond
SINGLE POLE /3-WAY PRESET DIMMER WITH SINGLE POLE/3-WAY 3-SPEED DE-HUMMER FAN CONTROL			
LSCLDC163PBK LSCLDC163P LSCLDC163PI LSCLDC163PLA LSCLDC163PW	Single Pole/3-Way Preset Dimmer With Single Pole/3-Way 3-Speed De-Hummer Fan Control	1.6A, 300W (Fan Control); 120VAC, 60Hz, 450W (Dimmer)	Black Brown Ivory Light Almond White

*Available in VisionPak™ packaging, add "V" to Catalog Number. Example: LSSC5IV.

**Available in VisionPak™ only.

Feature specially designed capacitive circuitry to virtually eliminate fan motor "hum."

For wiring diagrams, see Page U-22.

All devices listed on this page conform to NEMA WD-1 and WD-6. UL Listed and CSA Certified.



RESIDENTIAL & LIGHT COMMERCIAL DIMMERS & FAN SPEED CONTROLS

DR Series Dimmers & Fan Speed Controls

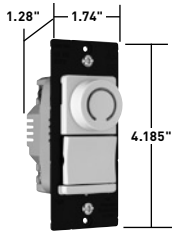

DR703PLAV

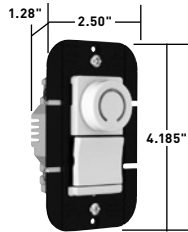

DR1103PW



Illuminated knob indicates light level.

Features

- Matches P&S Deco Combo devices.
- Accepts Snap-In Light Module (sold separately) to convert devices into illuminated-type in moments; makes devices easy to find in the dark. See Page O-10.
- Screw-pressure-plate backwiring speeds installation and ensures solid, high-quality electrical connections. Also supports traditional, wire-loop side wiring.
- Heavy-gauge black anodized aluminum strap provides superior heat management and structural strength for mounting against wall surfaces.
- Slim design leaves more room in the box and makes installation faster and easier.
- Higher ratings of 700 and 1100 watts.
- No de-rating of 700 watt devices.
- Single pole and 3-way in same device.

CATALOG NUMBER	DESCRIPTION	RATINGS	COLOR
INCANDESCENT PRESET DIMMERS			
DR703PIV	Single Pole/3-Way Dimmer with Pilot Light	120V, 700W	Ivory
DR703PWV			White
DR703PV			Brown
DR703PBKV			Black
DR703PLAV			Light Almond
DR1103PIV	Single Pole/3-Way Dimmer with Pilot Light	120V, 1100W	Ivory
DR1103PWV			White
DR1103PV			Brown
DR1103PBKV			Black
DR1103PLAV			Light Almond
CFL/LED 3-WAY PRESET DIMMERS			
DRCL453PBK	3-Way, Preset	120VAC, 60Hz, 450W	Black
DRCL453P			Brown
DRCL453PI			Ivory
DRCL453PLA			Light Almond
DRCL453PW			White
MAGNETIC LOW-VOLTAGE DIMMERS			
DRLV703PI	Single Pole/3-Way Dimmer with Pilot Light	120V, 700VA	Ivory
DRLV703PW			White
DRLV703P			Brown
DRLV703PBK			Black
DRLV703PLA			Light Almond
DRLV1103PI	Single Pole/3-Way Dimmer with Pilot Light	120V, 1100VA	Ivory
DRLV1103PW			White
DRLV1103P			Brown
DRLV1103PBK			Black
DRLV1103PLA			Light Almond

CATALOG NUMBER	DESCRIPTION	RATINGS	COLOR
CONTINUOUSLY VARIABLE PRESET FAN SPEED CONTROLS			
DRSC53PIV	Single Pole/3-Way Fan Speed Control	120V, 5A	Ivory
DRSC53PWV			White
DRSC53PV			Brown
DRSC53PBKV			Black
DRSC53PLAV			Light Almond
3-SPEED DE-HUMMER* PRESET FAN SPEED CONTROLS			
DRDH163PIV	Single Pole/3-Way Fan Speed Control with back-lit speed indication	120V, 1.6A	Ivory
DRDH163PWV			White
DRDH163PV			Brown
DRDH163PBKV			Black
DRDH163PLAV			Light Almond

CATALOG NUMBER	MAXIMUM LOAD	MULTI-GANG DE-RATING	
		2 GANG	3 GANG
DE-RATING CHART FOR DR SERIES			
DR703	No De-Rating Required		
DR1103	1100W	900W	750W

Available in VisionPak™ only.

* Feature specially designed capacitive circuitry to virtually eliminate fan motor "hum."

DIMMERS & FAN SPEED CONTROLS

RESIDENTIAL & LIGHT COMMERCIAL DIMMERS & FAN SPEED CONTROLS



Wide Slide Series

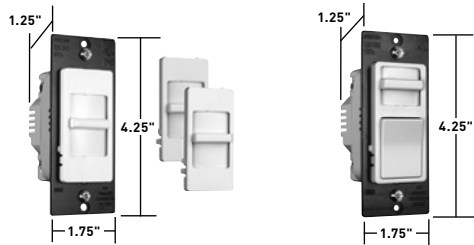

WS700TC
WSLV700TC

Preset Models

Shown with the Three Interchangeable Faces
All 1100W versions are 2.50" W

Features

- Convenient operation – combines ON/OFF paddle switch with separate slider for dimming control.
- Constant memory returns lights to previous level after a power failure.
- Sleek, ergonomic decorator-style matches other decorator-style devices.
- Higher ratings.
- Single pole and 3-way operation.
- Screw-pressure-plate back wire terminals save time, space and money.
- 700W maximum rated dimmers can be ganged without de-rating.
- Package comes with three face colors – Ivory, White, Light Almond (TC).
- White only option also available (W).
- Interchangeable faces available in four colors (sold separately, see below).

CATALOG NUMBER	DESCRIPTION	RATINGS	COLOR
INTERCHANGEABLE FACE INCANDESCENT DIMMERS			
WS700TC* WS700W	Single Pole, Slide to OFF, 3 Face Colors White Face Only	120V, 700W 120V, 700W	Ivory/White/Lt. Almond White
WS703PTC* WS703PW	Preset, Single Pole/3-Way, 3 Face Colors White Face Only	120V, 700W 120V, 700W	Ivory/White/Lt. Almond White
WS1100TC* WS1100W	Single Pole, Slide to OFF, 3 Face Colors White Face Only	120V, 1100W 120V, 1100W	Ivory/White/Lt. Almond White
WS1103PTC* WS1103PW	Preset, Single Pole/3-Way, 3 Face Colors White Face Only	120V, 1100W 120V, 1100W	Ivory/White/Lt. Almond White
INTERCHANGEABLE FACE MAGNETIC LOW-VOLTAGE DIMMERS			
WSLV700TC* WSLV700W	Single Pole, Slide to OFF, 3 Face Colors White Face Only	120V, 700VA 120V, 700VA	Ivory/White/Lt. Almond White
WSLV703PTC* WSLV703PW	Preset, Single Pole/3-Way, 3 Face Colors White Face Only	120V, 700VA 120V, 700VA	Ivory/White/Lt. Almond White
INTERCHANGEABLE FACE FAN SPEED CONTROLS			
WSSC53PTC* WSSC53PW	Preset, Variable Speed, 3 Face Colors White Face Only	120V, 5A 120V, 5A	Ivory/White/Lt. Almond White
INTERCHANGEABLE FACE COVERS**			
WSKITI WSKIT WSKITBK WSKITLA	Wide Slide Interchangeable Face		Ivory Brown Black Light Almond
WSKITPI WSKITP WSKITPBK WSKITPLA WSKITPRED WSKITPGRY	Preset Wide Slide Interchangeable Face		Ivory Brown Black Light Almond Red Gray

*Available in VisionPak™ packaging, add "CCV6" to Catalog Number. Example: WS700TCCC6.
**Available in VisionPak™ packaging, add "BPCC6" to Catalog Number. Example: WSKITIBPCC6.

MAX. LOAD RATING	FINS REMOVED	
	ONE SIDE	TWO SIDE
DE-RATING CHART		
1000W	800W	700W
1000VA	800VA	700VA

Note: Each side removed reduces plate size by 3/8".



RESIDENTIAL & LIGHT COMMERCIAL DIMMERS & FAN SPEED CONTROLS

Wide Slide Series CFL/LED/Incandescent Dimmers

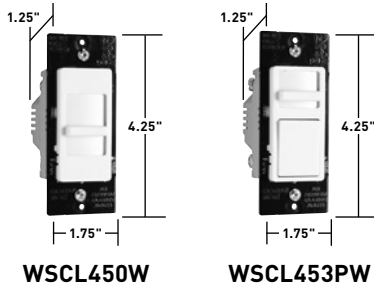
WSCL450W
WSCL453PW

Features

- Convenient operation – combines ON/OFF paddle switch with separate slider for dimming control.
- Constant memory returns lights to previous level after a power failure.
- Sleek, ergonomic decorator-style matches other decorator-style devices.
- Higher ratings.
- Single pole and 3-way operation.
- Screw-pressure-plate back wire terminals save time, space and money.
- 450W maximum rated dimmers can be ganged without de-rating.
- Designed for CFL/LED and incandescent dimmers.
- Package comes with three face colors – Ivory, White, Light Almond (TC).
- White only option also available (W).
- Interchangeable faces available in four colors (sold separately, see below).

CATALOG NUMBER	DESCRIPTION	RATINGS	COLOR
SINGLE POLE, NON-PRESET CFL/LED SLIDE DIMMERS			
WSCL450TC	Single Pole, Non-Preset, 3 Interchangeable Face Plates	120VAC, 60Hz, 450W	Ivory, Light Almond, White
WSCL450W	Single Pole, Non-Preset		White
SINGLE POLE/3-WAY, PRESET CFL/LED SLIDE DIMMERS			
WSCL453PTC	Single Pole/3-Way, Preset, 3 Interchangeable Face Plates	120VAC, 60Hz, 450W	Ivory, Light Almond, White
WSCL453PW	Single Pole/3-Way, Preset		White
SINGLE POLE/3-WAY, NON-PRESET CFL/LED SLIDE DIMMERS			
WSCL453TC	Single Pole/3-Way, Non-Preset, 3 Interchangeable Face Plates	120VAC, 60Hz, 450W	Ivory, Light Almond, White
WSCL453W	Single Pole/3-Way, Non-Preset		White
FLUORESCENT SINGLE POLE/3-WAY DIMMER WITH PRESET			
WS4FBL3PTC	Fluorescent Single Pole/3-Way Dimmer with Preset, 3 Interchangeable Face Plates	0-10V	Ivory, Light Almond, White
WS4FBL3PW	Fluorescent Single Pole/3-Way Dimmer with Preset		White

RESIDENTIAL DIMMERS & FAN SPEED CONTROLS

TradeMaster® Toggle Dimmers



TDCL453PW

Trademaster® Toggle Dimmers

- A. Matches appearance** of standard P&S toggle switch.
- B. More versatile than standard toggle dimmers.**
Provides easy ON/OFF. Separate preset allows convenient dimming control.
- No de-rating required** in multi-gang applications (700W).
- Uses conventional 3-way wiring** when used in conjunction with a 3-way switch.
- Returns lights to previous level** after power failure.

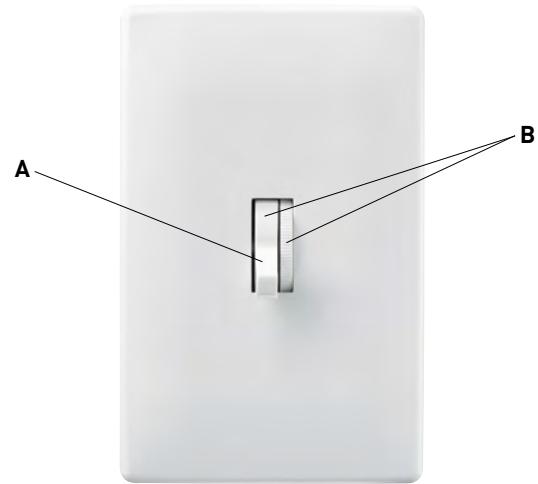

TDCL453PW

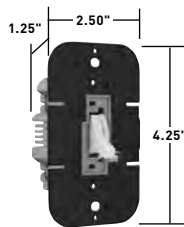

TD1103PW

700W versions are 1.75" W

CATALOG NUMBER	DESCRIPTION	RATINGS	COLOR
INCANDESCENT SINGLE POLE/3-WAY DIMMERS			
TD703PI*	Preset, Single Pole/3-Way	120V, 700W	Ivory
TD703PW*			White
TD703P			Brown
TD703PBK			Black
TD703PLA*			Light Almond
TD1103PI*	Preset, Single Pole/3-Way	120V, 1100W	Ivory
TD1103PW*			White
TD1103P			Brown
TD1103PBK			Black
TD1103PLA*			Light Almond
CFL/LED 3-WAY, PRESET DIMMERS			
TDCL453PBK	3-Way, Preset	120VAC, 60Hz, 450W	Black
TDCL453P			Brown
TDCL453PI			Ivory
TDCL453PLA			Light Almond
TDCL453PW			White

*Available in VisionPak™ packaging, add "CCV6" to Catalog Number. Example: TD703PICCV6.

MAX. LOAD RATING	FINS REMOVED	
	ONE SIDE	TWO SIDE
DE-RATING CHART		
1000W	800W	700W

Note: Each side removed reduces plate size by 3/8".

For wiring diagrams, see Page O-16.



RESIDENTIAL DIMMERS & FAN SPEED CONTROLS

TradeMaster® Toggle Dimmers & Fan Speed Controls

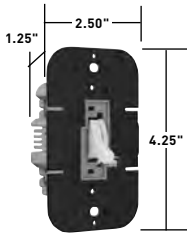
TDLV1103PW

700VA versions are 1.75" W

CATALOG NUMBER	DESCRIPTION	RATINGS	COLOR
MAGNETIC LOW-VOLTAGE SINGLE POLE/3-WAY DIMMERS			
TDLV703PI	Preset, Single Pole/3-Way	120V, 700VA	Ivory
TDLV703PW			White
TDLV703P			Brown
TDLV703PBK			Black
TDLV703PLA			Light Almond
TDLV1103PI	Preset, Single Pole/3-Way	120V, 1100VA	Ivory
TDLV1103PW			White
TDLV1103P			Brown
TDLV1103PBK			Black
TDLV1103PLA			Light Almond
FLUORESCENT SINGLE POLE/3-WAY DIMMERS*			
TDFB83PI	Two Wire Fluorescent Single Pole/3-Way	120V, 8A	Ivory
TDFB83PW			White
TDFB83P			Brown
TDFB83PBK			Black
TDFB83PLA			Light Almond
DE-HUMMER** FAN SPEED CONTROLS			
TDDH163PI	De-Hummer Fan Speed Control	120V, 1.6A	Ivory
TDDH163PW			White
TDDH163P			Brown
TDDH163PBK			Black
TDDH163PLA			Light Almond

* For use with Advance MK10 dimming ballasts.
See instruction sheet for complete list of compatible ballasts.

**Feature specially designed capacitive circuitry to virtually eliminate fan motor "hum."

Wiring Diagrams

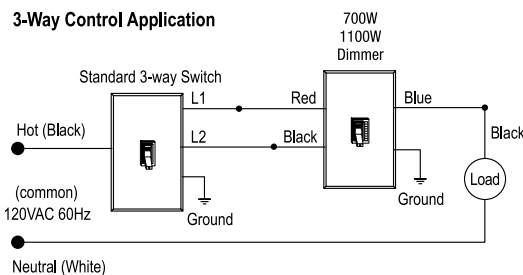
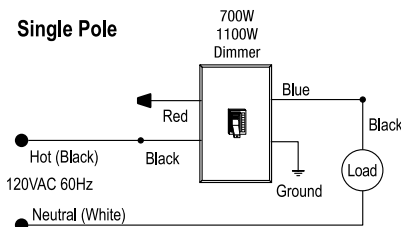

RESIDENTIAL DIMMERS & FAN SPEED CONTROLS

TradeMaster® Toggle Dimmers & Fan Speed Controls

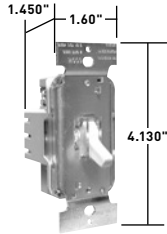

**T600I
TSC5I**

Features

- Tough impact-resistant thermoplastic housing.
- Power-failure memory.
- Superior heat management: no time wasting break off tabs.
- Exclusive, screw-pressure-plate back wire terminals eliminates wire nuts.

CATALOG NUMBER		DESCRIPTION	RATINGS	COLOR
SINGLE POLE	THREE-WAY			
600W INCANDESCENT TOGGLE DIMMERS				
T600I*	T603I**	Non-Preset	120V 600W	Ivory
T600W*	T603W**			White
T600*	T603**			Brown
T600LA*	T603LA**			Light Almond
600W INCANDESCENT – LIGHTED TOGGLE DIMMERS*				
T600LI	T603LI	Non-Preset	120V 600W	Ivory
T600LW	T603LW			White
T600LLA	T603LLA			Light Almond
1000W INCANDESCENT TOGGLE DIMMERS				
T1000I*	T1003I**	Non-Preset	120V 1000W	Ivory
T1000W*	T1003W**			White
T1000*	T1003**			Brown
T1000LA*	T1003LA**			Light Almond
1000W INCANDESCENT – LIGHTED TOGGLE DIMMERS**				
T1000LI	T1003LI	Non-Preset	120V 1000W	Ivory
T1000LW	T1003LW			White
T1000LLA	T1003LLA			Light Almond
600VA LOW-VOLTAGE MAGNETIC TOGGLE DIMMERS*				
TLV600I	TLV603I	Non-Preset	120V 600VA	Ivory
TLV600W	TLV603W			White
TLV600LA	TLV603LA			Light Almond
1000VA LOW-VOLTAGE MAGNETIC TOGGLE DIMMERS**				
TLV1000I	TLV1003I	Non-Preset	120V 1000VA	Ivory
TLV1000W	TLV1003W			White
TLV1000LA	TLV1003LA			Light Almond
TOGGLE FAN SPEED CONTROLS*				
TSC5I	—	Non-Preset, Adjustable Trim	120V 5A	Ivory
TSC5W	—			White
TSC5LA	—			Light Almond

* Available in VisionPak™ packaging, add "V" to Catalog Number. Example: T600LAV.

**Available in boxed packaging only.

MAX. LOAD RATING	GANG REDUCTION	
	2 CONTROLS	3+ CONTROLS
DE-RATING CHART		
5A	4A	3A

MAX. LOAD RATING	GANG REDUCTION	
	2 DIMMERS	3+ DIMMERS
DE-RATING CHART		
600W	500W	400W
1000W	700W	650W



RESIDENTIAL DIMMERS & FAN SPEED CONTROLS

Rotary R Series Dimmers



R600PWV



R1000WV

Features

- Slimmer design – the trimmest rotary dimmers, 1/4" less depth than the leading competitor's models.
- Easy-to-grip knob with soft, contemporary curves goes with any décor. Interchangeable with older-style knobs.
- Excellent RFI/EMI filtering performance – won't impact sensitive electronic devices.
- Pre-stripped leads speed termination.
- No de-rating of 600 watt models in multi-gang applications.
- Leaves more room in the box for faster, easier installation.
- Makes small adjustments in lighting levels easier.
- Illuminated models are easy to find in the dark.

CATALOG NUMBER		DESCRIPTION	RATINGS	COLOR
SINGLE POLE	THREE-WAY			
600W INCANDESCENT RFI ROTARY DIMMERS				
R600IV		Non-Preset	120V 600W	Ivory
R600WV				White
R600LAV				Light Almond
R600PIV	R603PIV	Preset	120V 600W	Ivory
R600PWV	R603PWV			White
R600PLAV	R603PLAV			Light Almond
1000W INCANDESCENT RFI ROTARY DIMMERS				
R1000IV		Non-Preset	120V 1000W	Ivory
R1000WV				White
R1000LAV				Light Almond
R1000PIV	R1003PIV	Preset	120V 1000W	Ivory
R1000PWV	R1003PWV			White
R1000PLAV	R1003PLAV			Light Almond

Available in VisionPak™ only.

Rotary Dimmer 3-Way Wiring Diagram

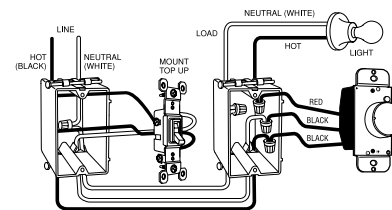

DIMMERS & FAN SPEED CONTROLS

CATALOG NUMBER	DESCRIPTION	COLOR
ROTARY REPLACEMENT KNOBS		
RRKIV	Plain Replacement Knob	Ivory
RRKWV		White
RRKLAV		Light Almond
RRKCLGV	Deluxe Replacement Knob	Clear
RRKIGV		Ivory
RRKWGV		White
RRKLAGV		Light Almond

CATALOG NUMBER	MAXIMUM LOAD	MULTI-GANG DE-RATING	
		2 GANG	3 GANG
DE-RATING CHART FOR R SERIES			
R600, R600P	600W	No De-Rating Required	
R1000	1000W	750W	700W
R1000P	1000W	900W	800W
R1003P	1000W	900W	800W

COMMERCIAL DIMMERS & FAN SPEED CONTROLS

Titan® Series Dimmers & Fan Speed Controls



CD703PW

Titan Commercial Dimmers

- A. Exclusive labeling system has a built-in label holder** enabling instant circuit identification; looks clean and professional.
- B. Included end-caps and spacers** screw directly to heat sinks; center plate snaps easily on and off.
- C. Enclosed slider** helps prevent dust and dirt contamination.
- D. Exclusive adjustable limit control in incandescent dimmers saves energy** and extends bulb life — reduces maximum output by up to 10 percent.
- E. Air-gap switch**
- F. Improved heat management** enables superior load ratings.

Included screwless wall plate components make it easy to assemble a custom multi-gang wall plate in any configuration — saving money and time.

Preset models feature large ON/OFF button and single pole/three-way functionality.

High-reliability design with built-in surge and static protection plus oversize output devices to stand up to abuse.

Power-failure memory retains presets through power outages.

Widest choice of amperage ratings with minimal or no de-rating for faster job planning.

A complete solution for easy, economical multi-gang installations.

The Wattstopper Titan® Series dimmers have key features designed to increase installer productivity. Each comes with all the screwless wall plate components necessary for single gang or multi-gang installations. No need to order any additional components such as long-lead time custom wall plates to finish the job. Complete the installation with everything right out of the box, increasing productivity by finishing up in one visit instead of several.

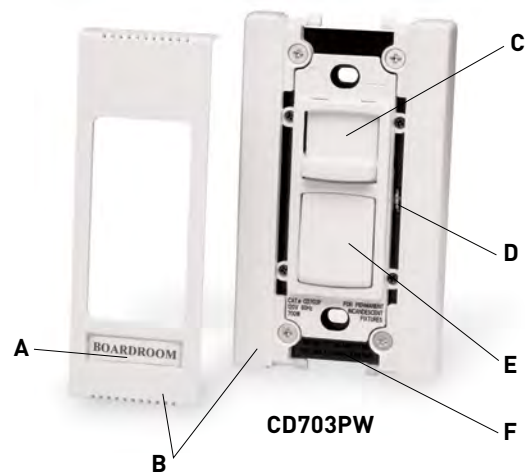

CDADAPTORKITW



Adaptor kit enables matching installation of standard P&S Decorator-Style Devices – outlets, switches, GFCIs and more. See page 0-21 for ordering information.

COMMERCIAL DIMMERS & FAN SPEED CONTROLS

Titan® Series Incandescent Dimmers

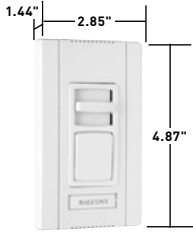

CD703PW - Narrow

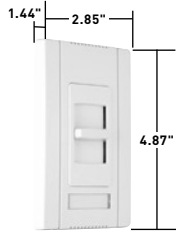

CD1100W - Narrow

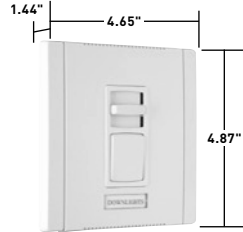

CD1603PW - Wide

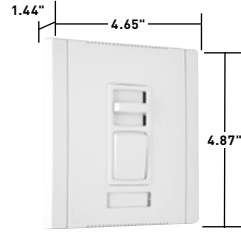

CD2003PW - Wide

CATALOG NUMBER	DESCRIPTION	RATINGS	NARROW OR WIDE	COLOR
INCANDESCENT				
CD700I CD700W CD700 CD700GRY CD700BK CD700LA	Single Pole, Slide-to-OFF	120V, 700W	Narrow	Ivory White Brown Gray Black Light Almond
CD703PI CD703PW CD703P CD703PGRY CD703PBK CD703PLA	Single Pole/3-Way, Preset	120V, 700W	Narrow	Ivory White Brown Gray Black Light Almond
CD1100I CD1100W CD1100 CD1100GRY CD1100BK CD1100LA	Single Pole, Slide-to-OFF	120V, 1100W	Narrow	Ivory White Brown Gray Black Light Almond
CD1103PI CD1103PW CD1103P CD1103PGRY CD1103PBK CD1103PLA	Single Pole/3-Way, Preset	120V, 1100W	Narrow	Ivory White Brown Gray Black Light Almond
CD1600I CD1600W CD1600 CD1600GRY CD1600BK CD1600LA	Single Pole, Slide-to-OFF	120V, 1600W	Wide	Ivory White Brown Gray Black Light Almond
CD1603PI CD1603PW CD1603P CD1603PGRY CD1603PBK CD1603PLA	Single Pole/3-Way, Preset	120V, 1600W	Wide	Ivory White Brown Gray Black Light Almond
CD2000I CD2000W CD2000 CD2000GRY CD2000BK CD2000LA	Single Pole, Slide-to-OFF	120V, 2000W	Wide	Ivory White Brown Gray Black Light Almond
CD2003PI CD2003PW CD2003P CD2003PGRY CD2003PBK CD2003PLA	Single Pole/3-Way, Preset	120V, 2000W	Wide	Ivory White Brown Gray Black Light Almond

Features

- Field configurable wall plate system.
- Labeling system.
- Adjustable top end output voltage.
- Shipped with protective film.
- Rugged construction.
- Superior ratings with a minimum of de-rating when ganged.
- Simple to plan the rough-in.
- Available in single pole slide-to-OFF and single pole/3-way preset models.
- Attractive European styling.
- Eye-catching packaging.
- Exclusive adaptor kit to install other decorator-style opening devices under the Titan® wall plate system. (See Page O-21.)
- Blank center plate included.

DIMMERS & FAN SPEED CONTROLS

For technical specifications, de-rating, and rough-in box charts, see U-170.

All devices listed on this page conform to NEMA WD-1 and WD-6. UL Listed and CSA Certified.

COMMERCIAL DIMMERS & FAN SPEED CONTROLS

Titan® Series Magnetic Low-Voltage Dimmers & Adaptor Kit



CDLV700W - Narrow

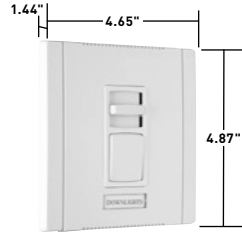

CDLV1103PW - Wide

CATALOG NUMBER	DESCRIPTION	RATINGS	NARROW OR WIDE	COLOR
MAGNETIC LOW-VOLTAGE				
CDLV700I CDLV700W CDLV700 CDLV700GRY CDLV700BK CDLV700LA	Single Pole, Slide-to-OFF	120V, 700W	Narrow	Ivory White Brown Gray Black Light Almond
CDLV703PI CDLV703PW CDLV703P CDLV703PGRY CDLV703PBK CDLV703PLA	Single Pole/3-Way, Preset	120V, 700W	Narrow	Ivory White Brown Gray Black Light Almond
CDLV1100I CDLV1100W CDLV1100 CDLV1100GRY CDLV1100BK CDLV1100LA	Single Pole, Slide-to-OFF	120V, 1100W	Narrow	Ivory White Brown Gray Black Light Almond
CDLV1103PI CDLV1103PW CDLV1103P CDLV1103PGRY CDLV1103PBK CDLV1103PLA	Single Pole/3-Way, Preset	120V, 1100W	Narrow	Ivory White Brown Gray Black Light Almond
CDLV1600I CDLV1600W CDLV1600 CDLV1600GRY CDLV1600BK CDLV1600LA	Single Pole, Slide-to-OFF	120V, 1600W	Wide	Ivory White Brown Gray Black Light Almond
CDLV1603PI CDLV1603PW CDLV1603P CDLV1603PGRY CDLV1603PBK CDLV1603PLA	Single Pole/3-Way, Preset	120V, 1600W	Wide	Ivory White Brown Gray Black Light Almond
ADAPTOR KIT				
CDADAPTORKITI CDADAPTORKITW CDADAPTORKIT CDADAPTORKITGRY CDADAPTORKITBK CDADAPTORKITLA	Decorator-Style Device Adaptor Kit		Narrow	Ivory White Brown Gray Black Light Almond

Features

- Field configurable wall plate system.
- Labeling system.
- Adjustable low end output voltage.
- Shipped with protective film.
- Rugged construction.
- Superior ratings with a minimum of de-rating when ganged.
- Simple to plan the rough-in.
- Available in single pole slide-to-OFF and single pole/3-way preset models.
- Attractive European styling.
- Eye-catching packaging.
- Exclusive adaptor kit to install other decorator-style opening devices under the Titan® wall plate system.
- Blank center plate included.



CDADAPTORKITW

Adaptor kit enables matching installation of standard P&S decorator-style Devices – outlets, switches, GFCIs and more.

For technical specifications, de-rating, and rough-in box charts, see Page U-170.

All devices listed on this page conform to NEMA WD-1 and WD-6. UL Listed and CSA Certified.



COMMERCIAL DIMMERS & FAN SPEED CONTROLS

Titan® Series Fluorescent 2 Wire Dimmers

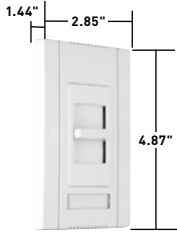

CDFB5W - Narrow

Features

- For use with 2 wire 120V and 277V fluorescent dimming ballasts.
- Field configurable wall plate system.
- Labeling system.
- Adjustable low end output voltage.
- Shipped with protective film.
- Rugged construction.
- Superior ratings with a minimum of de rating when ganged.
- Simple to plan the rough-in.
- Available in single pole slide-to-OFF and single pole/3-way preset models.
- Attractive European styling.
- Eye-catching packaging.
- Exclusive adaptor kit to install other decorator-style opening devices under the Titan® wall plate system. (See Page O-21.)
- Blank center plate included.

CATALOG NUMBER	DESCRIPTION	RATINGS	NARROW OR WIDE	COLOR
FLUORESCENT				
CDFB5I CDFB5W CDFB5 CDFB5GRY CDFB5BK CDFB5LA	2 Wire, Electronic, Single Pole, Slide-to-OFF	5A, 120V	Narrow	Ivory White Brown Gray Black Light Almond
CDFB8I CDFB8W CDFB8 CDFB8GRY CDFB8BK CDFB8LA	2 Wire, Electronic, Single Pole, Slide-to-OFF	8A, 120V	Narrow	Ivory White Brown Gray Black Light Almond
CDFB10I CDFB10W CDFB10 CDFB10GRY CDFB10BK CDFB10LA	2 Wire, Electronic, Single Pole, Slide-to-OFF	10A, 120V	Wide	Ivory White Brown Gray Black Light Almond
CDFB16I CDFB16W CDFB16 CDFB16GRY CDFB16BK CDFB16LA	2 Wire, Electronic, Single Pole, Slide-to-OFF	16A, 120V	Wide	Ivory White Brown Gray Black Light Almond
CDFB7277I CDFB7277W CDFB7277 CDFB7277GRY CDFB7277BK CDFB7277LA	2 Wire, Electronic, Single Pole, Slide-to-OFF	7A, 277V	Wide	Ivory White Brown Gray Black Light Almond
CDFB10277I CDFB10277W CDFB10277 CDFB10277GRY CDFB10277BK CDFB10277LA	2 Wire, Electronic, Single Pole, Slide-to-OFF	10A, 277V	Wide	Ivory White Brown Gray Black Light Almond

For technical specifications, de-rating, and rough-in box charts, see Page U-172.

COMMERCIAL DIMMERS & FAN SPEED CONTROLS

Titan® Series Fluorescent 2 Wire Dimmers

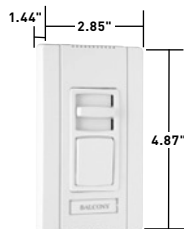

CDFB53PW - Narrow

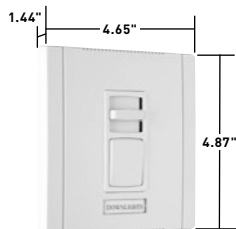

CDFB103PW - Wide

Features

- For use with 2 wire 120V and 277V fluorescent dimming ballasts.
- Field configurable wall plate system.
- Labeling system.
- Adjustable low end output voltage.
- Shipped with protective film.
- Rugged construction.
- Superior ratings with a minimum of de-rating when ganged.
- Simple to plan the rough-in.
- Available in single pole slide-to-OFF and single pole/3-way preset models.
- Attractive European styling.
- Eye-catching packaging.
- Exclusive adaptor kit to install other decorator-style opening devices under the Titan® wall plate system. (See Page O-21.)
- Blank center plate included.

CATALOG NUMBER	DESCRIPTION	RATINGS	NARROW OR WIDE	COLOR
FLUORESCENT				
CDFB53PI CDFB53PW CDFB53P CDFB53PGRY CDFB53PBK CDFB53PLA	2 Wire, Electronic, Single Pole/3-Way, Preset	5A, 120V	Narrow	Ivory White Brown Gray Black Light Almond
CDFB83PI CDFB83PW CDFB83P CDFB83PGRY CDFB83PBK CDFB83PLA	2 Wire, Electronic, Single Pole/3-Way, Preset	8A, 120V	Narrow	Ivory White Brown Gray Black Light Almond
CDFB103PI CDFB103PW CDFB103P CDFB103PGRY CDFB103PBK CDFB103PLA	2 Wire, Electronic, Single Pole/3-Way, Preset	10A, 120V	Wide	Ivory White Brown Gray Black Light Almond
CDFB163PI CDFB163PW CDFB163P CDFB163PGRY CDFB163PBK CDFB163PLA	2 Wire, Electronic, Single Pole/3-Way, Preset	16A, 120V	Wide	Ivory White Brown Gray Black Light Almond
CDFB73P277I CDFB73P277W CDFB73P277 CDFB73P277GRY CDFB73P277BK CDFB73P277LA	2 Wire, Electronic, Single Pole/3-Way, Preset	7A, 277V	Wide	Ivory White Brown Gray Black Light Almond
CDFB103P277I CDFB103P277W CDFB103P277 CDFB103P277GRY CDFB103P277BK CDFB103P277LA	2 Wire, Electronic, Single Pole/3-Way, Preset	10A, 277V	Wide	Ivory White Brown Gray Black Light Almond

For technical specifications, de-rating, and rough-in box charts, see Page U-172.

All devices listed on this page conform to NEMA WD-1 and WD-6. UL Listed and CSA Certified.

COMMERCIAL DIMMERS & FAN SPEED CONTROLS

Titan® Series Fluorescent 3 Wire Dimmers

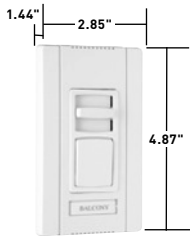

CD3FB163PW - Narrow

Features

- For use with 3 wire 120V and 277V fluorescent dimming ballasts.
- Field configurable wall plate system.
- Labeling system.
- Adjustable low end output voltage.
- Shipped with protective film.
- Rugged construction.
- Superior ratings with a minimum of de-rating when ganged.
- Simple to plan the rough-in.
- Available in single pole slide-to-OFF and single pole/3-way preset models.
- Attractive European styling.
- Eye-catching packaging.
- Exclusive adaptor kit to install other decorator-style opening devices under the Titan® wall plate system. (See Page O-21.)
- Blank center plate included.

CATALOG NUMBER	DESCRIPTION	RATINGS	NARROW OR WIDE	COLOR
FLUORESCENT				
CD3FB16I CD3FB16W CD3FB16 CD3FB16GRY CD3FB16BK CD3FB16LA	3 Wire Electronic, Single Pole, Slide-to-OFF	120V, 16A	Narrow	Ivory
				White
				Brown
				Gray
				Black
				Light Almond
CD3FB163PI CD3FB163PW CD3FB163P CD3FB163PGRY CD3FB163PBK CD3FB163PLA	3 Wire Electronic, Single Pole/3-Way, Preset	120V, 16A	Narrow	Ivory
				White
				Brown
				Gray
				Black
				Light Almond
CD3FB10277I CD3FB10277W CD3FB10277 CD3FB10277GRY CD3FB10277BK CD3FB10277LA	3 Wire Electronic, Single Pole, Slide-to-OFF	277V, 10A	Narrow	Ivory
				White
				Brown
				Gray
				Black
				Light Almond
CD3FB103P277I CD3FB103P277W CD3FB103P277 CD3FB103P277GRY CD3FB103P277BK CD3FB103P277LA	3 Wire Electronic, Single Pole/3-Way, Preset	277V, 10A	Narrow	Ivory
				White
				Brown
				Gray
				Black
				Light Almond

For technical specifications, de-rating, rough-in box charts, and complete list of compatible ballasts, see Pages U-171 – U-173.

COMMERCIAL DIMMERS & FAN SPEED CONTROLS

Titan® Series Fluorescent/LED 4-Wire Dimmers

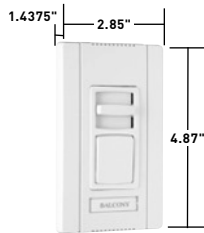

CD4FB3PW - Narrow

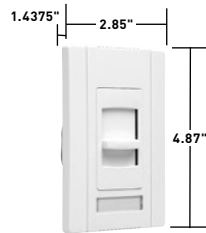

CD4FBLW

Features

- For use with 0-10V, 4 wire or 120V and 277V fluorescent dimming ballasts.
- Field configurable wall plate system.
- Labeling system.
- Adjustable low end output voltage.
- Shipped with protective film.
- Rugged construction.
- Superior ratings with a minimum of de-rating when ganged.
- Simple to plan the rough-in.
- Available in single pole slide-to-OFF and single pole/3-way preset models.
- Attractive European styling.
- Eye-catching packaging.
- Exclusive adaptor kit to install other decorator-style opening devices under the Titan® wall plate system. (See Page O-21.)
- Blank center plate included.

CATALOG NUMBER	DESCRIPTION	RATINGS	NARROW OR WIDE	COLOR
FLUORESCENT				
CD4FBI CD4FBW CD4FB CD4FBGRY CD4FBBK CD4FBLA	Single Pole, Slide-to-OFF	24VDC	Narrow	Ivory White Brown Gray Black Light Almond
CD4FB3PI CD4FB3PW CD4FB3P CD4FB3PGRY CD4FB3PBK CD4FB3PLA	Single Pole/3-Way, Preset	24VDC	Narrow	Ivory White Brown Gray Black Light Almond
BZ50	Power pack for switching load	24VDC	—	
LED 4-WIRE				
CD4FBLI CD4FBLW CD4FBL CD4FBLGRY CD4FBLBK CD4FBLLA	Single Pole, Slide-to-OFF	0-10V	Narrow	Ivory White Brown Gray Black Light Almond
CD4FBL3PI CD4FBL3PW CD4FBL3P CD4FBL3PGRY CD4FBL3PBK CD4FBL3PLA	Single Pole/3-Way Preset	0-10V	Narrow	Ivory White Brown Gray Black Light Almond

Red available made to order.

For technical specifications, de-rating, rough-in box charts, and complete list of compatible ballasts, see Pages U-171 – U-173. Power Pack technical specifications, see Page U-168.

All devices listed on this page conform to NEMA WD-1 and WD-6. UL Listed and CSA Certified.

COMMERCIAL DIMMERS & FAN SPEED CONTROLS

Titan® Series Fan Speed Controls

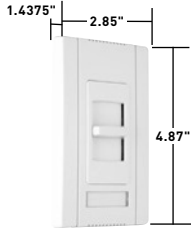

CDSC6W
Narrow

Features

- Field configurable wall plate system.
- Labeling system.
- Shipped with protective film.
- Rugged construction.
- Simple to plan the rough-in.
- Available in single pole slide-to-OFF models.
- Attractive European styling.
- Eye-catching packaging.
- Exclusive adaptor kit to install other decorator-style opening devices under the Titan® wall plate system. (See Page 0-21.)
- Available in both continuously variable and de-hummer styles.
- Blank center plate included.

CATALOG NUMBER	DESCRIPTION	RATINGS	NARROW OR WIDE	COLOR
FAN SPEED CONTROLS				
CDSC6I CDSC6W CDSC6 CDSC6GRY CDSC6BK CDSC6LA	Continuously Variable Speed Fan Speed Control	120V, 6A	Narrow	Ivory White Brown Gray Black Light Almond
CDSC12I CDSC12W CDSC12 CDSC12GRY CDSC12BK CDSC12LA	Continuously Variable Speed Fan Speed Control	120V, 12A	Wide	Ivory White Brown Gray Black Light Almond
CDDH16I CDDH16W CDDH16 CDDH16GRY CDDH16BK CDDH16LA	De-Hummer, 4 Speed Low/Low-Mid/High-Mid/High Fan Speed Control	120V, 1.6A	Narrow	Ivory White Brown Gray Black Light Almond

RESIDENTIAL FAN SPEED CONTROLS

radiant® & Rotary DR Series Fan Speed Controls

the radiant® collection

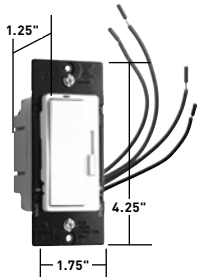

HDH163PMMW

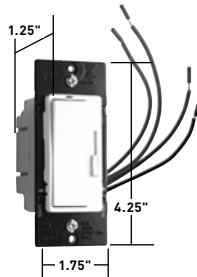

RHDH163PW

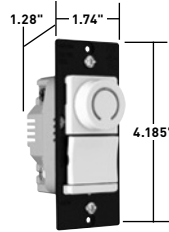

DRSC53PWV

CATALOG NUMBER	DESCRIPTION	RATINGS	COLOR
RADIANT® SINGLE POLE/3-WAY DE-HUMMER MULTI-LOCATION MASTER FAN SPEED CONTROL WITH PRESET			
HDH163PMMTC	3 Interchangeable Face Plates	120V, 1.6A	Ivory, Light Almond, White
HDH163PMMW			White
RADIANT® MULTI-LOCATION DE-HUMMER FAN SPEED CONTROL INTERCHANGEABLE FACE PLATE			
HDHKITAB	radiant® Interchangeable Face Plates		Antique Brass
HDHKITBK			Black
HDHKIT			Brown
HDHKITDB			Dark Bronze
HDHKITGRY			Gray
HDHKITI			Ivory
HDHKITLA			Light Almond
HDHKITNI			Nickel
HDHKITTI			Titanium
HDHKITW			White

CATALOG NUMBER	DESCRIPTION	RATINGS	COLOR
RADIANT® FAN SPEED CONTROLS, DE-HUMMER*, SINGLE POLE/3-WAY			
RHDH163PTC**	Preset, Single Pole/3-Way Three Interchangeable Face Colors	120V, 1.6A	Ivory/White/Light Almond
RHDH163PW	Preset, Single Pole/3-Way		White

*Feature specially designed capacitive circuitry to virtually eliminate fan motor "hum."

**Available in VisionPak™ packaging, add "CCV6" to Catalog Number. Example: RHDH163PTCCCV6.

For additional radiant® products and information, see Pages 0-4 - 0-7.

RESIDENTIAL & LIGHT COMMERCIAL FAN SPEED CONTROLS

CATALOG NUMBER	DESCRIPTION	RATINGS	COLOR
DR SERIES 5A CONTINUOUSLY VARIABLE PRESET FAN SPEED CONTROLS			
DRSC53PIV	Single Pole/3-Way Fan Speed Control	120V, 5A	Ivory
DRSC53PWV			White
DRSC53PV			Brown
DRSC53PBKV			Black
DRSC53PLAV			Light Almond
DR SERIES 1.6A 3-SPEED DE-HUMMER* PRESET FAN SPEED CONTROLS			
DRDH163PIV	Single Pole/3-Way Fan Speed Control with back-lit speed indication	120V, 1.6A	Ivory
DRDH163PWV			White
DRDH163PV			Brown
DRDH163PBKV			Black
DRDH163PLAV			Light Almond

*Feature specially designed capacitive circuitry to virtually eliminate fan motor "hum."

For additional Rotary DR Series products and information, see Page 0-12.

All devices listed on this page conform to NEMA WD-1 and WD-6. UL Listed and CSA Certified.

RESIDENTIAL & LIGHT COMMERCIAL FAN SPEED CONTROLS

LS Series Fan Speed Controls

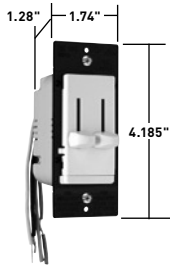

LSDC16LAV

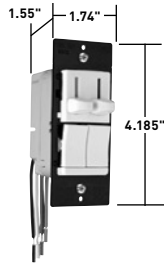

LSDC163PLAV



TM8LMCC8

CATALOG NUMBER	DESCRIPTION	RATINGS	COLOR						
SLIDE FAN SPEED CONTROLS*									
LSSC5I LSSC5W LSSC5 LSSC5BK LSSC5LA	Non-Preset, Single Pole, Adjustable Trim	120V 5A	Ivory White Brown Black Light Almond						
LSSC5PI LSSC5PW LSSC5P LSSC5PBK LSSC5PLA			Preset, Single Pole, Adjustable Trim	120V 5A	Ivory White Brown Black Light Almond				
SLIDE DE-HUMMER CONTROLS**									
LSDH16IV LSDH16WV LSDH16V LSDH16BKV LSDH16LAV					Non-Preset, 4-Speed Fan Control	120V 1.6A	Ivory White Brown Black Light Almond		
DUAL CONTROL SLIDES**									
LSDC16IV LSDC16WV LSDC16V LSDC16BKV LSDC16LAV	Non-Preset, 3-Speed De-Hummer Fan Control With Single Pole Dimmer	120V 1.6A/300W					Ivory White Brown Black Light Almond		
LSDC163PIV LSDC163PWV LSDC163PV LSDC163PBKV LSDC163PLAV			Preset, 3-Speed De-Hummer Fan Control With Single Pole 3-Way Dimmer	120V 1.6A/300W			Ivory White Brown Black Light Almond		
LSDV25IV LSDV25WV LSDV25V LSDV25BKV LSDV25LAV							Non-Preset, Variable Speed Fan Control With Single Pole Dimmer	120V 2.5A/300W	Ivory White Brown Black Light Almond
SINGLE POLE /3-WAY PRESET DIMMER WITH SINGLE POLE/3-WAY 3-SPEED DE-HUMMER FAN CONTROL									
LSCLDC163PBK LSCLDC163P LSCLDC163PI LSCLDC163PLA LSCLDC163PW					Single Pole/3-Way Preset CFL/LED Dimmer With Single Pole/3-Way 3-Speed De-Hummer Fan Control	1.6A, 300W (Fan Control); 120VAC, 60Hz, 450W (Dimmer)			Black Brown Ivory Light Almond White

CATALOG NUMBER	DESCRIPTION	COLOR	
ACCESSORIES FOR LS SERIES			
LRKIV LRKWV LRKVV LRKBKV LRKLAV	Replacement Knobs for LS Series Dual Slides	Ivory White Brown Black Light Almond	
LLRKIV LLRKWV LLRKVV LLRKBKV LLRKLAV		Large Replacement Knobs for LS Series Single Slides	Ivory White Brown Black Light Almond

* Available in VisionPak™ packaging, add "V" to Catalog Number. Example: LSSC5IV.

**Available in VisionPak™ only.

Feature specially designed capacitive circuitry to virtually eliminate fan motor "hum."

CATALOG NUMBER	RATING		COLOR
	A.	VAC	
SNAP-IN LIGHT MODULE			
TM8LMCC8	15	120/125	Clear

For additional LS Series products and information, see Pages O-8 – O-11.

All devices listed on this page conform to NEMA WD-1 and WD-6. UL Listed and CSA Certified.

RESIDENTIAL & LIGHT COMMERCIAL FAN SPEED CONTROLS

Wide Slide Series & TradeMaster® Toggle Fan Speed Controls

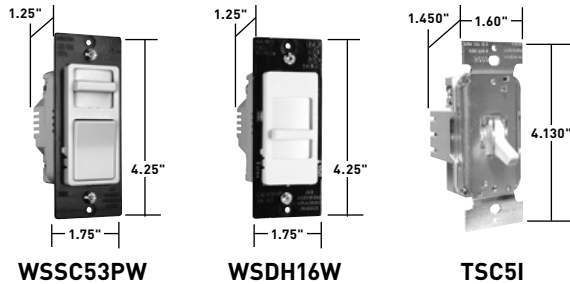

CATALOG NUMBER	DESCRIPTION	RATINGS	COLOR
WIDE SLIDE INTERCHANGEABLE FACE FAN SPEED CONTROLS			
WSSC53PTC*	Preset, Variable Speed, 3 Face Colors	120V, 5A	Ivory/White/Lt. Almond
WSSC53PW	White Face Only	120V, 5A	White
WIDE SLIDE DE-HUMMER* FAN SPEED CONTROLS			
WSDH16TC	De-Hummer Fan Speed Control	120V, 1.6A	Ivory, White, Lt. Almond
WSDH16W			

*Feature specially designed capacitive circuitry to virtually eliminate fan motor "hum."

CATALOG NUMBER	DESCRIPTION	RATINGS	COLOR
TRADEMASTER® TOGGLE DE-HUMMER* FAN SPEED CONTROLS			
TDDH163PI	De-Hummer Fan Speed Control	120V, 1.6A	Ivory
TDDH163PW			White
TDDH163P			Brown
TDDH163PBK			Black
TDDH163PLA			Light Almond

*Feature specially designed capacitive circuitry to virtually eliminate fan motor "hum."

CATALOG NUMBER	DESCRIPTION	RATINGS	COLOR
TRADEMASTER® TOGGLE FAN SPEED CONTROLS*			
TSC5I	Non-Preset, Adjustable Trim	120V, 5A	Ivory
TSC5W			White
TSC5LA			Light Almond

* Available in VisionPak™ packaging, add "V" to Catalog Number. Example: SS600LAV.

For additional TradeMaster® Toggle products and information, see Page 0-15 – 0-17.

COMMERCIAL FAN SPEED CONTROLS

Titan® Series Fan Speed Controls

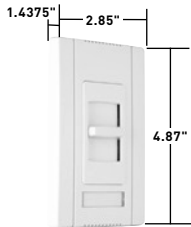

CDSC6W
Narrow

Features

- Field configurable wall plate system.
- Labeling system.
- Shipped with protective film.
- Rugged construction.
- Simple to plan the rough-in.
- Available in single pole slide-to-OFF models.
- Attractive European styling.
- Eye-catching packaging.
- Exclusive adaptor kit to install other decorator-style opening devices under the Titan® wall plate system. (See Page 0-21.)
- Available in both continuously variable and de-hummer styles.
- Blank center plate included.

CATALOG NUMBER	DESCRIPTION	RATINGS	NARROW OR WIDE	COLOR
FAN SPEED CONTROLS				
CDSC6I CDSC6W CDSC6 CDSC6GRY CDSC6BK CDSC6LA	Continuously Variable Speed Fan Speed Control	120V, 6A	Narrow	Ivory White Brown Gray Black Light Almond
CDSC12I CDSC12W CDSC12 CDSC12GRY CDSC12BK CDSC12LA	Continuously Variable Speed Fan Speed Control	120V, 12A	Wide	Ivory White Brown Gray Black Light Almond
CDDH16I CDDH16W CDDH16 CDDH16GRY CDDH16BK CDDH16LA	De-Hummer*, 4 Speed Low/Low-Mid/High-Mid/High Fan Speed Control	120V, 1.6A	Narrow	Ivory White Brown Gray Black Light Almond

* Feature specially designed capacitive circuitry to virtually eliminate fan motor "hum."

For additional Titan® Series products and information, see Pages 0-19 – 0-26.

SLATER® PLASTIC BOXES



Durable, impact-resistant thermoplastic boxes in a full range of sizes — complemented by innovative extras that cut installation time.

New Work Switch & Outlet Boxes, Wall-Box Extension Rings	P-2
Old Work Boxes & Shallow Boxes	P-4
Low-Voltage Brackets	P-5
Wood & Steel Stud Bracket Boxes	P-6
Screw Mount Steel Stud Boxes	P-7
4" Square Boxes & Covers	P-8
4" Round Ceiling Boxes	P-9
Round Ceiling Boxes	P-12
Tamper-Resistant Floor Box Assemblies	P-13, P-17
Tamper-Resistant Round Floor Box Assemblies	P-15
Recessed TV Boxes	P-18
Applications & Product Features	P-19

Featured Products



**TV1WTVSSBK
RECESSED
TV BOX**

P-18



**LABOR-SAVING
QUICK/CLICK®
BOXES**

P-2

SLATER® PLASTIC BOXES

Switch & Outlet Boxes With Captive Mounting Nails on Each End with Quick/Click®



S118R



S122R

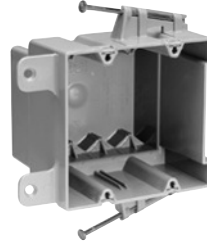

S235RAC

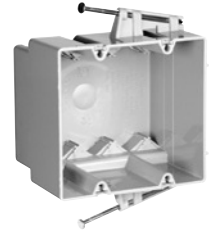

S235RACMH

CATALOG NUMBER	CU. IN. VOL.	DESCRIPTION	DIMENSIONS			WIRE FILL (AWG)	QTY. PER CARTON
			L	W	D		
SWITCH & OUTLET BOXES WITH QUICK/CLICK®							
S118R	18.0	Single gang. 2 Quick/Entries® each end.	3¾	2¼	2 ²³ / ₃₂	9 No. 14 8 No. 12 7 No. 10	100
S235RAC	35.0	Two gang. 4 Auto/Clamps® each end.	3 ³¹ / ₃₂	3 ³¹ / ₃₂	3 ³ / ₈	17 No. 14 15 No. 12 14 No. 10	50
S235RACMH	35.0	Two gang. 4 Auto/Clamps® each end. 3" depth for manufactured housing walls.	3¾	4 ¹ / ₁₆	3	17 No. 14 15 No. 12 14 No. 10	100
S354RAC	54.0	Three gang. 6 Auto/Clamps® each end.	3 ³¹ / ₃₂	5 ²⁵ / ₃₂	3	27 No. 14 24 No. 12 21 No. 10	50
S468RAC	68.0	Four gang. Rear stabilizing bar virtually eliminates inward movement. 6 Auto/Clamps® each end.	3 ¹³ / ₁₆	7 ¹³ / ₁₆	3	34 No. 14 30 No. 12 27 No. 10	25
DEEP SWITCH & OUTLET BOXES WITH QUICK/CLICK®							
S122R	22.5	Single gang deep. 2 Quick/Entries® each end. Extra deep for dimmers, GFCIs and thermostats, yet suitable for 2 x 4 construction.	3¾	2¼	3 ³ / ₈	11 No. 14 10 No. 12 9 No. 10	100



S354RAC

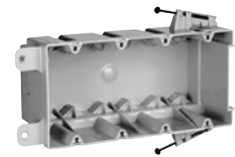

S468RAC

All boxes are UL Listed.
UL Classified for 2 Hour Fire Resistance. (Does not apply to S468RAC.)

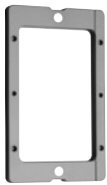

EXT1

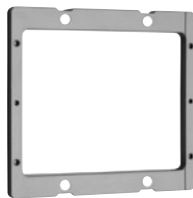

EXT2

CATALOG NUMBER	CU. IN. VOL.	DESCRIPTION	QTY. PER CARTON
WALL BOX EXTENSION RINGS			
EXT1	1.0	Single gang. ¼" thick. Stackable.	10
EXT2	2.0	Two gang. ¼" thick. Stackable.	10

SLATER® PLASTIC BOXES

Switch & Outlet Boxes with Captive Mounting Nails on Each End



P118R



P1-18-RN



P1-22-R



P122RN



P1-22-N



PH1-22-R

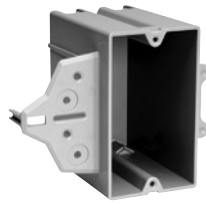

P1-22-C



P2-35-RAC



P2-35-RACMH



P354RACMH

CATALOG NUMBER	CU. IN. VOL.	DESCRIPTION	DIMENSIONS			WIRE FILL (AWG)	QTY. PER CARTON
			L	W	D		
SWITCH & OUTLET BOXES WITH THREADED MOUNTING HOLES							
P118R	18.0	Single gang. 2 Quick/Entries® each end.	3¾	2¼	2 ²³ / ₃₂	9 No. 14 8 No. 12 7 No. 10	100
P118RN	18.0	Single gang. Reverse angled captive mounting nail. 2 Quick/Entries® each end. Used for manufactured housing.	3¾	2¼	2 ²³ / ₃₂	9 No. 14 8 No. 12 7 No. 10	100
P122C	22.0	Single gang. With EZ Grip – a temporary hold feature.	3¾	2¼	4	11 No. 14 10 No. 12 9 No. 10	100
PH122R	22.0	Single gang. Horizontal. Captive mounting nail each side.	3¾	2¼	3 ⁷ / ₈	11 No. 14 10 No. 12 9 No. 10	100
P235RAC	35.0	Two gang. 4 Auto/Clamps® each end.	3 ³¹ / ₃₂	3 ³¹ / ₃₂	3 ³ / ₈	17 No. 14 15 No. 12 14 No. 10	100
P235RACMH	35.0	Two gang. 4 Auto/Clamps® each end. 3" depth for manufactured housing walls.	3 ³¹ / ₃₂	3 ³¹ / ₃₂	3	17 No. 14 15 No. 12 14 No. 10	100
P354RACMH	54.0	Three gang. 6 Auto/Clamps® each end. 3 ¹ / ₁₆ " depth for manufactured housing walls.	3 ¹³ / ₁₆	5 ¹⁵ / ₁₆	3 ¹ / ₁₆	27 No. 14 24 No. 12 21 No. 10	50
DEEP SWITCH & OUTLET BOXES WITH THREADED MOUNTING HOLES							
P122R	22.5	Single gang deep. 2 Quick/Entries® each end. Extra deep for dimmers, GFCIs and thermostats, yet suitable for 2 x 4 construction.	3¾	2¼	3 ³ / ₈	11 No. 14 10 No. 12 9 No. 10	100
P122RN	22.5	Single gang deep. Reverse angled captive mounting nail. 2 Quick/Entries® each end. Extra deep for dimmers, GFCIs and thermostats, yet suitable for 2 x 4 construction.	3¾	2¼	3 ³ / ₈	11 No. 14 10 No. 12 9 No. 10	100
P122N	22.5	Single gang deep. Vertical bracket mount.	3¾	2¼	3 ³ / ₈	11 No. 14 10 No. 12 9 No. 10	100

All boxes are UL Listed.
UL Classified for 2 Hour Fire Resistance (Does not apply to P122N.)

All devices listed on this page conform to NEMA OS2.

SLATER® PLASTIC BOXES

Old Work Boxes & Shallow Boxes

S352W

Old Work Switch & Outlet Box with Quick/Click®

- A. Quick/Click feature** secures devices quickly and easily. Does not strip when over-torqued. See Page M-20 for details.
- B. 4 Auto/Clamps® on each end** eliminate the need for separate cable clamps. See Page M-20 for details.
- C. Metal swing bracket** for quick mounting in existing walls.
- D. Divider plate** (LVDIV1, sold separately) used when installing line and low-voltage devices or multiple 277 volt devices in same box. See Page M-5 for details.
- E. Swing bracket** adjusts from 1-1/4" to 1/8".

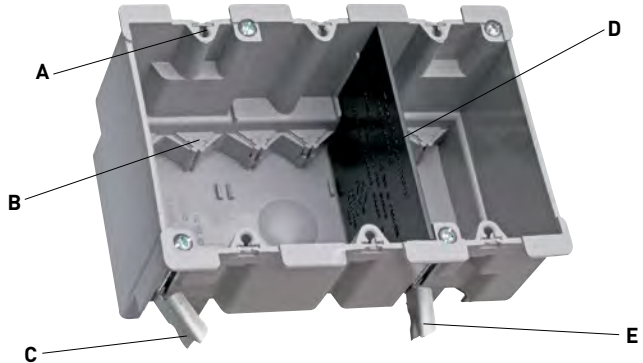

3 Gang Old Work Box shown with Divider Plate, LVDIV1

Big 52 cubic inch capacity.

Easy installation, rectangular cutout.



S118W



S122W



S232W



M118W



P108N



P108W

CATALOG NUMBER	CU. IN. VOL.	DESCRIPTION	DIMENSIONS			WIRE FILL (AWG)	QTY. PER CARTON
			L	W	D		
OLD WORK SWITCH & OUTLET BOXES WITH QUICK/CLICK							
S116W	16.0	Single gang. Swing-bracket for mounting adjusts from 1/4" down to 1/8". 2 Auto/Clamps® each end.	3 3/4	2 1/4	2 3/4	8 No. 14 7 No. 12 6 No. 10	100
S118W	18.0	Single gang. Swing-bracket for mounting adjusts from 1/4" down to 1/8". 2 Auto/Clamps® each end.	3 3/4	2 1/4	3 1/32	9 No. 14 8 No. 12 7 No. 10	100
S232W	32.0	Two gang. Swing-bracket for mounting adjusts from 1/4" down to 1/8". 4 Auto/Clamps® each end.	3 3/4	4 1/16	3 1/32	16 No. 14 14 No. 12 12 No. 10	50
S352W	52.0	Three gang. Swing-bracket for mounting adjusts from 1/4" down to 1/8". 6 Auto/Clamps® each end.	3 3/4	5 7/8	3 1/32	26 No. 14 23 No. 12 20 No. 10	10
M118W NEW! P&S Exclusive	18.0	Single gang metal box. Swing bracket for mounting adjusts 1/4" down to 1/8". Four 3/4"/1 1/4" KOs plus integral Romex clamp.	3 3/4	2 1/4	3	8 No. 14 7 No. 12 6 No. 10	50
DEEP OLD WORK SWITCH & OUTLET BOXES WITH QUICK/CLICK							
S122W	22.0	Single gang deep. Swing-bracket for mounting adjusts from 1/4" down to 1/8". 2 Auto/Clamps® each end.	3 3/4	2 5/16	3 1/2	-	50
OLD WORK SWITCH & OUTLET BOXES WITH THREADED MOUNTING HOLES							
P116W	16.0	Single gang. Swing-bracket for mounting adjusts from 1/4" down to 1/8". 2 Auto/Clamps® each end.	3 3/4	2 1/4	2 3/4	8 No. 14 7 No. 12 6 No. 10	100
SHALLOW SWITCH & OUTLET BOXES for use in limited depth application							
P108W	8.0	Single gang. Old work flange box for retrofit applications.	3 3/4	2 5/16	1 1/8	-	20
P108N	8.0	Single gang. With vertical side bracket for new construction applications.	3 3/4	2 5/16	1 1/8	-	20

All boxes are UL listed.
UL Classified for 2 Hour Fire Resistance. (Does not apply to S232W, S352W, P108W, and P108N.)

SLATER® PLASTIC BOXES

SLATER® PLASTIC BOXES

Low-Voltage Brackets

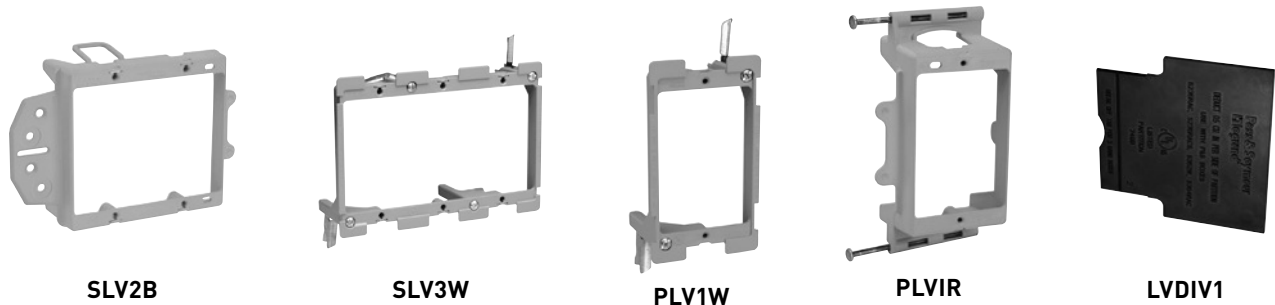

SLV2B

SLV3W

PLV1W

PLVIR

LVDIV1

CATALOG NUMBER	CU. IN. VOL.	DESCRIPTION	DIMENSIONS			WIRE FILL (AWG)	QTY. PER CARTON
			L	W	D		
LOW-VOLTAGE BRACKETS WITH QUICK/CLICK® for class 2 low-voltage applications							
SDV2B	22.5	Two gang. For dual-voltage. Face mount box and bracket for new construction.	3¾	4	3¾	11 No. 14 10 No. 12 9 No. 10	12
SLV1R	-	Single gang. Nail on for new construction.	3¾	2¼	-	-	12
SLV1S	-	Single gang. Nail on for new construction.	3¾	2¼	-	-	12
SLV1B	-	Single gang. Face mount bracket for new construction.	3¾	2¼	-	-	12
SLV2B	-	Two gang. Face mount bracket for new construction.	3¾	4	-	-	12
SLV1W	-	Single gang. Swing bracket mount for old work.	3¾	2¼	-	-	12
SLV2W	-	Two gang. Swing bracket mount for old work.	3¾	4	-	-	12
SLV3W	-	Three gang. Swing bracket mount for old work.	3¾	6	-	-	12
LOW-VOLTAGE BRACKETS for class 2 low-voltage applications							
P100WD	8.0	Single Gang. Gangable. Swing bracket for mounting, adjusts from 1¼" down to 1/8", for old work, stand alone applications.	3¾	2	-	-	15
P100ND	8.0	Single gang. With vertical side bracket for new construction, with wire retaining fingers.	3¾	2¾	1¼	-	15
PDV2B	22.5	Two gang. For dual-voltage. Face mount box and bracket for new construction.	3¾	4	3¾	11 No. 14 10 No. 12 9 No. 10	12
PLV1R*	-	Single gang. Nail on for new construction.	3¾	2¼	-	-	12
PLV1S	-	Single gang. Screw on for new construction.	3¾	2¼	-	-	12
PLV1B*	-	Single gang. Face mount bracket for new construction.	3¾	2¼	-	-	12
PLV2B	-	Two gang. Face mount bracket for new construction.	3¾	4	-	-	12
PLV1W*	-	Single gang. Swing bracket mount for old work.	3¾	2¼	-	-	12
PLV2W	-	Two gang. Swing bracket mount for old work.	3¾	4	-	-	12
PLV3W	-	Three gang. Swing bracket mount for old work.	3¾	6	-	-	12
DIVIDER PLATE							
LVDIV1	-.5	Suitable for low-voltage or multiple 277V devices. For use with S235RAC, S235RACS, P235RAC, S235S50AC, S354RAC and S352W.	-	-	-	-	12

All boxes are UL listed.

* Bulk pack solutions are available for 100 packs.
Please add suffix "BP" to catalog numbers (i.e., PLV1WBP - bulk pack PLV1W).

SLATER® PLASTIC BOXES

Wood & Steel Stud Bracket Boxes With Offset Bracket for Wood and/or Steel Mounting

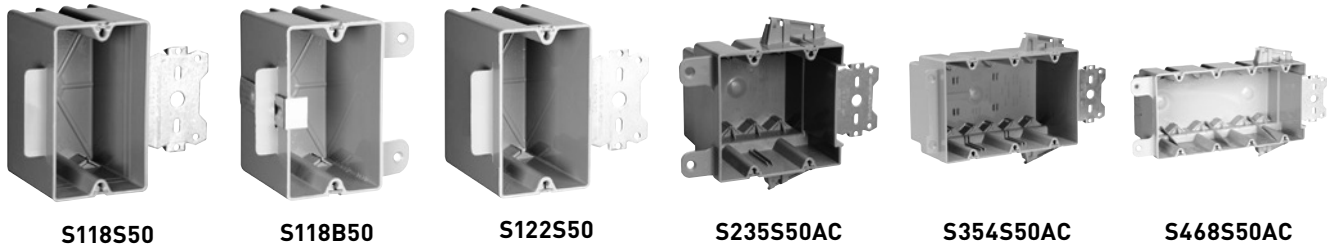

CATALOG NUMBER	CU. IN. VOL.	DESCRIPTION	DIMENSIONS			WIRE FILL (AWG)	QTY. PER CARTON
			L	W	D		
WOOD & STEEL STUD BRACKET BOXES WITH QUICK/CLICK®							
S118S50	18.0	Single gang. 3/8" offset for wood and steel stud mounting. 2 Quick/Entries® each end. For use with 3/8" to 5/8" wallboard.	3 3/4	2 1/4	2 23/32	9 No. 14 8 No. 12 7 No. 10	100
S118B50	18.0	Single gang. 1/2" offset for wood and steel stud mounting. Rear stabilizing bar virtually eliminates inward movement. 2 Quick/Entries® each end. For use with 3/8" to 5/8" wallboard.	3 3/4	2 1/4	2 3/4	9 No. 14 8 No. 12 7 No. 10	100
S235S50AC	35.0	Two gang. 3/8" offset for wood and steel stud mounting. 4 Auto/Clamps® each end. For use with 3/8" to 5/8" wallboard.	3 31/32	3 31/32	3 3/8	17 No. 14 15 No. 12 14 No. 10	50
S354S50AC	54.0	Three gang. 3/8" offset for wood and steel stud mounting. 6 Auto/Clamps® each end. For use with 3/8" to 5/8" wallboard.	3 3/4	5 25/32	3	27 No. 14 24 No. 12 21 No. 10	25
S468S50AC	68.0	Four gang. 3/8" offset for wood and steel stud mounting. Rear stabilizing bar virtually eliminates inward movement. 6 Auto/Clamps® each end. For use with 3/8" to 5/8" wallboard.	3 3/4	7 13/16	3	34 No. 14 30 No. 12 27 No. 10	25
DEEP WOOD & STEEL STUD BRACKET BOXES WITH QUICK/CLICK®							
S122S50	22.5	Single gang deep. 3/8" offset for wood and steel stud mounting. 2 Quick/Entries® each end. For use with 3/8" to 5/8" wallboard.	3 3/4	2 1/4	3 3/8	11 No. 14 10 No. 12 9 No. 10	100

All boxes are UL Listed.
UL Classified for 2 Hour Fire Resistance. (Does not apply to S468S50AC.)

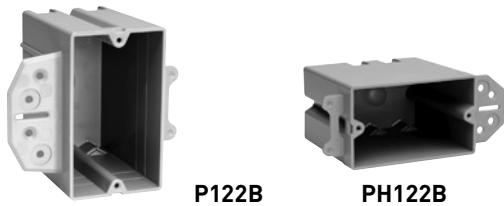

CATALOG NUMBER	CU. IN. VOL.	DESCRIPTION	DIMENSIONS			WIRE FILL (AWG)	QTY. PER CARTON
			L	W	D		
STEEL STUD BRACKET BOXES WITH QUICK/CLICK®							
S122B	22.0	Single gang. 1/2" offset for steel stud mount only. 2 stabilizer legs.	3 3/4	2 1/4	4 1/4	11 No. 14 10 No. 12 9 No. 10	100
SH122B	22.0	Single gang. Horizontal. 1/2" offset for wood or steel stud mount. 2 stabilizer legs.	3 3/4	2 1/4	3 3/8	11 No. 14 10 No. 12 9 No. 10	100
STEEL STUD BRACKET BOXES							
P122B	22.0	Single gang. 1/2" offset for steel stud mount only. 2 stabilizer legs.	3 3/4	2 1/4	4 1/4	11 No. 14 10 No. 12 9 No. 10	100
PH122B	22.0	Single gang. Horizontal. 1/2" offset for wood or steel stud mount. 2 stabilizer legs.	3 3/4	2 1/4	3 3/8	11 No. 14 10 No. 12 9 No. 10	100
S50BRACKET	N/A	Steel stud bracket only for use with P235RAC, P354RAC, S235RAC, S354RAC, S468RAC	N/A	N/A	N/A	N/A	50

All boxes are UL Listed. UL Classified for 2 Hour Fire Resistance.

SLATER® PLASTIC BOXES

Screw Mount Steel Stud Boxes With Captive Combo Head Self Tapping Mounting Screws on Each End



CATALOG NUMBER	CU. IN. VOL.	DESCRIPTION	DIMENSIONS			WIRE FILL (AWG)	QTY. PER CARTON
			L	W	D		
SCREW MOUNT, STEEL STUD BOXES WITH QUICK/CLICK®							
S118RS	18.0	Single gang. 2 Quick/Entries® each end.	3¾	2¼	2 ²³ / ₃₂	9 No. 14 8 No. 12 7 No. 10	100
S235RACS	35.0	Two gang. 4 Auto/Clamps® each end.	3 ³¹ / ₃₂	3 ³¹ / ₃₂	3 ³ / ₈	17 No. 14 15 No. 12 14 No. 10	50
S235RACSMH	35.0	Two gang. 4 Auto/Clamps® each end. 3" depth for manufactured housing walls.	3¾	4 ¹ / ₁₆	3	17 No. 14 15 No. 12 14 No. 10	100
S354RACS	54.0	Three gang. 6 Auto/Clamps® each end.	3 ³¹ / ₃₂	5 ²⁵ / ₃₂	3	27 No. 14 24 No. 12 21 No. 10	50
S468RACS	68.0	Four gang. 6 Auto/Clamps® each end. Rear stabilizing bar virtually eliminates inward movement.	3 ¹³ / ₁₆	7 ¹³ / ₁₆	3	34 No. 14 30 No. 12 27 No. 10	25
DEEP SCREW MOUNT, STEEL STUD BOXES WITH QUICK/CLICK®							
S122RS	22.5	Single gang deep. 2 Quick/Entries® each end. Extra deep for dimmers, GFCIs and thermostats, yet suitable for 2 x 4 construction.	3¾	2¼	3 ³ / ₈	11 No. 14 10 No. 12 9 No. 10	100

All boxes are UL Listed. UL Classified for 2 Hour Fire Resistance. (Does not apply to S468RACS.)
 Note: 3¼" self-tapping, drill-point screws. Nails are 3¼".



CT1

CATALOG NUMBER	DESCRIPTION	QTY. PER CARTON
CRIMPING TOOL FOR ATTACHING STEEL STUD BOXES		
CT1	Crimping tool for attaching boxes to steel studs. Comes equipped with long and short anvils to meet most installation requirements.	1

SLATER® PLASTIC BOXES

4" Square Boxes & Covers

4SBC

RC1

RC2

S4418BAC

S4421RAC

S4421SAC

CATALOG NUMBER	CU. IN. VOL.	DESCRIPTION	DIMENSIONS			WIRE FILL (AWG)	QTY. PER CARTON
			L	W	D		
COVERS FOR 4" SQUARE BOXES							
4SBC	-	4" square flat blank cover - gray	4 1/4	4 1/4	N/A	-	50
4SBCW	-	4" square flat blank cover - white	4 1/4	4 1/4	N/A	-	50
RC1	3.2	Single gang device cover, raised 3/8"	4 1/4	4 1/4	3/8	-	100
RC2	5.3	Two gang device cover, raised 3/8"	4 1/4	4 1/4	3/8	-	100
4" SQUARE BOXES WITH THREADED MOUNTING HOLES							
S4418BAC	17.0	Shallow 4" square. Captive mounting nail each end. 2 Auto/Clamps® each end. 2 #8 mounting screws factory installed.	4 1/4	4 1/4	1 1/4	9 No. 14 8 No. 12 7 No. 10	50
S4421RAC	21.0	4" square. Captive mounting nail each end. 3 Auto/Clamps® each end, 2 on side opposite to nails. 2 #8 mounting screws factory installed.	4 1/4	4 1/4	1 1/2	10 No. 14 9 No. 12 8 No. 10	100
S4421SAC	21.0	4" square. For wood and steel stud mounting. 3 Auto/Clamps each end, 2 on side opposite bracket. 2 #8 mounting screws factory installed.	4 1/4	4 1/4	1 1/2	10 No. 14 9 No. 12 8 No. 10	50
S4435RAC	35.0	4" square. Captive mounting nail each end. 3 Auto/Clamps® each end, 2 on side adjacent to nails. 2 #8 mounting screws factory installed.	4 1/4	4 1/4	2 3/8	17 No. 14 15 No. 12 14 No. 10	50
S4435SAC	35.0	4" square. For wood and steel stud mounting. 3 Auto/Clamps® each end, 2 on side opposite bracket. 2 #8 mounting screws factory installed.	4 1/4	4 1/4	2 3/8	17 No. 14 15 No. 12 14 No. 10	50

S4435RAC

S4435SAC

All boxes are UL Listed. UL Classified for 2 Hour Fire Resistance. (Does not apply to 4SBC and 4SBCW.)

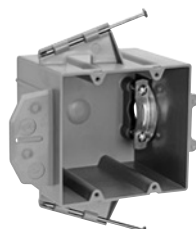
P242SRD

P242RRD

CATALOG NUMBER	CU. IN. VOL.	DESCRIPTION	DIMENSIONS			WIRE FILL (AWG)	QTY. PER CARTON
			L	W	D		
RANGE & DRYER BOXES							
P242SRD	42.0	1/2" offset for wood or steel stud mount with metal cable clamp. Captive mounting screw each end.	3 3/4	4	4	16 No. 10 14 No. 8 8 No. 6	12
P242RRD	42.0	1/2" offset for wood or steel stud mount with metal cable clamp. Captive mounting nail each end.	3 3/4	4	4	16 No. 10 14 No. 8 8 No. 6	12

All boxes are UL Listed. UL Classified for 2 Hour Fire Resistance (pending).

SLATER® PLASTIC BOXES

4" Round Ceiling Boxes

S120JFAN

Fan Box

- A. Angled, rugged, metal mounting bracket** safely and securely fastens fans or fixtures to the building structure.
- B. Dual mounting** accepts fans or fixtures with 2.75" or 3.5" straps.
- C. Auto Clamp® cable clamps molded in** — hold wire securely in box.
- D. Phillips-head screws (#10-32 x 3")** mount the fan or fixture directly to the metal bracket.
- E. Ringed nails for tighter grip.**
- F. Depth-mounting gauge** at bottom of bracket helps you align the box at the proper depth relative to the ceiling.

Fan mounts directly to bracket through box with #10-32 screws (provided).

Large, 20.25 cubic inch capacity for extra wiring space.

Constructed of impact-resistant Noryl® thermoplastic, making it virtually unbreakable and non-conductive.

UL Listed for fan and fixture support.

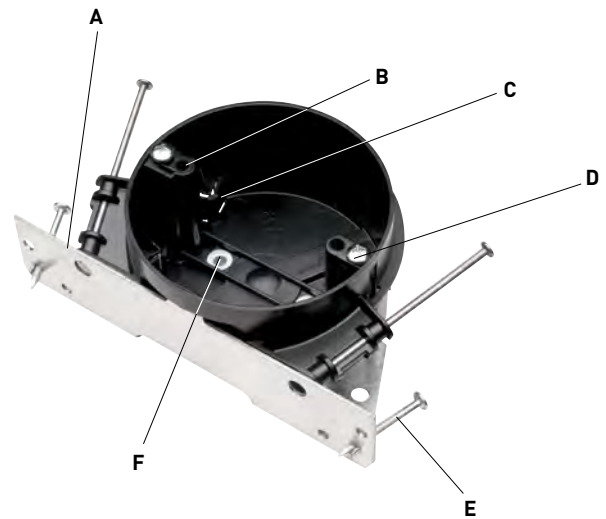

S116FAN

4" Round Direct Mount Ceiling Fan Box

- A. Impact-resistant Noryl®** means no ground wiring as with metal boxes.
- B. Screw lock** holds screws in box until needed. No lost hardware and no broken spiral saw bits.
- C. Mounts directly under a joist or on a joist cross member.**

Easy installation. One #10 x 1/4" screw holds the box at rough in. Two factory-supplied #10 x 2" screws secure the fan or fixture through the box, directly to the joist.

UL Listed for fan and fixture support.



SLATER® PLASTIC BOXES

4" Round Ceiling Boxes With Dual Threaded Mounting Holes

S120JFAN

S120BFAN

S120RFAN

S109FAN

S116FAN

CATALOG NUMBER	CU. IN. VOL.	DESCRIPTION	DIMENSIONS (IN.)		WIRES (AWG)	QTY. PER CARTON	UL LISTED MAX. WEIGHT RATING	
			DIA.	DEPTH			FAN	FIXTURE
FAN BOXES – FAN & FIXTURE RATED								
S120JFAN	20.25	Ceiling Fan Box – Premium Grade with integral fan mounting bracket and 4 Auto/Clamps®.	4	2 ³ / ₁₆	10 No. 14 9 No. 12 8 No. 10	12	70 lbs.	150 lbs.
S120BFAN	20.25	Ceiling Fan Box – Construction Grade with 4 Auto/Clamps®.	4	2 ³ / ₁₆	10 No. 14 9 No. 12 8 No. 10	30	70 lbs.	70 lbs.
S120RFAN	20.25	Ceiling Fan Box – Standard Grade 4 Auto/Clamps® with 2 captive mounting nails.	4	2 ³ / ₁₆	10 No. 14	30	35 lbs.	50 lbs.
4" ROUND DIRECT MOUNT CEILING FAN BOXES – FAN & FIXTURE RATED								
S116FAN	16	Ceiling Fan Box – with Direct Mount.	4	2 ³ / ₁₆	8 No. 14 7 No. 12 6 No. 10	24	70 lbs.	210 lbs.
S109FAN	9	Ceiling Fan Box – with Direct Mount. Suitable for single or double joist.	4	2 ³ / ₁₆	4 No. 14 4 No. 12 3 No. 10	24	70 lbs.	210 lbs.

All boxes are UL listed.
UL Classified for 2 Hour Fire Resistance. Dual mounting accommodates both 2.75" and 3.5" fixtures.

SLATER® PLASTIC BOXES

4" Round Ceiling Boxes With Dual Threaded Mounting Holes

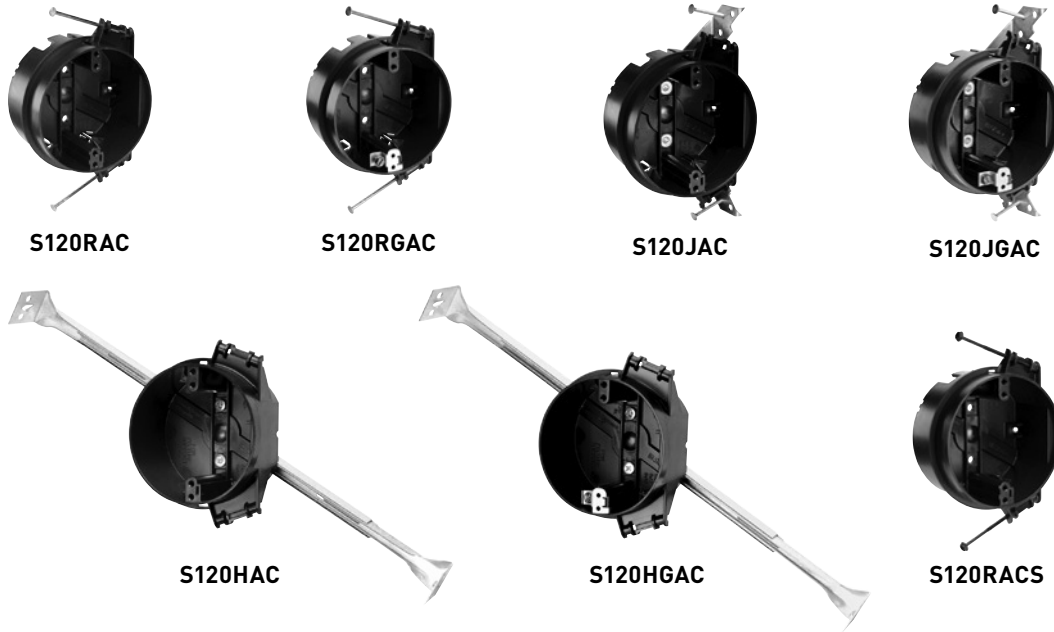

CATALOG NUMBER	CU. IN. VOL.	DESCRIPTION	DIMENSIONS (IN.)		WIRES (AWG)	QTY. PER CARTON	UL LISTED MAX. WEIGHT RATING FIXTURE
			DIA.	DEPTH			
CEILING BOXES							
S120RAC	20.25	4" round. 2 captive mounting nails. 4 Auto/Clamps.	4	2 ³ / ₁₆	10 No. 14 9 No. 12 8 No. 10	50	50 lbs.
S120RGAC	20.25	4" round with ground lug. 2 captive mounting nails. 4 Auto/Clamps.	4	2 ³ / ₁₆	10 No. 14 9 No. 12 8 No. 10	50	50 lbs.
S120JAC	20.25	4" round. J-bracket with 2 captive mounting nails. 4 Auto/Clamps.	4	2 ³ / ₁₆	10 No. 14 9 No. 12 8 No. 10	50	50 lbs.
S120JGAC	20.25	4" round with ground lug. J-bracket with 2 captive mounting nails. 4 Auto/Clamps.	4	2 ³ / ₁₆	10 No. 14 9 No. 12 8 No. 10	50	50 lbs.
S120HAC	20.25	4" round. Bar-hanger adjusts to 16" or 24" joist spacing. 4 Auto/Clamps.	4	2 ³ / ₁₆	10 No. 14 9 No. 12 8 No. 10	50	50 lbs.
S120HGAC	20.25	4" round with ground lug. Bar-hanger adjusts to 16" or 24" joist spacing. 4 Auto/Clamps.	4	2 ³ / ₁₆	10 No. 14 9 No. 12 8 No. 10	50	50 lbs.
S120RACS	20.25	4" round. 2 captive mounting screws. 4 Auto/Clamps.	4	2 ³ / ₁₆	10 No. 14 9 No. 12 8 No. 10	50	50 lbs.

All boxes are UL listed. UL Classified for 2 Hour Fire Resistance. Dual mounting accommodates both 2.75" and 3.5" fixtures.

CATALOG NUMBER	DESCRIPTION	QTY. PER CARTON
COVERS FOR 4" ROUND BOXES		
4RBC	4" round flat blank cover – gray	50
4RBCW	4" round flat blank cover – white	50



4RBC

All devices listed on this page conform to NEMA OS2.

SLATER® PLASTIC BOXES

Round Ceiling Boxes

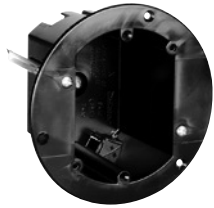
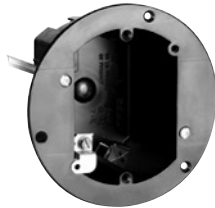
C118WAC

C118WGAC

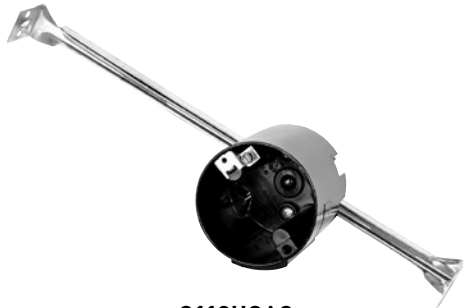
C118RAC

C118RGAC

C118HGAC

C118HAC

CATALOG NUMBER	CU. IN. VOL.	DESCRIPTION	DIMENSIONS (IN.)		WIRES (AWG)	QTY. PER CARTON	UL LISTED
			DIA.	DEPTH			MAX. WEIGHT RATING
3 3/4" ROUND OLD WORK BOXES							
C118WAC	18.0	3 3/4" round. Swing brackets for mounting adjust from 1 1/4" down to 1/8". 4 Auto/Clamps®. Includes device mounting holes.	3 3/4"	2 1/16"	9 No. 14 8 No. 12 7 No. 10	50	—
C118WGAC	18.0	3 3/4" round. With grounding lug. Swing brackets for mounting adjust from 1 1/4" down to 1/8". 4 Auto/Clamps®. Includes device mounting holes.	3 3/4"	2 1/16"	9 No. 14 8 No. 12 7 No. 10	50	—
3 3/4" ROUND CEILING BOXES*							
C118RAC	18.0	3 3/4" round. 2 captive mounting nails. 4 Auto/Clamps.	3 3/4"	3 5/32"	9 No. 14 8 No. 12 7 No. 10	50	50 lbs.
C118RGAC	18.0	3 3/4" round with ground lug. 2 captive mounting nails. 4 Auto/Clamps®.	3 3/4"	3 5/32"	9 No. 14 8 No. 12 7 No. 10	50	50 lbs.
C118HAC	18.0	3 3/4" round. Bar-hanger adjusts to 16" or 24" joist spacing. 4 Auto/Clamps®.	3 3/4"	3 5/32"	9 No. 14 8 No. 12 7 No. 10	50	50 lbs.
C118HGAC	18.0	3 3/4" round with ground lug. Bar-hanger adjusts to 16" or 24" joist spacing. 4 Auto/Clamps®.	3 3/4"	3 5/32"	9 No. 14 8 No. 12 7 No. 10	50	50 lbs.

*UL Classified for 2 Hour Fire Resistance.

SLATER® PLASTIC BOXES

Tamper-Resistant Floor Box Assemblies For Wood Sub-Floors



FB1TRSRB



FB1TRDRB

Features – FB Series

- Tamper-resistant receptacles feature dual mechanical shutter system to help prevent insertion of foreign objects.
- Meets NEC 406.11 requirements.
- Rugged diecast cover plates.
- Meets UL514(c) and NEC 314.27(c).
- Scrub water compliant.
- With durable nickel or brass cover plates.
- Swing brackets mounting option eliminates drilling tile flooring for mounting screws.
- Wood sub-floors only.
- Wire Fill (AWG): 10 No. 14, 9 No. 12, 8 No. 10.

CATALOG NUMBER	CU. IN. VOL.	DESCRIPTION	COVER PLATE FINISH	DIMENSIONS (IN.)			QTY. PER CARTON
				L	W	D	
FLOOR BOX ASSEMBLIES — ONE GANG FOR WOOD SUB-FLOORS							
FB1TRSRB FB1TRSRN	20.5	Single threaded screw plug. Includes 15A, 125V single tamper-resistant receptacle.	Brass Nickel	4¾	3¾	4	1
FB1TRDRB FB1TRDRN	20.5	#8 duplex opening, 2 threaded screw plugs. Includes 3232 tamper-resistant 15A, 125V duplex receptacle.	Brass Nickel	4¾	3¾	4	1

National Electrical Code® Section 406.11 Tamper-Resistant Receptacles in Dwelling Units.

In all areas specified in 210.52 all 125-volt, 15- and 20-amp receptacles shall be listed tamper-resistant receptacles.

SLATER® PLASTIC BOXES

Tamper-Resistant Floor Box Assemblies For Wood Sub-Floors

FB2TRDRKS4N Floor Box Assemblies

- A. Rugged, die-cast cover plate** with durable nickel or brass finish.
- B. Large box flange** rests on finished floor — no adjustments needed.
- C. Swing-bracket mounting**, great for tile floors — eliminates drilling for mounting screws.
- D. Dual-voltage models available.** Includes 15 Amp, 125 Volt tamper-resistant duplex receptacle, low-voltage divider, Cat 5e jack, F-connector, and blanks.
- E. Extra-deep design** leaves plenty of wiring room.

Scrub water compliant without caulking, supplied with foam gasket and O-ring-equipped plugs.

Meets NEC Section 406.11 Tamper-Resistant requirements.

Meet UL514C and NEC314.27c requirements including scrub water for tile floors.

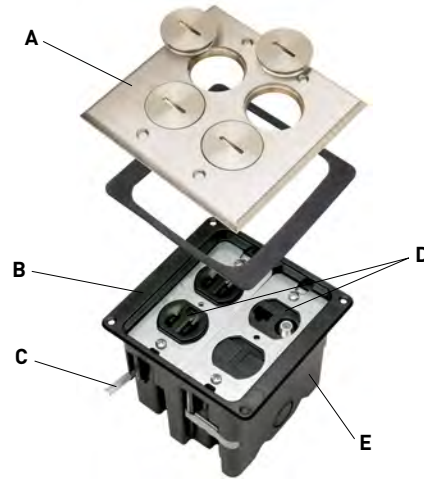

CATALOG NUMBER	CU. IN. VOL.	DESCRIPTION	COVER PLATE FINISH	DIMENSIONS (IN.)			QTY. PER CARTON
				L	W	D	
FLOOR BOX ASSEMBLIES — TWO GANG FOR WOOD SUB-FLOORS							
FB2TRDR2B FB2TRDR2N	42.5	Two #8 duplex openings, 4 threaded screw plugs. Includes two 3232 tamper-resistant 15A, 125V duplex receptacles.	Brass Nickel	4¾	6½	4	1
FB2TRDRKS4B FB2TRDRKS4N	42.5	Dual-voltage. Two #8 duplex openings, 4 threaded screw plugs. Includes 3232 tamper-resistant 15A, 125V duplex receptacle, Cat 5e jack, F-connector, 10 blanks & low-voltage divider.	Brass Nickel	4¾	6½	4	1

Wire File (AWG): 21 No. 14, 18 No. 12, 17 No. 10.

SLATER® PLASTIC BOXES

Tamper-Resistant Round Floor Box Assemblies For Wood or Concrete Sub-Floors



PS862TRT



PS862TRGFICAL

Features

- Tamper-resistant receptacles feature dual mechanical shutter system to help prevent insertion of foreign objects.
- Meets NEC 406.11 requirements.
- Rugged diecast cover plates.
- Brass or aluminum.
- Smooth, nearly flush installation.
- PS862 Series wood or concrete sub-floors only.
- Wire Fill (AWG): 11 No. 14, 9 No. 12, 8 No. 10.

CATALOG NUMBER	CU. IN. VOL.	DESCRIPTION	COVER PLATE FINISH	DIMENSIONS (IN.)		QTY. PER CARTON
				DIA.	DEPTH	
ROUND FLOOR BOX ASSEMBLIES FOR HARDWOOD OR TILE FINISHED FLOORS						
PS862TRT PS862TRTAL	22.0	#8 duplex opening, 2 flip lids. Includes 3232 tamper-resistant 15A, 125V duplex receptacle.	Brass Aluminum	4¼	¾	1
PS862TRTGFI PS862TRTG FIAL	22.0	#26 opening, flip lid. Includes 1595 tamper-resistant 15A, 125V duplex GFCI receptacle.	Brass Aluminum	4¼	¾	1
ROUND FLOOR BOX ASSEMBLIES FOR CARPETED FINISHED FLOORS						
PS862TRC PS862TRCAL	22.0	#8 duplex opening, 2 flip lids. Includes 3232 tamper-resistant 15A, 125V duplex receptacle.	Brass Aluminum	5½	¾	1
PS862TRGFIC PS862TRGFICAL	22.0	#26 opening, flip lid. Includes 1595 tamper-resistant 15A, 125V duplex GFCI receptacle.	Brass Aluminum	5½	¾	1

SLATER® PLASTIC BOXES

Tamper-Resistant Round Floor Box Assemblies & Covers For Wood Sub-Floors



PS863TRC



PS863TRGFIC

Features

- Tamper-resistant receptacles feature dual mechanical shutter system to help prevent insertion of foreign objects.
- Meets NEC 406.11 requirements.
- Rugged diecast cover plates.
- Brass or aluminum.
- Dual-voltage.
- Smooth, nearly flush installation.
- PS863 series wood sub-floors only.
- Includes Cat 5e & F-Connector.
- Wire Fill (AWG): 11 No. 14, 10 No. 12, 9 No. 10.

CATALOG NUMBER	CU. IN. VOL.	DESCRIPTION	COVER PLATE FINISH	DIMENSIONS (IN.)		QTY. PER CARTON
				DIA.	DEPTH	
ROUND FLOOR BOX ASSEMBLIES						
PS863TRC PS863TRCAL	23.5	Dual-voltage. #8 duplex opening, 2 flip lids and 2 low-voltage openings. Includes 3232 tamper-resistant 15A, 125V duplex receptacle, Cat 5e jack and F-connector.	Brass Aluminum	5¾	3½	1
PS863TRGFIC PS863TRGFICAL	23.5	Dual-voltage. #26 opening, flip lid and 2 low-voltage openings. Includes 1595 tamper-resistant 15A, 125V duplex GFCI receptacle, Cat 5e jack and F-connector.	Brass Aluminum	5¾	3½	1

SLATER® PLASTIC BOXES

Tamper-Resistant Floor Box Assemblies 2 Pole, 3 Wire Grounding 15A, 125V

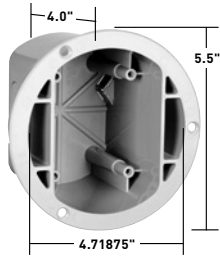

TM1542BOX



TM1542TRLA

See available colors below.

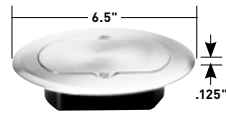

TM1542TRFM

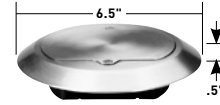

TM1542TRCF

Features

- Tamper-resistant receptacles feature dual mechanical shutter system to help prevent insertion of foreign objects.
- Meets NEC 406.11 requirements.
- Hinged door is removable and easily replaceable.
- Durable construction, impact and scratch resistant PVC construction.
- Standard Decorator opening that accepts GFCI, TVSS, DataCom or other Decorator devices.
- Auto/Clamps® and knockouts on both sides of box.
- Meets UL514(c) scrub water exclusion test.
- Threaded device mounting holes.
- Simple mounting box, fits into a 4-3/4" hole and mounts with 3 screws included.
- Ready for low-voltage wiring, drill guides on underside of cover.
- UL and cUL Listed.
- Captive screws on TM1542 series – screws will not be lost – new.
- Made in USA.

CATALOG NUMBER	DESCRIPTION	COLOR	NEMA CONFIG. NO.
FLOOR BOX			
TM1542BOX	38 cu. in., with knockouts and Auto/Clamps®, 3 screws for mounting to floor.	Gray	5-15R
THERMOPLASTIC COVERS			
TM1542TRW TM1542TRBR TM1542TRGRY TM1542TRLA	Includes 15A, 125V tamper-resistant Decorator receptacle, matching detachable and replaceable hinged door; threaded device-mounting holes; drill guides for low-voltage poke-through holes; accepts any Decorator device; mounts on carpeting, hardwood, linoleum, tile floors; 4 mounting/leveling screws.	White Brown Paintable Gray Light Almond	5-15R 5-15R 5-15R 5-15R
BRASS COVERS			
1542TRFM	Low-profile cover requires minimum 3/8" hardwood floor thickness.	Brass	5-15R
TM1542TRCF	High-profile cover fits any floor finish – including carpeting, linoleum, tile, etc. Both covers include an 885 tamper-resistant 15A, 125V Decorator duplex receptacle and will accept any Decorator device. Covers include captive screws to prevent loss.	Brass	5-15R

UL listed in accordance with 314.27(e).

Features

- Solid brass covered plate with matching flush fitting brass cap.
- 15A, 125V single receptacle made of durable thermoplastic.
- UL and FSUL listed.

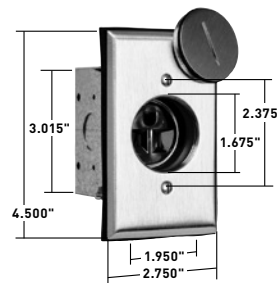

1542TRFBA

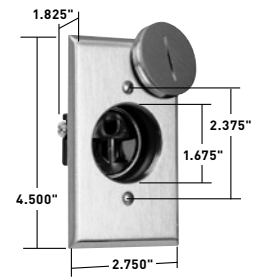

1542TRDR

CATALOG NUMBER	RATING		DESCRIPTION	COLOR	NEMA CONFIG. NO.
	A.	V.			
FLOOR BOX ASSEMBLY**					
1542TRFBA	15	125	Tamper-resistant receptacle, brass plate, 1.01" recessed plug, gasket, O-ring, and metal 18 cu. in. box	Brown	5-15R
DISPLAY RECEPTACLE*					
1542TRDR	15	125	Tamper-resistant receptacle, brass plate and 1.01" recessed plug	Brown	5-15R

*UL listed in accordance with 314.27(e).

**Conforms to NEMA OS2.

All devices listed on this page conform to NEMA OS2.

SLATER® PLASTIC BOXES

Recessed TV Boxes



TV3WTVSSW

Ideal for flat-screen TVs, home office, kitchen counter tops, and behind furniture to allow snug-to-wall placement.

Today's homeowners have more multimedia choices than ever — including flat panel, wall-mounted televisions. P&S Recessed TV Boxes offer a clean installation with the versatility to handle up to 12 multimedia connections, while providing surge protected power.

Their recessed design saves space and simplifies connections to cable or satellite boxes, DVRs, DVD players, surround-sound systems and more.

And they're available with or without surge protective receptacles to protect costly electronics from potentially damaging surges.



TV1WW



TV1WTVSSBK



TV2MW



TV1WMLVKITWCC2

Features

- Clean, flush-mount appearance — snap-on end caps hide mounting screws.
- Flexible — position either line voltage or low-voltage in all three openings.
- Low-voltage connectors offer both terminated and pull-through capability.
- Plugs and multimedia connections stay recessed behind the wall surface.
- Molded-in template and rectangular cut-out.
- Accepts standard TP wall plates.
- Metal swing brackets ensure a solid mounting.
- Uses old-work-style boxes for line voltage.
- Accepts all P&S keystone low-voltage connectors, including Cat 5e and F-connectors (both supplied with Surge Protective kit), as well as RCA and audio binding posts.
- Metal boxes feature all-steel construction and are ideal for commercial applications.

CATALOG NUMBER	DESCRIPTION	COLOR
RECESSED TV BOXES		
TV1WW TV1WBK TV1WLA	Single Gang Recessed TV Box — Frame Only.	White Black Light Almond
TV1WTVSSW TV1WTVSSBK TV1WTVSSLA	Single Gang Recessed TV Box with Surge Protective and Low-Voltage Kit. Includes Surge Protective Duplex Receptacle, Cat 5e Jack, F-Connector, Blanks, and Wall Plates.	White Black Light Almond
TV3WW TV3WBK TV3WLA	Three Gang Recessed TV Box — Frame Only.	White Black Light Almond
TV3WTVSSW TV3WTVSSBK TV3WTVSSLA	Three Gang Recessed TV Box with Surge Protective & Low-Voltage Kit. Includes Surge Protective Duplex Receptacle, Cat 5e Jack, F-Connector, Blanks, and Wall Plates.	White Black Light Almond

Single gang dimensions: 7.25" L x 4.875" W x 2.25" D
 Three gang dimensions: 8.5" L x 4.875" W x 2.25" D

CATALOG NUMBER	CUBIC INCH VOLUME	DESCRIPTION	L	W	D	WIRE FILL (AWG)
METAL RECESSED TV BOXES						
TV1WMTVSSWCC2	18	Single Gang Recessed TV Box with metal electrical box, White	8	5	3.5	17 #14; 15 #12; 14 #10
TV1WMLVKITWCC2	18	Single Gang Recessed TV Box with metal electrical box and low-voltage brush, White	8	5	3.5	17 #14; 15 #12; 14 #10
TV2MW	37.5	Two Gang Commercial Metal Recessed TV Box, White	6.9	7.6	3.5	9 #14; 8 #12; 7 #10
TV3WMTVSSW	18	Three Gang Recessed TV Box with metal electrical box, White	8	5	3.5	17 #14; 15 #12; 14 #10

SLATER® PLASTIC BOXES

SLATER® PLASTIC BOXES

Applications & Product Features

Application

Slater Plastic Boxes, the Contractor's Choice designed with unique labor-saving features, include a complete range of wall, ceiling, and old work boxes for commercial and residential construction applications.

UL Classified

All Slater Plastic Boxes are Underwriters Laboratories Listed. Slater Plastic Boxes shown that are UL Classified for Fire Resistance meet the requirements of UL263 and have a two hour fire resistance rating. These boxes may be used in fire resistant walls and ceilings. Installation information for Slater Plastic Boxes Classified for Fire Resistance may be found in the UL Fire Resistance Directory under category CEYY for Legrand.



Product Features – Exclusive Auto/Clamp®

Eliminates the need for separate cable clamps as well as the tools usually needed for installation.

Auto/Clamp® is available on all multigang boxes, old work boxes, 4" square boxes, and 3-1/4" and 4" round ceiling boxes. A major installation advantage with Auto/Clamp® is that the clamp is molded as an integral part of the box (there are no separate clamps and screws to install, adjust or tighten). Each cable opening contains an Auto/Clamp®, therefore, the non-metallic sheathed cable may be inserted where needed or where most convenient. Auto/Clamp® does not take up as much room as conventional clamps, allowing more room for wire and devices – another important feature.

To install the cable, insert stripped or unstripped non-metallic wire into the Auto/Clamp® opening and pull through to the desired length. The cable is automatically secured and the installation is complete. There are no other operations for the electrician to perform. Contractors can look forward to saving time and money with every Auto/Clamp® plastic box installation.

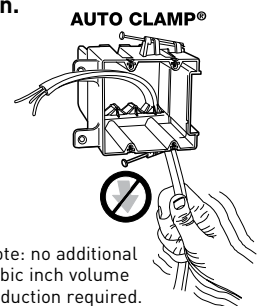

Location Ribs

Location Ribs enable the installer to quickly and accurately maintain a 1/2" offset. Dual ribs also make it easy to keep the face of the box parallel to the stud. The ribs are .450" long to reduce the chance of the box protruding beyond the 1/2" sheetrock. They project .080" to span the rounded edges of wood studs but will not cause excessive canting of the box when used with thinner wallboard.

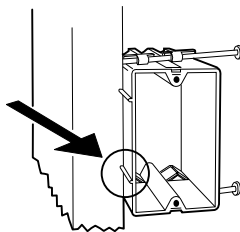

Quick/Entry®

Speeds installation by eliminating need for tools

Another time-saving idea is Quick/Entry®, a method that allows you to push stripped or unstripped non-metallic cable into a single gang plastic box without removing knock-outs. Jagged edges usually formed in other boxes are eliminated. Staple wire to stud within 8" of the box (per NEC 314.17(c)) to complete installation.

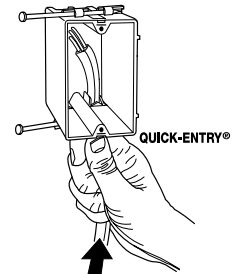

Quick/Click®

Fast, easy, and secure installations.

The unique, labor-saving Quick/Click® design secures the wiring device quickly and easily. Simply push in the mounting screws with a screwdriver and turn the screw one turn.

With Quick/Click® you cannot cross-thread or strip a device mounting screw.

Wall boxes are tested for a minimum 100 lb. total device pull-out resistance.

How Quick/Click® Works

The **spring steel** insert for quick mounting of switches and receptacles is a unique patented feature. (Refer to illustration.) Note how the spring acts as a locking ratchet and allows the screw to be pushed in and then tightened. The screw can only be released by unscrewing it in the conventional fashion.

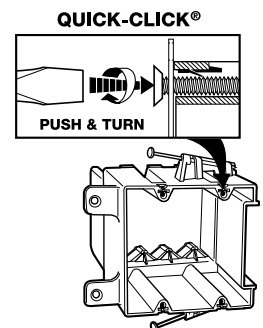
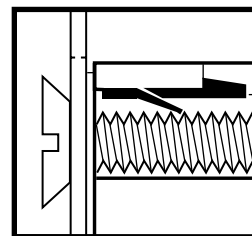

SLATER® PLASTIC BOXES

Applications & Product Features

Wood & Steel Stud Bracket Boxes – Application

Single, two, three, four gang and 4" square wood and steel stud boxes feature Quick/Click®, the labor-saving device that assures quick and dependable installation of switches and receptacles. These high-impact thermoplastic boxes can be mounted quickly to steel or aluminum studs using the CT-1 Crimping Tool. They can also be mounted to wooden studs with common nails or screws.

On the single, two, three and four gang steel stud boxes, a steel mounting bracket is provided for mounting to the structural stud. The non-mounting side of the two and four gang box has provisions for attachment to a short section of stud (phantom stud), as shown in the illustration below, to give additional rigidity to the installation. This assembly may also be used without the phantom stud as a positioning tab to automatically realign the box to the wallboard surface. The brackets are 3/8" offset to accommodate 3/8" to 5/8" thick wallboard.

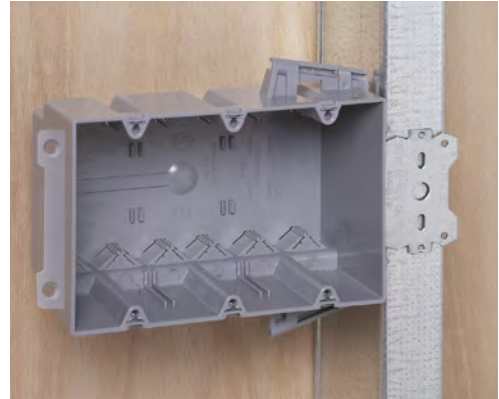

Features

- Available in single, two, three, four gang and 4" square boxes. Two, three and four gang boxes and 4" square include exclusive Auto/Clamp® feature.
- Single gang include Quick/Entry® feature.
- Quick/Click® feature offers fast and dependable installation of devices (single, two, three and four gang).
- Unique offset tab assures proper alignment to wall face. Available with 3/8" offsets.
- Can be used for steel, aluminum, or wooden studs. Can be installed on steel studs with most standard crimping tools in addition to CT-1 Crimping Tool.
- Molded of high-impact thermoplastic.

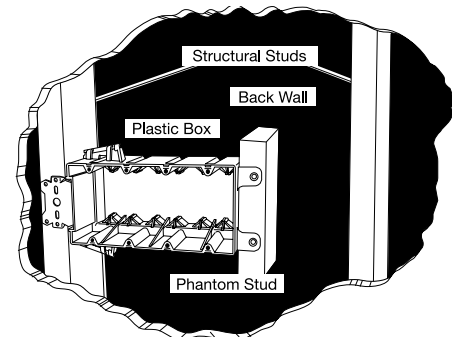

Screw Mount: Steel Stud Boxes – Application

Single, deep single, two, three, four gang, and 4" round ceiling boxes come with combination Hex/Phillips washer head screws. They are designed to save labor and speed installation in steel stud construction. These innovative boxes are an alternative to bracket boxes, and can also be used on wood studs. The specially designed drill point on the screw rapidly penetrates medium gauge steel studs to securely fasten the box. Locator ribs 0.450" long help align the box on the stud and insure correct mounting depth.

Features

- Available in single, single deep, two, three and four gang, and 4" round ceiling boxes.
- All multi-gang and ceiling boxes include exclusive Auto/Clamp® feature.
- Single gang include Quick/Entry® feature.
- Specially designed drill point rapidly penetrates medium gauge steel studs.
- Screws have combination Hex/Phillips washer heads.
- Quick/Click® feature on wall boxes offers fast and dependable installation of devices.
- Can be used for steel, aluminum, or wood studs.
- Molded of high-impact thermoplastic.
- Locator ribs ensure proper alignment on stud and proper offset depth.

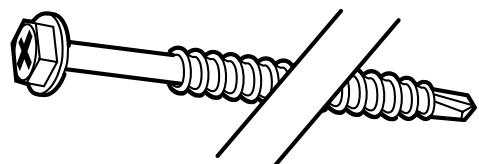

SLATER® PLASTIC BOXES

Applications & Product Features

Old Work Boxes

Application

Old Work Boxes provide fast, easy installation of an electrical device in a finished (dry walled) area where no box existed before. Old Work Boxes include the Auto/Clamp® and Quick/Click® features for convenient, labor-saving installations.

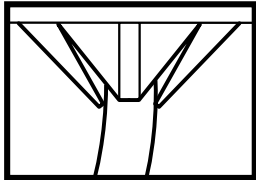

Features

- Box designed so mounting strap of the device, with plaster ears removed, fits flush, allowing use of standard depth wall plate without unsightly gap between plate and wall surface.
- Swing out wing brackets permit installation of box in wall with 1-1/4" thick wallboard down to 1/8" thick paneling.
- New longer swing brackets have greater reach to clamp onto oversized cutouts.
- Made of high impact thermoplastic.
- Combination slotted/Phillips head swing bracket screws.
- Include exclusive Auto/Clamp® feature.
- Wall boxes include exclusive Quick/Click® feature.
- Available in ceiling box versions.

Box Volume Required

TOTAL CONDUCTOR FILL COUNT	CUBIC INCHES REQUIRED FOR		
	#14 WIRE	#12 WIRE	#10 WIRE
1	2.0	2.25	2.50
2	4.0	4.50	5.00
3	6.0	6.75	7.50
4	8.0	9.00	10.00
5	10.0	11.25	12.50
6	12.0	13.50	15.00
7	14.0	15.75	17.50
8	16.0	18.00	20.00
9	18.0	20.25	22.50
10	20.0	22.50	25.00
11	22.0	24.75	27.50
12	24.0	27.00	30.00
13	26.0	29.25	32.50
14	28.0	31.50	35.00
15	30.0	33.75	37.50
16	32.0	36.00	40.00
17	34.0	38.25	42.50
18	36.0	40.50	45.00
19	38.0	42.75	47.50
20	40.0	45.00	50.00

In addition to counting 1 conductor fill allowance for each conductor, 1 additional allowance must be counted for all cable clamps, and 1 additional allowance for all ground conductors. 2 additional fill allowances must be counted for each device strap. See NEC Section 314.16(b). The table above defines box volume required for resulting total conductor fill count, depending on AWG used.

Standard Mounting Dimensions for Boxes

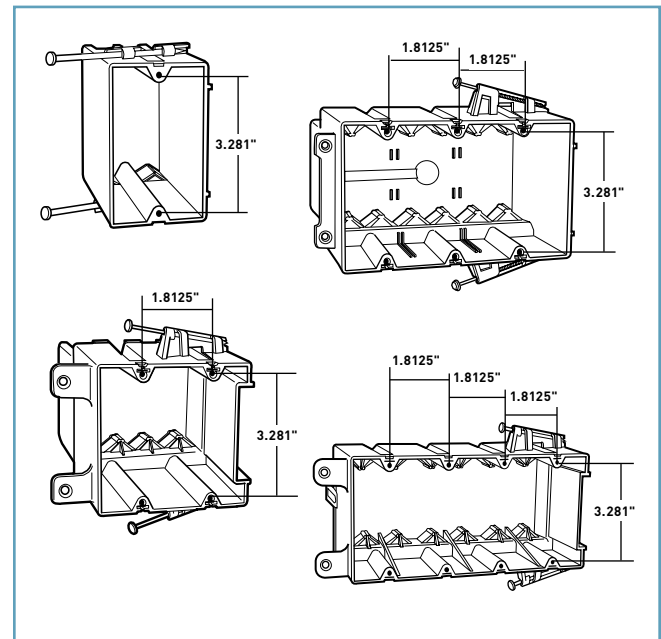

Standard Mounting Dimensions Round Boxes

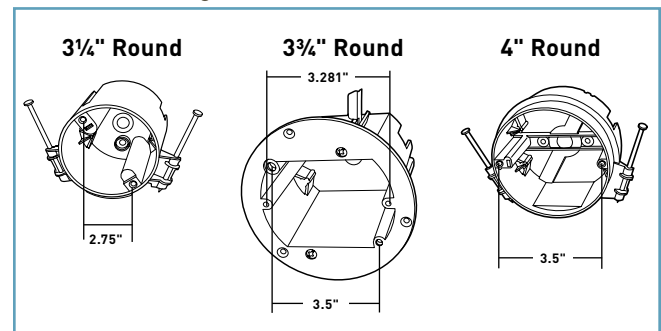

SLATER® PLASTIC BOXES

P-22

REIKER CEILING FAN & FIXTURE SUPPORT PRODUCTS



Featured Products	 <p>RETROFIT BRACES</p> <p>Q-2</p>	 <p>NEW CONSTRUCTION SLIDES</p> <p>Q-3</p>	 <p>SPECIALTY BOXES</p> <p>Q-5</p>
--------------------------	--	---	--

Retrofit Braces	Q-2
New Construction Slides	Q-3
Side, Direct & Shallow Boxes	Q-4
Specialty Boxes, Concrete Fan Support Boxes & Contractor Packs	Q-5
Specifications	Q-6



CONCRETE FAN SUPPORT BOX

Q-5

REIKER CEILING FAN & FIXTURE SUPPORT PRODUCTS

REIKER CEILING FAN & FIXTURE SUPPORT PRODUCTS

Retrofit Braces

22200 Retrofit Braces

- A. Cast zinc self-leveling feet** ease installation.
 - B. 25 cu. in. metal box** included.
 - C. Heavy-duty hexagon brace expands from 16"-24"**, perfect for existing ceiling applications.
 - D. Rotating dual supports** accept both fan (#10-32 screws) and fixture (#8-32 screws) mounting.
- Supports fans up to 70 lbs. and fixtures up to 150 lbs.**

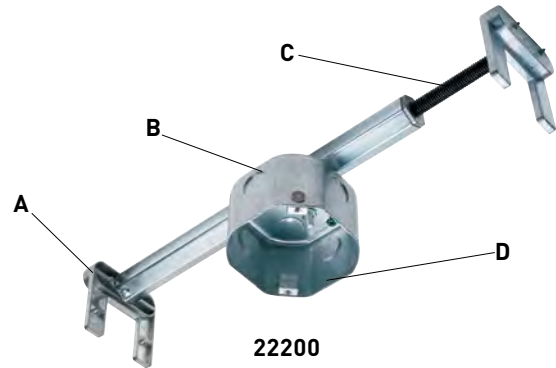

Features

- For spans from 16 to 24 inches.
- UL listed for fan and fixture support.
- Self-leveling feet.
- Maximum weight rating shown for 16" spans.
- Ground screw pre-installed.
- Boxes include top knockouts.

CATALOG NUMBER	DESCRIPTION	VOLUME CU. IN.	BOX DEPTH	QUANTITY PER CARTON	UL LISTED MAX. WEIGHT RATING AT 16" SPAN	
					FAN	FIXTURE
RETROFIT BRACES						
22200	Fan Brace – premium grade with deep box, rotating dual support for 16-24" spans	25 cu. in.	2.5"	12	70 lbs.	150 lbs.
33310	Fan Brace – standard grade with standard box, single #10 support for 16-24" spans	16 cu. in.	1.5"	12	70 lbs.	150 lbs.
33300	Fan Brace Only – use with standard octagon electrical box (33303), single #10 support for 16-24" spans	N/A	N/A	12	70 lbs.	150 lbs.
83300	Fan Brace – premium grade with standard box, rotating dual support for 16-24" spans	16 cu. in.	1.5"	12	70 lbs.	150 lbs.

REIKER CEILING FAN & FIXTURE SUPPORT PRODUCTS

New Construction Slides

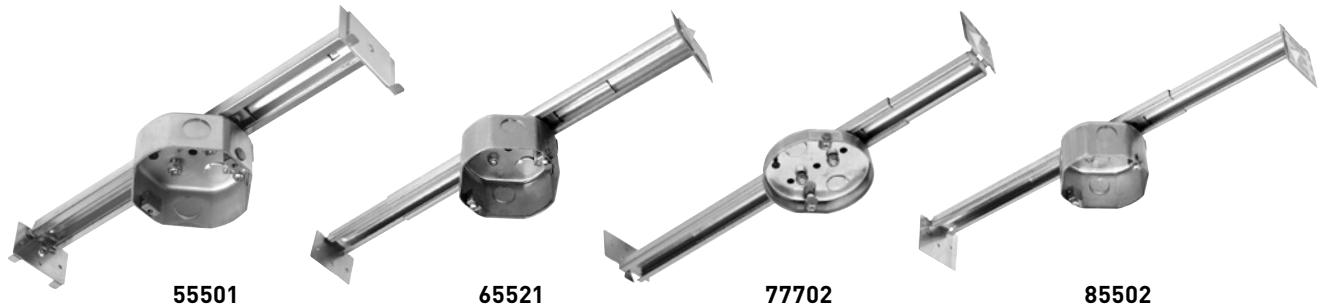

Features

- For spans from 16 to 24 inches.
- UL listed for fan and fixture support.
- Peel-off tape for "hands-free" installation.
- Maximum weight rating shown for 16" spans.
- Broadest line available, from shallow to deep boxes.
- Pre-assembled with ground screw installed.
- Boxes include top knockouts.

CATALOG NUMBER	DESCRIPTION	VOLUME CU. IN.	BOX DEPTH	QUANTITY PER CARTON	UL LISTED MAX. WEIGHT RATING AT 16" SPAN	
					FAN	FIXTURE
NEW CONSTRUCTION						
55501*	Slide Fan Support – heavy-duty slide with standard box, rotating dual support for 16-24" spans	16 cu. in.	1.5"	24	70 lbs.	110 lbs.
65521	Slide Fan Support – same heavy-duty slide as 55501, but with 2.0" deep box, to accommodate up to 1" firewall or soundproofed ceilings, with rotating dual support for 16-24" spans, bulk packed	21 cu. in.	2.0"	25	70 lbs.	110 lbs.
85502	Slide Fan Support – heavy-duty slide with deep box, rotating dual support for 16-24" spans	21 cu. in.	2.0"	24	70 lbs.	110 lbs.
77702	Slide Fan Support – heavy-duty slide with shallow box, rotating dual support for 16-24" spans	8 cu. in.	5/8"	24	70 lbs.	110 lbs.

*Available in 12 Pack. Use Catalog Number 5550112.

REIKER CEILING FAN & FIXTURE SUPPORT PRODUCTS

Side, Direct & Shallow Boxes

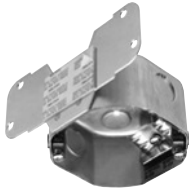
55025

77705

Features

- Direct mount to joist.
- UL listed for fan and fixture support.
- Peel-off tape for "hands-free" installation.
- Broadest line available, from shallow to deep boxes .
- Ground screw pre-installed.
- Supplied with hardware.
- Boxes include top knockouts.

CATALOG NUMBER	DESCRIPTION	VOLUME CU. IN.	BOX DEPTH	QUANTITY PER CARTON	UL LISTED MAX. WEIGHT RATING AT 16" SPAN	
					FAN	FIXTURE
SIDE MOUNT BOXES						
55015	Side Mount Box – with rotating dual support	16 cu. in.	1.5"	24	70 lbs.	150 lbs.
55020*	Side Mount Deep Box – with rotating dual support	21 cu. in.	2.0"	24	70 lbs.	150 lbs.
55025	Side Mount Deep Box – same as 55020 with 5 top knockouts and rotating dual support	21 cu. in.	2.0"	24	70 lbs.	150 lbs.
DIRECT MOUNT BOXES						
33303	Standard Electrical Box – for use with 33300 Brace	16 cu. in.	1.5"	36	N/A	N/A
44400	Direct Mount Deep Box — with rotating dual support	25 cu. in.	2.5"	24	70 lbs.	150 lbs.
55528	Direct Mount Deep Box – with rotating dual support	21 cu. in.	2.0"	24	70 lbs.	150 lbs.
SHALLOW BOXES						
77700	Direct Mount Shallow Box — with rotating dual support	8 cu. in.	5/8"	24	70 lbs.	150 lbs.
77705	Direct Mount Shallow Box — with rotating dual support	6.5 cu. in.	1/2"	24	70 lbs.	150 lbs.

*Available in 12 Packs. Use Catalog Numbers 55020012.

REIKER CEILING FAN & FIXTURE SUPPORT PRODUCTS

Specialty Boxes, Concrete Fan Support Box & Contractor Packs



77706



15010



15040

Features

- Direct mount to joist.
- UL listed for fan and fixture support.
- Peel-off tape for "hands-free" installation.
- Maximum weight rating (slides and braces) shown for 16" spans.
- Broadest line available, from shallow to deep boxes.
- Ground screw pre-installed.
- Supplied with hardware.
- Boxes include top knockouts.

CATALOG NUMBER	DESCRIPTION	VOLUME CU. IN.	BOX DEPTH	QUANTITY PER CARTON	UL LISTED MAX. WEIGHT RATING AT 16" SPAN	
					FAN	FIXTURE
SPECIALTY BOXES						
77706	Shallow Box – with wings for thick/ firewall ceilings, rotating dual support	8 cu. in.	5/8"	24	70 lbs.	150 lbs.
15010*	Drop Ceiling Support – single #10 support for 24-36" spans, 38" drop	16 cu. in.	1.5"	6	70 lbs.	150 lbs.
CONCRETE FAN SUPPORT BOX						
15040	Concrete Box – single #10 support	47.5 cu. in.	4.0"	12	35 lbs.	50 lbs.

*UL Listed Fan/Fixture at 24" Span.

CATALOG NUMBER	DESCRIPTION	VOLUME CU. IN.	BOX DEPTH	QUANTITY PER CARTON	BASE ITEM	UL LISTED MAX. WEIGHT RATING AT 16" SPAN	
						FAN	FIXTURE
BULK – CONTRACTOR PACK							
65501*	Slide Fan Support – heavy-duty slide with standard box, rotating dual support for 16-24" spans	16 cu. in.	1.5"	25	55501	70 lbs.	110 lbs.
77708	Slide Fan Support – heavy-duty slide with shallow box, rotating dual support for 16-24" spans	8 cu. in.	5/8"	24	77702	70 lbs.	110 lbs.
55500	Direct Mount Box	16 cu. in.	1.5"	24	33303	70 lbs.	150 lbs.
65505	Direct Mount Box – with rotating dual support	16 cu. in.	1.5"	50		70 lbs.	150 lbs.
67705	Direct Mount Shallow Box – with rotating dual support	6.5 cu. in.	1/2"	50	77705	70 lbs.	150 lbs.

* Available in 24 packs. Use catalog number 6550124.

REIKER CEILING FAN & FIXTURE SUPPORT PRODUCTS

Specifications

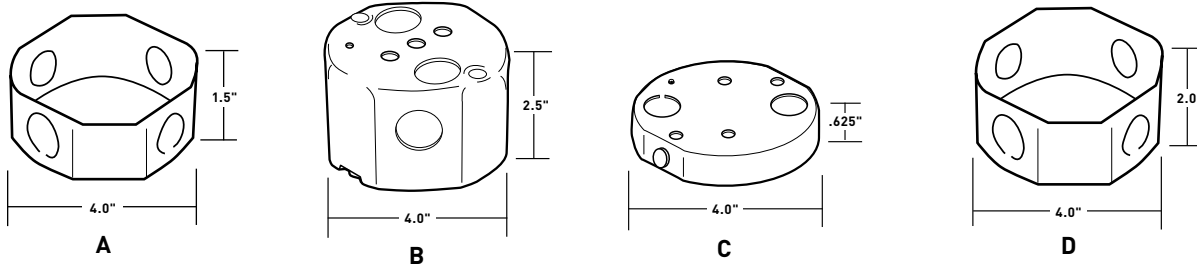

Retrofit Braces

MATERIALS OF CONSTRUCTION	
Hex Tube	16 Gauge Extruded Steel with Chrome Plating
Square Tube	16 Gauge Extruded Steel with Chrome Plating
Die Cast Feet	Die Cast Zinc
Plastic Feet	Injection Molded Plastic

COMPLIANCES
Compliant with UL514A
Compliant with NEC Section 422.18 and Section 314.27
Extension rating from 16 to 24 inches
Compliant with NEMA Standard OS1

CATALOG NUMBER	DESCRIPTION	BOX INCLUDED			WEIGHT RATING (LBS.)			
					16" SPANS		>16-24" SPANS	
		TYPE	DEPTH	CU. IN.	FAN	FIXTURE	FAN	FIXTURE
22200	Premium Brace with deep box	B	2.5	25	70	150	35	50
33300	Premium Brace only		None		70	150	35	50
33310	Standard Brace with standard box	A	1.5	16	70	150	35	50
83300	Premium Brace with standard box	A	1.5	16	70	150	35	50

New Construction Slides

MATERIALS OF CONSTRUCTION	
Slide Parts	16 Gauge Stamped Steel
Inner Slide	14 Gauge Stamped Steel

COMPLIANCES
Compliant with UL514A
Compliant with NEC Section 422.18 and Section 314.27
Extension rating from 16 to 24 inches
Compliant with NEMA Standard OS1

CATALOG NUMBER	DESCRIPTION	BOX INCLUDED			WEIGHT RATING (LBS.)			
					16" SPANS		>16-24" SPANS	
		TYPE	DEPTH	CU. IN.	FAN	FIXTURE	FAN	FIXTURE
55501	Heavy-Duty Slide with standard box	A	1.5	16	70	110	35	50
65501	Heavy-Duty Slide with standard box	A	1.5	16	70	110	35	50
65521	Heavy-Duty Slide with deep box	D	2.0	21	70	110	35	50
77702	Heavy-Duty Slide with shallow box	C	0.625	8	70	110	35	50
77708	Heavy-Duty Slide with shallow box	C	0.625	8	70	110	35	50
85502	Heavy-Duty Slide with deep box	D	2.0	21	70	110	35	50

REIKER CEILING FAN & FIXTURE SUPPORT PRODUCTS

Specifications

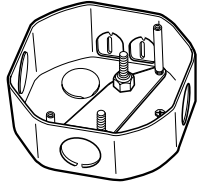

Single #10 Support

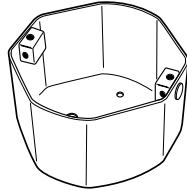

Rotating Dual Support

Side, Direct, Shallow & Specialty Boxes

MATERIALS OF CONSTRUCTION	
Box Steel	16 Gauge Stamped Steel

COMPLIANCES
Compliant with UL514A
Compliant with NEC Sections 422.18 and 314.27
Compliant with NEMA Standard OS1

CATALOG NUMBER	DESCRIPTION	BOX CAPACITY	WEIGHT RATING
33303	Electrical box only	16 cu. in.	N/A
55505	Electrical box only	16 cu. in.	Up to 70# Fan/150# Fixture
44400	Direct Mount with rotating dual support	25 cu. in.	Up to 70# Fan/150# Fixture
55015	Side Mount with rotating dual support	16 cu. in.	Up to 70# Fan/150# Fixture
55020 55025	Side Mount with rotating dual support	21 cu. in.	Up to 70# Fan/150# Fixture
55528	Direct Mount with rotating dual support	21 cu. in.	Up to 70# Fan/150# Fixture
77700	Direct Mount shallow box with rotating dual support	8 cu. in.	Up to 70# Fan/150# Fixture
77705	Direct Mount shallow box with rotating dual support	6.5 cu. in.	Up to 70# Fan/150# Fixture
77706	Direct Mount with u-bracket for firewalls with rotating dual support	8 cu. in.	Up to 70# Fan/150# Fixture

CATALOG NUMBER	WIRE CLAMP TYPE
15010	Metal
15040	Plastic
22200	Plastic
33303	Metal
55505	Metal
33310	Plastic
44400	Plastic
55015	Metal
55020	Plastic
55025	Plastic
55501	Metal
55528	Plastic
65501	Metal
65521	Metal
77700	Plastic
77702	Plastic
77705	Plastic
77706	Plastic
83300	Plastic

WEATHERPROOF BOXES & COVERS



We offer a complete line of durable, easy-to-install, and environment-resistant weatherproof products — for first-rate performance in worst-case applications.

Featured Products	 <p>INDUSTRIAL GRADE WEATHERPROOF COVERS</p> <p>R-12</p>	 <p>WHILE-IN-USE COVERS</p> <p>R-2</p>	 <p>THERMOPLASTIC COVERS</p> <p>R-9</p>
--------------------------	---	--	--

While-In-Use Covers	R-2	Weatherproof Round Boxes & Kits	R-19
Cast Weatherproof Covers	R-5	Cluster & Blank Covers	R-20
Thermoplastic Covers	R-9	Lighting Accessories & Swimming Pool Junction Box	R-21
Heavy Cast Aluminum Covers	R-12	Gaskets & Accessories	R-22
Weatherproof Stainless Steel Covers	R-14	NEC Compliance	R-23
Cast Weatherproof Boxes & Covers	R-15		
Weatherproof Boxes	R-16		

WEATHERPROOF BOXES & COVERS

WPG1 and WPG2 Thermoplastic/Heavy Cast Aluminum Covers

Two sizes: 1.96" and 2.32" diameters to cover 15A/20A Straight Blade and 15A/20A/30A Turnlok® devices. Covers fit all competitive flanged inlets and outlets.

Stainless steel mounting screws resist corrosion.

- A. Pre-attached gaskets** for easy installation and tight seal to panel or weatherproof box — with no misaligned or collapsed gaskets.
- B. Tamper-proof hinge** features permanent, locked-in pins for added security.
- C. Unbreakable glass-filled polycarbonate construction** withstands years of job site abuse and harsh environmental exposure. Stainless steel mounting screws resist corrosion.
- D. Molded-in label area** for pre-printed or handwritten labels identifying circuits, ratings, and other data.
- E. Lockable "bullnose"** for OSHA Lockout/Tagout compliance.

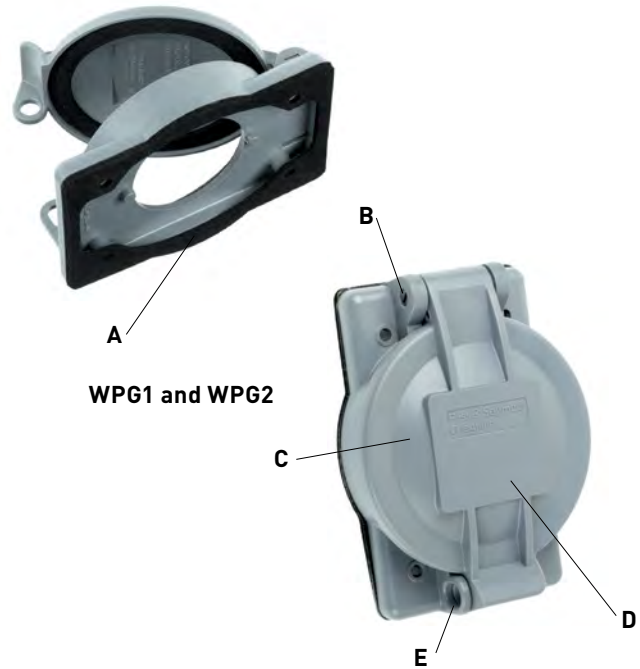

WPG1 and WPG2

WIUCED10SC Extra-Duty White-In-Use Cover

The NEC® Section 406.9(B)(1) requires that an outlet box load installed for this purpose shall be listed and shall be identified as "extra duty".

- A. Exclusive cord flap gasket** inhibits water splash from driving rain or sprinklers.
- B. Sturdy polycarbonate construction** resists impacts and harsh weather.
- C. Patented corner hinge and cord opening** allow vertical or horizontal installation.
- D. Exclusive WaterShed™ Channel** keeps water moving outside while cord flap keeps the inside dry.
- E. Preapplied gasket** easier to install, saves time, won't get lost or damaged.
- F. Paintable, textured finish** hides scratches.
- G. Patented trigger latch** opens easily with one finger, yet is lockable to prevent tampering.
- H. Sturdy, molded-in hinge** withstands hard use.
- I. Installs without removing electrical device**, thanks to patented, keyed mounting holes.
- J. Roomy interior** provides space for plugs and cord bends.

Shallow profile models have 1" shorter top lid than prior models.

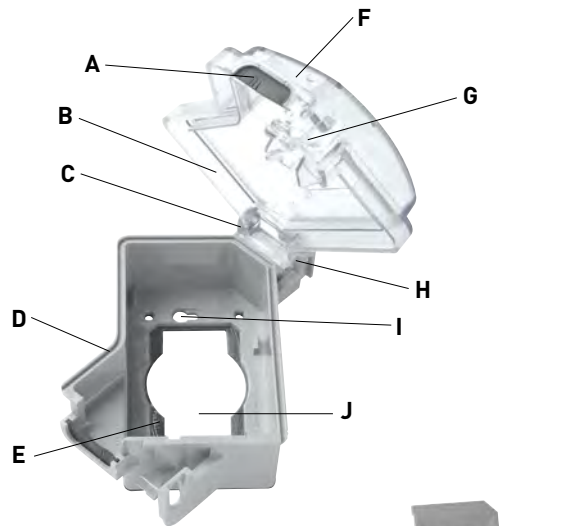

WIUCED10SC



Snap-in device plates require no tools to install and won't fall out. See chart for plates provided with each catalog number.

WEATHERPROOF BOXES & COVERS

Extra-Duty While-In-Use Covers

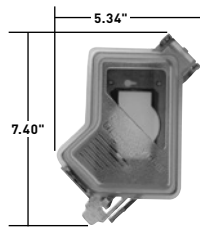

SINGLE GANG COVERS



SINGLE GANG



SINGLE GANG SHALLOW

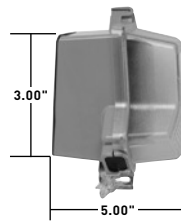

SINGLE GANG DEEP

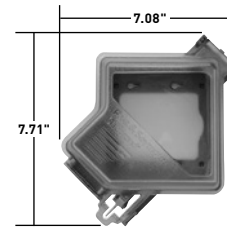

TWO GANG COVER

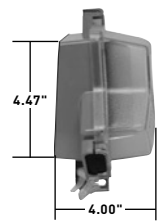

Features

- Comply with NEC® Section 406.9 (B)(1) for wet location covers, and conform to NEMA 3R.
- Covers are self-closing as required by UL514C42.3.
- Covers mount vertically or horizontally.
- Body, cover, and plates made of polycarbonate.
- Gasket made of closed cell foam, neoprene blend regular density, UL Rated HBF.
- Mounting screws made of 302 stainless steel.
- Single receptacle plate available in 1.405" and 1.595" openings.
- Deep model available for 20A locking plugs.
- Shallow covers accommodate up to 14/3 AWG extension cords.
- New trigger latch opens easily with one finger.

CATALOG NUMBER	BOTTOM COLOR	TOP COLOR	DEVICE PLATES PROVIDED	PLATE WIDTH	PACKAGE QUANTITY	3RD PARTY COMPLIANCE
						cULus
SINGLE GANG						
WIUCED10GL	Gray	Gray		2 3/8"	12	•
WIUCED10CL	Gray	Clear				
WIUCED10WL	White	White				
SINGLE GANG SHALLOW						
WIUCED10SG	Gray	Gray		2 3/8"	14	•
WIUCED10SC	Gray	Clear				
WIUCED10SW	White	White				
WIUCED10SB	White	Clear				
SINGLE GANG DEEP						
WIUCED10DGL	Gray	Gray		2 3/8"	9	•
WIUCED10DCL	Gray	Clear				
WIUCED10DWL	White	White				
TWO GANG						
WIUCED20GL	Gray	Gray		2"	8	•
WIUCED20CL	Gray	Clear				
WIUCED20WL	White	White				
EXTRA PLATE KITS						
WIUED10PK	Gray		Single Gang Plate Kit	2 3/8"		•
WIUED10PKW	White					
WIUED20PK	Gray		Two Gang Plate Kit	2"		•
WIUED20PKW	White					

WEATHERPROOF BOXES & COVERS

Extra-Duty Rating While-In-Use Covers

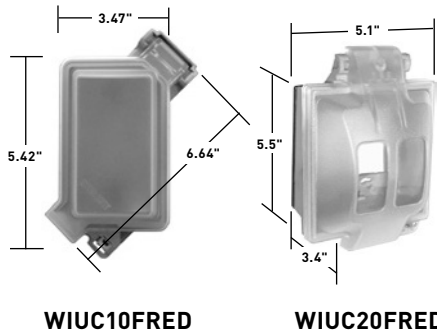

Features

- Trigger latch opens easily with one finger, yet lockable to prevent tampering.
- Pre-assembled with gasket for easier installation, saving time and preventing incorrect gasket placement.
- Frosted polycarbonate construction resists impacts and harsh weather while hiding dirt.
- Corner hinge and cord opening allows for vertical or horizontal installation (single gang only).
- Roomy interior provides space for plugs and cord bends.
- Snap-in device plates require no tools to install and won't fall out of cover, cutting installation time.

NOTE: This product complies with the 2014 NEC® section 406.9(B)(1) which requires that an outlet box load installed for this purpose shall be listed and shall be identified as "extra-duty".

CATALOG NUMBER	DESCRIPTION	COLOR	DEVICE PLATES PROVIDED
SINGLE GANG			
WIUC10FRED	In-Use Weatherproof Cover, One Gang, Extra-Duty	Frosted	GFCI, Duplex, Round
TWO GANG			
WIUC20FRED	In-Use Weatherproof Cover, Two Gang, Extra-Duty	Frosted	2 Duplex, 2 GFCI
WIUC21FRED	In-Use Weatherproof Cover, Two Gang, Extra-Duty, Single Opening in Center	Frosted	

CATALOG NUMBER	DEVICE PLATES PROVIDED	PLATE WIDTH	PACKAGE QUANTITY	3RD PARTY COMPLIANCE	
EXTRA PLATE KITS					
WIUCFR10PK	1 Toggle, 1 Power, 1 Power (1.6)		2 3/8"	10	•
WIUCFR20PK	2 Toggle, 2 Power (1.4), 2 Power (1.6)		2"	20	•

WEATHERPROOF BOXES & COVERS

Cast Weatherproof Covers

WIUCAST1

Cast Weatherproof Cover

- A. Self-closing lids** as required by UL514C42.3.
 - B. Heavy-duty die-cast aluminum.**
 - C. Exclusive cord flap gasket** inhibits water splash from driving rain or sprinklers.
 - D. Lockable cover** accepts a standard sized padlock.
 - E. Patented corner hinge** and cord opening allow vertical or horizontal installation.
 - F. Preapplied gasket** easier to install, saves time, won't get lost or damaged.
- Meets NEC® Section 406.9(B)(1)** suitable for Extra Duty wet locations.

All components baked-on electrostatic, polyester, powder paint coated prior to assembly for superior corrosion resistance.

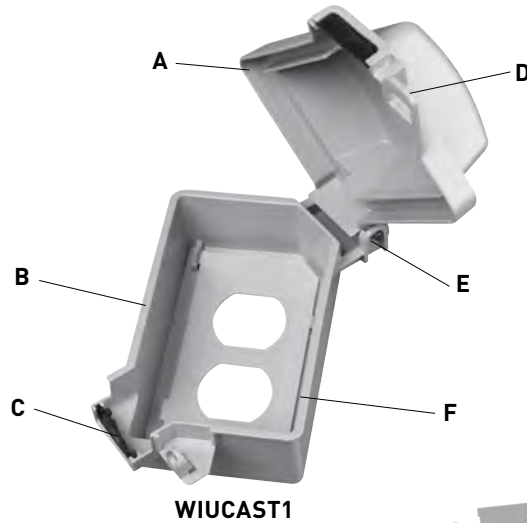

WIUCAST1

Zinc-plated screws, and three metal mounting plates are supplied.

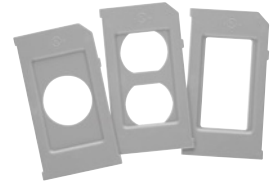

CATALOG NUMBER	COLOR	DEVICE PLATES PROVIDED	PACKAGE QUANTITY	3RD PARTY COMPLIANCE
				cUL US
SINGLE GANG				
WIUCAST1*	Gray		12	•
TWO GANG				
WIUCAST2	Gray		10	•

*WIUCAST1 accepts WIU10PK inserts (see Page R-3).

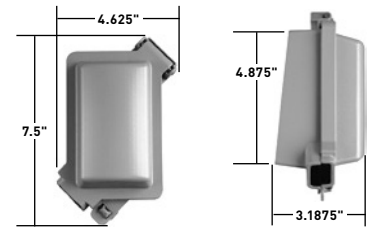

WIUCAST1

WEATHERPROOF BOXES & COVERS

Cast Weatherproof Covers

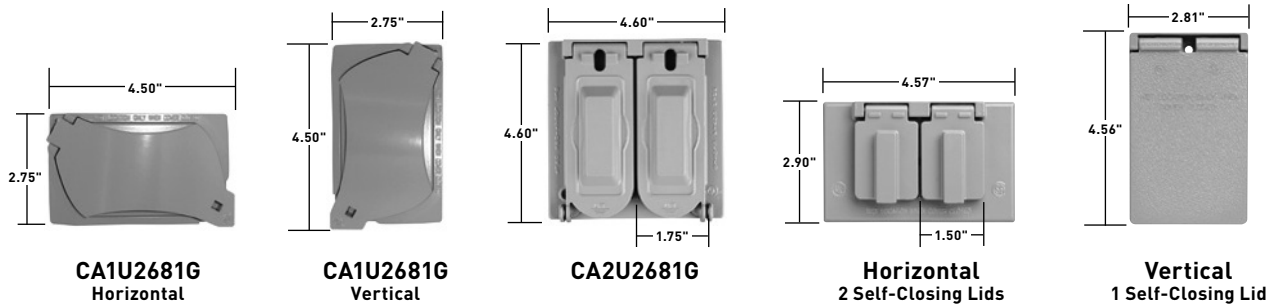

CATALOG NUMBER	DESCRIPTION	COLOR	3RD PARTY COMPLIANCE
ONE GANG			
CA7GV	Single Receptacle Vertical – 1 Self-Closing Lid	Gray	
CA8GH CA8WH	Duplex Receptacle Horizontal – 2 Self-Closing Lids	Gray White	•
CA8GJ	Oversized Duplex Receptacle Horizontal – 2 Self-Closing Lids Dimensions: H - 4.52", L - 4.58"	Gray	•
CA8GVFS CA8WV	Duplex Receptacle Vertical – 1 Self-Closing Lid 5 Screw Mounting	Gray White	
CA721G	Power Outlet – 1.625 Diameter Vertical – 1 Self-Closing Lid	Gray	•
CA723G	Power Outlet – 2.125 Diameter Vertical – 1 Self-Closing Lid	Gray	
CA8WVFS	Duplex Receptacle Vertical – 1 Self-Closing Lid 4 Screw Mounting	White	•

Features

- Featuring one and two gang universal covers.
- Broad line of one gang covers for receptacles and power outlets.
- Heavy-duty die-cast zinc. Stainless steel springs.
- Baked-on electrostatic, polyester, powder paint for superior scratch and corrosion resistance.
- Covers comply with NEC® Section 406.9(A).

CATALOG NUMBER	DESCRIPTION	COLOR	3RD PARTY COMPLIANCE
UNIVERSAL CAST WEATHERPROOF COVERS			
CA1U2681G	One Gang Cover with Metal Device Plates for #26, #8 and #1 Openings (One Each)	Gray	•
CA2U2681G	Two Gang Cover with Metal Device Plates for #26, #8 and #1 Openings (Two Each)	Gray	•

Universal Cast Weatherproof Covers

can serve six applications with a combination of inserts and one gang horizontal or vertical mounting.



WEATHERPROOF BOXES & COVERS

Cast Weatherproof Covers

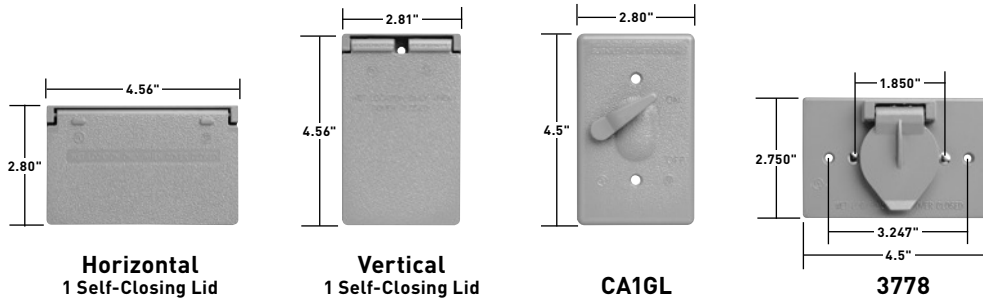

Features

- Broad line of single gang covers for switches and GFCIs.
- Baked-on electrostatic, polyester, powder paint for superior scratch and corrosion resistance.
- Heavy-duty die-cast zinc.
- Stainless steel springs.
- Covers comply with NEC Section 406.9(A).

CATALOG NUMBER	DESCRIPTION	COLOR	3RD PARTY COMPLIANCE
ONE GANG			
CA26GH CA26WH	Decorator or GFCI Horizontal – 1 Self-Closing Lid	Gray White	• •
CA26GV CA26WV	Decorator or GFCI Vertical – 1 Self-Closing Lid	Gray White	•
CA1G	Vertical – 1 Self-Closing Lid with Inserts Accommodates Toggle Switch +1.750 Power Outlet	Gray	•
CA1GS	Toggle with 15A 120VAC Single Pole Toggle Switch [Cat. # 660] Included Vertical – 1 Self-Closing Lid	Gray	•
CA1GL	Toggle Switch Cover – with Actuating Lever – Mounts Directly Over Switch	Gray	•

CATALOG NUMBER	DESCRIPTION	COLOR	3RD PARTY COMPLIANCE
SELF-CLOSING COVER – MOTOR BASE – HORIZONTAL			
3778	Single with 15A 125V Recessed Flanged Inlet.	Gray	•





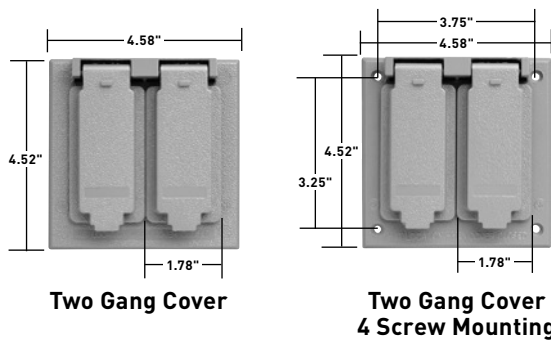







WEATHERPROOF BOXES & COVERS

Cast Weatherproof Covers



Features

- Broad line of two gang covers for switches, receptacles, GFCIs, and power outlets.
- Baked-on electrostatic, polyester, powder paint for superior scratch and corrosion resistance.
- Heavy-duty die-cast zinc.
- Stainless steel springs.
- All covers have 2 self-closing lids.
- Covers comply with NEC® Section 406.9(B)(1).

CATALOG NUMBER	DESCRIPTION	COLOR	3RD PARTY COMPLIANCE
			
TWO GANG			
CA82G CA82W	 2 Duplex Receptacles	Gray White	•
CA72G	 2 Single Receptacles	Gray	•
CA78G	 1 Single/1 Duplex 4 Screw Mounting	Gray	•
CA726G	 1 Single/1 Decorator 4 Screw Mounting	Gray	•
CA262G	 2 Decorator 4 Screw Mounting	Gray	•
CA268G	 1 Decorator/1 Duplex 4 Screw Mounting	Gray	•
CA17G	 1 Toggle/1 Single 4 Screw Mounting	Gray	•
CA18G	 1 Toggle/1 Duplex 4 Screw Mounting	Gray	•
CA126GRY	 1 Toggle/1 Decorator 4 Screw Mounting	Gray	•
CA2G CA2W	 2 Toggles 4 Screw Mounting	Gray White	•
CA2GS	 2 Toggles with 2 15A 120VAC Single Pole Toggle Switches (Cat. # 660) Included 4 Screw Mounting	Gray	•

WEATHERPROOF BOXES & COVERS

Thermoplastic Covers

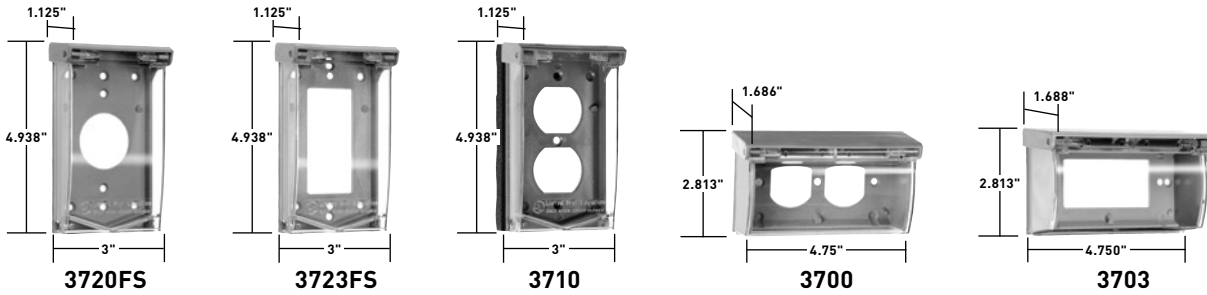

CATALOG NUMBER	DESCRIPTION	GASKET THICKNESS	3RD PARTY COMPLIANCE	
			UL	SR
SELF-CLOSING COVERS – CLEAR POLYCARBONATE LID VERTICAL TWO SCREW MOUNTING – PADLOCKABLE				
3710 3710WH	Duplex RV use Gray Base/Clear Cover White Base/White Cover	3/8"	•	•
3720 3720WH	Single Receptacle 1.40" Diameter or Toggle Switch (Toggle Switch Insert Included), Gray Base/Clear Cover White Base/White Cover	3/8"	•	•
3723 3723WH	Decorator RV use Gray Base/Clear Cover White Base/White Cover	3/8"	•	•
SELF-CLOSING COVERS – CLEAR POLYCARBONATE LID VERTICAL FOUR SCREW MOUNTING – PADLOCKABLE				
3710FS	Duplex Receptacle Gray Base	3/32"	•	•
3720FS	Single Receptacle 1.40" Diameter or Toggle Switch (Toggle Switch Insert Included), Gray Base	3/32"	•	•
3723FS	Decorator or GFCI Gray Base	3/32"	•	•
3722FS	Power Outlet, 1.60" Diameter Gray Base	3/32"	•	•
3724FS	Power Outlet, 1.73" Diameter Gray Base	3/32"	•	•
3795	Power Outlet, 2.13" Diameter Gray Base	3/8"	•	•
SELF-CLOSING COVERS – CLEAR POLYCARBONATE LID HORIZONTAL TWO SCREW MOUNTING				
3700	Duplex Receptacle Gray Base	3/32"	•	•
3703	Decorator Gray Base	3/32"	•	•
3703T	Decorator RV Use Gray Base	3/8"	•	•
3703TCW	Decorator RV Use Colonial White Base	3/8"	•	•
SELF-CLOSING COVERS – CLEAR POLYCARBONATE LID HORIZONTAL FOUR SCREW MOUNTING				
3700FS	Duplex Receptacle Gray Base	3/32"	•	•
3703FS	Decorator Receptacle Gray Base	3/32"	•	•

Features

- Broad line of single gang covers for switches, receptacles, GFCIs and power outlets.
- Clear polycarbonate lid with reinforced thermoplastic base.
- Covers comply with NEC® Section 406.9(A).

WEATHERPROOF BOXES & COVERS

Thermoplastic Covers

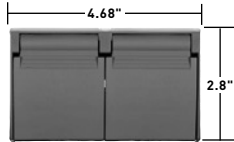



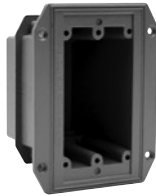







3780 Series





FBOX1

Features

- Broadest line in the industry.
- All covers are self-closing with two flip lids.
- Covers comply with NEC® Section 406.9(A).

CATALOG NUMBER	DESCRIPTION	GASKET THICKNESS	3RD PARTY COMPLIANCE	
			UL	SF
OUTDOOR ASSEMBLIES AND SPECIAL COVERS FOR MOBILE HOMES, MANUFACTURED AND MODULAR HOUSING, AND RV USE - HORIZONTAL INSTALLATION WITH TWO SELF-CLOSING FLIP LIDS				
3780SCFBX	 3232 Duplex Receptacle, Gasket and Flanged Box, Gray with Black Gasket	1/8"	•	
3780SCFBXCW	 3232 Duplex Receptacle, Gasket and Flanged Box, Colonial White with Black Gasket	1/8"	•	
3780SCFBXWH	 3232 Duplex Receptacle, Gasket and Flanged Box, White with Black Gasket	1/8"	•	
3780SCMH	 3232 Duplex Receptacle & Gasket, Gray with Black Gasket	3/8"	•	
3780SCMHCW	 3232 Duplex Receptacle & Gasket, Colonial White with Black Gasket	3/8"	•	
3780SCMHBG	 3232 Duplex Receptacle & Gasket, Beige with Black Gasket	3/8"	•	
3780SCMHWH	 3232 Duplex Receptacle & Gasket, White with Black Gasket	3/8"	•	
3780SCLV	 3/8" Round Openings for 2 Coaxial Connections, Gray with Black Gasket	1/8"	•	•
3780SCLVBG	 3/8" Round Openings for 2 Coaxial Connections, Beige with Black Gasket	1/8"	•	•
3780SCLVCW	 3/8" Round Openings for 2 Coaxial Connections, Colonial White with Black Gasket	1/8"	•	•
3780SCLVWH	 3/8" Round Openings for 2 Coaxial Connections, White with Black Gasket	1/8"	•	•

CATALOG NUMBER	DESCRIPTION	COLOR	3RD PARTY COMPLIANCE	
			UL	SF
FLANGED BOXES FOR HORIZONTAL OR VERTICAL INSTALLATION				
FBOX1	 Flanged Box - 18.5 Cubic Inch Minimum Opening Size 2.5" x 4.1" Depth 3.0"	Gray	•	
FBOX1WH	 Flanged Box - 18.5 Cubic Inch Minimum Opening Size 2.5" x 4.1" Depth 3.0"	White	•	

WEATHERPROOF BOXES & COVERS

WEATHERPROOF BOXES & COVERS

Thermoplastic Covers

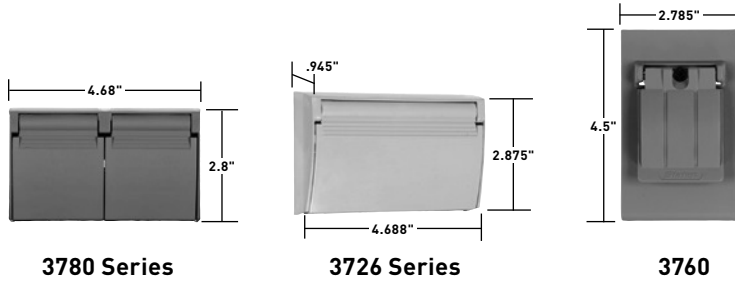

Features

- Broadest line in the industry.
- Covers comply with NEC® Section 406.9(A).
- 3780 series have two flip lids.
- 3726 series have a single flip lid.

CATALOG NUMBER	DESCRIPTION	GASKET THICKNESS	3RD PARTY COMPLIANCE	
			UL	SR
HORIZONTAL SELF-CLOSING FLIP LIDS				
3780SC	Duplex, Gray with Black Gasket	1/8"	•	•
3780SCCW	Duplex, Colonial White with Black Gasket	1/8"	•	•
3780SCWH	Duplex, White with Black Gasket	1/8"	•	•
3780SCBG	Duplex, Beige with Black Gasket	1/8"	•	•
3780SCCWT	Duplex, Colonial White with Black Gasket	3/8"	•	•
3726SC	Decorator or GFCI, Gray with Black Gasket	3/32"	•	•
3726SCBG	Decorator or GFCI, Beige with Black Gasket	3/32"	•	•
3726SCCW	Decorator or GFCI, Colonial White Black Gasket	3/32"	•	•
3726SCWH	Decorator or GFCI, White Black Gasket	3/32"	•	•
HORIZONTAL SINGLE COVER SELF-CLOSING FLIP-LID				
3770SC	Single Receptacle 1.405" Diameter, Gray	3/32"	•	•
VERTICAL SINGLE COVER THREE POSITION FLIP-LID (CLOSED, OPENED 90° OR OPENED 180°)				
3760	Single Receptacle 1.563" Diameter, Gray	3/32"	•	•
3763	Cover with 5251-I Single Receptacle, 15A-125V, Gray	3/32"	•	•
HORIZONTAL REINFORCED THERMOPLASTIC TWO POSITION FLIP-LIDS, (CLOSED OR OPENED 90°)				
3780	Duplex, Gray with Black Gasket, 2 Flip Lids	1/8"	•	•

WEATHERPROOF BOXES & COVERS

Thermoplastic/Heavy Cast Aluminum Covers Specification Grade

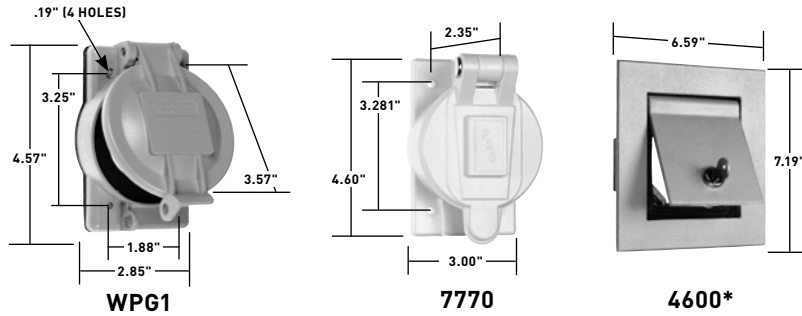

INDUSTRIAL GRADE WEATHERPROOF COVERS

Features

- Unbreakable glass-filled polycarbonate construction to withstand years of job site abuse and harsh environmental exposure. Stainless steel mounting screws also resist corrosion.
- Covers comply with NEC® Section 406.9(A).
- Molded-in label area (2.8 sq. in.) for pre-printed or handwritten labels for identification of circuits, ratings, and other application data.
- WPG1 and WPG2 have lockable "bullnose" for OSHA locktag/tagout compliance.
- Covers fit all competitive inlets and outlets.
- Pre-attached gaskets for easy installation and tight seal to panel or weatherproof box – with no misaligned or collapsed gaskets.
- Tamper-proof hinge features permanent, locked-in pins for added security.

CATALOG NUMBER	DESCRIPTION	COLOR	3RD PARTY COMPLIANCE	
			UL	SF
THERMOPLASTIC WEATHERPROOF COVERS FOR FLANGED INLET/OUTLET				
WPG1	1.96" Diameter Opening to Accommodate 15/20A Straight Blade, 15A Turnlok, 20403 Power Interrupter	Gray	•	•
WPG2	2.32" Diameter Opening to Accommodate 20A Turnlok, 30A Turnlok	Gray	•	•
THERMOPLASTIC WEATHERPROOF COVER FOR SINGLE RECEPTACLES				
7425Y	Corrosion-Resistant Flip Lid Receptacle Cover for 20/30A Turnlok®	Yellow		
7425GRY	Corrosion-Resistant Flip Lid Receptacle Cover for 20/30A Turnlok®	Gray		
7770	2.38" Diameter Opening to Accommodate 50A Turnlok (non-lockout)	Yellow	•	
7770GRY	2.38" Diameter Opening to Accommodate 50A Turnlok (non-lockout)	Gray	•	

HEAVY CAST ALUMINUM COVERS – FLUSH ENCLOSURES

Features

- Adapter, frame, and cover are heavy cast aluminum.
- No. 8-32 screws hold assembly firmly in place.
- Covers comply with NEC® Section 406.9(A).
- Mortar keys provide positive holding means within wall.
- Neoprene gasket seals cover to frame. Moisture and dust cannot enter enclosure.
- Two keys provided for lock.
- Purchase enclosure and mounting plate separately
- Mounts on 4" or 4-11/16" box.

CATALOG NUMBER	DESCRIPTION	COLOR	3RD PARTY COMPLIANCE	
			UL	SF
MORTARED-IN APPLICATIONS				
4600*	Enclosure Only, without Mounting Plate	Gray	•	•
46001P	Mounting Plate for Toggle Switch	Gray	•	•
46007P	Mounting Plate for Single Receptacle Diameter: 2.156"	Gray	•	•
46008P	Mounting Plate for Duplex Receptacle	Gray	•	•
460026P	Mounting Plate for Decorator/GFCI	Gray	•	•
4609	Replacement Key for Enclosure		•	•

*Note: All locks keyed the same.



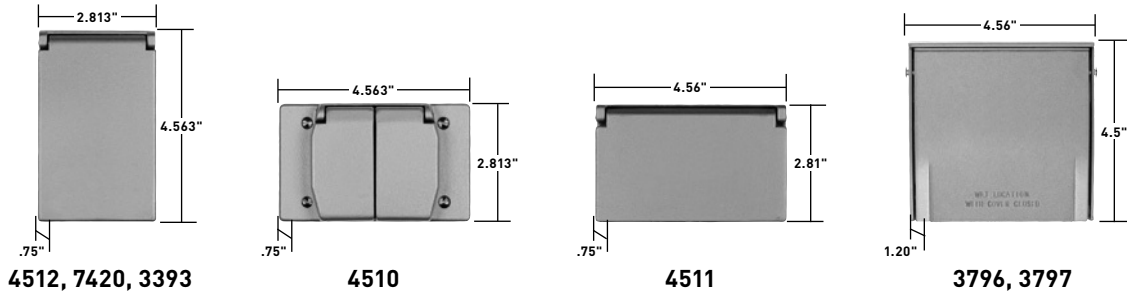

WEATHERPROOF BOXES & COVERS

Heavy Cast Aluminum Covers Specification Grade





Features

- Extremely durable for hard-use institutional applications.
- Spring-loaded covers close automatically when plugs are removed.
- Die-cast copper-free aluminum construction.
- Stainless steel springs.
- Screws and spring covers are chrome-plated brass.
- Baked-on lacquer finish.
- Heavy rubber gaskets provide positive seal.
- All covers below are for 4 screw mounting only.
- Covers comply with NEC Section 406.9(A).

CATALOG NUMBER	DESCRIPTION	COLOR	3RD PARTY COMPLIANCE	
			UL	SP
HEAVY CAST ALUMINUM COVERS – ONE GANG				
4510	 Duplex Receptacle, 2 Doors, Horizontal	Gray	•	•
4511	 Decorator/GFCI, Horizontal	Gray	•	•
4512	 Decorator/GFCI, Vertical	Gray	•	•
7420	 1 Gang Power Outlet, 1.593" max. Diameter, Vertical	Gray	•	•
3393	 1 Gang Power Outlet, 1.750" max. Diameter, Vertical	Gray	•	•

Features

- Heavy-duty die cast aluminum covers and plate.
- 3/32" gasket included.
- Stainless steel mounting screws.

CATALOG NUMBER	DESCRIPTION	COLOR	3RD PARTY COMPLIANCE	
			UL	SP
MULTIGANG COVERS – OUTDOOR				
3796	 2 Gang Power Outlet (2.156" Diameter Opening)	Gray	•	•
3797	 2 Gang Power Outlet (2.656" Diameter Opening)	Gray	•	•

WEATHERPROOF BOXES & COVERS

Weatherproof Stainless Steel Covers Specification Grade

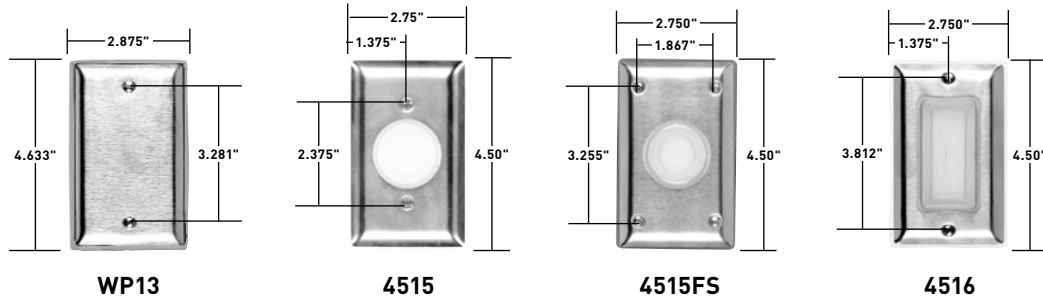

Features

- Covers comply with NEC Section 406.9(A).
- Plate is Type 302/304 Stainless Steel for corrosion resistance.
- Ideal for hard-use and corrosive applications.
- Aesthetically pleasing.

CATALOG NUMBER	DESCRIPTION	3RD PARTY COMPLIANCE	
		UL	SR
STAINLESS STEEL COVERS			
WP13 WP13FS	1 Gang Blank (Box Mounted) Gasketed For 4 Screw Mounting	•	•
WP23	2 Gang Blank (Box Mounted) Gasketed	•	•

Features

- Covers comply with NEC Section 406.9(A).
- Plate is Type 302/304 Stainless Steel for corrosion resistance.
- Transparent silicone rubber mat seals plate and opening from contamination.
- Switch easily actuated through flexible silicone bubble.
- Silicone mat maintains pliability from -100° F to +250° F.
- Mat is resistant to grease, water, steam, detergents, aging, and ozone.

CATALOG NUMBER	MAT CATALOG NUMBER	DESCRIPTION	3RD PARTY COMPLIANCE	
			UL	SR
STAINLESS STEEL COVERS				
4515	4515GAS	Round mat, mounts to Standard Switch Box	•	•
4515FS	4515FSGAS	Round mat, 4 Screw Box mounting	•	•
4516	4516GAS	Rectangular mat, mounts to Standard Switch Box (includes #348 strap for Despard switches)	•	•

For Dustproof Stainless Steel Covers, see Page S-28.

WEATHERPROOF BOXES & COVERS

Cast Weatherproof Boxes & Covers

CA8GH and WPB23

Cast Weatherproof Boxes and Covers

- A. Stainless steel springs.**
- B. Baked-on electrostatic, polyester, powder paint,** for superior scratch- and corrosion-resistant finish.
- C. Heavy die-cast aluminum.**
- D. Available in 1/2" and 3/4" hub sizes,** from 3 to 6 hole configurations.

Product assembled after painting for complete corrosion resistance.

Covers available in 1 & 2 gang in a variety of configurations.

No rough edges.

Available in gray, white and bronze.

Available in standard and deep configurations.

UL Listed, for wet and/or damp locations with appropriate cover.

Boxes available in 1, 2 & 3 gang.

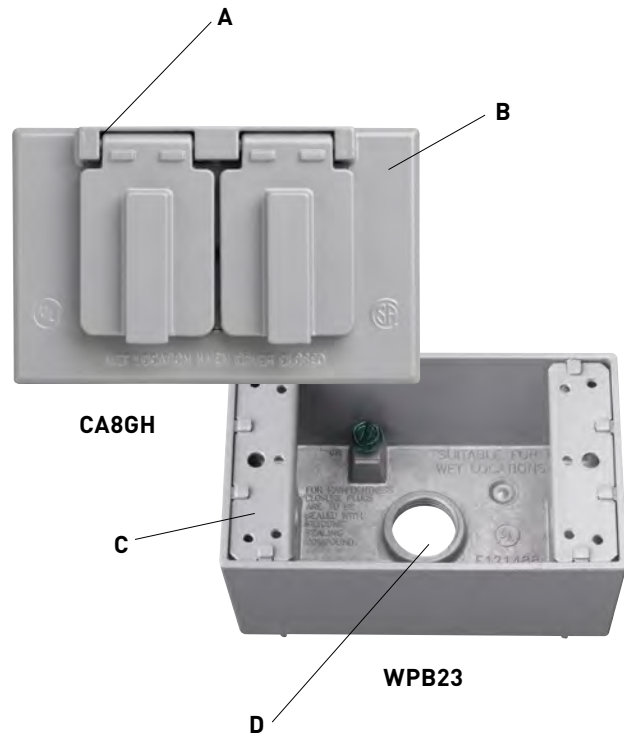

WEATHERPROOF BOXES & COVERS

Weatherproof Boxes

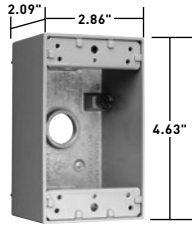

Single Gang Box

Features

- Wide range of sizes, depths, and gangs.
- Baked-on electrostatic, polyester, powder paint for superior scratch and corrosion resistance.
- 2 closure plugs and mounting lugs furnished with all boxes.
- UL Listed for wet and/or damp locations with appropriate cover.
- Designed for both interior and exterior applications.
- Will accept standard 4 screw mounting covers and single gang weatherproof covers.
- Simply strike desired knockout studs with a sharp hammer blow for clean mounting holes.
- Heavy die-cast aluminum.

CATALOG NUMBER	DESCRIPTION	COLOR	3RD PARTY COMPLIANCE	
			UL	SIR
SINGLE GANG BOXES				
WPB23 WPB23W	 3 Hole 1/2", 18.5 Cu. In. (1 Hole Each End, 1 Hole in Back)	Gray White	•	•
WPB33 WPB33W	 3 Hole 3/4", 18.5 Cu. In. (1 Hole Each End, 1 Hole in Back)	Gray White	•	•
WPB24 WPB24W	 4 Hole 1/2", 18.0 Cu. In. (2 Holes One End, 1 Hole Other End, 1 Hole in Back)	Gray White	•	•
WPB34 WPB34W	 4 Hole 3/4", 18.0 Cu. In. (2 Holes One End, 1 Hole Other End, 1 Hole in Back)	Gray White	•	•
WPB25 WPB25W	 5 Hole 1/2", 17.0 Cu. In. (2 Holes Each End, 1 Hole in Back)	Gray White	•	•
WPB35	 5 Hole 3/4", 17.0 Cu. In. (2 Holes Each End, 1 Hole in Back)	Gray	•	•
WPB26 WPB26W	 5 Hole 1/2", 17.0 Cu. In. (1 Hole Each End, 1 Hole Each Side, 1 Hole in Back)	Gray White	•	•
WPB36	 5 Hole 3/4", 16.8 Cu. In. (1 Hole Each End, 1 Hole Each Side, 1 Hole in Back)	Gray	•	•

CATALOG NUMBER	DESCRIPTION
WEATHERPROOF LOCKING INLET KIT FOR GENERATOR APPLICATIONS	
L1430FIKIT	Kit includes 30A Locking Gray Flanged Inlet L1430FI, Weatherproof Cover WPG2, and Weatherproof Box WPB23 with 1/2" knockout holes.

WEATHERPROOF BOXES & COVERS

Weatherproof Boxes

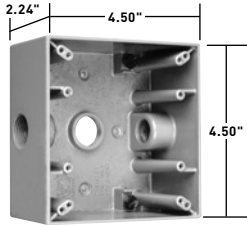

Two Gang Box

Features

- Wide range of sizes, depths, and gangs.
- Baked-on electrostatic, polyester, powder paint for superior scratch and corrosion resistance.
- 2 closure plugs and mounting lugs furnished with all boxes.
- UL Listed for wet and/or damp locations with appropriate cover.
- Designed for both interior and exterior applications.
- Will accept standard two gang weatherproof covers.
- Simply strike desired knockout studs with a sharp hammer blow for clean mounting holes.
- Heavy die-cast aluminum.

CATALOG NUMBER	DESCRIPTION	COLOR	3RD PARTY COMPLIANCE	
			UL	SR
TWO GANG BOXES				
WPB232 WPB232W	2 Gang – 3 Hole 1/2", 30.5 Cu. In. (1 Hole Each End, 1 Hole in Back)	Gray White	•	•
WPB332	2 Gang – 3 Hole 3/4", 30.5 Cu. In. (1 Hole Each End, 1 Hole in Back)	Gray	•	•
WPB242	2 Gang – 4 Hole 1/2", 30.5 Cu. In. (2 Holes One End, 1 Hole Other End, 1 Hole in Back)	Gray	•	•
WPB342 WPB342W	2 Gang – 4 Hole 3/4", 30.5 Cu. In. (2 Holes One End, 1 Hole Other End,	Gray White	•	•
WPB252	2 Gang – 5 Hole 1/2", 30.5 Cu. In. (2 Holes Each End, 1 Hole in Back)	Gray	•	•
WPB352	2 Gang – 5 Hole 3/4", 30.5 Cu. In. (2 Holes Each End, 1 Hole in Back)	Gray	•	•
WPB262	2 Gang – 5 Hole 1/2", 30.5 Cu. In. (1 Hole Each End, 1 Hole Each Side, 1 Hole in Back)	Gray	•	•
WPB362	2 Gang – 5 Hole 3/4", 30.5 Cu. In. (1 Hole Each End, 1 Hole Each Side, 1 Hole in Back)	Gray	•	•
WPB272	2 Gang – 6 Hole 1/2", 30.5 Cu. In. (2 Holes One End, 1 Hole Other End, 1 Hole Each Side, 1 Hole in Back)	Gray	•	•
WPB276	2 Gang – 6 Hole 1/2", 30.5 Cu. In. (3 Holes One Side, 2 Holes Other Side, 1 Hole in Back)	Gray	•	•
WPB282	2 Gang – 7 Hole 1/2", 30.5 Cu. In. (2 Holes Each End, 1 Hole Each Side, 1 Hole in Back)	Gray	•	•
WPB382	2 Gang – 7 Hole 3/4", 30.5 Cu. In. (2 Holes Each End, 1 Hole Each Side, 1 Hole in Back)	Gray	•	•
WPB287	2 Gang – 7 Hole 1/2", 30.5 Cu. In. (3 Holes Each Side, 1 Hole in Back)	Gray	•	•
WPB387	2 Gang – 7 Hole 3/4", 30.5 Cu. In. (3 Holes in Each Side, 1 Hole in Back)	Gray	•	•

WEATHERPROOF BOXES & COVERS

Weatherproof Boxes

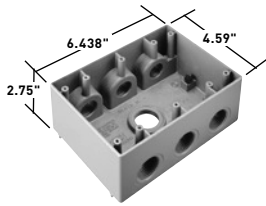

Three Gang Box

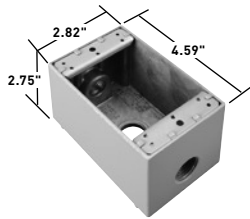

1 Gang Deep Box

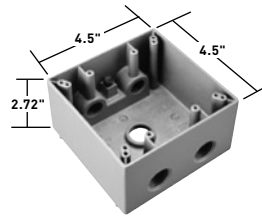

2 Gang Deep Box

Features

- Wide range of sizes, depths, and gangs.
- Baked-on electrostatic, polyester, powder paint for superior scratch and corrosion resistance.
- 2 closure plugs and mounting lugs furnished with all boxes.
- UL Listed for wet and/or damp locations with appropriate cover.
- Designed for both interior and exterior applications.
- Simply strike desired knockout studs with a sharp hammer blow for clean mounting holes.
- Heavy die-cast aluminum.

CATALOG NUMBER	DESCRIPTION	COLOR	3RD PARTY COMPLIANCE	
			UL	CSA
THREE GANG BOX				
WPB373	 3 Gang – 7 Hole 3/4", 59.8 Cu. In. (3 Holes Each Side, 1 Hole in Back)	Gray	•	•

Features

- Baked-on electrostatic, polyester, powder paint for superior scratch and corrosion resistance.
- 4 closure plugs and mounting lugs furnished with all boxes.
- UL Listed for wet and/or damp locations with appropriate cover.
- Designed for both interior and exterior applications.
- Will accept standard three-gang weatherproof covers.
- Simply strike desired knockout studs with a sharp hammer blow for clean mounting holes.
- Heavy die-cast aluminum.

CATALOG NUMBER	DESCRIPTION	COLOR	3RD PARTY COMPLIANCE	
			UL	CSA
1 GANG DEEP BOXES				
WPBD23 WPBD23BR WPBD23W	1 Gang Deep – 3 Hole 1/2", 23 Cu. In. with Threaded Holes (1 Hole Each Side, 1 Hole in Back)	Gray Bronze White	•	•
WPBD33	1 Gang Deep – 3 Hole 3/4", 23 Cu. In. with Threaded Holes (1 Hole Each Side, 1 Hole in Back)	Gray	•	•
WPBD43	1 Gang Deep – 3 Hole 1", 23 Cu. In. with Threaded Holes (1 Hole Each Side, 1 Hole in Back)	Gray	•	•
2 GANG DEEP BOXES				
WPBD252	2 Gang Deep – 5 Hole 1/2", 37 Cu. In. with Threaded Holes (2 Holes Each End, 1 Hole in Back)	Gray	•	•
WPBD352	2 Gang Deep – 5 Hole 3/4", 37 Cu. In. with Threaded Holes (2 Holes Each End, 1 Hole in Back)	Gray	•	•
WPBD452	2 Gang Deep – 5 Hole 1", 37 Cu. In. with Threaded Holes (2 Holes Each End, 1 Hole in Back)	Gray	•	•

WEATHERPROOF BOXES & COVERS

Weatherproof Round Boxes & Weatherproof Kits



WPRB25



WPWIUKITC



WPGFIKIT



WPOUTKIT



WPFLDKIT

Features – 4" Round Die-Cast Aluminum Boxes

- Baked-on electrostatic, polyester, powder paint for superior scratch and corrosion resistance.
- 4 closure plugs and mounting lugs furnished with all boxes.
- UL Listed for wet and/or damp locations with appropriate cover.
- Designed for both interior and exterior applications.
- Heavy die-cast aluminum.

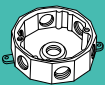
CATALOG NUMBER	DESCRIPTION	COLOR	3RD PARTY COMPLIANCE	
			UL	SF
4" ROUND DIE-CAST ALUMINUM BOXES				
WPRB25 	Round Cast Box – 5 Hole 1/2", 16.1 Cu. In., 4 Plugs Furnished	Gray	•	•
WPRB35 WPRB35W 	Round Cast Box – 5 Hole 3/4", 16.1 Cu. In., 4 Plugs Furnished	Gray White	•	•

Features

- Easy-to-install, self-contained kits include everything needed for installation – gaskets, plugs, and hardware.
- Clam-shell packaging designed for hanging displays.

CATALOG NUMBER	COLOR	DESCRIPTION	COMPONENTS	3RD PARTY COMPLIANCE
				cULus
WEATHERPROOF KITS				
WPWIUKITW	White	Weatherproof While-in-Use Safety Outlet (GFCI) Kit includes GFCI, box, and While-In-Use cover	1595W, WPB23W, WIUC10WL	•
WPGFIKIT	Gray	Weatherproof Safety Outlet (GFCI) Kit includes GFCI, box and cover	1595GRY, WPB23, CA26GH	•
WPOUTKIT	Gray	Weatherproof Outlet Kit includes outlet, box and cover	3232I, WPB23, CA8GH	•
WPOUTKITW	White		3232W, WPB23W, CA8WH	•
WPFLDKITW	White	Weatherproof Dual Floodlight Kit includes box, cover, and lampholders	WPRB25W, (2) PAR1W, WPRB12W	•

WEATHERPROOF BOXES & COVERS

WEATHERPROOF BOXES & COVERS

Cluster & Blank Covers

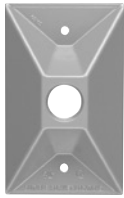

WPB11



WPRB1

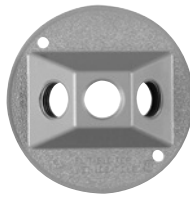

WPRB13



WPB1



Features

- Wide range of rectangular and round covers.
- Baked-on electrostatic, polyester, powder paint for superior scratch and corrosion resistance.
- Kits available combining fixtures, lamp covers, and accessories.

CATALOG NUMBER	DESCRIPTION	COLOR	3RD PARTY COMPLIANCE	
			UL US	CSA
OUTDOOR LAMP CLUSTER COVERS FOR SINGLE GANG BOXES				
WPB11 WPB11W	 Rectangular Single Gang Cover 1 Hole 1/2"	Gray White	•	•
WPB12 WPB12W	 Rectangular Single Gang Cover 2 Hole 1/2", 1 Plug Furnished	Gray White	•	•
WPB13 WPB13W	 Rectangular Single Gang Cover 3 Hole 1/2", 2 Plugs Furnished	Gray White	•	•
4" ROUND OUTDOOR CLUSTER COVERS				
WPRB1 WPRB1W	 Round Blank Cover with Gasket and Screws	Gray White	•	•
WPRB11 WPRB11W	 Round Cover – 1 Hole 1/2" with Gasket and Screws	Gray White	•	•
WPRB12 WPRB12W	 Round Cover – 2 Hole 1/2" with Gasket and Screws 1 Plug Furnished	Gray White	•	•
WPRB13 WPRB13W	 Round Cover – 3 Hole 1/2" with Gasket and Screws 2 Plugs Furnished	Gray White	•	•

Features

- Designed for both interior and exterior applications.
- Universal aluminum mounting plates.
- Gray, bronze and white models have baked-on electrostatic, polyester, powder paint for superior scratch and corrosion resistance.

CATALOG NUMBER	DESCRIPTION	COLOR	3RD PARTY COMPLIANCE	
			UL	CSA
BLANK COVERS				
WPB1 WPB1G WPB1W	 1 Gang Blank Aluminum Cover with Gasket and Screws	Brushed Aluminum Gray White	•	•
WPB2 WPB2G WPB2W	 2 Gang Blank Aluminum Cover with Gasket and Screws	Brushed Aluminum Gray White	•	•
WPB3	 3 Gang Blank Aluminum Cover with Gasket and Screws	Brushed Aluminum	•	•

WEATHERPROOF BOXES & COVERS

Lighting Accessories & Swimming Pool Junction Box



PAR1



WPLKIT2



GARD3BK

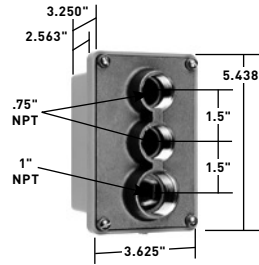

WPBJ22

Features

- Now rated for CFL/LED.
- Medium base heat resistant.
- Fits 1/2" threaded outlet.
- Seal gasket included.
- Adjustable through 180°.
- Complete range of lamp covers in gray and white.
- Corrosion-resistant finish.

CATALOG NUMBER	DESCRIPTION	COLOR	3RD PARTY COMPLIANCE	
			C ^{RU} US	CSA
DIE-CAST OUTDOOR LAMPHOLDER				
PAR1	Outdoor Lampholder	Gray	•	•
PAR1W	Outdoor Lampholder	White	•	•

CATALOG NUMBER	DESCRIPTION	COLOR	3RD PARTY COMPLIANCE	
			C ^{RU} US	CSA
OUTDOOR LAMPHOLDER KITS				
WPLKIT1	Kit includes (1) WPRB13 and (2) PAR1 Lampholders	Gray	•	•
WPLKIT2	Kit includes (1) WPRB13W and (2) PAR1W Lampholders	White	•	•
WPLKIT3	Kit includes (1) WPB13 and (2) PAR1 Lampholders	Gray	•	•
WPLKIT4	Kit includes (1) WPB13W and (2) PAR1W Lampholders	White	•	•

CATALOG NUMBER	DESCRIPTION	COLOR	3RD PARTY COMPLIANCE	
			C ^{RU} US	CSA
OUTDOOR GARDEN LAMPS & ACCESSORIES				
GARD3GR	3 Tier Garden Lamp	Green	•	•
GARD3BK	3 Tier Garden Lamp	Black	•	•

CATALOG NUMBER	DESCRIPTION	COLOR	3RD PARTY COMPLIANCE	
			UL	CSA
SWIMMING POOL JUNCTION BOX				
WPBJ22	22 cu. in. Thermoplastic Base, Brass Cover. Meets NEC® Article 680. Two 3/4" Hubs, one 1" Hub. Four Ground Posts, Gasket, and Mounting Screws Included.	Gray	•	•

WEATHERPROOF BOXES & COVERS

Gaskets & Accessories

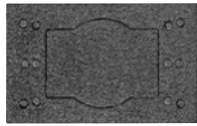

GASKET38

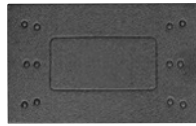

GASKET3726

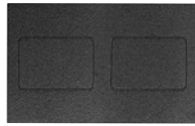

GASKET3780

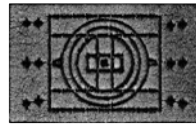

WPGAS100

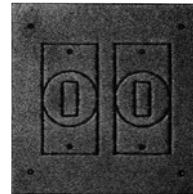

WPGAS101

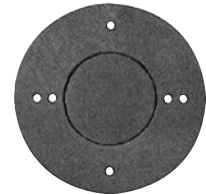

WPGASR101

CATALOG NUMBER	DESCRIPTION	COLOR	3RD PARTY COMPLIANCE	
			UL	
GASKETS				
GASKET2	1/8" Thick, 1 Gang, Multiuse Gasket, Closed Cell Polyethylene	Black	•	
GASKET38 GASKET38W	3/8" Thick, Weatherproof, 1 Gang, Multiuse Gasket, Closed Cell Polyethylene	Black White		
GASKET3726	3/32" Thick, Weatherproof, 1 Gang, Decorator Multiuse Gasket, Closed Cell Polyethylene	Gray	•	
GASKET3780	3/32" Thick, Weatherproof, 1 Gang, Duplex Multiuse Gasket, Closed Cell Polyethylene	Gray	•	
WPGAS100	1/8" Thick, Weatherproof, 1 Gang, Multiuse Gasket, Closed Cell Polyethylene	Black		
WPGAS101	1/8" Thick, Weatherproof, 2 Gang, Multiuse Gasket, Closed Cell Polyethylene	Black		
WPGASR101	1/8" Thick, Weatherproof, Round, Multiuse Gasket, Closed Cell Polyethylene	Black		



WPEX1



WPEX2



WPEX3

CATALOG NUMBER	DESCRIPTION	COLOR	3RD PARTY COMPLIANCE	
			UL	CSA
ACCESSORIES				
WPEX1	1 Gang Extension Ring, 9.5 Cu. In., 2.75" x 4.5" x 1"	Gray		•
WPEX2	2 Gang Extension Ring, 16.3 Cu. In., 4.5" x 4.5" x 1"	Gray		•
WPEX3	Round Device Box Extension, 4-1/2" Hubs	Gray		•
WPEX4	1 Gang Extension Ring with 4-1/2" Hubs, 2-1/2" Plugs Supplied, 9.5 Cu. In.	Gray		•
WPEX5	1 Gang Flanged Extension Ring with 4-1/2" Hubs, 2-1/2" Plugs Supplied, 9.5 Cu. In.	Gray		•
WPEX6	1 Gang Extension Ring, with 4-3/4" Hubs, 2-3/4" Plugs Supplied, 9.5 Cu. In.	Gray		•
WPBP50 WPBP50CC WPBP50WCC	Closure Plug - 1/2"	Metallic, Qty. 100 Gray, Qty. 3 White, Qty. 3	• • •	• • •
WPBP75 WPBP75CC WPBP75WCC	Closure Plug - 3/4"	Metallic, Qty. 100 Gray, Qty. 3 White, Qty. 3	• • •	• • •
WPBP100CC	Closure Plug - 1"	Metallic, Qty. 100	•	•
WPBL100	Aluminum Lugs (2), and Self-Tapping Screws	Gray		

WEATHERPROOF BOXES & COVERS

WEATHERPROOF BOXES & COVERS

NEC® Compliance

Choose the cover according to the location in which it is to be used.

Outdoor Wet Locations NEC 406.9(B)(1)

Wet locations are defined as those subjected to saturation with water or other liquids, such as vehicle washing areas, unprotected locations exposed to weather, or in installations under ground or in concrete slabs or masonry in direct contact with the earth.

NEC Article 406.8(B)(1) requires that all 15 and 20 amp, 125 & 250 volt receptacles installed in wet locations must have an enclosure that is weatherproof, whether or not a plug is inserted. These receptacles must use a while-in-use cover, such as those shown below:

WIUC10GL	WIUC10SW	WIUC20GL	WIUC10SQC
WIUC10CL	WIUC10SB	WIUC20CL	WIUC10W
WIUC10WL	WIUC10DGL	WIUC20WL	WIUC10WQC
WIUC10SG	WIUC10DCL	WIUCAST1	WIUC10FRED
WIUC10SC	WIUC10DWL	WIUC10S	WIUC20FRED

Other Wet Locations NEC 406.8(B)(1)

- (a) A receptacle installed in a wet location, where the product intended to be plugged into it is not attended while in use, shall have an enclosure that is weatherproof with the attachment plug cap inserted or removed.
- (b) A receptacle installed in a wet location where the product intended to be plugged into it will be attended while in use (e.g., portable tools) shall have an enclosure that is weatherproof when the attachment plug is removed.

CA1G	CA8GJ	WPWIUKITW	3726SCWH	4510
CA1GL	CA8GVFS	3393	3770SC	4511
CA1GS	CA8WH	3700	3778	4512
CA126GRY	CA8WV	3700FS	3780SC	4515
CA17G	CA8WVFS	3703	3780SCBG	4515FS
CA18G	CA82G	3703FS	3780SCCW	4516
CA2G	CA82W	3703T	3780SCCWT	4517
CA2GS	WP13	3703TCW	3780SCFBX	4600
CA2W	WP13FS	3710	3780SCFBXCW	7420
CA26GH	WP23	3710FS	3780SCFBXWH	7700
CA26GV	WPBJ22	3710WH	3780SCLV	
CA26WH	WPFLDKIT	3720	3780SCLVBG	
CA26WV	WPFLDKITW	3720FS	3780SCLVCW	
CA262G	WPGFIKIT	3720WH	3780SCLVWH	
CA268G	WPGFIKITW	3722FS	3780SCMH	
CA7GV	WPG1	3723	3780SCMHBG	
CA72G	WPG2	3723FS	3780SCMHCW	
CA721G	WPOUTKIT	3723WH	3780SCMHHW	
CA723G	WPOUTKITW	3724FS	3780SCWH	
CA726G	WPWIUKITC	3726SC	3795	
CA78G	WPWIUKITSC	3726SCBG	3796	
CA8GH	WPWIUKITSW	3726SCCW	3797	

Damp Locations NEC 406.9(A)

Damp locations are defined as those protected from weather and not subject to saturation with water or other liquids, but subject to moderate degrees of moisture. Examples of such locations include partially protected locations under canopies, marquees, and roofed open porches not subjected to a beating rain or water runoff, as well as interior locations such as some basements, barns, and cold-storage warehouses.

NEC Article 406.9(A) requires that receptacles installed in damp locations must have an enclosure that is weatherproof when the receptacle is covered (attachment plug is not inserted and receptacle cover is closed).

An installation suitable for wet locations shall also be considered suitable for damp locations. Therefore, all catalog numbers shown above are also suitable for use in damp locations. The covers below are suitable for damp locations only, because the lid can be propped in the full open position.

3760 3763 3780

Weather-Resistant Receptacles in Damp and Wet Locations NEC 406.9(A) and 406.9(B)(1)

An additional requirement has been added which states that a listed weather-resistant receptacle must be used where 15- and 20-amp, 125- and 250-volt straight blade receptacle configurations are installed in damp or wet locations. The goal of the change is to ensure that receptacles of sufficiently robust design are employed under these conditions. Listed weather-resistant receptacles have improved resistance to sunlight exposure, corrosion and impact.

Switches in Damp or Wet Locations NEC 404.4

Surface-mounted switches and circuit breakers in damp or wet locations are required to be enclosed in a weatherproof enclosure and flush-mounted switches and circuit breakers in damp or wet locations to be provided with weather-proof covers. This change recognizes that exposure to adverse weather conditions requires comparable protection for switches and receptacles used in damp or wet locations.

WALL PLATES & SPECIALTIES



Featured Products



**RADIANT® FINISH
SCREWLESS
WALL PLATES** S-6



**COMBINATION
OPENINGS** S-15

Specifications & Dimensions	S-3	Decorator-Style Openings & Blank Plates	S-23
Screwless Wall Plates	S-6	Combination Openings	S-24
Toggle Switch Openings	S-8	Sectional Wall Plates	S-25
Duplex Receptacle Openings & Decorator-Style Openings	S-9	Tandem & Handy Box Plates	S-26
Decorator-Style Openings	S-10	Narrow Metal	S-27
Blank Plates	S-11	Dustproof Stainless Steel Covers	S-28
Single Receptacle Openings & Power Outlet Openings	S-13	Communication Devices & Plates	S-29
Combination Openings	S-15	Mounting Straps, Yokes & Jewels	S-35
Despard® Openings	S-19	Incandescent Lampholders, Neon Pilot Lights	S-36
Two Gang with Center Opening & Locking Switch Plates	S-20	Screws & Screwdrivers	S-37
Louver & Biplex/Triplex Openings	S-21	Engraved & Pad Printed	S-38
Toggle Switch, Duplex & Single Receptacle Openings	S-22	Custom Metal Wall Plates	S-40
		Custom Panel Plates	S-43
		Style Selector Guide	S-45

WALL PLATES & SPECIALTIES

RWP26LA

radiant® Screwless Polycarbonate Wall Plates

- A. Redesigned screwless wall plates** feature a lower, more modern profile in keeping with today's design trends.
- B. Molded of rugged .065" thick polycarbonate.**
- C. One-piece subplate** mounts over the device for easy retrofit and lower profile.
- D. Subplate screws align devices** to ensure proper positioning of wall plates.
- E. Opening accommodates all NEMA decorator-opening devices.**
- F. An extra 3/8" width and height than standard size wall plates** for more tolerance in covering ragged sheet rock openings.

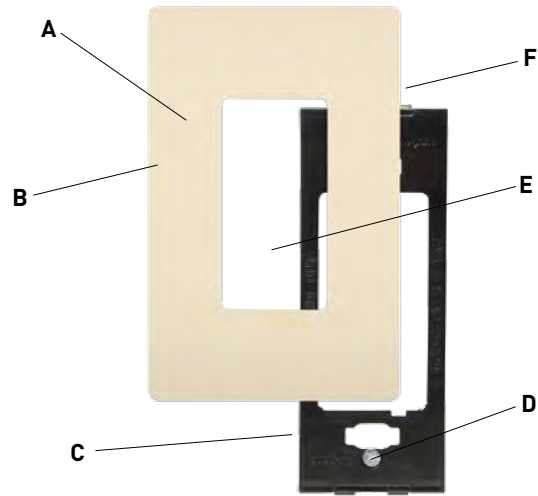

RWP26LA

The radiant® collection is a step up from the standard with simple, classic options in wiring devices, home automation controls, and screwless wall plates that complement today's homes and hospitality settings.

WALL PLATES

Specifications



**radiant®
Screwless
Polycarbonate
RWP Series**



**Thermoset
SP Series**



**Nylon
TP Series**



**302/304
Stainless
Steel**



**Polished
Brass**



Aluminum

Application

Legrand's broad line of Pass & Seymour® Standard Size Plastic and Metal Wall Plates features the most complete range of types, sizes, colors, and finishes available. Choose from more than 1,900 standard plates in non-combustible thermoset plastic material, self-extinguishing nylon material, screwless polycarbonate material, or attractively finished metal, for residential, commercial, institutional, and industrial applications. All plastic wall plates color match to Pass & Seymour devices.

Screwless Polycarbonate Wall Plates

- Part of the radiant® collection.
- Molded of .065" thick polycarbonate, matte finish.
- One-piece subplate mounts over the device for easy retrofit and lower profile.
- Extra 3/8" width and height than Standard size plates.
- Available in Ivory, White, Brown, Gray, Black, and Light Almond; and two metallic finishes – nickel, dark bronze.

Thermoset Plastic Wall Plates

- Molded of non-combustible mar-proof material.
- Available in "SP" series in Standard, Junior-Jumbo, and Jumbo sizes.
- Seven standard colors available – Ivory, White, Brown, Gray, Black, Red, and Light Almond.
- Individually wrapped with color-matching screws.
- Resistant to discoloration, grease, oil, solvent and moisture.
- Nominal thickness, .070"

TradeMaster® Thermoplastic Wall Plates

- Molded of rugged, practically indestructible self-extinguishing nylon. ("TP" series only)
- Available in "TP" series, extra 3/16" width and height than Standard size plates; and "TPJ" series, extra 3/16" width and height than Junior-Jumbo size plates.
- Available in Ivory, White, Brown, Gray, Black, Blue, Orange, Red, and Light Almond.
- Preferred for hospital, industrial, institutional, and other high-abuse applications.
- Nominal thickness, .070"

Metal Wall Plates

- Constructed of corrosion-resistant stainless steel, brass, aluminum, chrome, brushed bronze or galvanized steel.
- Standard, Jumbo and Tandem size plates available, as well as special Panel size plates up to 5-gangs high and 10-gangs wide.
- Packaged in protective film, with finish-matching screws.
- Variety of special plated finishes. Paintable to match plastic plates.
- Can be silk-screened or engraved, and custom punched with over 300 opening styles.

Materials

- Type 302/304 Stainless Steel, non-magnetic, .032" nominal thickness, brushed finish. This alloy contains 18% chromium and 8% nickel for superior resistance to corrosion. Recommended for use in food processing plants, dairies, chemical plants, and other industrial, institutional, and commercial applications where corrosive atmospheres exist.
- Type 430 Stainless Steel, magnetic, .032" nominal thickness, brushed finish. Less corrosion-resistant than Type 302/304, but ideal for general service in high abuse applications in industrial plants, commercial, and institutional buildings.
- Chrome and Polished Brass, .040" thick. 70% copper, 30% zinc alloy gives warm, appealing finish to modern decor as well as retrofit applications. Lacquered to prevent corrosion.
- Aluminum, .040" thick. Lustrous satin finish. Lacquered to prevent corrosion.
- Galvanized Steel. Used only for Handy Box Plates.
- Brushed Bronze, .040" thick. 90% copper, 10% zinc. Lacquered to prevent corrosion.

WALL PLATES

Dimensions

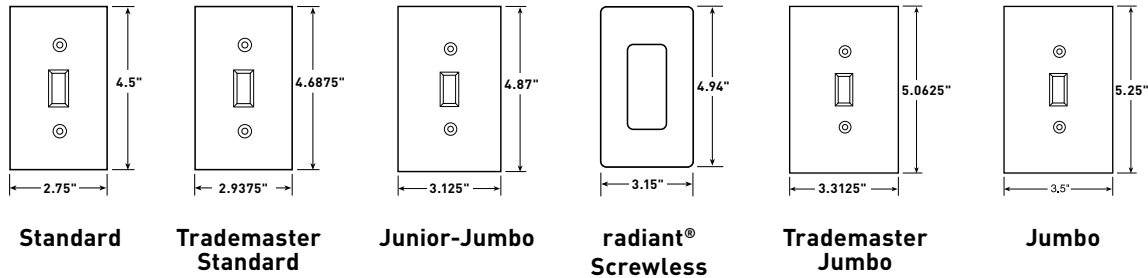

Standard Size Wall Plates

- Standard size wall plates for all applications.
- Best fit for surface mount boxes.
- Available in plastic and metal only.

Dimensions

1 gang	2.75" x 4.5"
2 gang	4.56" x 4.5"
3 gang	6.375" x 4.5"
4 gang	8.125" x 4.5"
5 gang	10" x 4.5"
6 gang	11.812" x 4.5"
7 gang	13.62" x 4.5"
8 gang	15.44" x 4.5"

TradeMaster® Wall Plates

- Extra 3/16" width and height than Standard size wall plates.
- Provide better sheet rock coverage with standard size appearance.
- Available in unbreakable nylon 6 construction only.
- Screws pre-installed in the duplex, toggle and decorator-style single gang plates.

Dimensions

1 gang	2.9375" x 4.6875"
2 gang	4.75" x 4.6875"
3 gang	6.563" x 4.6875"
4 gang	8.375" x 4.6875"
5 gang	10.188" x 4.6875"
6 gang	12" x 4.6875"

radiant® Screwless Polycarbonate Wall Plates

- Available in decorator-style openings.
- Extra 3/8" width and height than Standard size wall plates.
- Provide better sheet rock coverage with standard size appearance.
- Molded of .065" thick polycarbonate.
- 1-piece plastic subplate.
- Available in 2 metallic finishes and 6 standard colors.

Wall Plate Dimensions

1 gang	3.15" x 4.94"
2 gang	4.96" x 4.94"
3 gang	6.77" x 4.94"
4 gang	8.59" x 4.94"
5 gang	10.40" x 4.94"
6 gang	12.21" x 4.94"

Subplate Dimensions

1 gang	1.81" x 4.78" x .15"
2 gang	3.62" x 4.78" x .15"
3 gang	5.44" x 4.78" x .15"
4 gang	7.25" x 4.78" x .15"
5 gang	9.06" x 4.78" x .15"
6 gang	10.87" x 4.78" x .15"

Junior-Jumbo Wall Plates

- Extra 3/8" width and height than Standard size wall plates.
- Additional coverage for sheet rock gaps.
- Available in plastic and metal only.

Dimensions

1 gang	3.125" x 4.87"
2 gang	4.93" x 4.87"
3 gang	6.75" x 4.87"
4 gang	8.56" x 4.87"

TradeMaster® Jumbo Wall Plates

- Extra 3/16" width and height than Junior-Jumbo size wall plates.
- Provide additional coverage for sheet rock gaps, matching the appearance of the TradeMaster Plates.
- Available in unbreakable nylon 6 construction only.
- Screws pre-installed in the duplex, toggle and decorator-style single gang plates.

Dimensions

1 gang	3.3125" x 5.0625"
2 gang	5.125" x 5.0625"
3 gang	6.9375" x 5.0625"
4 gang	8.75" x 5.0625"

Jumbo Wall Plates

- Extra 3/4" width and height than Standard size wall plates.
- Largest size wall plates to cover larger wall damage.
- Available in plastic and metal only.

Dimensions

1 gang	3.5" x 5.25"
2 gang	5.31" x 5.25"
3 gang	7.12" x 5.25"
4 gang	8.93" x 5.25"

WALL PLATES

Dimensions

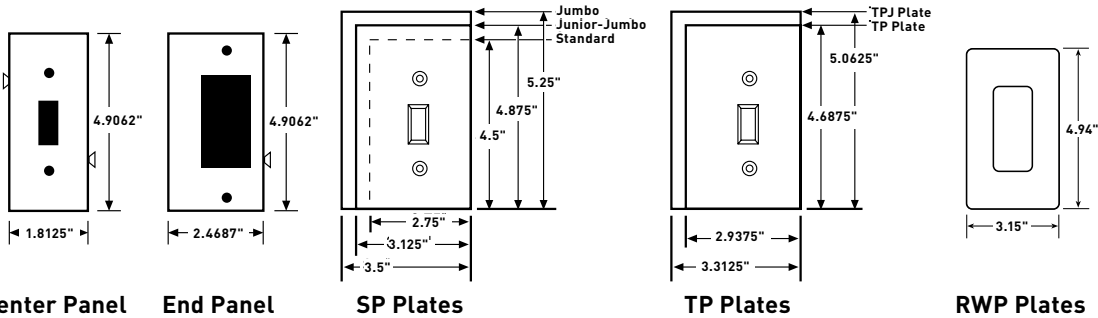

Center Panel End Panel SP Plates TP Plates RWP Plates

Sectional Wall Plates

End and center panels with each of five most-used configurations make it possible to improvise custom wall plates on the job. Panels lock securely together on installation. Blank sections furnished with mounting strap.

Wall Plate Mountings

Illustrated are the five standard methods of plate mounting. There are many other non-standard methods which depend upon the special device used. Exact mounting hole specifications for every device appear in the Selector Guide.

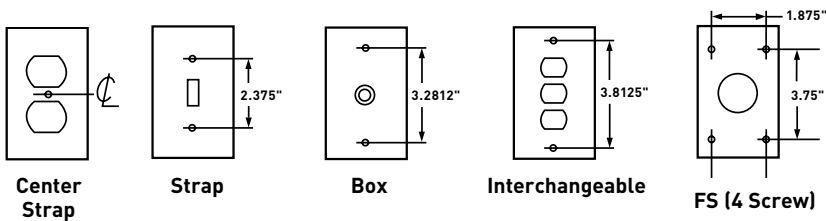

Center Strap Strap Box Interchangeable FS (4 Screw)

Wall Plate Sizes

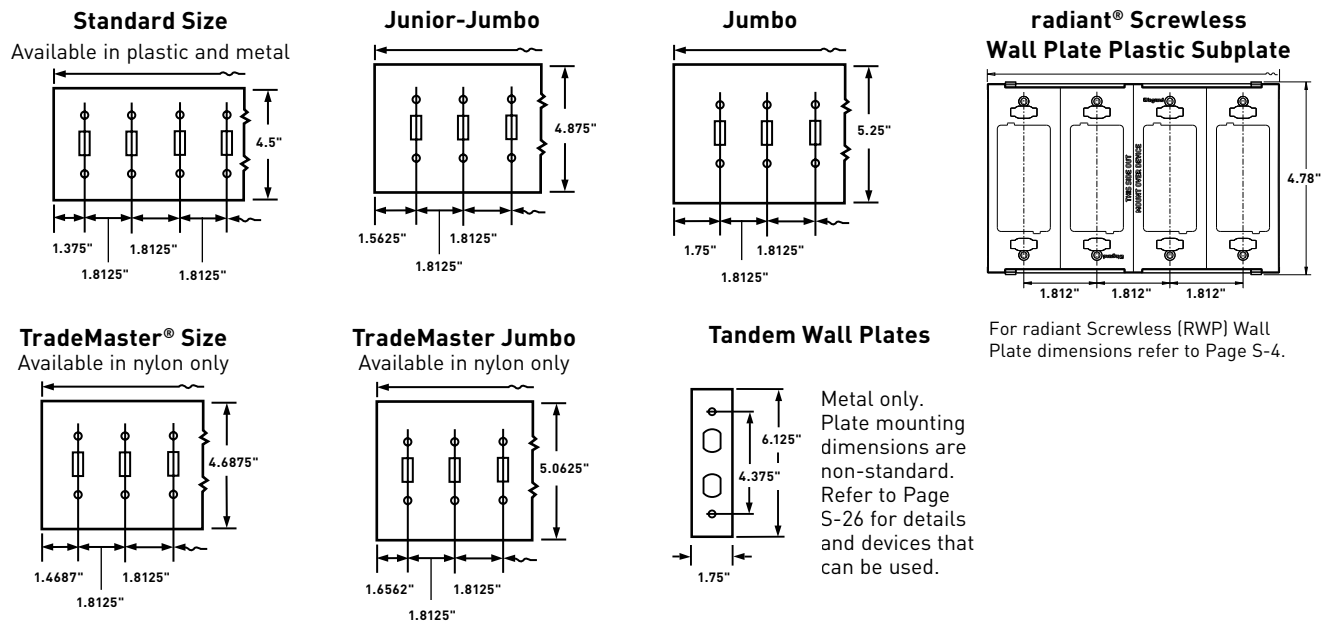

For radiant Screwless (RWP) Wall Plate dimensions refer to Page S-4.

WALL PLATES







radiant® Metallic Finish Screwless Wall Plates Polycarbonate



**One Gang
Nickel**



**Two Gang
Dark Bronze**

DESCRIPTION	COLOR	26 OPENINGS
SCREWLESS DECORATOR-STYLE OPENINGS PLASTIC SUBPLATE INCLUDED		
One Gang 	Nickel Dark Bronze	RWP26NI RWP26DBCC6
Two Gang 	Nickel Dark Bronze	RWP262NI RWP262DBCC6
Three Gang 	Nickel Dark Bronze	RWP263NI RWP263DBCC6
Four Gang 	Nickel Dark Bronze	RWP264NI RWP264DB
Five Gang 	Nickel Dark Bronze	RWP265NI RWP265DB
Six Gang 	Nickel Dark Bronze	RWP266NI RWP266DB

For Screwless Wall Plate and Plastic Subplate dimensions, see Pages S-4 and S-5.

WALL PLATES

radiant® Screwless Wall Plates Polycarbonate

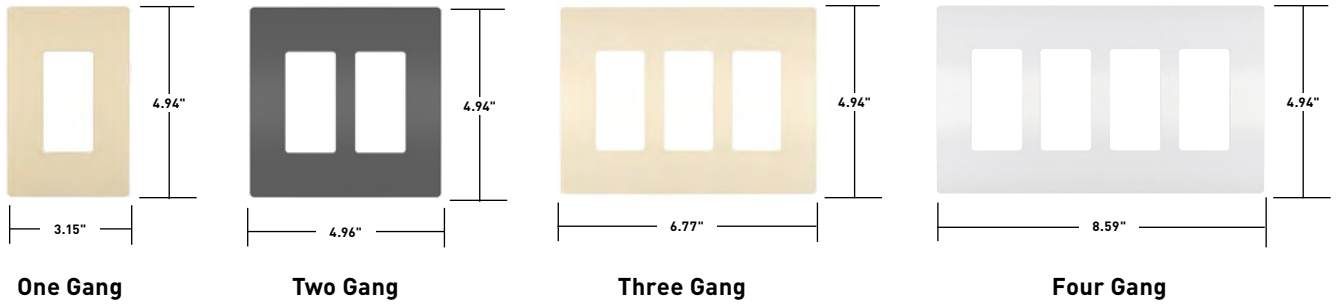

DESCRIPTION	COLOR	26 OPENINGS
SCREWLESS WALL PLATES PLASTIC SUBPLATE INCLUDED		
One Gang	Ivory White Brown Gray Black Light Almond	RWP261 RWP26W RWP26 RWP26GRY RWP26BK RWP26LA
Two Gang	Ivory White Brown Gray Black Light Almond	RWP2621 RWP262W RWP262 RWP262GRY RWP262BK RWP262LA
Three Gang	Ivory White Brown Gray Black Light Almond	RWP2631 RWP263W RWP263 RWP263GRY RWP263BK RWP263LA
Four Gang	Ivory White Brown Gray Black Light Almond	RWP2641 RWP264W RWP264 RWP264GRY RWP264BK RWP264LA
Five Gang	Ivory White Brown Gray Black Light Almond	RWP2651 RWP265W RWP265 RWP265GRY RWP265BK RWP265LA
Six Gang	Ivory White Brown Gray Black Light Almond	RWP2661 RWP266W RWP266 RWP266GRY RWP266BK RWP266LA

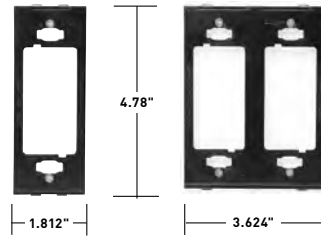



One Gang Plastic Subplate **Two Gang Plastic Subplate**

DESCRIPTION	HEIGHT	WIDTH
SCREWLESS DECORATOR-STYLE OPENINGS PLASTIC SUBPLATE INCLUDED		
One Gang	4.94"	3.15"
Two Gang	4.94"	4.96"
Three Gang	4.94"	6.77"
Four Gang	4.94"	8.59"
Five Gang	4.94"	10.40"
Six Gang	4.94"	12.21"

DESCRIPTION	HEIGHT	WIDTH
SCREWLESS PLASTIC SUBPLATE DIMENSIONS		
One Gang	4.78"	1.81"
Two Gang	4.78"	3.62"
Three Gang	4.78"	5.44"
Four Gang	4.78"	7.25"
Five Gang	4.78"	9.06"
Six Gang	4.78"	10.87"





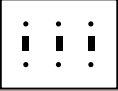
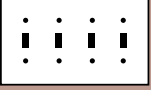
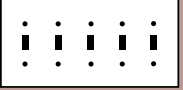
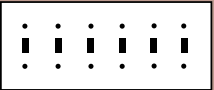
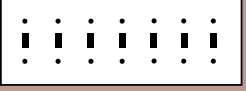
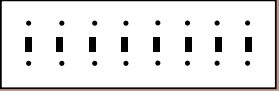

WALL PLATES

Toggle Switch Openings Standard Size Plastic & Metal

DESCRIPTION	COLOR	NYLON	THERMOSET	METAL	
		TRADEMASTER® PLATES	SMOOTH	MATERIAL	SMOOTH
TOGGLE SWITCH OPENINGS					
One Gang 	Ivory	TP1I	SP1I	Aluminum	SA1
	White	TP1W	SP1W		
	Brown	TP1	SP1	Polished Brass	SB1PB
	Gray	TP1GRY	SP1GRY	430S/S	SL1
	Black	TP1BK		302/304 S/S	SS1
	Red	TP1RED		Brushed Bronze	SB1BZ
	Light Almond	TP1LA	SP1LA	Chrome	SB1CH
Two Gang 	Ivory	TP2I	SP2I	Aluminum	SA2
	White	TP2W	SP2W		
	Brown	TP2	SP2	Polished Brass	SB2PB
	Gray	TP2GRY	SP2GRY	430S/S	SL2
	Black	TP2BK		302/304 S/S	SS2
	Red	TP2RED		Brushed Bronze	SB2BZ
	Light Almond	TP2LA	SP2LA	Chrome	SB2CH
Three Gang 	Ivory	TP3I	SP3I	Aluminum	SA3
	White	TP3W	SP3W		
	Brown	TP3	SP3	Polished Brass	SB3PB
	Gray	TP3GRY	SP3GRY	430S/S	SL3
	Black	TP3BK		302/304 S/S	SS3
	Red	TP3RED		Brushed Bronze	SB3BZ
	Light Almond	TP3LA	SP3LA	Chrome	SB3CH
Four Gang 	Ivory	TP4I	SP4I	Aluminum	SA4
	White	TP4W	SP4W		
	Brown	TP4	SP4	Polished Brass	SB4PB
	Gray	TP4GRY	SP4GRY	430S/S	SL4
	Black	TP4BK		302/304 S/S	SS4
	Red	TP4RED			
	Light Almond	TP4LA	SP4LA		
Five Gang 	Ivory	TP5I	SP5I		
	White	TP5W	SP5W	Polished Brass	SB5PB
	Brown	TP5	SP5		
	Gray	TP5GRY	SP5GRY	302/304 S/S	SS5
	Black	TP5BK			
	Light Almond	TP5LA	SP5LA		
Six Gang 	Ivory	TP6I	SP6I		
	White	TP6W	SP6W	Polished Brass	SB6PB
	Brown	TP6			
	Gray	TP6GRY	SP6GRY	302/304 S/S	SS6
	Black	TP6BK			
	Light Almond	TP6LA	SP6LA		
Seven Gang 				302/304 S/S	SS601
				302/304 S/S Painted Ivory	SS601I
				302/304 S/S Painted White	SS601W
Eight Gang 				302/304 S/S	SS602
				302/304 S/S Painted Ivory	SS602I
				302/304 S/S Painted White	SS602W

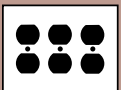
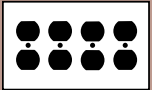
WALL PLATES

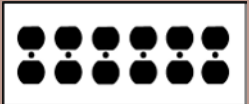

Duplex Receptacle & Decorator-Style Openings Standard Size Plastic & Metal

DESCRIPTION	COLOR	NYLON	THERMOSET	METAL	
		TRADEMASTER® PLATES	SMOOTH	MATERIAL	SMOOTH
DUPLEX RECEPTACLE OPENINGS					
One Gang 	Ivory	TP8I	SP8I	Aluminum	SA8
	White	TP8W	SP8W		
	Brown	TP8	SP8	Polished Brass 430S/S	SB8PB SL8
	Gray	TP8GRY	SP8GRY		
	Black	TP8BK			
	Red	TP8RED		302/304 S/S	SS8
	Light Almond	TP8LA	SP8LA		
	Blue	TP8BL		Brushed Bronze Chrome	SB8BZ SB8CH
	Orange	TP8OR			
Two Gang 	Ivory	TP82I	SP82I	Aluminum	SA82
	White	TP82W	SP82W		
	Brown	TP82	SP82	Polished Brass 430S/S	SB82PB SL82
	Gray	TP82GRY	SP82GRY		
	Black	TP82BK			
	Red	TP82RED		302/304 S/S	SS82
	Light Almond	TP82LA	SP82LA		
	Orange	TP82OR		Brushed Bronze Chrome	SB82BZ SB82CH
Three Gang 	Ivory		SP83I	Polished Brass	SB83PB
	White		SP83W		
	Brown		SP83	302/304 S/S	SS83
	Gray		SP83GRY		
	Light Almond		SP83LA		
Four Gang 	Ivory		SP84I	Polished Brass	SB84PB
	White		SP84W		
	Brown		SP84	302/304 S/S	SS84
	Gray		SP84GRY		
Five Gang 				302/304 S/S	SS85
Six Gang 				302/304 S/S	SS86
DECORATOR-STYLE OPENINGS					
One Gang 	Ivory	TP26I	SP26I	Aluminum	SA26
	White	TP26W	SP26W		
	Brown	TP26	SP26	Polished Brass 430S/S	SB26PB SL26
	Gray	TP26GRY	SP26GRY		
	Black	TP26BK	SP26BK		
	Red	TP26RED		302/304 S/S	SS26
	Light Almond	TP26LA	SP26LA		
	Blue	TP26BL		Brushed Bronze Chrome	SB26BZ SB26CH
	Orange	TP26OR			

These products listed to UL514, Cover Plates for Flush-Mounted Wiring Devices, CSA Certified.



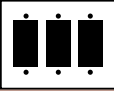

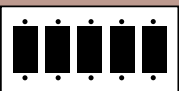
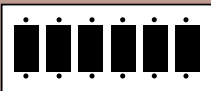
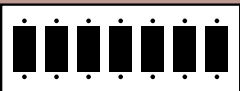
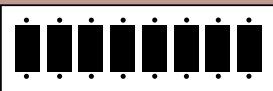

WALL PLATES

Decorator-Style Openings Standard Size Plastic & Metal

DESCRIPTION	COLOR	NYLON	THERMOSET	METAL	
		TRADEMASTER® PLATES	SMOOTH	MATERIAL	SMOOTH
DECORATOR-STYLE OPENINGS					
Two Gang 	Ivory	TP262I	SP262I	Aluminum	SA262
	White	TP262W	SP262W		
	Brown	TP262	SP262	Polished Brass	SB262PB
	Gray	TP262GRY	SP262GRY		
	Black	TP262BK	SP262BK		
	Red	TP262RED		430S/S	SL262
	Light Almond	TP262LA	SP262LA	302/304 S/S	SS262
	Blue	TP262BL			
	Orange	TP262OR			
Three Gang 	Ivory	TP263I	SP263I	Polished Brass	SB263PB
	White	TP263W	SP263W		
	Brown	TP263		302/304 S/S	SS263
	Gray	TP263GRY	SP263GRY		
	Black	TP263BK	SP263BK		
	Red	TP263RED			
	Light Almond	TP263LA	SP263LA		
Four Gang 	Ivory	TP264I	SP264I	Polished Brass	SB264PB
	White	TP264W	SP264W		
	Brown	TP264	SP264	302/304 S/S	SS264
	Gray	TP264GRY	SP264GRY		
	Black	TP264BK	SP264BK		
	Red	TP264RED			
	Light Almond	TP264LA	SP264LA		
Five Gang 	Ivory	TP265I	SP265I	302/304 S/S	SS265
	White	TP265W	SP265W		
	Brown	TP265		302/304 S/S	SS265
	Gray	TP265GRY	SP265GRY		
	Black	TP265BK	SP265BK		
	Red		SP265RED		
	Light Almond	TP265LA	SP265LA		
Six Gang 	Ivory	TP266I	SP266I	302/304 S/S	SS266
	White	TP266W	SP266W		
	Brown	TP266	SP266	302/304 S/S	SS266
	Gray	TP266GRY	SP266GRY		
	Black	TP266BK	SP266BK		
	Light Almond	TP266LA	SP266LA		
	Seven Gang 				302/304 S/S
				302/304 S/S Painted Ivory	SS267I
				302/304 S/S Painted White	SS267W
Eight Gang 				302/304 S/S	SS268
				302/304 S/S Painted Ivory	SS268I
				302/304 S/S Painted White	SS268W

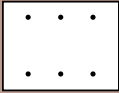
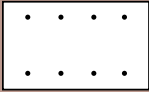
WALL PLATES

Blank Plates – Box Mounted Standard Size Plastic & Metal

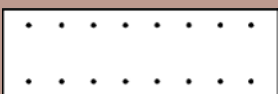

DESCRIPTION	COLOR	NYLON	THERMOSET	METAL	
		TRADEMASTER® PLATES	SMOOTH	MATERIAL	SMOOTH
BLANK PLATES – BOX MOUNTED					
One Gang Blank – Box Mtd. 	Ivory	TP13I	SP13I	Aluminum	SA13
	White	TP13W	SP13W		
	Brown	TP13	SP13	Polished Brass	SB13PB
	Gray	TP13GRY	SP13GRY	430S/S	SL13
	Black	TP13BK		302/304 S/S	SS13
	Red	TP13RED		302/304 S/S (1/2" Screws)	SS13.5
	Light Almond	TP13LA	SP13LA	Brushed Bronze	SB13BZ
			Chrome	SB13CH	
Two Gang Blank – Box Mtd. 	Ivory	TP23I	SP23I	Aluminum	SA23
	White	TP23W	SP23W		
	Brown	TP23	SP23	Polished Brass	SB23PB
	Gray	TP23GRY	SP23GRY	430S/S	SL23
	Black	TP23BK		302/304 S/S	SS23
	Light Almond	TP23LA	SP23LA	302/304 S/S (1/2" Screws)	SS23.5
				Brushed Bronze	SB23BZ
			Chrome	SB23CH	
Three Gang Blank – Box Mtd. 	Ivory		SP33I	Polished Brass	SB33PB
	White		SP33W		
	Brown		SP33	302/304 S/S	SS33
	Gray		SP33GRY	302/304 S/S (1/2" Screws)	SS33.5
	Light Almond		SP33LA		
Four Gang Blank – Box Mtd. 	Ivory		SP43I		
	White		SP43W		
	Brown		SP43	302/304 S/S	SS43
	Gray		SP43GRY		
Five Gang Blank – Box Mtd. 				302/304 S/S	SS53
Six Gang Blank – Box Mtd. 				302/304 S/S	SS63
Seven Gang Blank – Box Mtd. 				302/304 S/S	SS6013
Eight Gang Blank – Box Mtd. 				302/304 S/S	SS6023

WALL PLATES

These products listed to UL514, Cover Plates for Flush-Mounted Wiring Devices, CSA Certified.

WALL PLATES

Blank Plates – Strap Mounted Standard Size Plastic & Metal

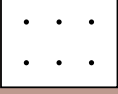
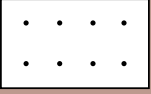
DESCRIPTION	COLOR	NYLON	THERMOSET	METAL	
		TRADEMASTER® PLATES	SMOOTH	MATERIAL	SMOOTH
BLANK PLATES – STRAP MOUNTED WITH ADJUSTMENT YOKE					
One Gang Blank – Strap Mtd. 	Ivory	TP14I	SP14I	Aluminum	SA14
	White	TP14W	SP14W		
	Brown	TP14	SP14	430S/S	SL14
	Gray	TP14GRY	SP14GRY		
	Black	TP14BK	SP14BK		
	Red		SP14RED	302/304 S/S	SS14
	Light Almond	TP14LA	SP14LA	302/304 S/S (1/2" Screws)	SS14.5
Two Gang Blank – Strap Mtd. 	Ivory	TP24I	SP24I	Aluminum	SA24
	White	TP24W	SP24W		
	Brown	TP24	SP24	430S/S	SL24
	Gray	TP24GRY	SP24GRY		
	Black	TP24BK	SP24BK		
	Red		SP24RED	302/304 S/S	SS24
	Light Almond	TP24LA	SP24LA	302/304 S/S (1/2" Screws)	SS24.5
Three Gang Blank – Strap Mtd. 	Ivory		SP34I	302/304 S/S	SS34
	White		SP34W		
	Brown		SS34		
	Gray		SP34GRY		
Four Gang Blank – Strap Mtd. 	Ivory		SP44I	302/304 S/S	SS44
	White		SP44W		
	Brown		SP44		
	Gray		SP44GRY		

WALL PLATES

Single Receptacle & Power Outlet Openings Standard Size Plastic & Metal



DESCRIPTION	COLOR	NYLON	THERMOSET	METAL	
		TRADEMASTER® PLATES	SMOOTH	MATERIAL	SMOOTH
SINGLE RECEPTACLE OPENINGS					
One Gang 	Ivory	TP71	SP71	Aluminum	SA7
	White	TP7W	SP7W		
	Brown	TP7	SP7	Polished Brass 430S/S 302/304 S/S	SB7PB SL7 SS7
	Gray	TP7GRY	SP7GRY		
	Black	TP7BK			
	Red	TP7RED			
Light Almond	TP7LA	SP7LA			
Two Gang 	Ivory		SP72I	302/304 S/S	SS72
	White		SP72W		
	Brown		SP72		
Three Gang 				302/304 S/S	SS73
				302/304 S/S Painted Ivory	SS73I
				302/304 S/S Painted White	SS73W
				302/304 S/S Painted Gray	SS73GRY
POWER OUTLET RECEPTACLE OPENINGS – ONE GANG					
 1.5938" hole for 1.5625" dia. device – 2 mtg. holes	Ivory	TP720I	SP720I	302/304 S/S	SS720
	White	TP720W	SP720W		
	Brown	TP720	SP720		
	Gray	TP720GRY	SP720GRY		
	Light Almond	TP720LA	SP720LA		
 1.625" hole for 1.5938" dia. device – 2 mtg. holes				302/304 S/S	SS721
 1.75" hole for 1.7186" dia. device – 2 mtg. holes				302/304 S/S	SS725
 2.125" hole for 2.094" dia. device – 2 mtg. holes				302/304 S/S	SS723
 2.156" hole for 2.125" dia. device – 2 mtg. holes	Ivory	TP724I	384I	Chrome 302/304 S/S	S384C SS724
	White	TP724W	384		
	Brown	TP724			
	Gray	TP724GRY			
	Black	TP724BK			
	Light Almond	TP724LA			

WALL PLATES

These products listed to UL514, Cover Plates for Flush-Mounted Wiring Devices, CSA Certified.







WALL PLATES

Power Outlet Receptacle Openings Standard Size Plastic & Metal

DESCRIPTION	COLOR	NYLON	THERMOSET	METAL	
		TRADEMASTER® PLATES	SMOOTH	MATERIAL	SMOOTH
POWER OUTLET RECEPTACLE OPENINGS – TWO GANG					
 <p>2.4688" hole for 2.375" dia. device – 4 mtg. holes</p>				Chrome 302/304 S/S	S3863C SS701
 <p>2.1563" hole for 2.125" dia. device – 2 mtg. holes</p>				302/304 S/S	SS702
 <p>2.1563" hole for 2.125" dia. device – 4 mtg. holes</p>	Ivory Ivory White Brown Brown Gray Black Light Almond	TP703I TP703W TP703 TP703GRY TP703BK TP703LA	SP703I 3862I SP703 3862	Chrome 302/304 S/S	S3862C SS703
 <p>2.2813" hole for 2.125" dia. device – 4 mtg. holes</p>				Aluminum 302/304 S/S	SA716 SS716
 <p>2.1563" hole for 2.125" dia. device – 4 mtg. holes</p>				302/304 S/S	SS705
 <p>1.5938" hole for 1.5625" dia. device – 2 mtg. holes</p>				302/304 S/S	SS710

WALL PLATES





Combination Openings Standard Size Plastic & Metal

DESCRIPTION	COLOR	NYLON	THERMOSET	METAL	
		TRADEMASTER® PLATES	SMOOTH	MATERIAL	SMOOTH
TOGGLE SWITCH & DUPLEX RECEPTACLE OPENINGS					
Two Gang 1 Toggle, 1 Duplex 	Ivory	TP18I	SP18I	Polished Brass	SB18PB
	White	TP18W	SP18W		
	Brown	TP18	SP18	302/304 S/S	SS18
	Gray	TP18GRY	SP18GRY		
	Black	TP18BK			
	Red	TP18RED			
Light Almond	TP18LA		SP18LA		
Three Gang 2 Toggles, 1 Duplex 	Ivory	TP28I	SP28I	Polished Brass	SB28PB
	White	TP28W	SP28W		
	Brown	TP28	SP28	302/304 S/S	SS28
	Gray	TP28GRY	SP28GRY		
	Black	TP28BK			
	Red	TP28RED			
Light Almond	TP28LA		SP28LA		
Four Gang 3 Toggles, 1 Duplex 	Ivory		SP38I	Polished Brass	SS38PB
	White		SP38W		
	Brown		SP38	302/304 S/S	SS38 SS38.5
	Gray		SP38GRY		
	Light Almond		SP38LA		
				302/304 S/S	SS48
				302/304 S/S Painted Ivory	SS48I
				302/304 S/S Painted White	SS48W
TOGGLE SWITCH & DECORATOR-STYLE OPENINGS					
Two Gang 1 Toggle, 1 Decorator-Style 	Ivory	TP126I	SP126I	Aluminum	SA126
	White	TP126W	SP126W		
	Brown	TP126	SP126	Polished Brass	SB126PB
	Gray	TP126GRY	SP126GRY		
	Black	TP126BK	SP126BK		
	Light Almond	TP126LA	SP126LA	302/304 S/S	SS126
Three Gang 2 Toggles, 1 Decorator-Style 	Ivory	TP226I	SP226I	302/304 S/S	SS226
	White	TP226W	SP226W		
	Brown	TP226	SP226	302/304 S/S	SS226
	Gray	TP226GRY	SP226GRY		
	Light Almond	TP226LA	SP226LA		
	Black	TP226BK			
Three Gang 1 Toggle, 2 Decorator-Style 	Ivory		SP1262I	302/304 S/S	SS1262
	White		SP1262W		
	Brown		SP1262	302/304 S/S	SS1262
	Gray		SP1262GRY		
	Black		SP1262BK		
	Light Almond		SP1262LA		
Four Gang 3 Toggles, 1 Decorator-Style 	Ivory		SP326I	302/304 S/S	SS326
	White		SP326W		
	Brown		SP326	302/304 S/S	SS326
	Gray		SP326GRY		
	Light Almond		SP326LA		

These products listed to UL514, Cover Plates for Flush-Mounted Wiring Devices, CSA Certified.









WALL PLATES

Combination Openings Standard Size Plastic & Metal

DESCRIPTION	COLOR	NYLON	THERMOSET	METAL	
		TRADEMASTER® PLATES	SMOOTH	MATERIAL	SMOOTH
TOGGLE SWITCH & DECORATOR-STYLE OPENINGS (CONT.)					
Four Gang 2 Toggles, 2 Decorator-Style 	Ivory White Brown Light Almond		SP2262I SP2262W SP2262 SP2262LA		
TOGGLE SWITCH & BLANK STRAP MOUNTED OPENINGS					
Two Gang 1 Toggle, 1 Blank 				302/304 S/S	SS114
Three Gang 2 Toggles, 1 Blank 				302/304 S/S	SS214
Four Gang 3 Toggles, 1 Blank 				302/304 S/S	SS314

WALL PLATES

Combination Openings Standard Size Plastic & Metal









DESCRIPTION	COLOR	NYLON	THERMOSET	METAL	
		TRADEMASTER® PLATES	SMOOTH	MATERIAL	SMOOTH
TWO GANG COMBINATION OPENINGS					
Two Gang 1 Toggle, 1 Single 	Ivory White Brown Gray		SP17I SP17W SP17 SP17GRY	302/304 S/S	SS17
Two Gang Single/Duplex 	Ivory White Brown Gray		SP78I SP78W SP78 SP78GRY	Aluminum 302/304 S/S	SA78 SS78
Two Gang Duplex/Decorator-Style 	Ivory White Brown Gray Black Red Light Almond	TP826I TP826W TP826 TP826GRY TP826BK TP826RED TP826LA	SP826I SP826W SP826 SP826GRY SP826LA	Polished Brass 302/304 S/S	SB826PB SS826
Two Gang Telephone/Toggle 	Ivory White Brown		SP112I SP112W SP112		
Two Gang Telephone/Duplex 	Ivory White Brown Gray		SP128I SP128W SP128 SP128GRY	302/304 S/S	SS128
Two Gang Telephone/Blank (Strap Mtd) 	Ivory White		SP1214I SP1214W	302/304 S/S	SS1214
Three Gang Telephone/Decorator-Style 	White Brown		SP1226W SP1226	302/304 S/S	SS1226
Four Gang Blank (Box Mtd)/Duplex 	Ivory White Brown Gray Black Red Light Almond	TP138I TP138W TP138 TP138GRY TP138BK TP138RED TP138LA	SP138I SP138W SP138 SP138GRY	302/304 S/S	SS138
Four Gang Toggle/Blank (Box Mtd) 	Ivory White Brown Gray Black Light Almond	TP113I TP113W TP113 TP113GRY TP113BK TP113LA		302/304 S/S	SS113



These products listed to UL514, Cover Plates for Flush-Mounted Wiring Devices, CSA Certified.

WALL PLATES









Combination Openings Standard Size Plastic & Metal

DESCRIPTION	COLOR	NYLON	THERMOSET	METAL	
		TRADEMASTER® PLATES	SMOOTH	MATERIAL	SMOOTH
TWO GANG COMBINATION OPENINGS (CONT.)					
Two Gang Blank (Strap Mtd) Duplex 	Ivory White Brown Gray		SP148I SP148W SP148 SP148GRY	302/304 S/S	SS148
Two Gang Blank (Strap Mtd)/Single 	Ivory White		SP147I SP147W	302/304 S/S	SS147
Two Gang Blank (Strap Mtd)/Decorator-Style 	Ivory White Brown Gray Light Almond		SP1426I SP1426W SP1426 SP1426GRY SP1426LA	302/304 S/S	SS1426
THREE & FOUR GANG COMBINATION OPENINGS					
Three Gang Toggle/Duplex/Duplex 	Ivory White Brown Gray Light Almond		SP182I SP182W SP182 SP182GRY SP182LA	Polished Brass 302/304 S/S	SB182PB SS182
Three Gang Blank (Strap Mtd)/Toggle/ Blank (Strap Mtd) 				302/304 S/S	SS8148
Two Gang Blank (Strap Mtd)/Toggle/ Blank (Strap Mtd) 				302/304 S/S	SS14114
Three Gang Telephone/Decorator-Style 				302/304 S/S	SS14814
Four Gang Blank (Box Mtd)/Duplex 				302/304 S/S	SS282

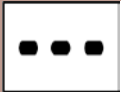
WALL PLATES

Despard® Openings

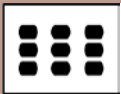
Standard Size Plastic & Metal Despard Interchangeable Plate Supplied with Mounting Straps







DESCRIPTION	NYLON		THERMOSET	METAL	
	COLOR	TRADEMASTER® PLATES	SMOOTH	MATERIAL	SMOOTH
ONE HORIZONTAL OPENING PER GANG					
One Gang 	Ivory White Brown		K11 K1W K1	302/304 S/S	SSK1
Two Gang 				302/304 S/S	SSK12
Three Gang 				302/304 S/S	SSK13
TWO HORIZONTAL OPENINGS PER GANG					
One Gang 	Ivory White Brown		K21 K2W K2	302/304 S/S	SSK2
Two Gang 				302/304 S/S	SSK22
THREE HORIZONTAL OPENINGS PER GANG					
One Gang 	Ivory White Brown		K31 K3W K3	302/304 S/S	SSK3
Two Gang 				302/304 S/S	SSK32
Three Gang 				302/304 S/S	SSK33
ONE VERTICAL OPENING PER GANG					
One Gang 	Ivory White Brown		K41 K4W K4		

See Page T-11 for Devices.

These products listed to UL514, Cover Plates for Flush-Mounted Wiring Devices, CSA Certified.





WALL PLATES

Two Gang with Center Opening Standard Size Metal

DESCRIPTION	COLOR	NYLON	THERMOSET	METAL	
		TRADEMASTER® PLATES	SMOOTH	MATERIAL	SMOOTH
ONE HORIZONTAL OPENING PER GANG					
Toggle Switch 				302/304 S/S	SS740
Blank-Box Mount 				302/304 S/S	SS743
Decorator-Style 				302/304 S/S	SS746
Single Receptacle 				302/304 S/S	SS747
Duplex Receptacle 				302/304 S/S	SS748
KL SERIES LOCKING SWITCH PLATES					
One Gang  <p>.906 diameter Reference Page A-5 for device</p>				302/304 S/S	SS717
Two Gang  <p>.906 diameter Reference Page A-5 for device</p>				302/304 S/S	SS727







WALL PLATES

Louwer & Biplex/Triplex Openings Standard Size Metal

DESCRIPTION	COLOR	NYLON	THERMOSET	METAL	
		TRADEMASTER® PLATES	SMOOTH	MATERIAL	SMOOTH
LOUVER PLATES					
One Gang Horizontal 				302/304 S/S 302/304 S/S Painted Ivory 302/304 S/S Painted White 302/304 S/S Painted Light Almond	SS760 SS760I SS760W SS760LA
One Gang Vertical 				302/304 S/S 302/304 S/S Painted Ivory 302/304 S/S Painted White 302/304 S/S Painted Brown 302/304 S/S Painted Gray 302/304 S/S Painted Light Almond	SS771 SS771I SS771W SS771X SS771GRY SS771LA
Two Gang Vertical 				302/304 S/S	SS772
BIPLEX/TRIPLEX RECEPTACLE					
One Gang 1 Biplex/Triplex 				302/304 S/S	SS9

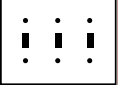
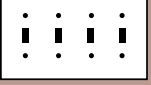
WALL PLATES

Toggle Switch, Duplex & Single Receptacle Openings Junior-Jumbo & Jumbo Plastic & Metal

DESCRIPTION	COLOR	NYLON	THERMOSET		METAL		
		TRADEMASTER®	JUNIOR-JUMBO	JUMBO	MATERIAL	JUNIOR-JUMBO	JUMBO
		JUMBO	SMOOTH	SMOOTH		SMOOTH	SMOOTH
TOGGLE SWITCH OPENINGS							
One Gang 	Ivory	TPJ1I	SPJ1I	SP01I	302/304 S/S	SSJ1	SS01
	White	TPJ1W	SPJ1W	SP01W			
	Brown	TPJ1	SPJ1	SP01			
	Gray	TPJ1GRY					
	Light Almond	TPJ1LA	SPJ1LA				
Two Gang 	Ivory	TPJ2I	SPJ2I	SP02I	302/304 S/S	SSJ2	SS02
	White	TPJ2W	SPJ2W	SP02W			
	Brown	TPJ2	SPJ2	SP02			
	Gray	TPJ2GRY					
	Light Almond	TPJ2LA	SPJ2LA				
Three Gang 	Ivory	TPJ3I	SPJ3I		302/304 S/S	SSJ3	SS03
	White	TPJ3W	SPJ3W				
	Brown	TPJ3	SPJ3				
	Gray	TPJ3GRY					
	Light Almond	TPJ3LA	SPJ3LA				
Four Gang 	Ivory	TPJ4I	SPJ4I		302/304 S/S		SS04
	White	TPJ4W	SPJ4W				
	Brown	TPJ4	SPJ4				
	Gray	TPJ4GRY					
	Light Almond	TPJ4LA	SPJ4LA				
DUPLEX RECEPTACLE OPENINGS							
One Gang 	Ivory	TPJ8I	SPJ8I	SP08I	302/304 S/S	SSJ8	SS08
	White	TPJ8W	SPJ8W	SP08W			
	Brown	TPJ8	SPJ8	SP08			
	Gray	TPJ8GRY					
	Light Almond	TPJ8LA	SPJ8LA	SP08LA			
Two Gang 	Ivory	TPJ82I	SPJ82I	SP082I	302/304 S/S	SSJ82	SS082
	White	TPJ82W	SPJ82W	SP082W			
	Brown	TPJ82	SPJ82	SP082			
	Gray	TPJ82GRY	SPJ82GRY				
	Light Almond	TPJ82LA	SPJ82LA				
Three Gang 					302/304 S/S		SS083
SINGLE RECEPTACLE OPENINGS							
One Gang 	Ivory	TPJ7I	SPJ7I		302/304 S/S	SSJ7	SS07
	White	TPJ7W	SPJ7W				
	Brown	TPJ7	SPJ7				
	Gray	TPJ7GRY					
	Light Almond	TPJ7LA	SPJ7LA				

WALL PLATES

Decorator-Style Openings & Blank Plates Junior-Jumbo & Jumbo Plastic & Metal









DESCRIPTION	COLOR	NYLON		THERMOSET		METAL		
		TRADEMASTER®		JUNIOR-JUMBO	JUMBO	MATERIAL	JUNIOR-JUMBO	JUMBO
		JUMBO	SMOOTH	SMOOTH	SMOOTH		SMOOTH	
DECORATOR-STYLE OPENINGS								
One Gang 	Ivory	TPJ26I	SPJ26I	SP026I	302/304 S/S	SSJ26	SS026	
	White	TPJ26W	SPJ26W	SP026W				
	Brown	TPJ26	SPJ26	SP026				
	Gray	TPJ26GRY						
	Red	TPJ26RED						
Two Gang 	Ivory	TPJ262I	SPJ262I	SP0262I	302/304 S/S	SSJ262	SS0262	
	White	TPJ262W	SPJ262W	SP0262W				
	Brown	TPJ262	SPJ262	SP0262				
	Gray	TPJ262GRY						
	Light Almond	TPJ262LA	SPJ262LA	SP0262LA				
Three Gang 	Ivory	TPJ263I	SPJ263		302/304 S/S	SSJ263		
	White	TPJ263W	SPJ263W					
	Brown	TPJ263	SPJ263					
	Gray	TPJ263GRY						
	Light Almond	TPJ263LA	SPJ263LA					
Four Gang 	Ivory	TPJ264I	SPJ264I					
	White	TPJ264W	SPJ264W					
	Brown	TPJ264	SPJ264					
	Gray	TPJ264GRY						
	Light Almond	TPJ264LA	SPJ264LA					
BLANK PLATES - BOX & STRAP MOUNTED								
One Gang Blank Box Mtd. 	Ivory	TPJ13I	SPJ13I	SP013I	302/304 S/S	SSJ13	SS013	
	White	TPJ13W	SPJ13W	SP013W				
	Brown	TPJ13	SPJ13	SP013				
	Gray	TPJ13GRY						
	Light Almond	TPJ13LA	SPJ13LA					
Two Gang Blank Box Mtd. 	Ivory			SP023I	302/304 S/S		SS023	
	White			SP023W				
	Brown			SP023				
Three Gang Blank Box Mtd. 					302/304 S/S		SS033	
One Gang Strap Mtd. 					302/304 S/S		SS014	
Two Gang Blank Strap Mtd. 					302/304 S/S		SS024	
Three Gang Blank Strap Mtd. 					302/304 S/S		SS034	

WALL PLATES

These products listed to UL514, Cover Plates for Flush-Mounted Wiring Devices, CSA Certified.

WALL PLATES

Combination Openings Junior-Jumbo & Jumbo Plastic & Metal





DESCRIPTION	COLOR	NYLON	THERMOSET		MATERIAL	METAL	
		TRADEMASTER®	JUNIOR-JUMBO	JUMBO		JUNIOR-JUMBO	JUMBO
		JUMBO	SMOOTH	SMOOTH		SMOOTH	SMOOTH
TWO GANG COMBINATION OPENINGS							
Two Gang Toggle/Duplex 	Ivory White Brown Gray Light Almond	TPJ18I TPJ18W TPJ18 TPJ18GRY TPJ18LA	SPJ18I SPJ18W SPJ18 SPJ18LA	SP018I SP018W SP018	302/304 S/S	SSJ18	SS018
Two Gang Toggle/Decorator-Style 	Ivory White Brown Gray Light Almond	TPJ126I TPJ126W TPJ126 TPJ126GRY TPJ126LA	SPJ126I SPJ126W SPJ126 SPJ126LA		302/304 S/S	SSJ126	SS0126
Two Gang Toggle/Blank (Strap Mtd) Supplied with 340 Yoke 					302/304 S/S		SS0114
Two Gang Toggle/Blank (Box Mtd.) 	Ivory White Brown Gray Light Almond	TPJ113I TPJ113W TPJ113 TPJ113GRY TPJ113LA	SPJ113I SPJ113W SPJ113	SP0113I SP0113			
Two Gang Blank (Box Mtd)/Duplex 	Ivory White Brown		SPJ138I SPJ138W SPJ138	SP0138I SP0138	302/304 S/S		SS0138
Two Gang Duplex/Decorator-Style 	Ivory White Brown Gray Light Almond	TPJ826I TPJ826W TPJ826 TPJ826GRY TPJ826LA	SPJ826I SPJ826W SPJ826LA				
Two Gang Blank/Decorator-Style 	Ivory White Brown		SPJ1426I** SPJ1426W** SPJ1426**	SP01326I* SP01326W* SP01326*			
Three Gang 2 Toggles/Duplex 					302/304 S/S		SS028

*Box mounted
 **Strap mounted





WALL PLATES

Sectional

Thermoplastic

DESCRIPTION	SEMI-JUMBO	
	COLOR	SMOOTH NYLON
SECTIONAL WALL PLATES – END SECTIONS		
Toggle Switch 	Ivory White Light Almond	PJSE1I PJSE1W PJSE1LA
Duplex Receptacle 	Ivory White Light Almond	PJSE8I PJSE8W PJSE8LA
Single Receptacle 	White	PJSE7W
Blank, Strap Mounted  supplied with #340 Yoke	Ivory White Light Almond	PJSE14I PJSE14W PJSE14LA
Decorator-Style 	Ivory White Light Almond	PJSE26I PJSE26W PJSE26LA

Thermoplastic

DESCRIPTION	SEMI-JUMBO	
	COLOR	SMOOTH NYLON
SECTIONAL WALL PLATES – CENTER SECTIONS		
Toggle Switch 	Ivory White Light Almond	PJSC1I PJSC1W PJSC1LA
Duplex Receptacle 	Ivory White Light Almond	PJSC8I PJSC8W PJSC8LA
Single Receptacle 	White	PJSC7W
Blank, Strap Mounted  supplied with #340 Yoke	Ivory White Light Almond	PJSC14I PJSC14W PJSC14LA
Decorator-Style 	Ivory White Light Almond	PJSC26I PJSC26W PJSC26LA

WALL PLATES

Tandem & Handy Box Plates

Features

- Tandem wall plates are ideal for curtain wall and movable partitions or wherever limited wiring exists.

DESCRIPTION	MATERIAL	CATALOG NUMBER
TANDEM WALL PLATES		
1-3/4" W x 6-1/8" H 2 Vertical Devices Supplied with #342 Strap	302/304 S/S	SSTK424



Features

- Handy Box Plates give a finished appearance and style to surface mounted boxes.
- Available in a decorator-style opening with a bright corrosion-resistant zinc-plated finish.
- Plate conceals rough edge of box.

	MATERIAL	CATALOG NUMBER
GALVANIZED STEEL HANDY BOX PLATES		
One Gang Decorator-Style/GFCI	Plated	SH26

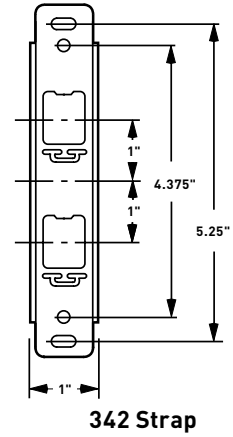

WALL PLATES

Narrow Metal Made to Order – Consult factory for price and availability

MADE TO ORDER WALL PLATES				
		1-3/4"	2"	
DECORATOR-STYLE OPENINGS	MATERIAL			
	Toggle Switch	302/304 S/S	SSN14	SSN15

Note: All narrow plates are 4-1/2" high.

WALL PLATES

Dustproof Stainless Steel Covers Specification Grade

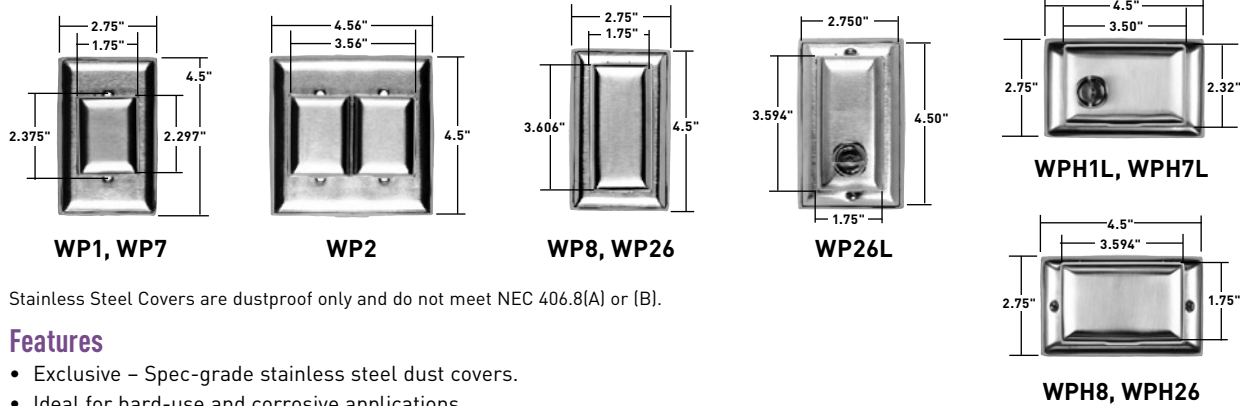

Stainless Steel Covers are dustproof only and do not meet NEC 406.8(A) or (B).

Features

- Exclusive – Spec-grade stainless steel dust covers.
- Ideal for hard-use and corrosive applications.
- Aesthetically pleasing.

CATALOG NUMBER	DESCRIPTION	3rd PARTY COMPLIANCE	
		UL	SR
DUSTPROOF STAINLESS STEEL COVERS			
WP1	1 Toggle Switch, 1 Small Cover, Vertical 1 Gang Plate. Available for Four Screw Mount – add suffix -FS	•	•
WP2	2 Toggle Switches 2 Small Covers, Vertical 2 Gang Plate	•	•
WP7	1 Single Receptacle 1 Small Cover, Vertical 1 Gang Plate Available for Four Screw Mount – add suffix -FS	•	•
WP8	1 Duplex Receptacle 1 Long Cover, Vertical 1 Gang Plate	•	•
WPH8	1 Duplex Receptacle 1 Long Cover, Horizontal 1 Gang Plate	•	•
WPD8	1 Duplex Receptacle 2 Small Covers, Horizontal 1 Gang Plate	•	•
WP26	1 Decorator-Style/GFCI 1 Long Cover, Vertical 1 Gang Plate	•	•
WPH26	1 Decorator-Style/GFCI 1 Long Cover, Horizontal 1 Gang Plate	•	•
DUSTPROOF LOCKING STAINLESS STEEL COVERS*			
WPH1L	Toggle Opening, Horizontal	•	•
WPH7L	Single Receptacle Opening, Horizontal	•	•
WPH8L	Duplex Receptacle Opening, Horizontal	•	•
WP26L	Decorator-Style/GFCI, Vertical	•	•

*Catalog Number WP255K – replacement key for all Dustproof Locking Covers. (Two keys furnished with each unit.)

Note: All locks keyed the same.

These products listed to UL514, Cover Plates for Flush-Mounted Wiring Devices, CSA Certified.

WALL PLATES

Communication Devices Telephone Wiring Devices

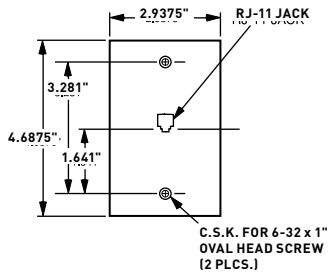

TPTE1

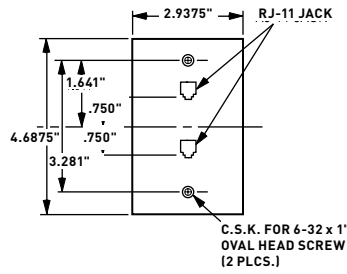

TPTE2

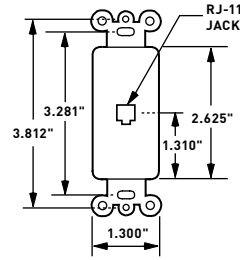

26TE14
26TE16

Features

- RJ11 modular jack.
- Mar-resistant wall plate.
- Wall plate dimension is Standard size.
- Fits standard size single gang electrical box.
- Meets FCC Part 68 requirements.

CATALOG NUMBER	DESCRIPTION	CONFIGURATION	3rd PARTY COMPLIANCE UL1863
SINGLE GANG OPENING MODULAR TELEPHONE JACK WITH WALL PLATE			
TPTE11	Ivory	4 Conductor	
TPTE1W	White	4 Conductor	
TPTE1	Brown	4 Conductor	
TPTE1GRY	Gray	4 Conductor	
TPTE1BK	Black	4 Conductor	
TPTE1LA	Light Almond	4 Conductor	
SINGLE GANG, TWO MODULAR RJ11 TELEPHONE JACKS WITH WALL PLATE			
TPTE21	Ivory	4 Conductor	
TPTE2W	White	4 Conductor	
TPTE2	Brown	4 Conductor	
TPTE2BK	Black	4 Conductor	
TPTE2LA	Light Almond	4 Conductor	

Features

- Decorator-style rectangular design.
- RJ11 modular jack.
- Fits standard single gang electrical box.
- May be used in multigang applications.
- Face constructed of high-impact thermoplastic.
- Brass terminals with nickel-plated steel screws and washers.
- Meets FCC Part 68 requirements.

CATALOG NUMBER	DESCRIPTION	CONFIGURATION	3rd PARTY COMPLIANCE UL1863
DECORATOR-STYLE MODULAR JACK SINGLE GANG, 1 OPENING MODULAR JACK			
26TE14I	Ivory	4 Conductor	•
26TE14W	White	4 Conductor	•
26TE14LA	Light Almond	4 Conductor	•
26TE16I	Ivory	6 Conductor	•
26TE16W	White	6 Conductor	•

WALL PLATES

Communication Devices Telephone Wiring Devices

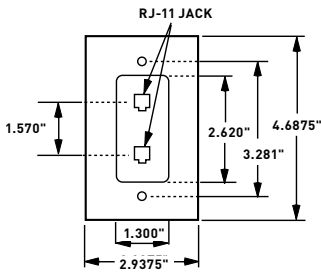

26TE24

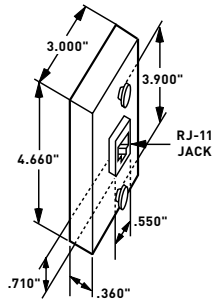

WMTE14

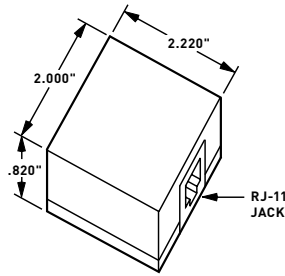

SMTE14

Features

- One piece molded plate decorator-style outline.
- Two RJ11 modular jacks.
- Fits standard single gang electrical box.
- Face constructed of high-impact thermoplastic.
- Brass terminals with nickel-plated steel screws and washers.
- Wall plate dimension is standard size.
- Meets FCC Part 68 requirements.

CATALOG NUMBER	COLOR	CONFIGURATION	3rd PARTY COMPLIANCE UL UL1863
DECORATOR-STYLE DUPLEX MODULAR JACK WITH SMOOTH PLATE SINGLE GANG, 2 OPENINGS			
26TE24I	Ivory	4 Conductor	•
26TE24W	White	4 Conductor	•
26TE24LA	Light Almond	4 Conductor	•
26TE26I	Ivory	6 Conductor	•
26TE26W	White	6 Conductor	•

Features

- RJ-11 modular jack.
- High-impact thermoplastic face plate and back body.
- Nickel-plated steel screw terminals.
- Zinc-plated mounting lugs.

CATALOG NUMBER	COLOR	CONFIGURATION	3rd PARTY COMPLIANCE UL UL1863
MODULAR WALL MOUNT TELEPHONE JACK FOR HANGING PHONES			
WMTE14I	Ivory	4 Conductor	•
WMTE14W	White	4 Conductor	•
WMTE14LA	Light Almond	4 Conductor	•

Features

- Nickel-plated steel screws and washers.
- Brass terminals.
- Comes with mounting screws and adhesive pad.
- Snap-on cover and base constructed of high-impact thermoplastic.

CATALOG NUMBER	COLOR	CONFIGURATION	3rd PARTY COMPLIANCE UL UL1863
SURFACE MOUNT MODULAR RJ-11 TELEPHONE JACK			
SMTE14I	Ivory	4 Conductor	•

WALL PLATES

Communication Devices Telephone & CATV Wiring Devices

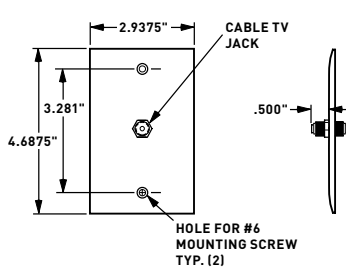

TPCATV

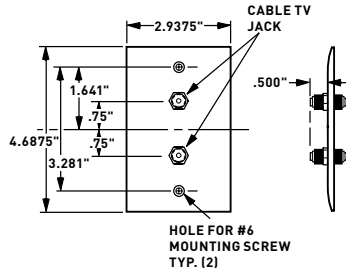

TPCATV2

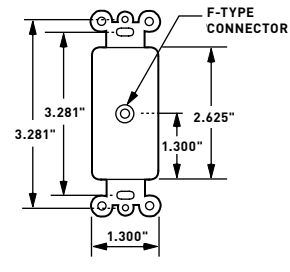

26CATV

Features

- Mar-resistant wall plate.
- Fits standard size single gang electrical box.
- Wall plate dimension is Standard size.
- Nickel-plated steel.
- Connector is threaded at each end.

CATALOG NUMBER	COLOR	CONFIGURATION	3rd PARTY COMPLIANCE UL1863
"F" TYPE WITH ONE COAXIAL CONNECTOR & WALL PLATE, SINGLE GANG			
TPCATVI	Ivory	F-type COAX Connector	•
TPCATVW	White	F-type COAX Connector	•
TPCATV	Brown	F-type COAX Connector	•
TPCATVBK	Black	F-type COAX Connector	•
TPCATVLA	Light Almond	F-type COAX Connector	•
"F" TYPE WITH TWO COAXIAL CONNECTORS & WALL PLATE, SINGLE GANG			
TPCATV2I	Ivory	2 F-type COAX Connectors	•
TPCATV2W	White	2 F-type COAX Connectors	•
TPCATV2	Brown	2 F-type COAX Connectors	•
TPCATV2BK	Black	2 F-type COAX Connectors	•
TPCATV2LA	Light Almond	2 F-type COAX Connectors	•

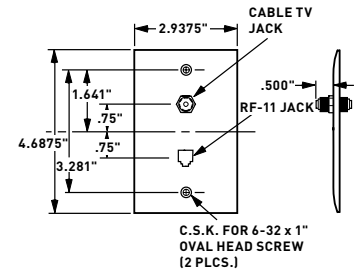

TPTELTV

Features

- Decorator-style outline.
- Face constructed of high-impact thermoplastic.
- Zinc-plated steel strap.
- Nickel-plated "F" type connector.
- Threaded on each end.

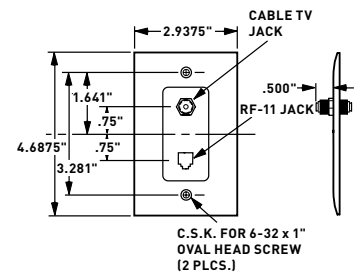

26TELVCC10

CATALOG NUMBER	COLOR	CONFIGURATION	3rd PARTY COMPLIANCE UL1863
DECORATOR-STYLE "F" TYPE COAXIAL CONNECTOR SINGLE GANG WITH 1 COAX CONNECTOR			
26CATVI	Ivory	F-type COAX Connector	•
26CATVW	White	F-type COAX Connector	•
26CATVLA	Light Almond	F-type COAX Connector	•

Features









- Decorator-style outline.
- RJ11 modular jack.
- Face constructed of high-impact thermoplastic.
- Zinc-plated steel strap.
- Nickel-plated "F" type connector.
- Threaded on each end.

CATALOG NUMBER	COLOR	CONFIGURATION	3rd PARTY COMPLIANCE UL1863
COMBINATION COAXIAL CONNECTOR & TELEPHONE JACK			
TPTELVI	Ivory		•
TPTELVW	White	F-type COAX Connector with	•
TPTELTV	Brown	4 Conductor RJ-11 jack	•
TPTELTVBK	Black		•
TPTELVLA	Light Almond		•
26TELVCC10	Ivory	Same as TPTELTV with	•
26TELVWCC10	White	one-piece molded plate	•
26TELVLACC10	Light Almond	decorator-style outline.	•

These products listed to UL514, Cover Plates for Flush-Mounted Wiring Devices, CSA Certified.







WALL PLATES

Communication Plates Standard Size Plastic & Metal

DESCRIPTION	COLOR	NYLON	THERMOSET	METAL	
		TRADEMASTER® PLATES	SMOOTH	MATERIAL	SMOOTH
TELEPHONE OR CABLE OUTLET 13/32" HOLE, BOX MOUNTED					
 One Gang 1 Outlet (Metal plates have removable 13/32" I.D. grommet in 17/32" hole.)	Ivory	TP111	SP111	302/304 S/S	SS11
	White	TP11W	SP11W		
	Brown	TP11	SP11		
	Gray	TP11GRY			
	Black	TP11BK			
	Red	TP11RED			
Light Almond	TP11LA				
 Two Gang 2 Outlets	Ivory		SP211	302/304 S/S	SS21
	White		SP21W		
	Gray		SP21GRY		
TELEPHONE OR CABLE OUTLET 13/32" HOLE, STRAP MOUNTED, WITH ADJUSTMENT YOKE					
 One Gang 1 Outlet, 1 #340 Yoke (Metal plates have removable 13/32" I.D. grommet in 17/32" hole.)	Ivory	TP121	SP121	430S/S 302/304 S/S	SL12 SS12
	White	TP12W	SP12W		
	Brown	TP12	SP12		
	Gray	TP12GRY			
	Black	TP12BK	SP12BK		
	Red	TP12RED	SP12RED		
Light Almond	TP12LA	SP12LA			
 Two Gang 2 Outlets				302/304 S/S	SS22
				302/304 S/S Painted Ivory	SS22I
				302/304 S/S Painted White	SS22W
				302/304 S/S Painted Gray	SS22GRY
TELEPHONE OR CABLE OUTLET 5/8" HOLE, STRAP MOUNTED					
 One Gang 1 Outlet 1 #340 Yoke (Metal plates have removable 13/32" I.D. grommet in 17/32" hole.)				302/304 S/S	SS730
TELEPHONE OR CABLE OUTLET 13/32" HOLE WITH KNOCKOUT, STRAP MOUNTED					
 One Gang 1 Outlet 1 #340 Yoke	Ivory		SP732I		
	Brown		SP732		
	Gray		SP732GRY		
TELEPHONE OR CABLE OUTLET 5/8" ID, BOX MOUNTED					
 One Gang 1 Outlet	Ivory	TP60I	SP60I		
	White	TP60W	SP60W		
	Light Almond	TP60LA	SP60LA		
TELEPHONE OR CABLE OUTLET 1 1/4" HOLE, STRAP MOUNTED					
 One Gang 1 Outlet Supplied With #340 Yoke				302/304 S/S	SS736

WALL PLATES

Communication Plates









DESCRIPTION	MATERIAL	CATALOG
HORIZONTAL-SPLIT WALL PLATES FOR TELEVISION OR CABLE LEAD-IN*		
 <p>One Gang 1 Outlet</p> <p>Box Mounted. Removable 13/32" I.D. grommet in 1/2" hole.</p>	302/304 S/S	SS751
 <p>One Gang 1 Outlet</p> <p>Strap Mounted. Removable 13/32" I.D. grommet in 17/32" hole.</p>	302/304 S/S	SS752
 <p>One Gang 1 Outlet</p> <p>Box Mounted. Removable 5/8" I.D. grommet in 7/8" hole.</p>	302/304 S/S	SS753
 <p>One Gang 1 Outlet</p> <p>Strap Mounted. Removable 5/8" I.D. grommet in 7/8" hole.</p>	302/304 S/S	SS754
 <p>One Gang 1 Outlet</p> <p>[Also Furnished for Strap Mounting Cat. #SS786 with 2 #340 Yokes. Box Mounted. Removable 13/32" I.D. grommet in 17/32" hole.]</p>	302/304 S/S**	SS785
 <p>Two Gang 1 Centered Outlet</p> <p>[Also Furnished for Strap Mounting Cat. #SS788 with 2 #340 Yokes. Box Mounted. Removable 5/8" I.D. grommet in 7/8" hole.]</p>	302/304 S/S**	SS787

*For telephone, security systems, FM and cable TV antennas or wherever cable interconnections are required.



**Strap Mounted with 2 #340 Yokes.

WALL PLATES

Communication Plates

DESCRIPTION	COLOR	THERMOSET	METAL	
		SMOOTH	MATERIAL	SMOOTH
TWO GANG WITH CENTERED OPENINGS**				
 1 Centered Outlet Box Mounted			302/304 S/S	SS741
 1 Centered Outlet Strap Mounted Supplied with #340 Yoke			302/304 S/S	SS742
COMPUTER JACK PLATES FOR RS-232 CONNECTORS**				
 One Gang One Jack Opening			302/304 S/S	SS791
 One Gang Two Jack Opening			302/304 S/S	SS792
STANDARD COMBINATION TWO GANG*				
 Two Gang Telephone/Duplex	Ivory White Brown Gray	SP128I SP128W SP128 SP128GRY	302/304 S/S	SS128
 Two Gang Telephone/Blank (Strap Mtd)	Ivory White	SP1214I SP1214W	302/304 S/S	SS1214
 Two Gang Telephone/ Decorator-Style	White Brown	SP1226W SP1226	302/304 S/S	SS1226
 Two Gang Telephone/Toggle	Ivory White Brown	SP112I SP112W SP112		

*Has 13/32" and 5/8" double knockout.

DESCRIPTION	THERMOSET		METAL	
	COLOR	SMOOTH	JUNIOR-JUMBO	
			MATERIAL	SMOOTH
TELEPHONE/CABLE OUTLET**				
 One Gang 1 Outlet <small>(Metal plates have removable 13/32" I.D. grommet in 17/32" hole.)</small>	Ivory White Light Almond	SPJ11I SPJ11W SPJ11LA	302/304 S/S	SS011
 One Gang 1 Outlet Supplied with #340 Yoke			302/304 S/S	SS012

**These products listed to UL514, Cover Plates for Flush-Mounted Wiring Devices, CSA Certified.

SPECIALTIES

Mounting Straps, Yokes & Jewels

DESCRIPTION	FINISH	COLOR	CATALOG NUMBER	DIMENSIONS
GALVANIZED STEEL HANDY BOX PLATES				
Mounting strap for dimmer insert. Box mounted. Change from decorator-style to toggle opening.	Painted Steel	Ivory	327I	
		White	327W	
		Brown	327	
		Light Almond	327LA	
Mounting strap for blank insert. Box mounted. Change decorator-style opening to blank.	Painted Steel	Ivory	326I	
		White	326W	
		Brown	326	
		Light Almond	326LA	
Tandem mounting strap with two vertical openings. Plate screw hole spacing 4-3/8".	Bright Zinc		342	
Mounting strap with three horizontal openings. Plate screw hole spacing 3-13/16". Box mounted.	Bright Zinc	Ivory	348I	
		White	348W	
		Brown	348	
		Light Almond	348LA	
Mounting strap with single vertical opening. Plate screw hole spacing 3-13/16". Box mounted.	Bright Zinc		347	
Adjustment yoke for strap mounted telephone and blank wall plates. Slots 3-9/32" C to C. Plate screw holes 2-3/8" C to C. Box mounted.	Bright Zinc	Ivory	340I	
		White	340W	
		Brown	340	
		Light Almond	340LA	
Mounting strap for blank insert. Changes toggle opening to blank, box mounted.	Thermoset	Ivory	80700I	
		White	80700W	
		Light Almond	80700LA	

	JEWEL COLOR	CATALOG NUMBER	JEWELS		JEWELS SHOWN WITH WALL PLATES
			FRONT VIEW	SIDE VIEW	
PLASTIC JEWELS - FOR TOGGLE SWITCH OPENINGS (STYLE #1)					
Rectangular acrylic plastic warning light jewel for toggle switch plates with holding ring. Red Jewel Standard.	Red	406RED			
	Green	406GN			
	White	406W			
PLASTIC JEWELS - FOR SINGLE RECEPTACLE OPENINGS (STYLE #7)					
Round acrylic plastic warning light jewel for single receptacle plates with holding ring. Red Jewel Standard.	Red	405RED			
	Green	405GN			
	White	405W			

UL Listed.

WALL PLATES

WALL PLATES & SPECIALTIES

Incandescent Lampholders, Neon Pilot Lights

Incandescent Lampholders



Designed to give adequate light when installed behind a louvre plate or indicator jewel. Mounts in standard wall box. Plate mounting is 2-3/8" and 3-13/16". UL listed for 120 VAC circuits. Plate not included.

Description **Catalog Number**
Standard lampholder, 4 Watt **2152**

Extra long life: Integral series resistor in base reduces light output by about 40%, but increases lamp life more than ten times. Plate not included.

Extra long life, 4 Watt **2156**

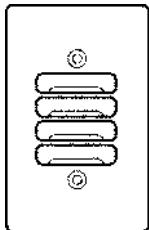

Application

Lampholders and louver plates are an ideal combination for providing bright, shielded light in hallways and pathways. They increase safety in corridors, theater aisles, porches, stairways, etc. A wide choice of plates gives unlimited possibilities for designing the perfect night light installation. Available in custom-painted stainless steel and stainless steel.

For the complete listing of Louver Plates, see Page S-21.

Neon Pilot Lights



Long life neon bulb emits indicating light through transparent lens to show power is on. May be installed at the load, at switching posts or at remote locations. We suggest the wall plate be engraved to explain indication. Fits standard wall box and takes standard toggle switch plate opening. Plate mounting is 2-3/8". UL listed 120/277 VAC.

Description **Catalog Number**

With green lens **2151GN**

With red lens **2151RED**

With white lens **2151W**

Energy Efficient Gasket

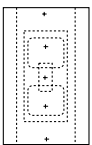













Description **Catalog Number**

Gangable gasket, use for toggle, duplex, GFCI or blank. **GASKET1**

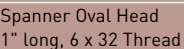

SPECIALTIES

Screws & Screwdrivers

DESCRIPTION	COLOR OR FINISH	CATALOG NUMBER
STANDARD & INTERCHANGEABLE WALL PLATE SCREWS		
Oval Head Milled Slot 5/16" long, 6 x 32 Thread   Standard size for Decorator-Style Wall Plates.	Ivory White Brown Gray Light Almond Stainless	509I 509W 509 509GRY 509LA 509S
Oval Head Milled Slot 1/2" long, 6 x 32 Thread   Standard size for Duplex Receptacles and Toggle Switch Wall Plates.	Ivory White Brown Brass Stainless	510I 510W 510 510BR 510S
Oval Head Milled Slot 3/4" long, 6 x 32 Thread   	Ivory White Brown Light Almond Stainless	511I 511W 511 511LA 511S
Oval Head Milled Slot 1" long, 6 x 32 Thread   Standard size for Blank Box Mounted Wall Plates.	Ivory White Brown Light Almond Stainless	512I 512W 512 512LA 512S
Oval Head Milled Slot 1-1/2" long, 6 x 32 Thread  	Ivory White Brown Light Almond Stainless	513I 513W 513 513LA 513S

DESCRIPTION	FINISH	CATALOG NUMBER
TAMPER-PROOF SPANNER HEAD SCREWS		
Spanner Oval Head 1/2" long, 6 x 32 Thread  	430S/S	531S
Spanner Oval Head 1" long, 6 x 32 Thread  	430S/S	532S

DESCRIPTION	CATALOG NUMBER
SCREWDRIVER FOR SPANNER HEAD OR KEY SLOT SCREWS	
Screwdriver for Spanner Head Screw 	533D

DESCRIPTION	FINISH	CATALOG NUMBER
NYLON SCREWS FOR STANDARD AND INTERCHANGEABLE WALL PLATES		
Oval Head Standard Slot 1/2" long, 6 x 32 Thread  	Ivory	528I

Notes:

- Specify screws by catalog number to designate type of screw, thread, length, color or finish required.
- Screws are available by the box only.
- Order by number of boxes...not by the quantity of screws.
- Each box contains 100 screws.
- Metal screws are available with special finishes and can be painted.

WALL PLATES

Engraved & Pad Printed

ENGRAVED (1/8" CHARACTERS)					
	DESCRIPTION	PLATE COLOR	FILL COLOR	NYLON TRADEMASTER®	METAL SMOOTH
EMERGENCY					
	1 Gang Duplex	302/304 S/S	Black		SS8EE
	1 Gang Duplex	302/304 S/S Painted Red	Black		SS8ERED

PAD PRINTED (1/8" CHARACTERS)					
	DESCRIPTION	PLATE COLOR	FILL COLOR	NYLON TRADEMASTER®	METAL SMOOTH
ISOLATED GROUND					
	1 Gang Duplex	Orange	Black	TP8IG	
	1 Gang Duplex	302/304 S/S	Black		SS8IG
	2 Gang Duplex	302/304 S/S	Black		SS82IG
	1 Gang Single	Orange	Black	TP7IG	
	1 Gang Decorator-Style	Orange	Black	TP26IG	
	1 Gang Decorator-Style	302/304 S/S	Black		SS26IG
EMERGENCY					
	1 Gang Duplex	Ivory	Red	TP8EI	
	1 Gang Duplex	White	Red	TP8EW	
	1 Gang Duplex	Red	Black	TP8ERED	
	1 Gang Duplex	302/304 S/S	Black		SS8ES
	2 Gang Duplex	Red	Black	TP82ERED	
	1 Gang Toggle	Red	Black	TP1ERED	
	2 Gang Toggle	Red	Black	TP2ERED	

WALL PLATES

Engraved & Pad Printed

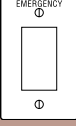
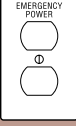
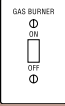
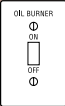
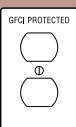
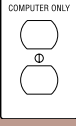
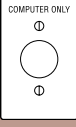
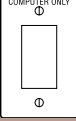
PAD PRINTED (1/8" CHARACTERS)					
	DESCRIPTION	PLATE COLOR	FILL COLOR	NYLON TRADEMASTER®	METAL SMOOTH
EMERGENCY					
	1 Gang Decorator-Style	Red	Black	TP26ERED	
	1 Gang Duplex	Red	Black	TP8EMPOWER	
GAS BURNER ON/OFF EMERGENCY SWITCH					
	1 Gang Toggle	302/304 S/S Painted Red	Black		SS1GBRED
OIL BURNER ON/OFF EMERGENCY SWITCH					
	1 Gang Toggle	302/304 S/S Painted Red	Black		SS1GBRED
GFCI PROTECTED					
	1 Gang Duplex	Ivory	Black	TP8GFI	
	1 Gang Duplex	White	Black	TP8GFW	
COMPUTER ONLY					
	1 Gang Duplex	Ivory	Black	TP8CI	
	1 Gang Duplex	Orange	Black	TP8CO	
	Single Receptacle	Ivory	Black	TP7CI	
	Single Receptacle	Orange	Black	TP7CO	
	1 Gang Decorator-Style	Ivory	Black	TP26CI	
	1 Gang Decorator-Style	Blue	Black	TP26CBL	
	1 Gang Decorator-Style	Orange	Black	TP26CO	

WALL PLATES

Custom Metal Wall Plates Ordering Instructions

Ordering Instructions:

1. Using the following charts, fill in the spaces provided to select the proper material, number of gangs, desired finish and color.

Review Your Requirements:	For Example:	Write Your Selection:	Space #
Material Prefix Code (Chart A below) For Jr. Jumbo Size add "J" after prefix, if Jumbo Size, add "O" after Prefix	SSO		1
Total Number of Gangs Ordered	4		2
Paint Finish Suffix (Chart B - Page S-41)	BLU		4
Metal Finish Suffix (Chart C - Page S-41)	BC		5

MATERIAL	PREFIX CODE
CHART A: MATERIAL SELECTION	
Aluminum*	SA
302/304 Stainless Steel	SS

*Standard size only.

2. Review the Plate Opening Styles on pages S-45 – S-57. Following the sequence of your installation (left to right), label each box below with the appropriate Opening Style Number for each gang.

Gang: 1	2	3	4	5	6	7	8	9	10

3. Create the Complete Order Part Number by filling in items from previous steps in spaces below.

- Space #1-Material Prefix Code (from step 1)
- Space #2-Total Number of Gangs (from step 1)
- Space #3-Style Numbers In Order (from step 2)
- Space #4-Metal Finish Suffix (from step 1)
- Space #5-Paint Finish Suffix (from step 1)

Catalog # _____ G _____ Style _____ - _____ - _____ - _____ - _____ - _____ - _____ - _____ - _____ - _____ - _____
 Space # 1 2 3 3 3 3 3 3 3 3 3 3 4 5

METAL PLATE	STANDARD	JR. JUMBO	JUMBO
MAXIMUM GANGS FOR CUSTOM METAL WALL PLATES			
Stainless (302)	20	3	20
Aluminum	8	N/A	N/A

WALL PLATES

Custom Metal Wall Plates Special Configurations

Chart B: Paint Finish Selection

These charts are for Custom Metal Wall Plates ONLY.
For Devices & Wall Plates Color Selection Charts, see Pages A-29, B-87 and S-58.



PAINT COLOR	Orange	Green	Gray	Yellow
PAINT SUFFIX	ORG	GRN	GRY	YFI

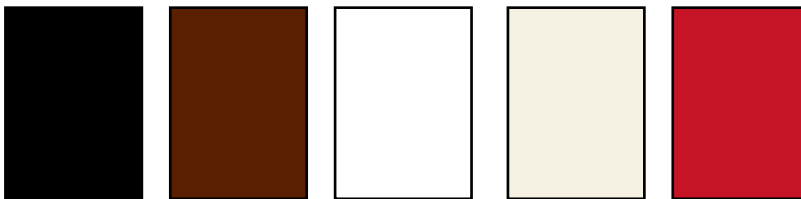

PAINT COLOR	Glossy Black	Brown	White	Primer	Red
PAINT SUFFIX	GBK	BRO	WHT	PRI	RED

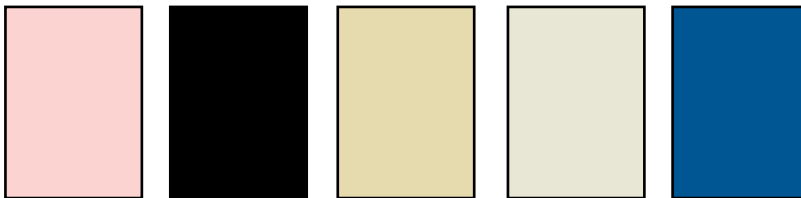

PAINT COLOR	Pink	Flat Black	Ivory	Light Almond	Blue
PAINT SUFFIX	PNK	FBK	IVY	LTA	MBL

Only available on Stainless Steel and Aluminum Plate Material. Colors may vary slightly.
All Paint Finishes are gloss, except primer and flat black.

Chart C: Metal Finish Selection



METAL FINISH	Polished Brass US #3	Bright Chromium US #26	Brushed Copper	Brushed Bronze US #10
FINISH SUFFIX	PB*	CH	BC	BZ

*Order with Brass Plate Material Prefix Only.
For additional colors consult factory.

WALL PLATES

Custom Metal Wall Plates Engraving & Pad Printing

Custom Engraving & Pad Printing

Most plates in this catalog can be engraved or pad printed. However, engraving plated finish metal plates is not recommended, since exposed edges could oxidize over time. Refer to current price sheet to select the better process that suits your needs.

Position

Marking may appear anywhere on the flat surface of smooth plates.

On decorator-style plates, markings are restricted to the top and bottom flat panels.

If space permits, up to three lines can be pad printed on a plate provided the lettering fits within a 50mm circle.

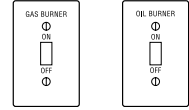

Letter Height

Unless specified otherwise, designers will select size and position of letters or markings for maximum legibility. Characters per inch:

3/8" - 2-1/2 1/4" - 4 3/16" - 6 1/8" - 9 1/16" - 14

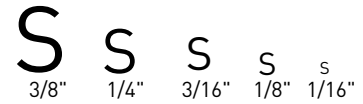

Letter Font

Pad printing is available in any True Type font in colors listed below, on 1 gang and 2 gang plates. Bitmap images can also be printed.

Laser engraving is available in any True Type font only in black (not color-filled) including bitmap images.

Engraving with color fill is available only in block letter font. While mixing of laser and color-filled engraving is allowed, it is not recommended since the font types will not match.

Color

Color-filled engraving can be filled with red, orange, black, blue, or white paint.

Standard colors for pad printing are red, black, blue, green, orange or white, as shown below.



Red Black Blue Green Orange White

Ordering Instructions

Specify clearly the following information when you order.

- | | |
|---|---|
| 1. Catalog number of plate(s). | 4. Position and size. |
| 2. To be engraved or pad printed. | 5. Color of filler, or pad printing. |
| 3. Letters, numbers, characters required. | 6. Special layout information, if applicable. |

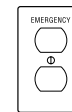

Position
Height of Mark
Color of Filler
Plate Style
by Catalog Number
Including
Color/Finish

WALL PLATES

Custom Panel Plates Ordering Instructions

Blank panel plates (PP-series) up to 5-gangs high and 10-gangs wide are made from Type 302/304 Stainless Steel. Up to 50 openings from the style selector guide can be custom punched to your specifications. For uniformity of design throughout the building, panel plates have the same distinctive styling as all other plates, plastic and metal.

Ordering Instructions

For this example, use the 4 gang high by 2 gang wide panel plate illustrated in Figure 2.

1. Start the catalog number with the material prefix: "SS" for Type 302/304 Stainless. This is a 302/304 Stainless plate, so the first letters of its catalog number will be "SS."
2. Determine the catalog number for a panel plate 4 gangs high and 2 gangs wide from the table on page S-44. It is PP-4-2. Your 302/304 Stainless Steel catalog number is SSPP-4-2.
3. Construct a chart upon which you can indicate the opening style number for each of the 8 gangs, starting from the top left. Leave space to show any words or symbols that will be engraved. Write the catalog number SSPP-4-2 at the top of the chart. See Figure 1.
4. Refer to the Style Selector Guide and find the style numbers for each of the desired openings. Write these numbers in their appropriate position on your chart.
5. Indicate what, if any, engraving is required for each gang. Show in parentheses if engraving is to be above or below the opening.
6. Send the chart with your order to the factory. You have provided all required information. Refer to current price sheet for pricing details.

Additional Information

- Where no opening or mounting holes are required, specify Style #149.
- Louvered openings can be placed only on the top row of a panel plate.
- For painted or special metal finishes, refer to price sheet for price adds per gang.
- For special openings not in Selector Guide, provide detailed drawing.

Example		
SSPP-4-2		
ROW #1:		
Style Nos.	1	1
Engraving:	ALTAR (Above)	CHOIR (Above)
ROW #2:		
Style Nos.	9	9
Engraving:	(None)	(None)
ROW #3:		
Style Nos.	12	12
Engraving:	(None)	TEL (Above)
ROW #4:		
Style Nos.	16	16
Engraving:	(None)	120V. (Above)

Figure 1

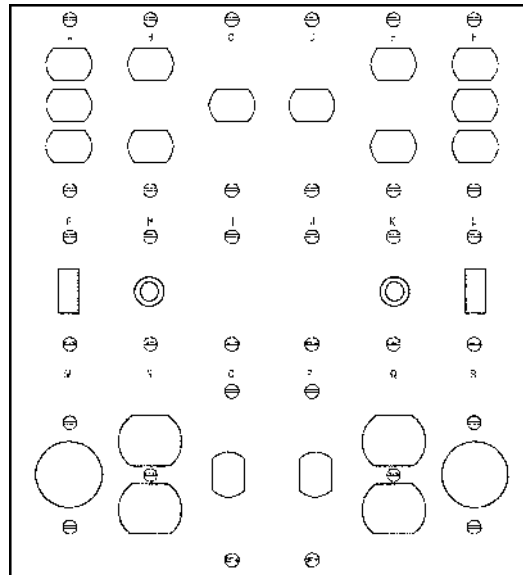

Custom Panel Plate

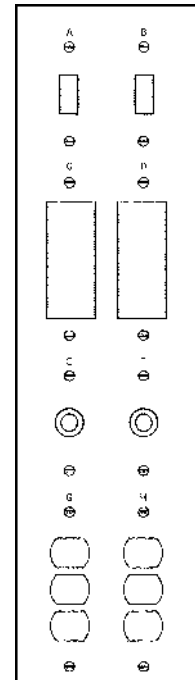

Figure 2

WALL PLATES

Custom Panel Plates Ordering Instructions

Wall Box Dimensions

Panel Plates are limited to fit the box configuration shown.

Caution: Not all boxes are identical in overall dimensions, but are built to exact standards on device mounting holes. When boxes are connected together, they should be shimmed to ensure that the bottom hole to bottom hole dimension between two vertically adjacent boxes is 4-1/8" as errors are cumulative. Critical dimensions circled.

If additional mounting holes are required in the corners, indicate location and spacing.

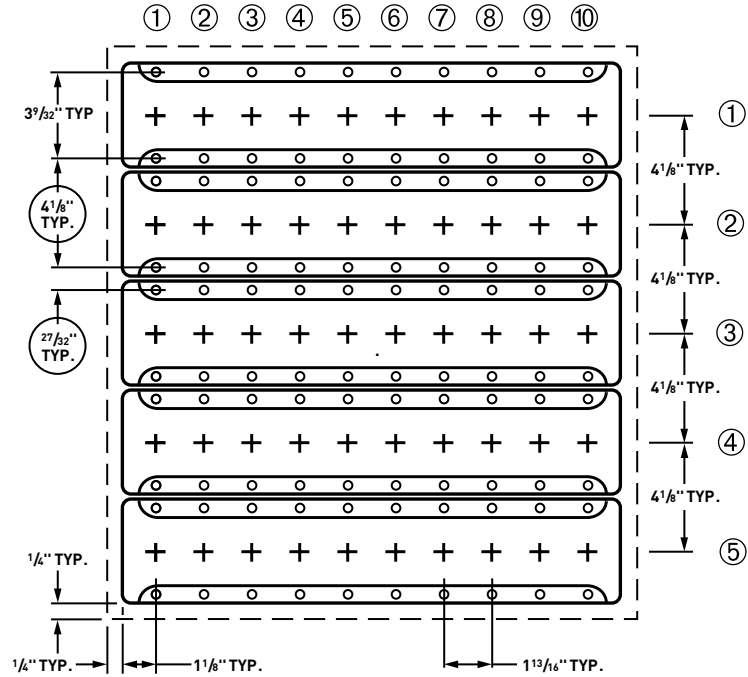

302/304 Stainless Steel

PLATE HEIGHT	CATALOG NUMBER	GANGS WIDE	PLATE WIDTH	PLATE HEIGHT	CATALOG NUMBER	GANGS WIDE	PLATE WIDTH
Two Gangs High 8-3/4"	PP21	One	2-3/4"	Four Gangs High 17"	PP41	One	2-3/4"
	PP22	Two	4-9/16"		PP42	Two	4-9/16"
	PP23	Three	6-3/8"		PP43	Three	6-3/8"
	PP24	Four	8-3/16"		PP44	Four	8-3/16"
	PP25	Five	10"		PP45	Five	10"
	PP26	Six	11-13/16"		PP46	Six	11-13/16"
	PP27	Seven	13-5/8"		PP47	Seven	13-5/8"
	PP28	Eight	15-7/16"		PP48	Eight	15-7/16"
	PP29	Nine	17-1/4"		PP49	Nine	17-1/4"
	PP210	Ten	19-1/16"		PP410	Ten	19-1/16"
Three Gangs High 12-7/8"	PP31	One	2-3/4"	Five Gangs High 21-1/8"	PP51	One	2-3/4"
	PP32	Two	4-9/16"		PP52	Two	4-9/16"
	PP33	Three	6-3/8"		PP53	Three	6-3/8"
	PP34	Four	8-3/16"		PP54	Four	8-3/16"
	PP35	Five	10"		PP55	Five	10"
	PP36	Six	11-13/16"		PP56	Six	11-13/16"
	PP37	Seven	13-5/8"		PP57	Seven	13-5/8"
	PP38	Eight	15-7/16"		PP58	Eight	15-7/16"
	PP39	Nine	17-1/4"		PP59	Nine	17-1/4"
	PP310	Ten	19-1/16"		PP510	Ten	19-1/16"

WALL PLATES

Style Selector Guide Custom Metal Wall Plates

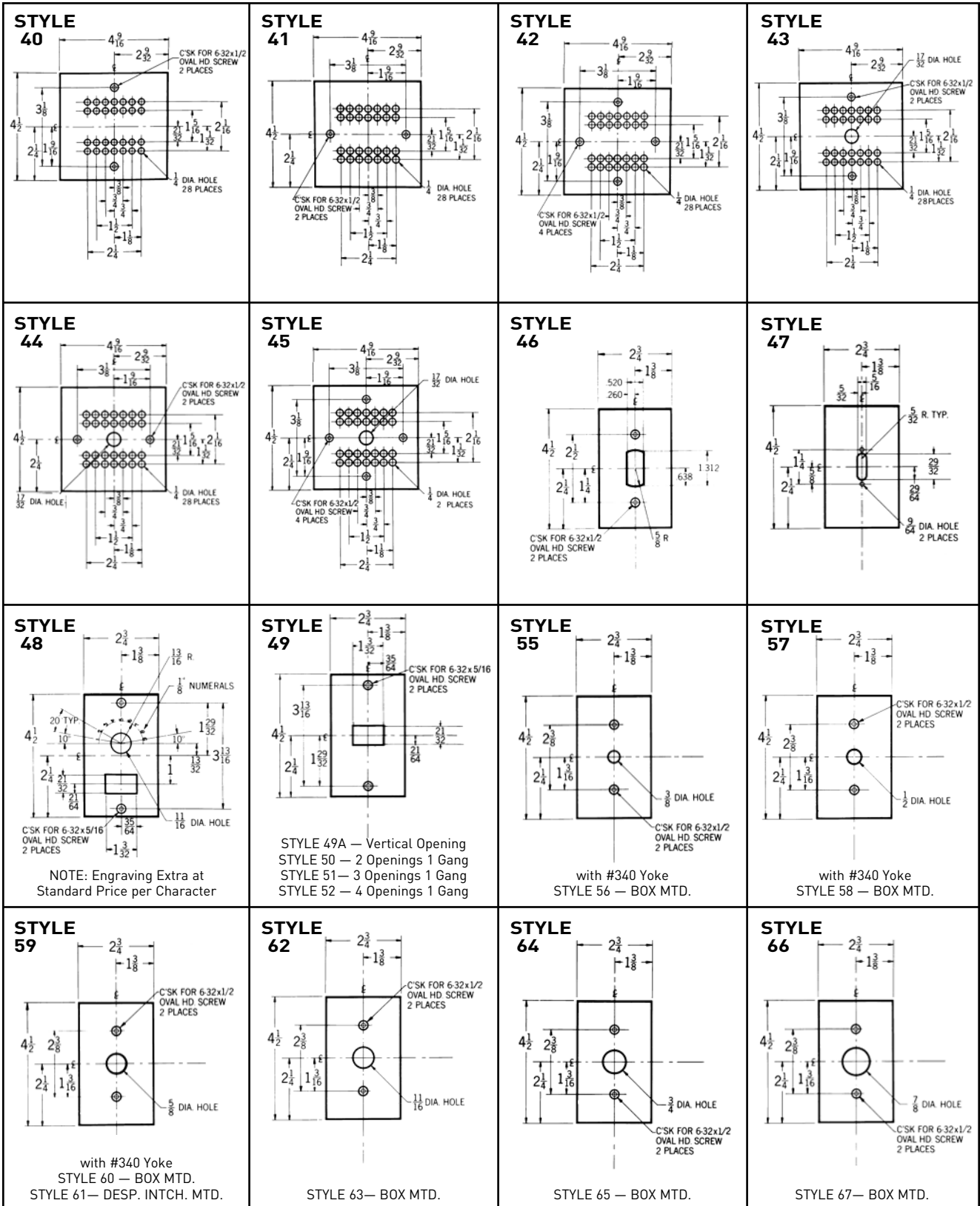

All wall plate dimensions shown above are in inches.

WALL PLATES

Style Selector Guide Custom Metal Wall Plates

<p>STYLE 68</p> <p>C'SK FOR 6-32x1/2 OVAL HD SCREW 2 PLACES</p> <p>1 5/16 DIA. HOLE</p> <p>STYLE 69 — BOX MTD. STYLE 70 — DESP. INTCH. MTD.</p>	<p>STYLE 71</p> <p>C'SK FOR 6-32x1/2 OVAL HD SCREW 2 PLACES</p> <p>1 DIA. HOLE</p> <p>STYLE 72 — BOX MTD.</p>	<p>STYLE 73</p> <p>C'SK FOR 6-32x1/2 OVAL HD SCREW 2 PLACES</p> <p>1 1/8 DIA. HOLE</p> <p>STYLE 74 — BOX MTD.</p>	<p>STYLE 75</p> <p>C'SK FOR 6-32x1/2 OVAL HD SCREW 2 PLACES</p> <p>1.136 DIA. HOLE</p> <p>Clearance for 11/8" Device STYLE 76 — BOX MTD.</p>
<p>STYLE 77</p> <p>C'SK FOR 6-32x1/2 OVAL HD SCREW 2 PLACES</p> <p>1 13/64 DIA. HOLE</p> <p>STYLE 78 — BOX MTD. STYLE 79 — DESP. INTCH. MTD.</p>	<p>STYLE 80</p> <p>C'SK FOR 6-32x1/2 OVAL HD SCREW 2 PLACES</p> <p>1 5/16 DIA. HOLE</p> <p>STYLE 81 — BOX MTD. STYLE 82 — DESP. INTCH. MTD.</p>	<p>STYLE 83</p> <p>C'SK FOR 6-32x1/2 OVAL HD SCREW 2 PLACES</p> <p>1 3/8 DIA. HOLE</p> <p>STYLE 84 — BOX MTD. STYLE 85 — DESP. INTCH. MTD.</p>	<p>STYLE 86</p> <p>C'SK FOR 6-32x1/2 OVAL HD SCREW 2 PLACES</p> <p>1 1/2 DIA. HOLE</p> <p>STYLE 87 — BOX MTD. STYLE 88 — DESP. INTCH. MTD.</p>
<p>STYLE 89</p> <p>C'SK FOR 6-32x1/2 OVAL HD SCREW 2 PLACES</p> <p>1 9/16 DIA. HOLE</p> <p>STYLE 90 — BOX MTD.</p>	<p>STYLE 91</p> <p>C'SK FOR 6-32x1/2 OVAL HD SCREW 2 PLACES</p> <p>1 19/32 DIA. HOLE</p> <p>POWER OUTLET #720 Standard Plate page S-13</p>	<p>STYLE 92</p> <p>C'SK FOR 6-32x1/2 OVAL HD SCREW 2 PLACES</p> <p>1 19/32 DIA. HOLE</p> <p>STYLE 93 — DESP. INTCH. MTD.</p>	<p>STYLE 94</p> <p>C'SK FOR 6-32x1/2 OVAL HD SCREW 2 PLACES</p> <p>1 1/8 DIA. HOLE</p> <p>STYLE 95 — BOX MTD. STYLE 96 — DESP. INTCH. MTD.</p>
<p>STYLE 97</p> <p>C'SK FOR 6-32x1/2 OVAL HD SCREW 2 PLACES</p> <p>2 DIA. HOLE</p>	<p>STYLE 98</p> <p>C'SK FOR 6-32x1/2 OVAL HD SCREW 2 PLACES</p> <p>2 3/8 DIA. HOLE</p> <p>POWER OUTLET #723 Standard Plate page S-13</p>	<p>STYLE 99</p> <p>C'SK FOR 6-32x1/2 OVAL HD SCREW 2 PLACES</p> <p>2 3/8 DIA. HOLE</p>	<p>STYLE 100</p> <p>C'SK FOR 6-32x1/2 OVAL HD SCREW 4 PLACES</p> <p>3/8 DIA. HOLE</p> <p>with 2 # 340 Yokes STYLE 101 — BOX MTD.</p>

All wall plate dimensions shown above are in inches.

WALL PLATES

Style Selector Guide Custom Metal Wall Plates

<p>STYLE 102</p> <p>15 DIA HOLE C'SK FOR 6-32x1/2 OVAL HD SCREW 4 PLACES</p> <p>STYLE 103 — BOX MTD.</p>	<p>STYLE 104</p> <p>1 13/64 DIA HOLE C'SK FOR 6-32x1/2 OVAL HD SCREW 4 PLACES</p> <p>STYLE 105 — BOX MTD.</p>	<p>STYLE 106</p> <p>1 13/64 DIA HOLE C'SK FOR 6-32x1/2 OVAL HD SCREW 4 PLACES</p> <p>STYLE 107 — BOX MTD.</p>	<p>STYLE 110</p> <p>2 1/8 DIA HOLE C'SK FOR 6-32x1/2 OVAL HD SCREW 4 PLACES</p>
<p>STYLE 112</p> <p>C'SK FOR 6-32x1/2 OVAL HD SCREW 2 PLACES 17 DIA HOLE 3 PLACES</p> <p>STYLE 113 — BOX MTD. STYLE 114 — DESP. INTCH. MTD.</p>	<p>STYLE 115</p> <p>15 DIA HOLE 32 2 PLACES C'SK FOR 6-32x1/2 OVAL HD SCREW 2 PLACES 3 9/32 DIA</p>	<p>STYLE 116</p> <p>400 DIA HOLE 3 PLACES #43 (.089) DRILL 3 PLACES C'SK FOR 6-32x1/2 OVAL HD SCREW 2 PLACES</p> <p>STYLE 117 — BOX MTD. STYLE 118 — DESP. INTCH. MTD.</p>	<p>STYLE 119</p> <p>1" DIA HOLE 2 PLACES C'SK FOR 6-32x1/2 OVAL HD SCREW 2 PLACES</p>
<p>STYLE 121</p> <p>C'SK FOR 6-32x1/2 OVAL HD SCREW 2 PLACES 9 DIA HOLE 64 2 PLACES 1.228 DIA</p>	<p>STYLE 122</p> <p>C'SK FOR 6-32x1/2 OVAL HD SCREW 1 PLACE 13 DIA HOLE 1 13/32 DIA HOLE</p>	<p>STYLE 123</p> <p>9 DIA HOLE 64 2 PLACES C'SK FOR 6-32x1/2 OVAL HD SCREW 2 PLACES</p> <p>with #340 Yoke</p>	<p>STYLE 124</p> <p>5 DIA HOLE 32 2 PLACES C'SK FOR 6-32x1/2 OVAL HD SCREW 2 PLACES .675 DIA HOLE</p> <p>STYLE 125 — 2 HOLES STYLE 126 — 3 HOLES</p>
<p>STYLE 131</p> <p>C'SK FOR 6-32x1/2 OVAL HD SCREW 2 PLACES</p>	<p>STYLE 132</p> <p>C'SK FOR 6-32x1/2 OVAL HD SCREW 2 PLACES</p>	<p>STYLE 134</p> <p>2 13/32 DIA C'SK FOR 6-32x1/2 OVAL HD SCREW 4 PLACES</p> <p>POWER OUTLET #701 Standard Plate page S-14</p>	<p>STYLE 135</p> <p>C'SK FOR 6-32x1/2 OVAL HD SCREW 2 PLACES 1 1/2 DIA 125 OPENING</p> <p>STYLE 135A. — DESP. INTCH. MTD. #771 Standard Plate page S-21</p>

All wall plate dimensions shown above are in inches.

WALL PLATES

Style Selector Guide Custom Metal Wall Plates

<p>STYLE 136</p> <p>RAZOR BLADES with #340 Yoke</p>	<p>STYLE 137</p> <p>RAZOR BLADES, BOX MTD. STYLE 137B — HORIZONTAL RAZOR BLADE, BOX MTD.</p>	<p>STYLE 138</p> <p>STYLE 139 — BOX MTD. STYLE 140 — DESP. INTCH. MTD.</p>	<p>STYLE 141</p>
<p>STYLE 142</p>	<p>STYLE 143</p>	<p>STYLE 144</p> <p>STYLE 145 — 3 OPENINGS STYLE 146 — 4 OPENINGS STYLE 147 — MASTER CONTROL</p>	<p>STYLE 149</p>
<p>STYLE 150</p> <p>DESP. INTCH. MTD.</p>	<p>STYLE 152</p> <p>TELEPHONE OUTLET CENTERED 2 GANG, with #340 Yoke STYLE 151 — BOX MTD. #741, 742 Standard Plate page S-34</p>	<p>STYLE 155</p> <p>POWER OUTLET #702 Standard Plate page S-14</p>	<p>STYLE 156</p> <p>POWER OUTLET #703 Standard Plate page S-14</p>
<p>STYLE 160</p>	<p>STYLE 162</p> <p>STYLE 176 — STRAP MTD. with #340 Yoke #743 Standard Plate page S-20</p>	<p>STYLE 163</p> <p>POWER OUTLET #721 Standard Plate page S-13</p>	<p>STYLE 165</p> <p>POWER OUTLET #724 Standard Plate page S-13</p>

All wall plate dimensions shown above are in inches.

WALL PLATES

Style Selector Guide Custom Metal Wall Plates

<p>STYLE 200</p> <p>C'SK FOR 6-32x1/2 OVAL HD. SCREW 2 PLACES</p> <p>1/16" R. TYP.</p> <p>1/8" R. TYP.</p>	<p>STYLE 206</p> <p>471 DIA.</p> <p>L.062</p> <p>.031</p> <p>C'SK FOR 6-32x1/2 OVAL HD. SCREW 2 PLACES</p> <p>with #340 Yoke STYLE 207 — BOX MTD.</p>	<p>STYLE 210</p> <p>C'SK FOR 6-32x1/2 OVAL HD. SCREW 2 PLACES</p> <p>140 DIA. HOLE</p> <p>1/16" R. TYP.</p>	<p>STYLE 211</p> <p>C'SK FOR 6-32x1/2 OVAL HD. SCREW</p> <p>C'SK FOR 8-32x1/2 OVAL HD. SCREW 2 PLACES</p> <p>4-S Box Mtd. Plate available in any Standard 1 Gang Opening (Style 8 Shown)</p>
<p>STYLE 213</p> <p>C'SK FOR 6-32x1/2 OVAL HD. SCREW 2 PLACES</p> <p>203</p> <p>45°</p> <p>750</p> <p>1500</p> <p>.095</p> <p>405 DIA. HOLE</p>	<p>STYLE 214</p> <p>C'SK FOR 6-32x1/2 OVAL HD. SCREW 2 PLACES</p> <p>563</p> <p>281</p> <p>470</p> <p>940</p> <p>with #340 Yoke</p>	<p>STYLE 215</p> <p>1/8" R. 2 PLACES</p> <p>C'SK FOR 6-32x5/16 OVAL HD. SCREW 2 PLACES</p> <p>STYLE 215A — 1 HOLE CENTERED</p>	<p>STYLE 216</p> <p>140 DIA. HOLE 2 PLACES</p> <p>4375</p> <p>875</p> <p>C'SK FOR 6-32x1/2 OVAL HD. SCREW 2 PLACES</p>
<p>STYLE 217</p> <p>152 DIA. HOLE 2 PLACES</p> <p>C'SK FOR 6-32x1/2 OVAL HD. SCREW 2 PLACES</p>	<p>STYLE 218</p> <p>152 DIA. TYP.</p> <p>C'SK FOR 6-32x1/2 OVAL HD. SCREW 2 PLACES</p>	<p>STYLE 219</p> <p>3/32" R. TYP.</p> <p>152 DIA. HOLE 2 PLACES</p> <p>C'SK FOR 6-32x1/2 OVAL HD. SCREW 2 PLACES</p>	<p>STYLE 220</p> <p>152 DIA. HOLE 2 PLACES</p> <p>C'SK FOR 6-32x1/2 OVAL HD. SCREW 2 PLACES</p>
<p>STYLE 221</p> <p>152 DIA. TYP.</p> <p>C'SK FOR 6-32x1/2 OVAL HD. SCREW 2 PLACES</p>	<p>STYLE 222</p> <p>152 DIA. HOLE</p> <p>C'SK FOR 6-32x1/2 OVAL HD. SCREW 2 PLACES</p>	<p>STYLE 223</p> <p>152 DIA. HOLE 2 PLACES</p> <p>C'SK FOR 6-32x1/2 OVAL HD. SCREW 2 PLACES</p>	<p>STYLE 224</p> <p>C'SK FOR 6-32x1/2 OVAL HD. SCREW 2 PLACES</p> <p>152 DIA. HOLE 4 PLACES</p>

All wall plate dimensions shown above are in inches.

WALL PLATES

Style Selector Guide Custom Metal Wall Plates

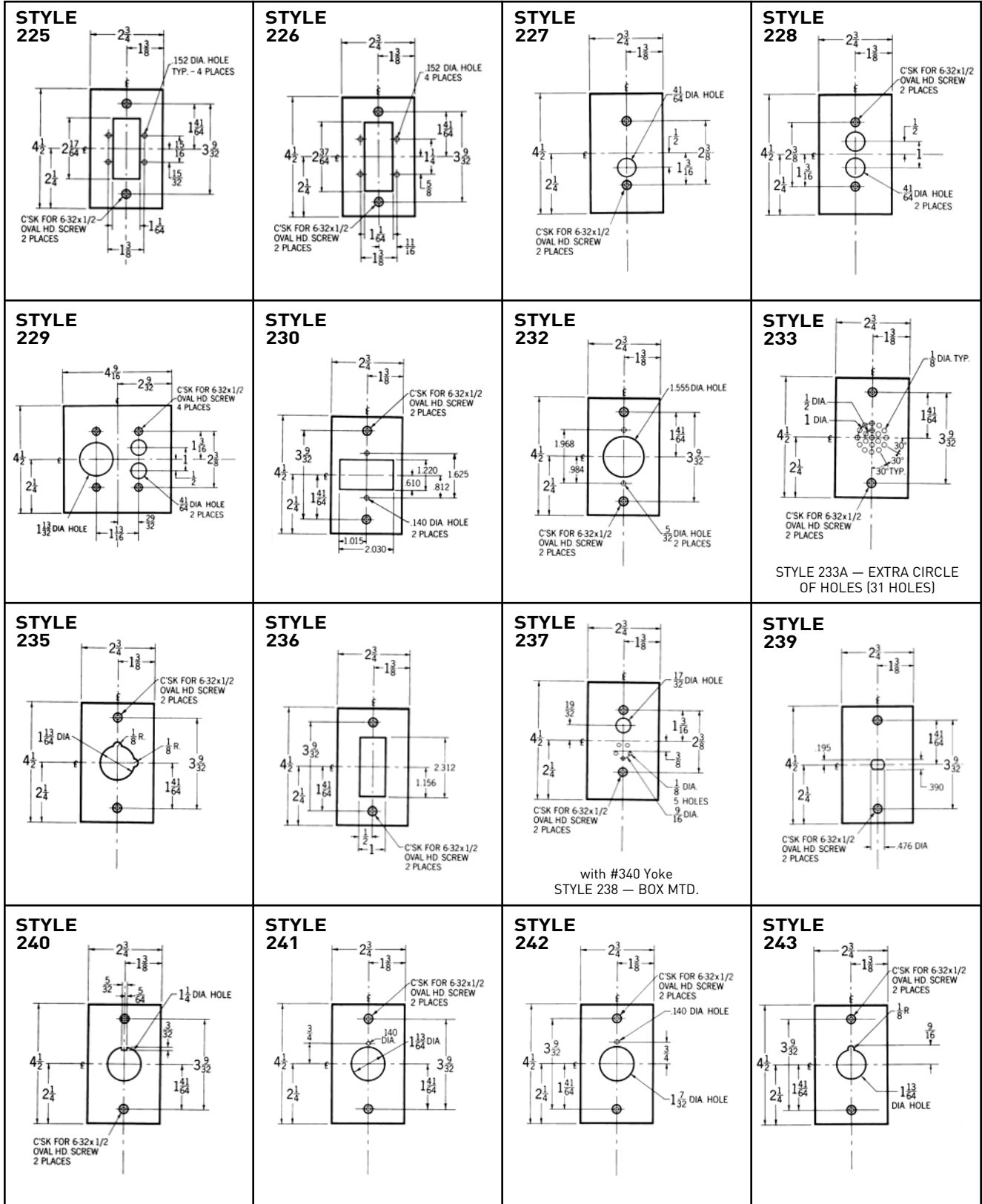

All wall plate dimensions shown above are in inches.

WALL PLATES

Style Selector Guide Custom Metal Wall Plates

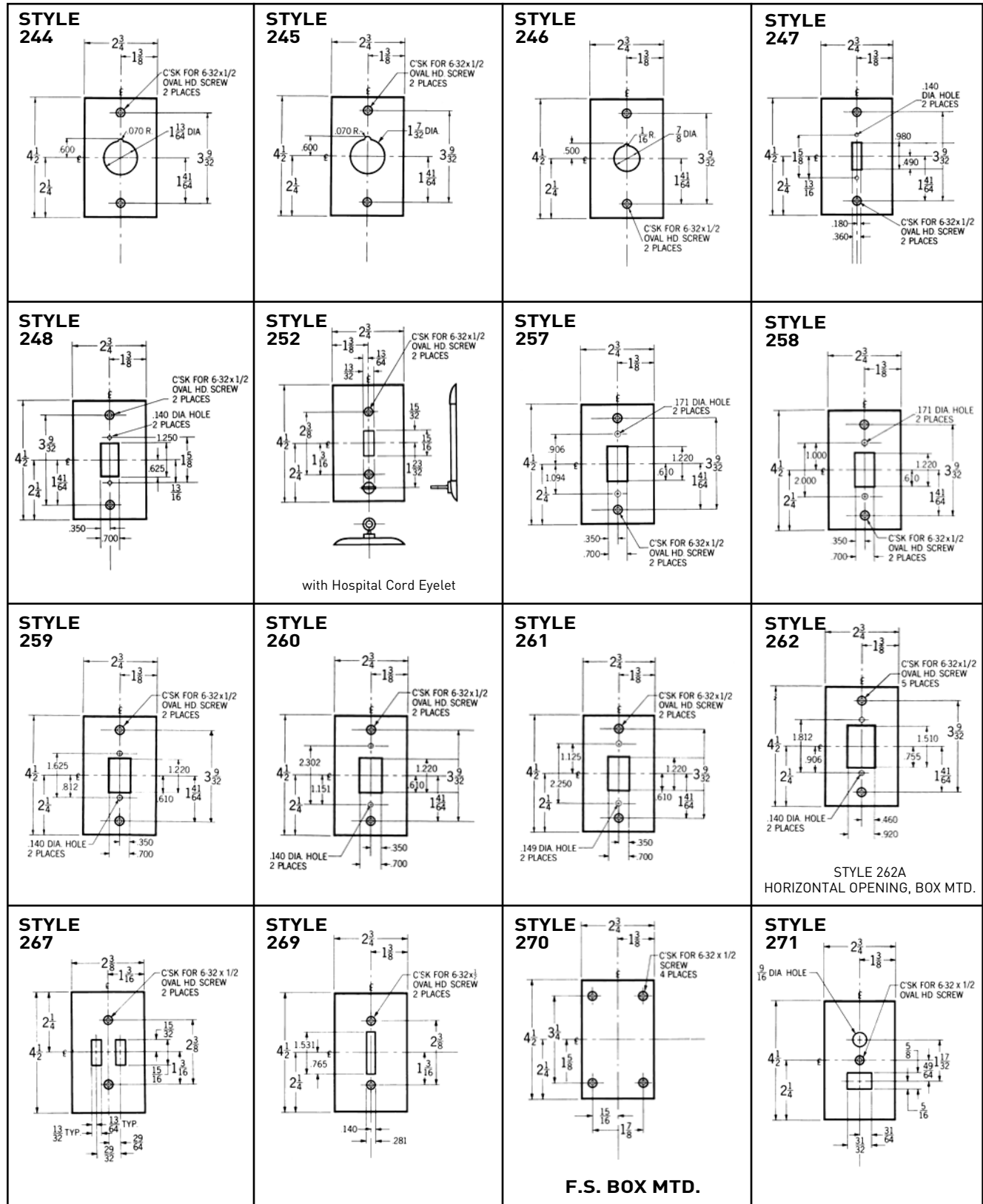

All wall plate dimensions shown above are in inches.

WALL PLATES

Style Selector Guide Custom Metal Wall Plates

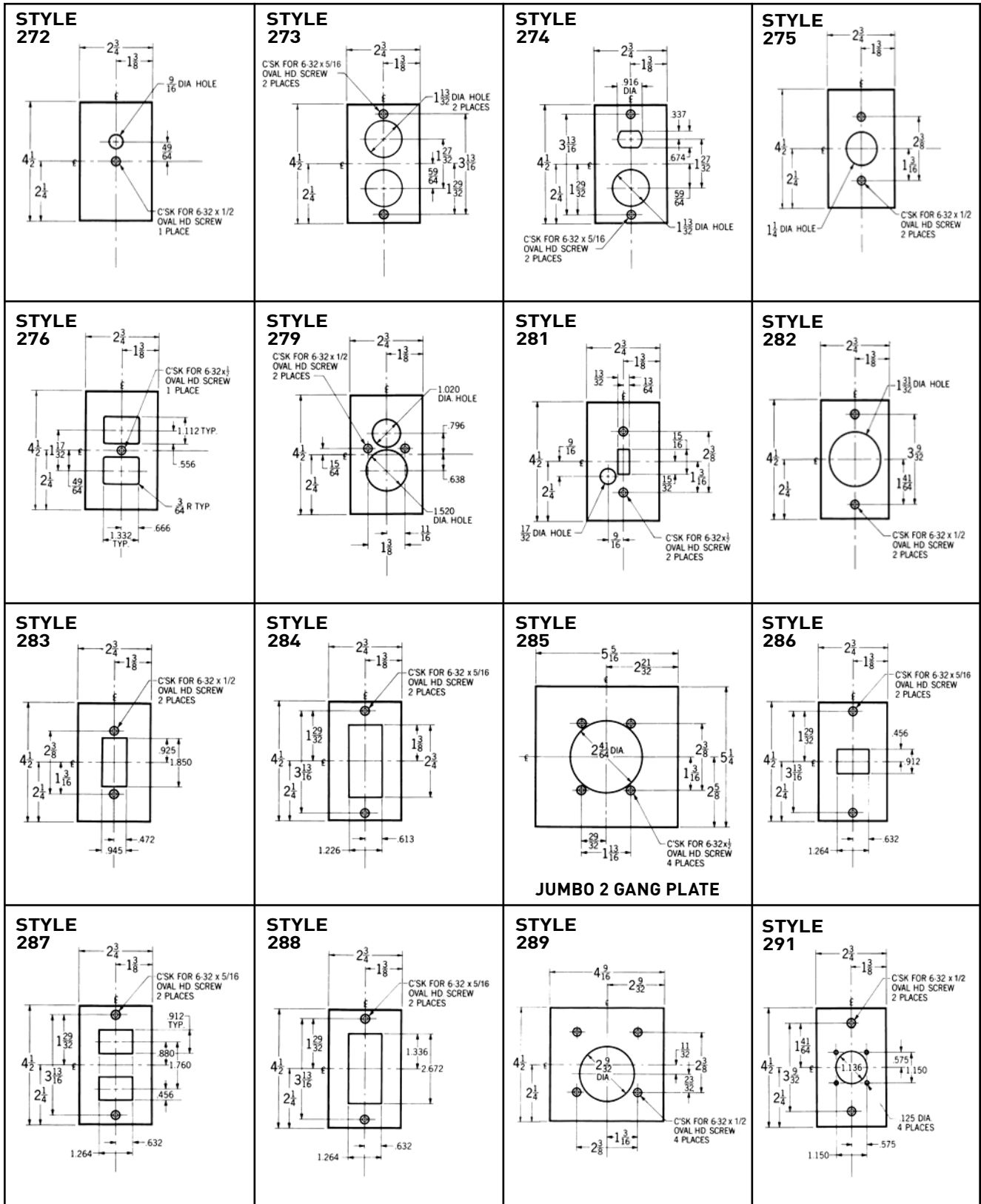

All wall plate dimensions shown above are in inches.

WALL PLATES

Style Selector Guide Custom Metal Wall Plates

<p>STYLE 292</p> <p>C'SK FOR 6-32 x 1/2 OVAL HD SCREW 2 PLACES</p>	<p>STYLE 293</p> <p>C'SK FOR #6-32 x 1/2 OVAL HD SCREW 4 PLACES</p> <p>POWER OUTLET for 30, 50, 60A. Receptacle #716 Standard Plate page S-14</p>	<p>STYLE 295</p> <p>C'SK FOR #6-32 x 1/2 OVAL HEAD SCREW 2 PLACES</p> <p>FOR RS-232 COMPUTER JACK #791 Standard Plate page S-34</p>	<p>STYLE 295A</p> <p>C'SK FOR 6-32 x 1/2 OVAL HEAD SCREW 2 PLACES</p> <p>FOR RS-232 COMPUTER JACKS #792 Standard Plate page S-34</p>
<p>STYLE 296</p> <p>C'SK FOR #6-32 x 1/2 OVAL HEAD SCREW 2 PLACES</p>	<p>STYLE 296A</p> <p>C'SK FOR #6-32 x 1/2 OVAL HEAD SCREW 2 PLACES</p>	<p>STYLE 297</p> <p>C'SK FOR 6-32 x 1/2 LONG OVAL HD. SCREW 2 PLACES</p>	<p>STYLE 298</p> <p>C'SK FOR 6-32 x 1/2 OVAL HEAD SCREW 2 PLACES</p>
<p>STYLE 299</p> <p>C'SK FOR 6-32 x 1/2 OVAL HEAD SCREW 2 PLACES</p>	<p>STYLE 300</p> <p>C'SK FOR 6-32 x 1/2 OVAL HEAD SCREW 4 PLACES</p>	<p>STYLE 301</p> <p>C'SK FOR 6-32 x 1/2 OVAL HEAD SCREW 4 PLACES</p>	<p>STYLE 302</p> <p>C'SK FOR 6-32 x 1/2 OVAL HEAD SCREW 2 PLACES</p> <p>SS-717 for PS20AC1KL Switch</p>
<p>STYLE 303</p> <p>C'SK FOR 6-32 x 1/2 OVAL HEAD SCREW 2 PLACES</p>	<p>STYLE 305</p> <p>C'SK FOR 6-32 x 1/2 OVAL HEAD SCREW 2 PLACES</p>	<p>STYLE 306</p> <p>C'SK FOR 6-32 x 1/2 OVAL HEAD SCREW 2 PLACES</p>	<p>STYLE 307</p> <p>C'SK FOR 6-32 x 1/2 OVAL HEAD SCREW 2 PLACES</p>

All wall plate dimensions shown above are in inches.

WALL PLATES

Style Selector Guide Custom Metal Wall Plates

<p>STYLE 308</p> <p>TELEPHONE JACK</p>	<p>STYLE 309</p> <p>TELEPHONE JACK</p>	<p>STYLE 310</p> <p>AMP ELECTRONIC CONNECTOR</p>	<p>STYLE 311</p> <p>COAXIAL ELECTRONIC CONNECTOR</p>
<p>STYLE 312</p> <p>COAXIAL ELECTRONIC CONNECTOR</p>	<p>STYLE 313</p> <p>COAXIAL ELECTRONIC CONNECTOR</p>	<p>STYLE 314</p> <p>LAN PORT</p>	<p>STYLE 315</p> <p>COAXIAL ELECTRONIC CONNECTOR</p>
<p>STYLE 315A</p> <p>COAXIAL ELECTRONIC CONNECTOR</p>	<p>STYLE 315B</p> <p>COAXIAL ELECTRONIC CONNECTOR</p>		

All wall plate dimensions shown above are in inches.

DEVICES & WALL PLATES

Color Selection Chart

Devices & Plastic Wall Plate Colors

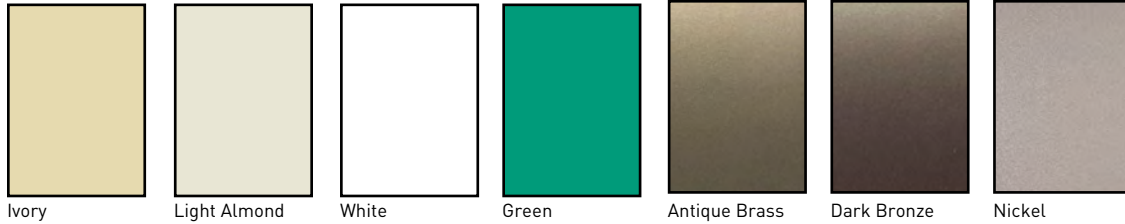

Ivory Light Almond White Green Antique Brass Dark Bronze Nickel

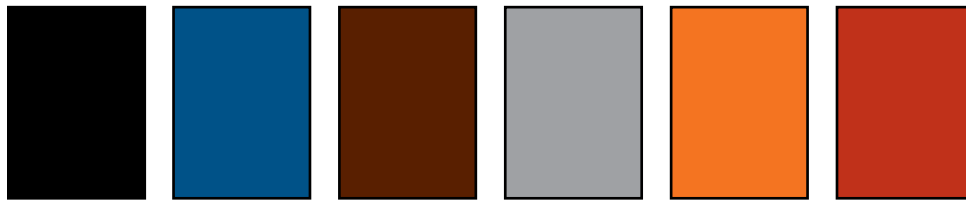

Black Blue Brown Gray Orange Red

See specific device and wall plate catalog charts for particular color availabilities.

Metal Wall Plates

Metal Finish



Aluminum Polished Brass Stainless Steel Brushed Bronze Chrome

Custom Metal Wall Plates Paint Finish Colors

Paint Color

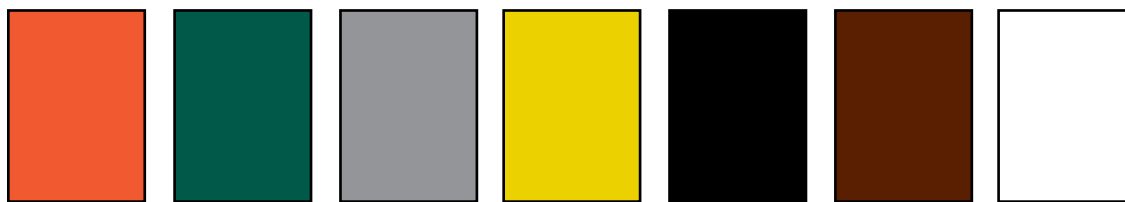

Orange Green Gray Yellow Glossy Black Brown White

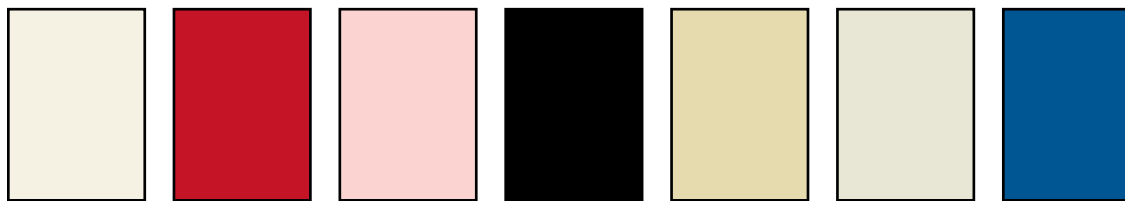

Primer Red Pink Flat Black Ivory Light Almond Blue

To order custom metal wall plates, see Pages S-40 – S-42.
For additional colors consult factory.

ELECTRICAL ACCESSORIES



Looking for the classic porcelain lampholder? A hard-to-find household adapter? Or a wide range of replacement appliance switches? You'll find them in our accessory line — along with quality materials, durability, and time-tested designs.

Appliance Switches	T-2
Fluorescent Lampholders	T-3
Incandescent Lampholders	T-4
Household Devices	T-6
Fluorescent Starters & Wall Plate Inserts	T-10
Special Purpose Devices – Despard®	T-11
Low-Voltage Switching Components	T-13
Network Wiring Connectivity	T-16
Keystone Products, Wall Plates & Frames	T-16
Activate™ Products	T-17
Frames & Wall Plates	T-18
Patch Panels, 66 Block & Patch Cords	T-19

Featured Products



**MEDIUM BASE
LAMP HOLDERS**

T-4

ELECTRICAL ACCESSORIES

Appliance Switches

APPLIANCE SWITCHES								
	CATALOG NUMBER	RATING		DESCRIPTION	COLOR	UL	CSA	cULus
	423	6A	125V	In-line cord switch, light-duty.	Brown	•	•	
	410WCC25	3A	250V			White		
	5406BK	6A	125V	Heavy-duty, feed-thru cord switch, single pole, ON-OFF sequence, markings near toggle.	Black	•	•	
	5406BKBPCC5				White			
	5406BKCC10							
	5406W							
	5406WBPCC5							
5406WCC10								
	575	3A	250V	Push button canopy switch, single pole, Bakelite plunger, ON-OFF sequence, RU Listed.	Brown	•		
		1A	250V					
	653	6A	125VT	Rotary, single pole, two circuit, four position, heavy-duty, black, blue, red leads, 1st ON, 2nd ON, both ON, OFF sequence. RU Listed.		•		
		3A	250V					
	738	8A	125V	Toggle, single throw, ON-OFF sequence, 2 black leads. (18 AWG) 6.5" long, RU Listed.			•	
	168950	3A	125V-L	Pull chain, two circuit, four position, 1st ON, 2nd ON, both ON, OFF sequence, RU Listed.		•	•	
		6A	125V					
		3A	250V					
		1/4 HP @	125/120V					
	220	6A	125V	Heavy-duty single pole canopy pull switch. 2 black leads (18 AWG) 6.5" long, RU Listed.		•	•	
		3A	250V					



ELECTRICAL ACCESSORIES

Fluorescent Lampholders

FLUORESCENT LAMP HOLDERS							
Image	CATALOG NUMBER	RATING		DESCRIPTION	COLOR	UL	CSA
		660W	600V				
	3901W	660W	600V	Medium bi-pin, screw terminals.	White	•	•
	464	660W	600V	Pedestal type, recessed, contact, plunger, with floor terminal screw cover (for 800 & 1500MA T-12 lamps).	White	•	•
	465	660W	600V	Pedestal type, recessed, fixed, quick wire terminals (for 800 & 1500MA T-12 lamps).	White	•	•
	466	660W	1000V	Pedestal type, recessed, plunger, quick wire terminals (for all sizes of lamps T-12, T-8, and T-6).	White	•	
	467	660W	600V	Pedestal type, recessed, fixed, quick wire terminals (for all sizes of lamps T-12, T-8, and T-6).	White	•	
	2536	660W	1000V	Slimline, for single pin lamps, shallow base, slide plunger, push in terminal.	White	•	•
	2537	660W	600V	Slimline, for single pin lamps, shallow base, slide fixed, 2 push in terminals.	White	•	•
	13053UN	660W	660V	Slide-on, short, for medium bi-pin lamps with captive nut, 4 quick wire terminals.	White	•	
	13057UN	660W	600V	Slide-on, for medium bi-pin with captive 4 quick wire terminals.	White	•	•



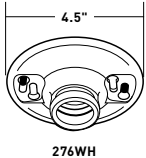

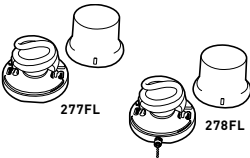
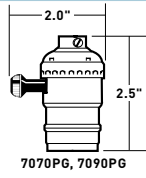
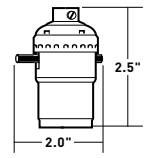
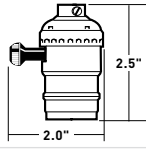
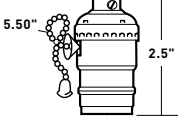



ELECTRICAL ACCESSORIES

Incandescent Lampholders

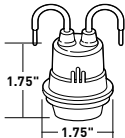
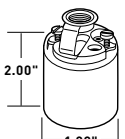
MEDIUM BASE LAMP HOLDERS									
	CATALOG NUMBER	RATING		DESCRIPTION	COLOR	cULus	UL	CSA	
 <p>272WH</p>	272	660W	250V	Medium base, porcelain, one piece keyless, 2 terminals with tri-drive screws, fits 3-1/4" and 4" boxes, with cage neck.	White		•	•	
	272WH6	660W	250V	Same with 6" leads.	White		•	•	
	274	660W	250V	Medium base, porcelain, one piece keyless, 4 terminals with tri-drive screws, fits 3-1/4" and 4" boxes.	White		•	•	
	276WH	660W	250V	Medium base, phenolic, one-piece keyless, 4 terminals with tri-drive screws, fits 3-1/4" and 4" boxes, with cage neck.	White		•	•	
 <p>280WH</p>	276WH6	660W	250V	Same with 6" leads.	White		•	•	
	282	250W	250V	Medium base, porcelain, pullchain, 2 terminals with tri-drive screws, fits 3-1/4" and 4" boxes, with cage neck.	White		•	•	
	284	250W	250V	Medium base, porcelain, pullchain, 4 terminals with tri-drive screws, fits 3-1/4" and 4" boxes, with cage neck.	White		•	•	
	280WH	250W	250V	Medium base, phenolic, pullchain, 4 terminals with tri-drive screws, fits 3-1/4" and 4" boxes, with cage neck.	White		•	•	
 <p>288</p>	280WH6	250W	250V	Same with 6" leads.	White		•	•	
	29816C2	250W	250V	Medium base, porcelain, pullchain, 2 terminals with tri-drive screws, 6" leads, fits 3-1/4" and 4" boxes with cage neck.	White		•	•	
	288	250W	125V	Medium base, porcelain, pullchain, 2 terminals with tri-drive screws, 15A 125V grounding receptacle, fits 3-1/4" and 4" boxes, with cage neck.	White		•	•	
CFL LAMP HOLDERS									
 <p>277FL 278FL</p>	277FL	13W	120V, 60Hz	Compact Fluorescent Lampholder, includes GU24 lamp, Energy Star qualified	White	•			
	278FL	13W	120V, 60Hz	Compact Fluorescent Lampholder with pull chain, includes GU24 lamp, Energy Star qualified	White	•			
METAL SHELL LAMP HOLDERS									
 <p>7070PG, 7090PG</p>	7070PG	250W	250V	Medium base, metal shell, removable turn knob, electrolier, 2 lamp controls, 3 terminals, 1st ON, 2nd ON, both ON, OFF sequence.			•	•	
	7090PG	250W	250V	Medium base, metal shell, removable turn knob, electrolier, 3-way LO-MED-HIGH.			•		
	7090M			Interior only for 7090-PG.			•		
	7090MH			Interior only with hickey for 7090-PG.			•		
 <p>6098PG</p>	6098PG	660W	250V	Medium base, push through, metal shell, electrolier, single circuit.			•	•	
	1008316	250W	250V	Medium base, metal shell, removable turn knob, single circuit, electrolier, 1/8" IPS tapped bushing with set screw.			•		
 <p>10083M</p>	10083M			Interior only for 10083-16.			•		
	19980PG	660W	250V	Medium base, metal shell, pull chain, electrolier, single circuit, 1/8" IPS bushing with set screw.			•	•	
 <p>8002M</p>	8002M			Interior only for 19980.			•		

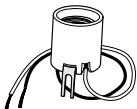
ELECTRICAL ACCESSORIES

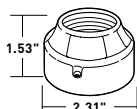
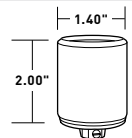
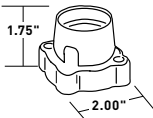





Incandescent Lampholders

METAL SHELL LAMP HOLDERS								
	CATALOG NUMBER	RATING		DESCRIPTION	COLOR	UL	CSA	cULus
	975ABDCC10	660W	250V	Medium base, metal shell, keyless.	Brass	•	•	
MEDIUM BASE LAMP HOLDERS								
	8101	660W	250V	Medium base, porcelain, keyless, single circuit, 2 piece ring with leads. 1-3/8" to 1-1/2" hole.	White	•		
	201	660W	600V	Medium base, rubber, keyless, for temporary lighting, 2 wire leads 6" long.	Black	•		•
	31528	660W	250V	Medium base, porcelain, screw terminals, keyless, single circuit, fixture pan with 1/8" IPS hickey.	White	•	•	
	3352F	660W	250V	Medium base, porcelain, keyless, screw terminals, short base.	White	•	•	
	8052CC10	660W	250V	Medium base, porcelain, bracket mount.	White	•	•	
	9814	250W	250V	Medium base, porcelain, 2-piece pull chain, ring type, screw terminals, gasket furnished.	White			
	9880	660W	250V	Medium base, porcelain, surface mount type, 2-piece.	White	•	•	
	10045	660W	250V	Medium base, porcelain, keyless, single circuit with screw terminals, aluminum screw shell with set.	White	•	•	
	10085	660W	250V	Medium base, porcelain, keyless, single circuit with 2-18 AWG leads 6" long.	White	•	•	
	19062	660W	250V	Medium base, porcelain, pony cleat type, terminal screws.	White	•	•	
	S752WCC10	660W	250V	Medium base, cleat sockets, front wire.	White			•
	61	660W	125V	Medium base, outlet to lampholder, 2 Pole, 2 Wire.	Brown			

All devices listed on this page conform to NEMA WD-1 and WD-6.

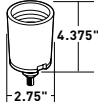
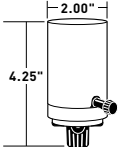
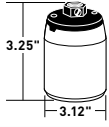
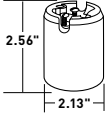
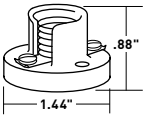
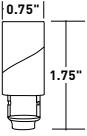
ELECTRICAL ACCESSORIES

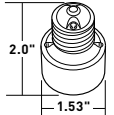
Incandescent Lampholders & Household Devices

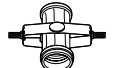
MEDIUM BASE LAMPHOLDERS							
	CATALOG NUMBER	RATING		DESCRIPTION	COLOR	UL	CSA
	4017CC10	660W	250V	Medium base, single-to-twin.	Black	•	•
	4063CC10	250W	250V	Medium base, turn knob, 3 way.	Black	•	•
	4155	660W	250V	Candle socket, bottom turn knob, one piece, phenolic body.	Black	•	
MOGUL BASE LAMPHOLDERS							
	8601	750W	250V	Mogul base, porcelain, removable turn knob, 2 circuits, hickey tapped 1/4" IPS x 7/8" high.	White	•	
	8678	1500W	600V	Mogul base, porcelain, keyless, single circuit, 1/4" IPS 13/16" hexagon x 9/16" high with screw set.	White	•	•
	8694	1500W	600V	Mogul base, porcelain, screw terminals, keyless, single pole with bushings, 4KV pulse rated.	White	•	
PONY CLEAT TYPE LAMPHOLDERS							
	10020	75W	125V	Pony cleat type, plastic, miniature base.	White		
	10028	75W	125V	Pony cleat type, plastic, candelabra base.	White		
CANDELABRA BOX LAMPHOLDERS							
	10027	75W	125V	Candelabra base, keyless, screw terminals, solid hickey, overall height 1-1/2", paperboard sleeve.		•	
TEMPORARY LIGHTING DEVICES							
	43308	660W	250V	Medium base, phenolic, pin type hook supplied, for temporary use.	Black	•	
SOCKET EXTENSIONS/CLUSTERS							
	2005	660W	250V	Socket extensions, medium-to-medium, one piece porcelain, 1.25" extension.	White	•	•
	2006	660W	250V	Socket extensions, medium-to-medium, one piece phenolic, 1.1875" extension.	White	•	•
	341DU4	660W	250V	Medium base, multi-lampholder cluster, 3 lights 1/8" IPS male (top & bottom), 2 wire leads (18 AWG) 6.5" long.	Black		
	4015D4F	660W	250V	Medium base, multi-lampholder cluster, 2 lights 1/8" IPS male (top & bottom).	Black		







ELECTRICAL ACCESSORIES

Household Devices

PLUGS & CONNECTORS		CATALOG NUMBER	RATING		DESCRIPTION	COLOR	UL	CSA
		101	15A	125V	Clamptite plug, light-duty, 2 Pole, 2 Wire.	Black	•	
		84BKCC20	15A	125V	Angle plug, light-duty, 2 Pole, 2 Wire.	Black	•	•
		111MC	15A	125V	Rubber plug, with vinyl cord clamp, 2 Pole, 2 Wire.	Black	•	
		111GMC	15A	125V	Rubber plug, with vinyl cord clamp inner assembly, 2 Pole, 3 Wire, (mates with 114GMC).	Black	•	
		114GMC	15A	125V	Rubber connector, with vinyl cord clamp, 2 Pole, 3 Wire, (mates with 111GMC).	Black	•	
		123P	10A 3A	125V 125V	Easy wire plug, 10A 125V use with 18-2 SPT-1 Cord, 3A 125V use with 20-2XT Cord, non-polarized.	Brown	•	
		123PW				White	•	
		48643	15A	125V	Plug, vinyl, short flat, 2 Pole, 2 Wire.	Brown	•	
		83CC4	30A	125V	Angle travel trailer plug, 2 Pole, 3 Wire.	Black	•	•
		SA155BKCC10	15A	125V	Straight blade connector, polarized, 2 Pole, 2 Wire.	Black	•	•
		SA155CC10				Brown	•	•
		SA155WCC10				White	•	•
		SA440BKCC10	15A	125V	Straight blade plug, 2 Pole, 2 Wire.	Black	•	•
		SA440CC10				Brown	•	•
		SA440WCC10				White	•	•
		SA540BKCC10	15A	125V	Straight blade plug, polarized, 2 Pole, 2 Wire.	Black	•	•
		SA540CC10				Brown	•	•
		SA540WCC10				White	•	•
		SA840BKCC10	15A	125V	Straight blade plug, with cord clip, 2 Pole, 2 Wire.	Black	•	•
		SA840CC10				Brown	•	•
		SA840WCC10				White	•	•
		SA399BKCC10	15A	125V	Straight blade plug, 2 Pole, 3 Wire.	Black	•	•
		SA399GRYCC10				Gray	•	•
		SA399OCC10				Orange	•	•
		SA399WCC10				White	•	•
		SA993BKCC10	15A	125V	Straight blade connector, 2 Pole, 3 Wire.	Black	•	•
		SA993GRYCC10				Gray	•	•
		SA993OCC10				Orange	•	•
		SA993WCC10				White	•	•

ELECTRICAL ACCESSORIES

Household Devices

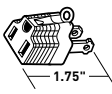
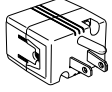
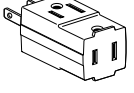
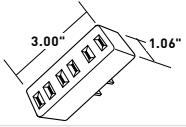
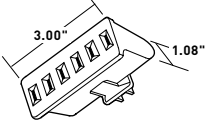
QUICK CLAMP PLUGS & CONNECTORS								
 123PQC  123C3W	CATALOG NUMBER	RATING		DESCRIPTION	COLOR	UL	CSA	
	123PQC	10A with 18AWG SPT-1 & 2 Cord, 13A with 16AWG SPT-1 Cord			2 wire Quick Clamp plug	Brown	•	
	123PQCW					White	•	
	123C3W					White	•	
ADAPTERS								
	125	15A 660W	125V	Lampholder to outlet, medium base.	White	•		
	1406	250W	125V	Medium base lampholder/outlet adapter, pull chain lampholder with 2 outlets, 2 Pole, 2 Wire.	Black	•		
	128	660W	250V	Single lampholder-to-twin lampholder, medium base.	Brown	•		
	8681	660W	250V	Mogul to medium socket adapter, 1 piece. 1.66" Dia. x 2.0" Deep	White	•	•	
	1264	15, 20A	125V	Travel trailer adapter, 2 Pole, 3 Wire.				
 1.75"	210G	15A	125V	Adapter, parallel blades, molded rubber, polarized, 3 Wire grounding.	Gray	•		
	1482ICC10	15A	125V	Cube tap, single to triple outlet, 2 Pole, 3 Wire.	Ivory	•	•	
	68	15A	125V	Cube tap, phenolic, single to triple, 2 Pole, 2 Wire.	Brown			
	68I				Ivory			
 3.00" 1.06"	63	15A	125V	Plug-in adapter, single to triple, polarized, 2 Pole, 2 Wire.	Brown	•	•	
 3.00" 1.08"	69W	15A	125V	Plug-in adapter, single to triple, swivel, polarized, 2 Pole, 2 Wire.	White	•	•	

ELECTRICAL ACCESSORIES

Household Devices

ADAPTERS							
	CATALOG NUMBER	RATING		DESCRIPTION	COLOR	UL	CSA
	697	15A	125V	Plug-in outlet adapter, single to triple, 2 Pole, 3 Wire.	Brown	•	
	697I				Ivory	•	
	697RI	15A	125V	Plug-in outlet adapter, single to triple, rubber, 2 Pole, 3 Wire.	Ivory	•	
	697W	15A	125V	Plug-in outlet adapter, single to triple, 2 Pole, 3 Wire.	White	•	
	699CC25	15A	120V	Plug-in outlet adapter, single to triple, 2 Pole, 3 Wire.	Brown	•	•
	699GRCC25				Green	•	•
	226PAI	15A	125V	Plug-in adapter, two to six, polarized, 2 Pole, 3 Wire.	Ivory	•	•
	226PAW				White	•	•
MISCELLANEOUS DEVICES							
	941904	150W	120V	Dawn to dusk dimmer, automatic light sensor fits into standard lamp socket. Indoor or outdoor use.	Gray	•	•
	13741	15A	125V	Snap-in receptacle, 3 Wire grounding outlet with 6\" leads, No. 14 AWG 105°C plastic.	Black	•	•
	746ICC10	15A	125V	Surface outlet, 2 Pole, 2 Wire.	Ivory	•	•
	779CC5	15A	120/277V	Cover-mounted switch.		•	•
	735CC10	10A 5A	125V 250V	Surface mount switch	Black		
	735ICC10				Ivory		
	5SC			Outlet safety caps.	Clear	•	

ELECTRICAL ACCESSORIES

Fluorescent Starters & Wall Plate Inserts

FLUORESCENT STARTERS				
	CATALOG NUMBER	DESCRIPTION	UL	CSA
	FS2	Glow switch starter without reset, 2 pins 14, 15 & 20W.	•	•
	FS4	Glow switch starter without reset, 2 pins 13, 30 & 40W.	•	•
	FS5	Glow switch starter without reset, 2 pins 4, 6 & 8W.	•	•
	FS25	Glow switch starter without reset, 2 pins 22W Circline 25W Std.	•	•
WALL PLATE INSERTS				
DIMENSIONS	CATALOG NUMBER	DESCRIPTION	FINISH	COLOR
	325I	Mounting strap for blank insert. Box mounted.	Polycarbonate	Ivory
	325W	Changes decorator opening to blank.	Plastic	White
	325			Brown
	325BK			Black
	325LA			Light Almond
	325GRY			Grey
	326I	Mounting strap for blank insert. Box mounted.	Painted	Ivory
	326W	Changes decorator opening to blank.	Steel	White
	326			Brown
	326LA			Light Almond
	327I	Mounting strap for dimmer insert. Box mounted.	Painted	Ivory
	327W	Change from decorator to toggle opening.	Steel	White
	327			Brown
	327LA			Light Almond
	80700I	Mounting strap for blank insert. Box mounted.	Thermoset	Ivory
	80700W	Changes toggle opening to blank.	Plastic	White
	80700LA			Light Almond

ELECTRICAL ACCESSORIES

Special Purpose Devices – Despard®

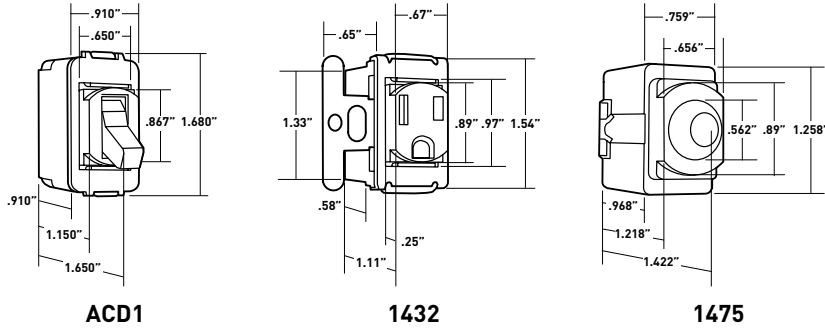

CATALOG NUMBER		COLOR	RATING		3RD PARTY COMPLIANCE
SINGLE POLE	THREE-WAY		A.	V.	UL20
TOGGLE SWITCHES SCREW TERMINALS					
ACD11	ACD31	Ivory	15	120/277	•
ACD1W	ACD3W	White	15	120/277	•
ACD1	ACD3	Brown	15	120/277	•
ACD2011	ACD2031	Ivory	20	120/277	•
ACD201	ACD203	Brown	20	120/277	•

HP CONVERSION TABLE	
15 Amp	1/2 Horsepower at 120VAC; 2 Horsepower at 240VAC
20 Amp	1 Horsepower at 120VAC; 2 Horsepower at 240VAC
30 Amp	2 Horsepower at 120VAC; 2 Horsepower at 240VAC

CATALOG NUMBER	COLOR	RATING		DESCRIPTION	3RD PARTY COMPLIANCE
		A.	V.		UL498
RECEPTACLES THREE WIRE GROUNDING					
1432	Ivory	15	125	Must be installed in end opening of strap with Ground Lead	•
1532	White	15	125		•
1332	Brown	15	125		•
1433	Ivory	15	125		•
1333	Brown	15	125		•

CATALOG NUMBER	COLOR	RATING		DESCRIPTION	3RD PARTY COMPLIANCE
		A.	V.		UL542
NEON PILOT LIGHTS					
1375	Brown	1/25	125	Flush Red Neon Pilot Light with Screw Terminals	•
1375220	Brown	1/8	220		•
1475	Ivory	1/25	125		•
1475277	Ivory	1/6	277		•
1575	White	1/25	125		•

CATALOG NUMBER	COLOR	RATING		DESCRIPTION
		A.	V.	
FLUSH PILOT LIGHTS WITH MOUNTING STRAPS				
1376	Brown	6	125	Single, for Single Vertical Opening Plate
1377	Brown	6	125	Combination, for Switch or Outlet Plate

All devices listed on this page conform to NEMA WD-1 and WD-6.

ELECTRICAL ACCESSORIES

Special Purpose Devices – Despard®

CATALOG NUMBER	DESCRIPTION	SCREW SPACING	FINISH
RECEPTACLES THREE WIRE GROUNDING			
342	Tandem mounting strap with two vertical openings. Plate screw hole spacing 4-3/8".	4-3/8"	Bright Zinc
347	Mounting strap with single vertical opening. Plate screw hole spacing 3-13/16". Box mounted.	3-13/16"	Bright Zinc
348	Mounting strap with three horizontal openings. Plate screw hole spacing 3-13/16". Box mounted.	3-13/16"	Bright Zinc
1354	Appliance Strap.	1-31/32"	

The correct style of mounting strap is furnished with each Despard wall plate, but straps may be ordered separately. Consult Page 5-35 for additional mounting straps.

Dimensions

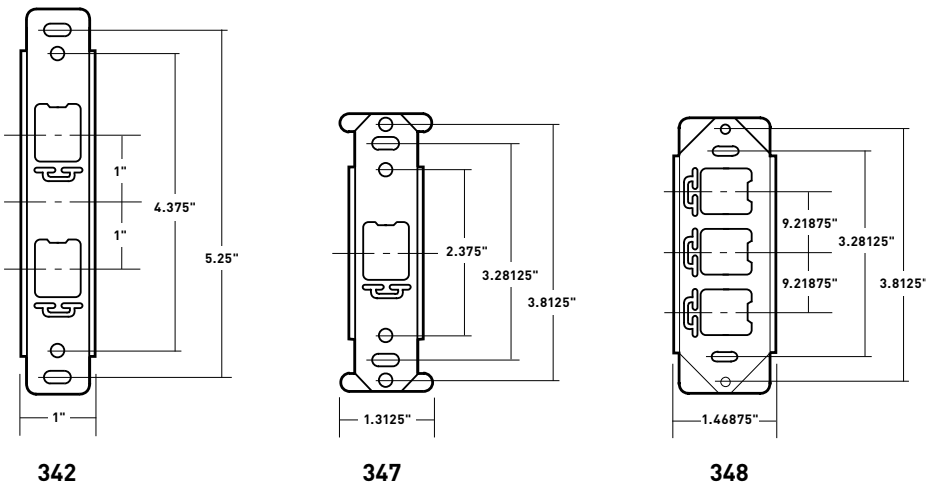

Installation & Removal

To assemble Despard devices in strap, insert tab on strap into the slot in the device; a twist of a screwdriver in the slots on the opposite side of the strap turns a slim strip of metal into the mounting slot on that side of the device to lock the device securely in place. To remove the device, reverse the procedure.

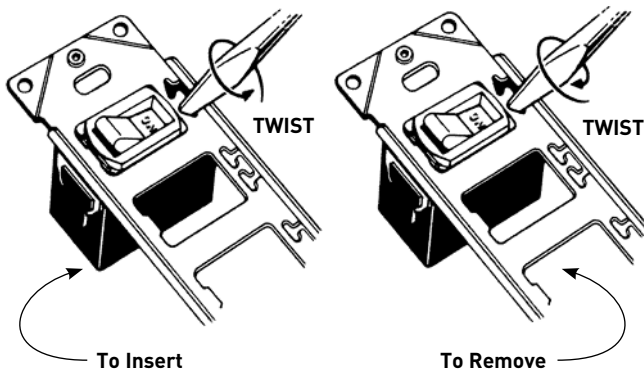

ELECTRICAL ACCESSORIES

Low-Voltage Switching Components

Features

- Mount in standard 1/2" KO through noise suppressing nylon ring.
- Maximum ambient temp: 140°F (60°C).
- Insulated flame retardant nylon shell.
- Prestripped 5-1/2" (140mm) #22 AWG leads for easy wiring.
- Split coil design energizes ON coil to close line contacts, and OFF coil to open contacts.
- Can be mounted in any position.
- Operates on momentary impulse.
- Draws .520 mA.

CATALOG NUMBER	RATING		3RD PARTY COMPLIANCE	
	A.	V.	UL Listed	CSA Listed
MAGNETIC LATCHING RELAY, 24V/24VDC CONTROL				
1070B	20	120/277V	•	•
	20	347V		

CSA listed for 347V.

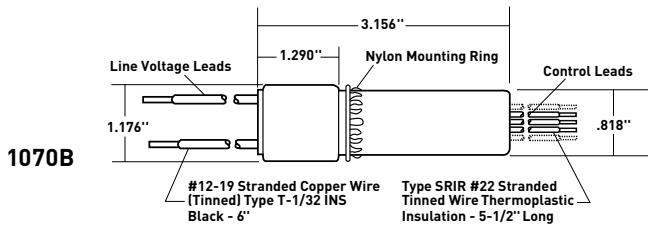

Features

- Available in Despard® interchangeable and heavy-duty toggle versions.
- Side wired screw terminals.
- Heavy-duty toggles recommended where low-voltage switches must match conventional switches.

	COLOR	RATING		DESCRIPTION
		A.	V.	
MOMENTARY CONTACT SWITCHES				
1091I	Ivory	3	24 AC/DC	Despard Interchangeable
1091W	White	3	24 AC/DC	Despard Interchangeable
1091	Brown	3	24 AC/DC	Despard Interchangeable
1091GRY	Gray	3	24 AC/DC	Despard Interchangeable
1091KGRY	Gray	3	24 AC/DC	Despard Interchangeable, Key-Locking
1050K				Key only for Despard Locking Switch
1081I	Ivory	3	24 AC/DC	Heavy-Duty Toggle
1081W	White	3	24 AC/DC	Heavy-Duty Toggle
1081	Brown	3	24 AC/DC	Heavy-Duty Toggle
1081GRY	Gray	3	24 AC/DC	Heavy-Duty Toggle
1081LA	Light Almond	3	24 AC/DC	Heavy-Duty Toggle
1081RED	Red	3	24 AC/DC	Heavy-Duty Toggle
1081KGRY	Gray	3	24 AC/DC	Heavy-Duty Key-Locking
500K				Key only for Heavy-Duty Locking Switch

Note: When installing low-voltage control wiring, wires should not be bundled or run in parallel with line voltage wires.

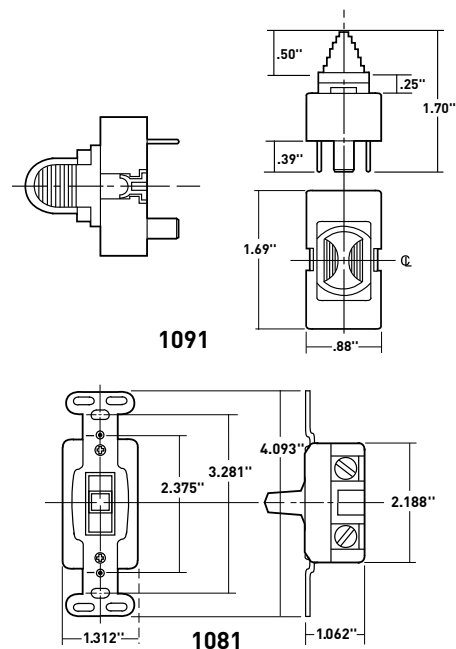

ELECTRICAL ACCESSORIES

Low-Voltage Switching Components

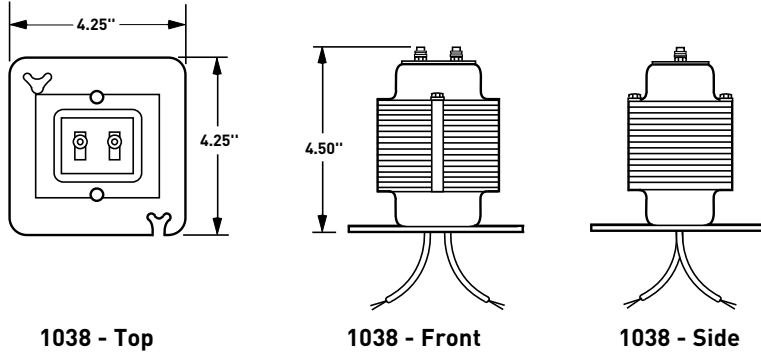

Features

- 100% HIPOT tested primary and secondary.
- Built-in overload protection.
- Base fits 4 Screw box.

CATALOG NUMBER	VA RATING	PRIMARY VOLTS	SECONDARY VOLTS	SECONDARY OUTPUT
RECEPTACLES THREE WIRE GROUNDING				
1038	75 VA	120V	24V	3.12A
1039	75 VA	277V	24V	3.12A

A 75VA transformer can drive a maximum of 7 relays simultaneously. However, the length of a wire run as well as the size of the wire itself have an effect on a transformer's output capability. The following tables will be useful in selecting the proper wire size and length of wire runs.

75VA transformer

(1038 or 1039) switch leg-length of run in feet (2 wires):

NO. OF RELAYS IN PARALLEL	#12 WIRE	#14 WIRE	#16 WIRE	#18 WIRE	#20 WIRE	#22 WIRE
1	3000'	2000'	1200'	750'	500'	300'
2	1500'	1000'	600'	375'	250'	150'
3	1000'	650'	400'	250'	160'	100'
4	750'	500'	300'	180'	125'	75'
5	600'	400'	240'	150'	100'	60'
6	500'	330'	200'	125'	80'	50'
7	420'	280'	170'	100'	70'	40'

NOTES: Relays in Parallel – Relays so wired will all be activated by any switch in the circuit.
If more than one transformer is used, the load should be divided between transformers.

ELECTRICAL ACCESSORIES – NETWORK WIRING CONNECTIVITY

Keystone Products, Wall Plates & Frames

WP3450LA

WP3481LA

WP3457W

WP3455W

KTPDL1W

**KS226W
KS426W**

Keystone Products

Enhanced Keystone product offering includes jacks and adapters that feature quick, snap-in mounting that saves installation time. A flexible modular design allows for fast, easy configuration. Use with TradeMaster® Keystone Wall Plates.

Keystone Products

CATALOG NUMBER	DESCRIPTION	AVAILABLE COLORS
WP3460_	Keystone RJ45 Category 6, T568A/B Universal Wiring	BK, BL, G, I, LA, OR, RED, W, Y
WP3450_	Keystone RJ45 Category 5e, T568A/B Universal Wiring	BK, BL, G, I, LA, OR, RED, W, Y
WP3425_	Keystone RJ25C 6P/6C Category 3, USOC Wiring	I, LA, W, BR
WP3451_	Keystone RJ45 Category 5e, Female to Female Connector	I, LA, W

Keystone Multimedia & Fiber Adapters

CATALOG NUMBER	DESCRIPTION	AVAILABLE COLORS
WP3481_	Keystone Standard F Connector	I, LA, W, BK, BR
WP3482_	Keystone Self-Terminating F Connector	I, LA, W, BK, BR
KSBNC_	Keystone BNC Connector	I, LA, W
WP3457_	Pair of Keystone Binding Posts, Red/Positive, Black/Negative	I, LA, W, BK, BR
KSSV_	Keystone S-Video, 110 Termination	I, LA, W
KSRCAB_	Keystone RCA (Black Insulator) Bulkhead	I, LA, W
KSRCAR_	Keystone RCA (Red Insulator) Bulkhead	I, LA, W
KSRCAY_	Keystone RCA (Yellow Insulator) Bulkhead	I, LA, W
WP3462_	Keystone RCA (Red Insulator) to F Connector	I, LA, W, BK, BR
KSSC_	Keystone SC Multimode, Phosphor Bronze Sleeve	I, LA, W
KSST_	Keystone ST Multimode, Phosphor Bronze Sleeve	I, LA, W
WP3455_	Keystone Blank Inserts (Includes 10 Blanks)	I, LA, W, BK, BR

Replace _ in Catalog Number with Keystone Color Code to designate color.

Color Codes for Keystone Products

BK**	BL**	G**	BR	I	LA	OR**	RED**	W	Y**
Black	Blue	Green	Brown	Ivory	Light Almond	Orange	Red	White	Yellow

**Each sold as a package of 10.

TradeMaster® Keystone Wall Plates & Decorator Frames

Virtually unbreakable TradeMaster® Keystone Wall Plates provide better coverage with an extra 3/16" width and height than standard wall plates to reduce time-consuming drywall rework. Available with label windows to help make identification easy.

WITHOUT LABEL WINDOWS	AVAILABLE COLORS	DESCRIPTION	WITH LABEL WINDOWS	AVAILABLE COLORS
WP3403_	I, LA, W, BK, BR, G, Stainless Steel	3-Port Keystone Wall Plate	KTPDL1_	I, LA, W
KTPD4_	I, LA, W, BR	4-Port Keystone Wall Plate	KTPDL4_	I, LA, W
KTPD6_	I, LA, W	6-Port Keystone Wall Plate	KTPDL6_	I, LA, W
KS226_	I, LA, W, BK, BR	2-Port Keystone Decorator Frame		
KS326_	I, LA, W, BK, BR	3-Port Keystone Decorator Frame		
KS426_	I, LA, W, BK, BR	4-Port Keystone Decorator Frame		

Replace _ in Catalog Number to designate color.

All devices listed on this page conform to NEMA WD-1 and WD-6.

ELECTRICAL ACCESSORIES – NETWORK WIRING CONNECTIVITY

Frames & Wall Plates



TPD1LA



TPD9LA

Multimedia & Decorator Frames

CATALOG NUMBER	DESCRIPTION	AVAILABLE COLORS
C5EF_	Category 5e Jack and F Connector	I, W

Each sold as a package of 10.
Replace _ in Catalog Number to designate color.

TradeMaster® Datacom Wall Plates

CATALOG NUMBER	DESCRIPTION	AVAILABLE COLORS
TPD1_	1-Port TradeMaster Datacom Wall Plate, Single Gang	GRY, I, LA, W
TPD2_	2-Port TradeMaster Datacom Wall Plate, Single Gang	GRY, I, LA, W
TPD3_	3-Port TradeMaster Datacom Wall Plate, Single Gang	GRY, I, LA, W
TPD4_	4-Port TradeMaster Datacom Wall Plate, Single Gang	GRY, I, LA, W
TPD6_	6-Port TradeMaster Datacom Wall Plate, Single Gang	GRY, I, LA, W
TPD9_	9-Port TradeMaster Datacom Wall Plate, Double Gang	GRY, I, LA, W

Replace _ in Catalog Number to designate color.

ELECTRICAL ACCESSORIES – NETWORK WIRING CONNECTIVITY

Patch Panels, 66 Block & Patch Cords

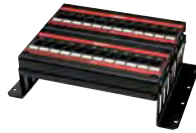
48845CC6

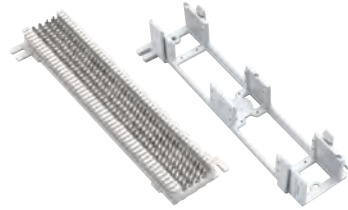
JP24845C5E

12845C5E89

PS665089V*

*Block and bracket pictured separately, product sold together as one catalog number.

Patch Panels

High-performance panels meet the TIA/EIA-568-B.2 standard for connecting hardware, including Addendum 1 for Cat 6 component performance.

Category 6

CATALOG NUMBER	DESCRIPTION	DIMENSIONS	RACK UNITS
24845CC6	24-Port T568A/B Universal Wiring	19" x 1.75"	1
48845CC6	48-Port T568A/B Universal Wiring	19" x 3.50"	2

Category 5e

CATALOG NUMBER	DESCRIPTION	DIMENSIONS	RACK UNITS
24845C5E	24-Port T568A/B Universal Wiring	19" x 1.75"	1
48845C5E	48-Port T568A/B Universal Wiring	19" x 3.50"	2

Dimensions shown are W x H.
One Rack Unit = 1.75" H.

Category 5e Modular IDC Wall-Mount Jack Panels with Stand-Off Legs

CATALOG NUMBER	DESCRIPTION	DIMENSIONS
JP12845C5E	12-Port T568A/ Universal Wiring	10.69" x 3.46" x 3.08"
JP24845C5E	24-Port T568A/ Universal Wiring	10.69" x 3.46" x 3.08"
JP36845C5E	36-Port T568A/ Universal Wiring	10.69" x 6.94" x 3.08"

Category 5e Wall-Mount Patch Panel with 89D Bracket

CATALOG NUMBER	DESCRIPTION	DIMENSIONS
12845C5E89	12-Port T568A/B Universal Wiring	2.25" x 10" x 1.625"

Dimensions shown are W x H x D.

66 Block

Provides flexibility in network interface connections. Used primarily for cross-connections, 66 blocks provide easy connections between customer voice or data networks and telecommunications equipment.

66 Block & Bracket

CATALOG NUMBER	DESCRIPTION
PS665089V	50-Pair 66 Block, Unwired & Mounting Bracket

Patch Cords

Stranded-wire, twisted-pair construction provides the flexibility to make Cross-connections easy.

CATALOG NUMBER	DESCRIPTION	DIMENSIONS
PCC6_	Category 6, Gray	3', 5', 7', 10', 15'

Add desired length to end of Catalog Number to order, example PCC610.

TECHNICAL SPECIFICATIONS



AFCI Receptacles	U-182
Associations, Organizations & Standards	U-5
Cam-Type Devices	U-135
Configuration & Clocking Systems	U-139
Dimmers	U-169
GFCI Receptacles	U-69
Hallway Lights – Light Output Measurement	U-68
Horsepower Ratings for NEMA	U-12
IP Codes & Their Meaning	U-11
NEMA Configurations	U-8
Network Wiring	U-177
Occupancy Sensors	U-158
Pin & Sleeve/Mechanical Interlock	U-156
Pin & Sleeve/Splashproof	U-148
Pin & Sleeve/Watertight	U-140
Receptacles	U-33
Straight Blade Plugs & Connectors	U-105
Switches	U-23
Symbols	U-7
Turnlok® Plugs, Connectors, Receptacles, Inlets & Outlets	U-114
Surge Protective	U-90
UL Changes, Conversions & Wire Spec Chart	U-10
Wall Plates	U-179
Wiring Diagrams	U-13



TECHNICAL SPECIFICATIONS

Table of Contents

CATEGORY	DESCRIPTION	PAGE NUMBER
AFCI RECEPTACLES		U-182
ASSOCIATIONS, ORGANIZATIONS & STANDARDS		U-5, U-6
CAM-TYPE DEVICES	45° Angled Receptacles	U-135
	Series 15 In-Line Connectors	U-137
	Series 16 In-Line Connectors	U-136
	Series 18 In-Line Connectors	U-138
CONFIGURATION & CLOCKING SYSTEMS		U-139
DIMMERS	Incandescent Rotary Dimmers	U-176
	Titan® Series Fluorescent 2, 3 & 4 Wire	U-171 – U-173
	Titan® Series Incandescent & Magnetic Low-Voltage	U-169, U-170
	Wide Slide Dimmers	U-174, U-175
GFCI RECEPTACLES	Audible Alarm Hospital Grade Tamper-Resistant GFCI Receptacles	U-77
	Audible Alarm Tamper-Resistant GFCI Receptacles	U-76
	Hospital Grade GFCI Receptacles	U-72
	Hospital Grade Tamper-Resistant GFCI Receptacles	U-70
	Hospital Grade Tamper-Resistant Nightlight/GFCI Receptacles	U-74
	Hospital Grade Isolated Ground Tamper-Resistant GFCI Receptacles	U-79
	Isolated Ground Tamper-Resistant GFCI Receptacles	U-78
	NAFTA-Compliant & RoHS-Compliant GFCI Receptacles	U-86
	NAFTA-Compliant Hospital Grade GFCI Receptacles	U-87
	NAFTA-Compliant PlugTail® GFCI Receptacles	U-88
	NAFTA-Compliant PlugTail® Hospital Grade GFCI Receptacles	U-89
	PlugTail® Hospital Grade GFCI Receptacles	U-81
	PlugTail® Hospital Grade Tamper-Resistant GFCI Receptacles	U-83
	PlugTail® Hospital Grade TR Nightlight/GFCI Receptacles	U-85
	PlugTail® Specification Grade GFCI Receptacles	U-80
	PlugTail® Specification Grade Tamper-Resistant GFCI Receptacles	U-82
	PlugTail® Specification Grade TR Nightlight/GFCI Receptacles	U-84
	Tamper-Resistant GFCI Receptacles	U-69
	Tamper-Resistant Nightlight/GFCI Receptacles	U-73
	TradeMaster® & Specification Grade GFCI Receptacles	U-71
	Weather-Resistant GFCI Receptacles	U-75
HALLWAY LIGHTS	Light Output Measurements	U-68
HORSEPOWER RATINGS FOR NEMA		U-12
IP CODES & THEIR MEANINGS		U-11
NEMA CONFIGURATIONS	Straight Blade Devices & Turnlok® Devices	U-8, U-9
NETWORK WIRING	Universal & Six-Pin Wiring Guides & UTP Cabling Installation	U-178
	UTP Outlet Wiring Configurations	U-177
OCCUPANCY SENSORS	Dual-Technology Ceiling Sensor	U-166
	Dual-Technology Wall Switch	U-161
	High Bay Passive Infrared (PIR) Line Voltage Occupancy Sensor	U-167
	Occupancy Sensors	U-158
	Optional Neutral Sensors	U-159
	Passive Infrared Occupancy Ceiling Sensors	U-164
	Passive Infrared Wide Angle & Hallway Sensors	U-162, U-163
	Power Pack & Auxiliary Relay Pack	U-168
	Ultrasonic Ceiling Sensors	U-165
	Wall Switch	U-160

TECHNICAL SPECIFICATIONS

Table of Contents

CATEGORY	DESCRIPTION	PAGE NUMBER
PIN & SLEEVE/ MECHANICAL INTERLOCK	Watertight Pin & Sleeve Non-Fusible Mechanical Interlock	U-156, U-157
PIN & SLEEVE/SPLASHPROOF	Splashproof Pin & Sleeve Connectors	U-152, U-153
	Splashproof Pin & Sleeve Inlets	U-154, U-155
	Splashproof Pin & Sleeve Plugs	U-150, U-151
	Splashproof Pin & Sleeve Receptacles	U-148, U-149
PIN & SLEEVE/WATERTIGHT	Watertight Pin & Sleeve Connectors	U-144, U-145
	Watertight Pin & Sleeve Inlets	U-146, U-147
	Watertight Pin & Sleeve Plugs	U-142, U-143
	Watertight Pin & Sleeve Receptacles	U-140, U-141
RECEPTACLES	Commercial Specification Grade Tamper-Resistant Receptacles	U-65
	Construction Specification Grade Receptacles	U-52
	Extra Heavy-Duty Hospital Grade MRI Receptacles	U-39
	Extra Heavy-Duty Hospital Grade Receptacles	U-38
	Federal Specification Grade USB Charger Tamper-Resistant Receptacle ..	U-33
	Hard Use Specification Grade Receptacles	U-49
	Heavy-Duty Hospital Grade Compact Design Receptacles	U-43
	Heavy-Duty Hospital Grade Receptacles	U-42
	Heavy-Duty Specification Grade Receptacles	U-41
	Heavy-Duty Tamper-Resistant Decorator Receptacles	U-64
	Heavy-Duty Tamper-Resistant Decorator and HG Single Receptacles	U-66
	Hospital Grade Tamper-Resistant Duplex Receptacles	U-44
	Hospital Grade USB Charger with Tamper-Resistant Receptacles	U-34
	Industrial Extra Heavy-Duty Specification Grade Receptacles	U-40
	Plug Load Controllable Decorator Receptacles	U-50
	Plug Load Controllable Receptacles	U-51
	PlugTail® Decorator Receptacles	U-60
	PlugTail® Extra Heavy-Duty HG Illuminated Receptacles	U-37
	PlugTail® Extra Heavy-Duty Hospital Grade Receptacles	U-36
	PlugTail® Extra Heavy-Duty Specification Grade Receptacles	U-35
	PlugTail® Hospital Grade Receptacles	U-47
	PlugTail® Specification & Hospital Grade Receptacles	U-45
	PlugTail® Specification Grade Receptacles Split Circuit	U-48
	PlugTail® Tamper-Resistant Duplex Receptacles	U-61
	PlugTail® Tamper-Resistant Specification & HG Receptacles	U-46
	Specification Grade Combination Receptacles	U-67
	Tamper-Resistant Commercial Grade Receptacles	U-56
	Tamper-Resistant Construction & HG Single Receptacles	U-57
	Tamper-Resistant Hard Use Receptacles	U-55
	Tamper-Resistant Hard Use & Commercial Spec Grade Receptacles	U-53
	Tamper-Resistant Hospital Grade Duplex Receptacles	U-62
	Tamper-Resistant Specification & Hospital Grade Receptacles	U-54
	Tamper-Resistant Split Circuit Duplex Receptacles	U-63
	Weather-Resistant Commercial Grade Receptacles	U-59
	Weather-Resistant Heavy-Duty Receptacles	U-58
STRAIGHT BLADE PLUGS & CONNECTORS	Clamp-Lock™ Plugs & Connectors	U-113
	Ground Continuity Monitoring (GCM) Connectors	U-108
	Ground Continuity Monitoring (GCM) Plugs	U-107
	MaxGrip® M3 Connectors	U-110
	MaxGrip® M3 Plugs	U-109
	Rubber Dust-Tight Plugs & Connectors	U-111
	Watertight Plugs, Connectors & Receptacles	U-112
	Straight Blade Connectors	U-106
	Straight Blade Plugs	U-105

TECHNICAL SPECIFICATIONS

Table of Contents

CATEGORY	DESCRIPTION	PAGE NUMBER
SURGE PROTECTIVE	Extra Heavy-Duty Tamper-Resistant Hospital Grade Receptacles	U-102
	Extra Heavy-Duty Tamper-Resistant Receptacles	U-100
	Hospital Grade Isolated Ground Receptacles	U-91
	Hospital Grade Receptacles	U-90
	PlugTail® Extra Heavy-Duty Receptacles	U-94
	PlugTail® Hospital Grade Extra Heavy-Duty Receptacles	U-96, U-97
	PlugTail® Hospital Grade Isolated Ground Receptacles	U-98
	PlugTail® Hospital Grade Tamper-Resistant Receptacles	U-99
	PlugTail® Isolated Ground Receptacles	U-95
	Specification Grade Extra Heavy-Duty Receptacles	U-92
	Specification Grade Isolated Ground Receptacles	U-93
	Surge Protection Panels	U-104
	Tamper-Resistant Hospital Grade Isolated Ground Receptacles	U-103
	Tamper-Resistant Isolated Ground Receptacles	U-101
	SWITCHES	Commercial Specification Grade Switches
Hard-Use Specification Grade Switches		U-26
Industrial Extra Heavy-Duty Specification Grade Switches		U-24, U-25
Manual Controller Switches		U-28, U-29
PlugTail® Specification Grade Decorator Switches		U-30
PlugTail® Specification Grade Switches		U-23
Specification Grade Combination & Contact Switches		U-32
Specification Grade Decorator Switches		U-31
SYMBOLS		U-7
TURNLOK® PLUGS, CONNECTORS, RECEPTACLES, INLETS & OUTLETS	15, 20 & 30A Heavy-Duty Ground Continuity Monitoring (GCM) Connectors	U-123
	15, 20 & 30A Heavy-Duty Ground Continuity Monitoring (GCM) Plugs	U-122
	15A Turnlok® EHU Plugs & Connectors	U-117
	15A Turnlok® Flanged Inlets & Outlets	U-124
	15A Turnlok® Receptacles	U-114
	20A Turnlok® Connectors	U-119
	20A Turnlok® Flanged Inlets	U-125
	20A Turnlok® Flanged Outlets	U-126
	20A Turnlok® Plugs	U-118
	20A Turnlok® Receptacles	U-115
	30A Turnlok® Connectors	U-121
	30A Turnlok® Flanged Inlets	U-127
	30A Turnlok® Flanged Outlets	U-128
	30A Turnlok® Plugs	U-120
	30A Turnlok® Receptacles	U-116
	California Standard & Corrosion-Resistant Devices	U-132, U-133
	Power Interrupting Devices	U-134
	Turnlok® Rubber Dust-Tight Plugs & Connectors	U-129
Turnlok® Watertight Plugs, Connectors & Receptacles	U-130, U-131	
UL CHANGES, CONVERSIONS & WIRE SPEC CHART		U-10
WALL PLATES	Dimensions	U-181
	Specifications	U-179, U-180
WIRING DIAGRAMS		U-13 – U-22

Devices & Wall Plates Color Selection Chart available on Pages A-29, B-84 and S-58.

TECHNICAL SPECIFICATIONS

Associations, Organizations, & Standards

For convenience, the following listings define common acronyms for a variety of organizations.

Standards Development Organization

Organizations primarily involved in the development and/or promulgation of standards.

NFPA	National Fire Protection Agency
IEC	International Electrotechnical Commission
IEEE	Institute of Electrical and Electronics Engineers, Inc.
ANSI	American National Standards Institute
CANENA	Consejo de Armonizacion de Normas Electrotecnicas de Naciones America (Council for Harmonization of Electrotechnical Standardization of the Nations of the Americas)
SAE	Society of Automotive Engineers
ISA	Instrument Society of America
SME	Society of Manufacturing Engineers
ISO	International Standards Organization

Codes & Standards

Installation codes and product safety, performance on interchangeability standards.

NEC	National Electrical Code
NOM	Normas Oficiales de Mexicanas (Official Mexican Standard)
NMX	Normas Mexicanas
CEC	Canadian Electrical Code

Industry Associations

Associations of companies or individuals for the purpose of standardization, trade and professional development, etc.

NMDA	National Marine Distributor Association
NEMA	National Electrical Manufacturers Association
ABYC	American Boat and Yacht Council
EIA/TIA	Electronics Industry Association/Telecommunications Industry Association
NAED	National Association of Electrical Distributors
NAW	National Association of Wholesalers
BICSI	Building Industry Consulting Services International
IBI	Intelligent Building Institute
EPRI	Electric Power Research Institute
ESFI	Electrical Safety Foundation International
NEMRA	National Electrical Manufacturers Representatives Association
IAEI	International Association of Electrical Inspectors
IFMA	International Facilities Management Association
BOMA	Building Owner Management Association
SEMI	Semi-Conductor Equipment and Material International
CEMRA	Canadian Electrical Manufacturers Representative Association
NMRA	National Marine Representative Association
EFI	Electro-Federation Incorporated
NECA	National Electrical Contractors Association
IECA	Independent Electrical Contractors Association
ECOC	Electrical Contractors of Canada
CANAME	Camara Nacional de Manufacturas Electricas
HLCA	Home Lighting Control Alliance
USGBC	U.S. Green Building Council

TECHNICAL SPECIFICATIONS

Associations, Organizations, & Standards

Certification Agencies

Primarily involved in certification of products or manufacturers to standards developed by the certification agency or by others.

UL	Underwriters' Laboratories, Inc.
cUL	Tested to Canadian Safety Standards by Underwriters' Laboratories, Inc.
cULus	Tested to U.S. and Canadian Safety Standards by Underwriters' Laboratories, Inc.
CSA	Canadian Standards Association
ANCE	National Association of Normalization and Certification of the Electrical Sector, (Mexico)
TUV	TUV Rheinland of N.A., Inc.
VDE	Verband Deutscher Elektrotechniker
BSI	British Standards Institute
FM	Factory Mutual
NRTL	Nationally Recognized Testing Laboratories

Government Agencies

OSHA	Occupational Safety and Health Administration
FCC	Federal Communications Commission
DSSC	Defense Supply Center, Columbus
IAPA	Independent Accident and Protection Association (Canada)
LEED	Leadership in Energy and Environmental Design

Copies of standards referred to on the preceding pages may be purchased from the following:

Underwriters' Laboratories, Inc. (UL)

1285 Walt Whitman Road
Melville, NY 11747

333 Pfingston Road
Northbrook, IL 60062

1655 Scott Boulevard
Santa Clara, CA 95050

12 Laboratory Drive
Research Triangle Park, NC 27709

2600 N.W. Lake Road
Camas, WA 98607

The Canadian Standards Association (CSA)

Standards Division
178 Rexdale Boulevard
Rexdale, Ontario
Canada M9W 1R3

The American National Standards Institute (ANSI)

1430 Broadway
New York, NY 10018

National Electrical Manufacturers Association (NEMA)

2101 L Street, NW, Suite 300
Washington, DC 20037

National Fire Protection Association (NFPA)

Batterymarch Park
Quincy, MA 02269

The International Electrotechnical Commission (IEC)

Copies of IEC standards may be obtained from the American National Standards Institute (ANSI) at the above address.

American Boat and Yacht Council, Inc. (ABYC)

P.O. Box 806
Amityville, NY 11701

Asociacion Nacional de Normalizacion y Certificacion del Sector Electrico A.C. (NOM-ANCE)

Insurgentes Sur 664, 3ER Piso
Col. Del Valle
03100 Mexico D.F.
Phone: 011-525-227-1110
Fax: 011-525-227-1177

Occupational Safety and Health Administration

200 Constitution Avenue N.W.
Room 3647
Washington, DC 20210

TECHNICAL SPECIFICATIONS

Symbols Electrical Symbols & Abbreviations In Accordance with American National Standards Institute

General Outlets

- Outlet
- Blanked Outlet
- Drop Cord
- Electrical Outlet: for use only when circle used alone might be confused with columns, plumbing symbols, etc.
- Fan Outlet
- Junction Box
- Lamp Holder
- Lamp Holder with Pull Switch
- Pull Switch
- Outlet for Vapor Discharge Lamp
- Exit Light Outlet
- Clock Outlet (Specify Voltage)

Convenience Outlets

- Duplex Convenience Outlet
- Convenience Outlet other than Duplex
1 = Single, 3 = Triplex, etc.
- Weatherproof Convenience Outlet
- Range Outlet
- Switch and Convenience Outlet
- Radio and Convenience Outlet
- Special Purpose Outlet
- Floor Outlet

Switch Outlets

- S Single Pole Switch
- S₂ Double Pole Switch
- S₃ Three Way Switch
- S₄ Four Way Switch
- S_D Automatic Door Switch
- S_E Electroliner Switch
- S_K Key Operated Switch
- S_P Switch and Pilot Lamp
- S_{CB} Circuit Breaker
- S_{WCB} Weatherproof Circuit Breaker
- S_{MC} Momentary Contact Switch
- S_{RC} Remote Control Switch
- S_{WP} Weatherproof Switch
- S_F Fused Switch
- S_{WF} Weatherproof Fused Switch

Special Outlets

- Any Standard Symbol as given above with the addition of a lower case subscript letter may be used to designate some special variation of Standard Equipment of particular interest in a specific set of Architectural Plans. When used they must be listed in the Key of Symbols on each drawing and if necessary further described in the specifications.

Panels, Circuits & Miscellaneous

- Lighting Panel
- Power Panel
- Branch Circuit: Concealed in Ceiling or Wall
- Branch Circuit: Concealed in Floor
- Branch Circuit: Exposed
- Home Run to Panel Board. Indicate number of Circuits by number of arrows.
Note: Any circuit without further designation indicates a two-wire circuit. For a greater number of wires indicate as follows:
/// (3 wires), /// (4 wires), etc.
- Feeders: **Note:** Use heavy lines and designate by number corresponding to listing in Feeder Schedule.
- Underfloor Duct and Junction Box. Triple System.
Note: For double or single systems eliminate one or two lines. This symbol is equally adaptable to auxiliary system layouts.
- Generator
- Motor
- Instrument
- Power Transformer. (Or draw to scale.)
- Controller
- Isolating Switch

Auxiliary Systems

- Push Button
- Buzzer
- Bell
- Annunciator
- Outside Telephone
- Interconnecting Telephone
- Telephone Switchboard
- Bell Ringing Transformer
- Electric Door Opener
- Fire Alarm Bell
- Fire Alarm Station
- City Fire Alarm Station
- Fire Alarm Central Station
- Automatic Fire Alarm Device
- Watchman's Station
- Watchman's Central Station
- Horn
- Nurse's Signal Plug
- Maid's Signal Plug
- Radio Outlet
- Signal Central Station
- Interconnection Box
- Battery

Auxiliary System Circuits

- Note:** Any line without further designation indicates System. For a greater number of wires designate with numerals in manner similar to 12-No. 18 W-3/4" C., or designate by number corresponding to listing in Schedule.
- Special Auxiliary Outlets
Subscript letters refer to notes on plans or detailed description in specifications.

TECHNICAL SPECIFICATIONS

NEMA Configurations – Straight Blade Devices

Straight Blade Plugs & Receptacles

	15 AMPERE		20 AMPERE		30 AMPERE		50 AMPERE		60 AMPERE	
	RECEPTACLE	PLUG	RECEPTACLE	PLUG	RECEPTACLE	PLUG	RECEPTACLE	PLUG	RECEPTACLE	PLUG
2 POLE, 2 WIRE NON-GROUNDING										
125V	1	1-15R	1-15P							
	2									
250V										
2 POLE, 3 WIRE GROUNDING										
125V	5	5-15R	5-15P	5-20R	5-20P	5-30R	5-30P		5-50P	
	250V	6-15R	6-15P	6-20R	6-20P	6-30R	6-30P	6-50R	6-50P	
277VAC	7	7-15R	7-15P	7-20R	7-20P	7-30P		7-50P		
3 POLE, 3 WIRE NON-GROUNDING										
125/250V	10			10-20R	10-20P	10-30R	10-30P	10-50R	10-50P	
3 POLE, 4 WIRE GROUNDING										
125/250V	14			14-20R	14-20P	14-30R	14-30P	14-50R	14-50P	14-60P
	3Ø250V	15			15-20P	15-30P	15-50P	15-60R	15-60P	
4 POLE, 4 WIRE NON-GROUNDING										
3ØY 120/208V	18			18-20R	18-20P				18-60R	18-60P

Labels and Their Meanings

X, Y, Z	Hot Lead
W	Neutral Lead
G	Grounding Lead

Open Slots

Indicate receptacle configurations (female).



Closed Slots

Indicate plug blade configurations (male).

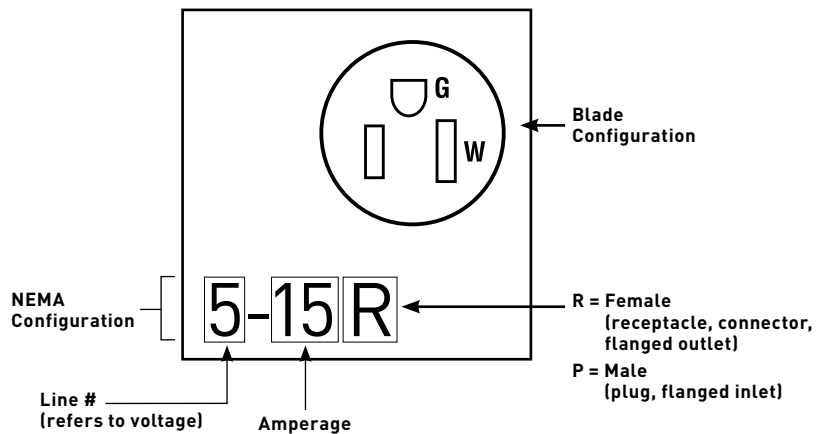

TECHNICAL SPECIFICATIONS

NEMA Configurations – Turnlok® Devices

Locking Plugs & Receptacles

	15 AMPERE		20 AMPERE		30 AMPERE	
	RECEPTACLE	PLUG	RECEPTACLE	PLUG	RECEPTACLE	PLUG
2 POLE, 2 WIRE NON-GROUNDING						
125V	L1					
	L2					
2 POLE, 3 WIRE GROUNDING						
125V	L5					
	L6					
250V	L7					
	L24					
347VAC	L8					
	L9					
480VAC	L10					
	L11					
600VAC	L12					
	L13					
3 POLE, 3 WIRE NON-GROUNDING						
125/250V	L10					
	L11					
3ø250V	L12					
	L13					
3ø480V	L14					
	L15					
3ø600V	L16					
	L17					
3 POLE, 4 WIRE NON-GROUNDING						
125/250V	L14					
	L15					
3ø250V	L16					
	L17					
3ø480V	L18					
	L19					
3ø600V	L20					
	L21					
4 POLE, 4 WIRE NON-GROUNDING						
3øY 120/208V	L18					
	L19					
3øY 277/480V	L20					
	L21					
3øY 347/600V	L22					
	L23					
4 POLE, 5 WIRE NON-GROUNDING						
3øY 120/208V	L21					
	L22					
3øY 277/480V	L23					
	L24					

Midget – Locking

	15 AMPERE	
	RECEPTACLE	PLUG
2 POLE, 2 WIRE NON-GROUNDING		
125V	ML1	
	ML2	
2 POLE, 3 WIRE GROUNDING		
125V	ML2	
	ML3	
3 POLE, 3 WIRE NON-GROUNDING		
125/250V	ML3	
	ML4	

Labels and Their Meanings

X, Y, Z	Hot Lead
W	Neutral Lead
G	Grounding Lead

Open Slots

Indicate receptacle configurations (female).



Closed Slots

Indicate plug blade configurations (male).



TECHNICAL SPECIFICATIONS

UL Changes, Conversion & Wire Spec Chart

UL Rating Changes

On July 1, 1983, UL cancelled listing of 3 non-NEMA dual-rated configurations and assigned new voltage ratings to them. There is no change in the slot/blade configurations and the catalog numbers for each series are now UL listed under their new voltage ratings. Affected configurations are:

1. 30A, 3 Pole, 3 Wire
not grounding Turnlok®
No. 3330 Series



***Old Rating**
30A, 250V



New Rating
30A, 125/250V

2. 20A, 4 Pole, 4 Wire
not grounding Turnlok®
No. 7410 Series

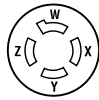

***Old Rating**
20A, 250V
10A, 600V

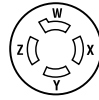

New Rating
20A, 120/208V
3øY

3. 30A, 4 Pole, 4 Wire
not grounding Turnlok®
No. 3430 Series

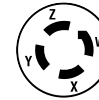

***Old Rating**
30A, 600V
30A, 250V

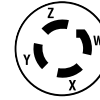

New Rating
30A, 120/208V
3øY

Conversion Chart

Fractions to Decimals to Millimeters

INCHES FRACTION	DECIMAL	MM	INCHES FRACTION	DECIMAL	MM	INCHES FRACTION	DECIMAL	MM	INCHES FRACTION	DECIMAL	MM
1/64	0.0156	0.3969	17/64	0.2656	6.7469	33/64	0.5156	13.0969	49/64	0.7656	19.4469
1/32	0.0312	0.7938	9/32	0.2812	7.1438	17/32	0.5312	13.4938	25/32	0.7812	19.8437
3/64	0.0468	1.1906	19/64	0.2968	7.5406	35/64	0.5468	13.8906	51/64	0.7968	20.2406
1/16	0.0625	1.5875	5/16	0.3125	7.9375	9/16	0.5625	14.2875	13/16	0.8125	20.6375
5/64	0.0781	1.9844	21/64	0.3281	8.3344	37/64	0.5781	14.6844	53/64	0.8281	21.0344
3/32	0.0937	2.3812	11/32	0.3437	8.7312	19/32	0.5937	15.0812	27/32	0.8437	21.4312
7/64	0.1093	2.7781	23/64	0.3593	9.1281	39/64	0.6093	15.4781	55/64	0.8593	21.8281
1/8	0.1250	3.1750	3/8	0.3750	9.5250	5/8	0.6250	15.8750	7/8	0.8750	22.2250
9/64	0.1406	3.5719	25/64	0.3906	9.9219	41/64	0.6406	16.2719	57/64	0.8906	22.6219
5/32	0.1562	3.9688	13/32	0.4062	10.3188	21/32	0.6562	16.6688	29/32	0.9062	23.0188
11/64	0.1718	4.3656	27/64	0.4218	10.7156	43/64	0.6718	17.0656	59/64	0.9218	23.4156
3/16	0.1875	4.7625	7/16	0.4375	11.1125	11/16	0.6875	17.4625	15/16	0.9375	23.8125
13/64	0.2031	5.1594	29/64	0.4531	11.5094	45/64	0.7031	17.8594	61/64	0.9531	24.2094
7/32	0.2187	5.5562	15/32	0.4687	11.9062	23/32	0.7187	18.2562	31/32	0.9687	24.6062
15/64	0.2343	5.9531	31/64	0.4843	12.3031	47/64	0.7343	18.6531	63/64	0.9843	25.0031
1/4	0.2500	6.3500	1/2	0.5000	12.7000	3/4	0.7500	19.0500	1	1.0000	25.4000

Wire Specifications

Diameter Ranges of Jacketed Cord in Accordance with Standard "UL62"

TYPE*	AWG SIZE	2 COND.	3 COND.
SV,SVO,SVT,SVTO	18	.220-.255"	.230-.265"
	17	.235-.270"	.250-.285"

TYPE*	AWG SIZE	2 COND.	3 COND.	4 COND.
SJ,SJO,SJT,SJTO	18	.280-.315"	.300-.335"	.325-.365"
	17	.290-.325"	.310-.345"	.340-.380"
	16	.305-.340"	.325-.360"	.350-.395"
	15	.315-.350"	.335-.375"	.370-.415"
	14	.335-.375"	.360-.395"	.390-.435"
	12	.405-.455"	.425-.475"	.465-.520"
	10	.540-.605"	.565-.635"	.625-.700"

TYPE*	AWG SIZE	2 COND.	3 COND.	4 COND.	5 COND.
S,SO,ST,STO	18	.340-.385"	.360-.400"	.385-.430"	.460-.510"
	17	.350-.390"	.370-.415"	.400-.445"	.465-.520"
	16	.365-.410"	.385-.430"	.410-.460"	.490-.550"
	15	.475-.530"	.500-.560"	.540-.610"	.615-.690"
	14	.495-.550"	.520-.575"	.560-.620"	.630-.705"
	12	.565-.625"	.590-.655"	.640-.710"	.700-.770"
	10	.615-.685"	.650-.720"	.700-.775"	.760-.840"
	8	.780-.880"	.830-.930"	.925-1.050"	1.000-1.150"
	6	.920-1.050"	.970-1.100"	1.050-1.200"	1.180-1.330"
	4	1.060-1.210"	1.130-1.280"	1.250-1.450"	
2	1.210-1.400"	1.300-1.500"	1.450-1.650"		

*Actual sizes will vary by cord manufacturers.

TECHNICAL SPECIFICATIONS

IP Codes & Their Meanings

IP Suitability Rating

IP Suitability Ratings are an international system for classifying the degree of protection provided by enclosures of electrical equipment. The higher the number, the greater the degree of protection; they apply **ONLY** to properly installed equipment. The numerals stand for the following:

1. First Number: Degree of protection for persons against access to hazardous parts inside the enclosure and/or against solid bodies.
2. Second Number: Degree of protection of equipment inside enclosures against damage from the ingress of water.

Example: IP44=Ingress Protection; Solid bodies \geq 1.0mm; Splashing

IP44
Suitability

Meaning for the Protection of Equipment

CODE LETTERS	FIRST NUMBER	SECOND NUMBER
Ingress Protection	Against Ingress of Solid Bodies	Against Ingress of Water with Harmful Effects
IP	0 - Non-protected 1 - \geq 50 mm diameter 2 - \geq 12.5 mm diameter 3 - \geq 2.5 mm diameter 4 - \geq 1.0 mm 5 - Dust-protected 6 - Dust-tight	0 - Non-protected 1 - Vertically dripping 2 - Dripping (15° Tilted) 3 - Spraying 4 - Splashing 5 - Jetting 6 - Power jetting 7 - Temporary immersion 8 - Continuous immersion

Note: \geq denotes greater than or equal to. Dimensions in Inches (mm)

TECHNICAL SPECIFICATIONS

Horsepower Ratings for NEMA Configuration Receptacles & Plugs Only

AMPERE RATING	AC VOLTAGE RATING	PHASES	POLES	HORSEPOWER RATING	NEMA DESIGNATION
15	125	1	2	1/2	1-15, L1-15, 5-15, L5-15
	250	1	2	1-1/2#	6-15, L6-15
	277	1	2	2	7-15, L7-15
	125/250	1	3	1-1/2 L-L# 1/2 L-N	14-15
	250	3	3	2	11-15, L11-15, 15-15
	120/208	3	4	2	18-15
20	125	1	2	1	5-20, L5-20
	250	1	2	2#	2-20, L2-20, 6-20, L6-20
	277	1	2	2	7-20, L7-20
	480	1	2	3	L8-20
	125/250	1	3	2 L-L# 1 L-N	10-20, L10-20, 14-20, L14-20
	250	3	3	3	11-20, L11-20, 15-20, L15-20
	480	3	3	5	L12-20, L16-20
	120/208	3	4	2	18-20, L18-20, L21-20
277/480	3	4	5	L19-20, L22-20	
30	125	1	2	2	5-30, L5-30
	250	1	2	2#	2-30, 6-30, L6-30
	277	1	2	3	7-30, L7-30
	480	1	2	5	L8-30
	125/250	1	3	2 L-L# 2 L-N	10-30, L10-30 14-30, L14-30
	250	3	3	3	11-30, L11-30, 15-30, L15-30
	480	3	3	10	L12-30, L16-30
	120/208	3	4	3	18-30, L18-30, L21-30
	277/480	3	4	10	L19-30, L22-30
	50	125	1	2	2
250		1	2	3	6-50
277		1	2	5	7-50
125/250		1	3	3 L-L# 2 L-N	10-50, 14-50
250		3	3	7-1/2	11-50, 15-50
120/208		3	4	7-1/2	18-50
60	125/250	1	3	3 L-L# 2 L-N	14-60
	250	3	3	10	15-60
	120/208	3	4	7-1/2	18-60

L-L: Motor connected line-to-line.

L-N: Motor connected line-to-neutral.

#: Also suitable for 208V motor applications at the indicated horsepower rating.

TECHNICAL SPECIFICATIONS

Wiring Diagrams – Switches & Receptacles

Switches

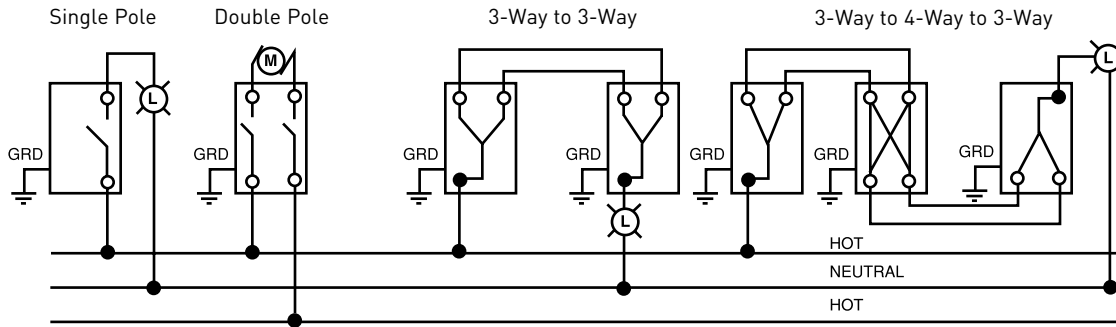

Pilot Light Switch & Lighted Toggle Switch

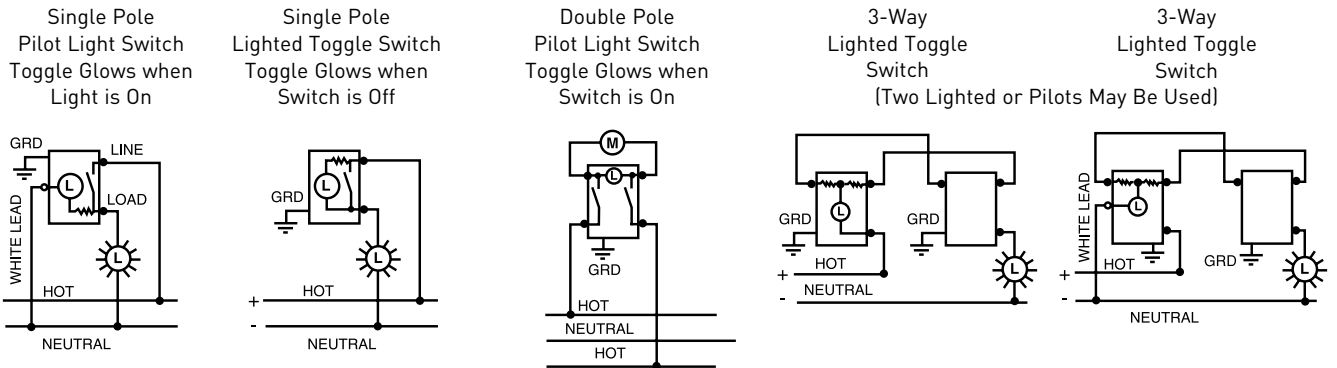

Maintained & Momentary Contact

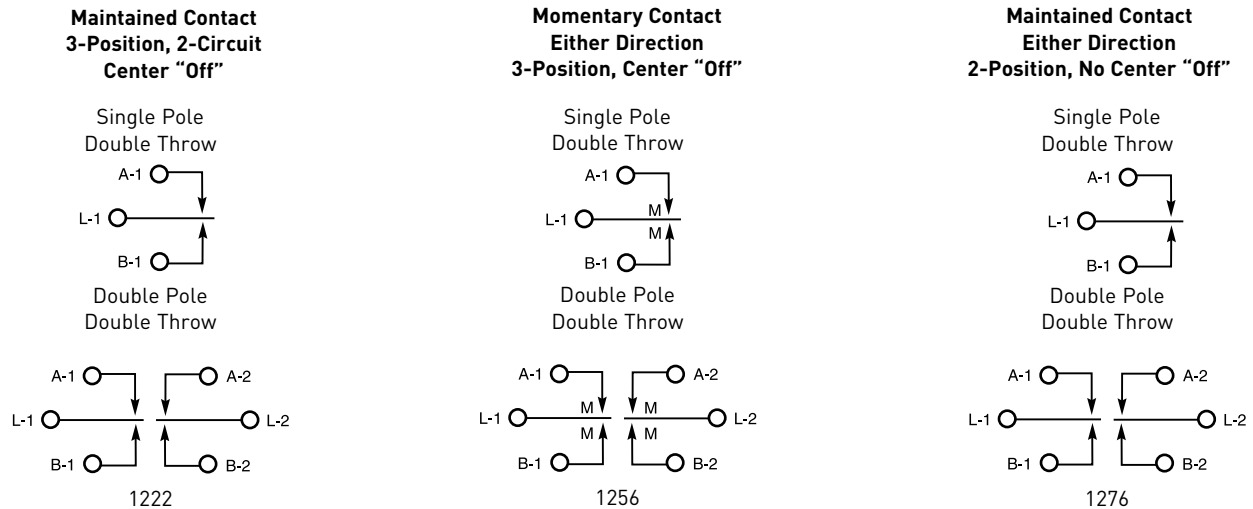

Receptacles

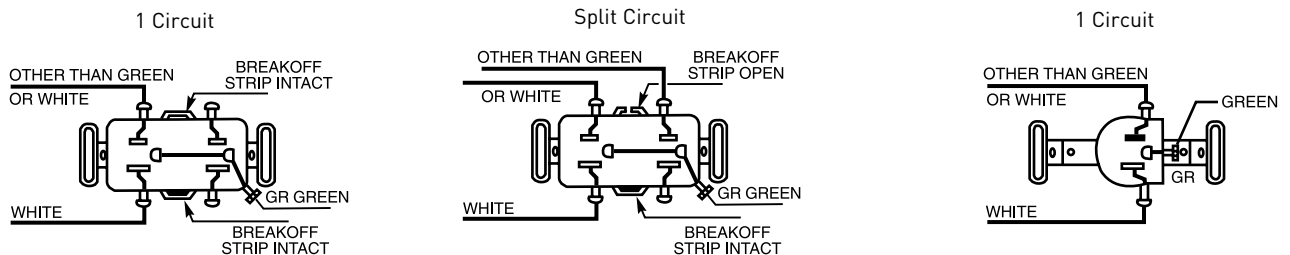

TECHNICAL SPECIFICATIONS

Wiring Diagrams – GFCIs

Wiring Diagram GFCI Receptacle, Feed-Thru Installation

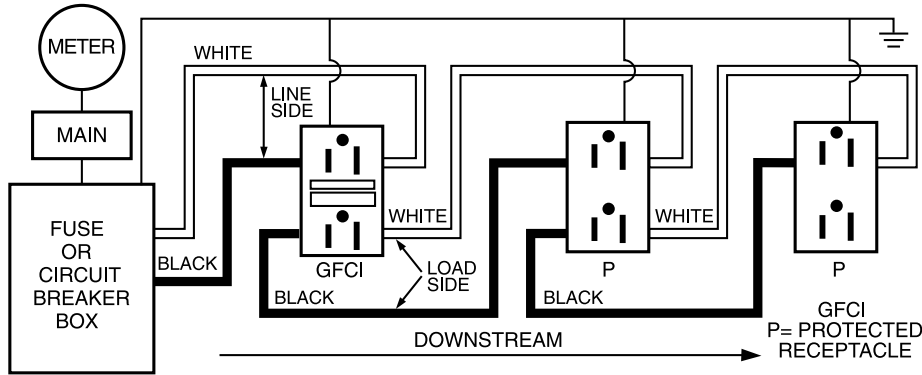

To protect the entire branch circuit the GFCI must be the first receptacle from the fuse or circuit breaker box. Receptacles on the circuit between the GFCI and the box will not be protected, but receptacles downstream from the GFCI will have protection.

Wiring Diagram GFCI Receptacle, Non-Feed-Thru Installation

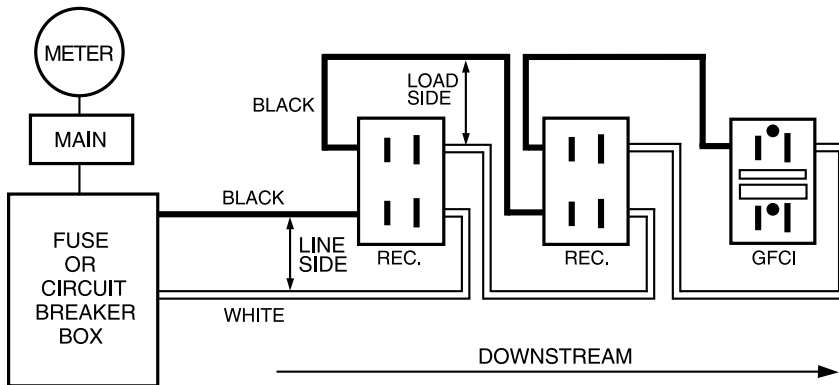

Terminal, or one-outlet-only protection can be achieved on a multi-outlet circuit by connecting the hot and neutral line conductors to the corresponding line side terminals of the GFCI. Only the GFCI receptacle will be protected.

TECHNICAL SPECIFICATIONS

Wiring Diagrams – 2 Pole, 2 Wire Non-Grounding; 3 Pole, 3 Wire Non-Grounding

2 Pole, 2 Wire Non-Grounding

125V

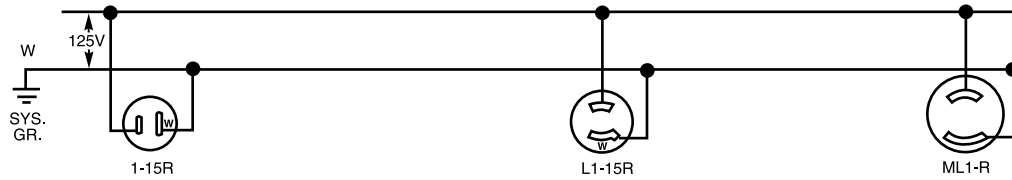

250V

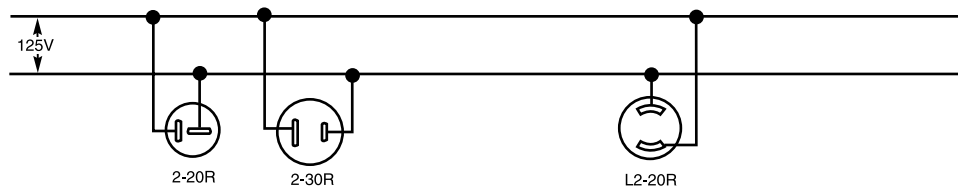

3 Pole, 3 Wire Non-Grounding

125V/250V

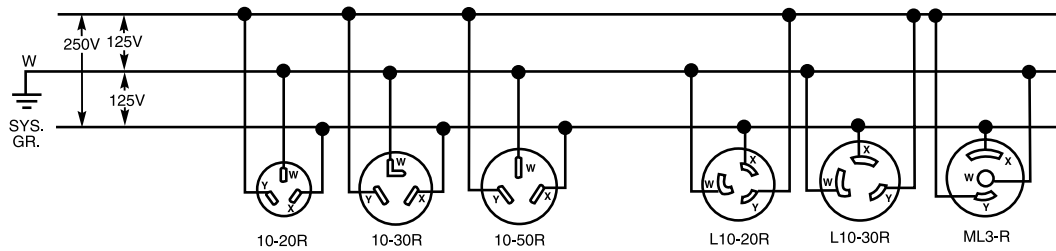

3ø250V

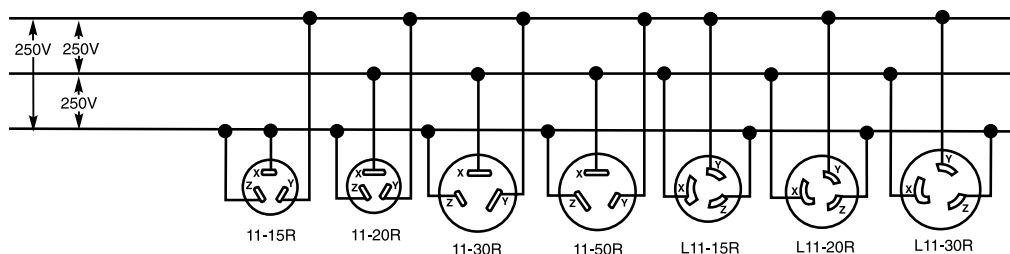

TECHNICAL SPECIFICATIONS

Wiring Diagrams – 2 Pole, 3 Wire Grounding

2 Pole, 3 Wire Grounding

125V

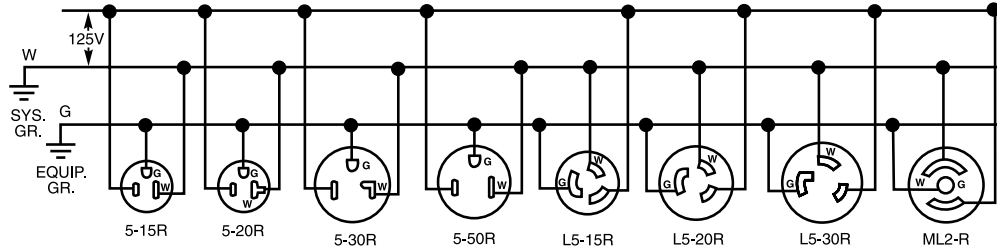

250V

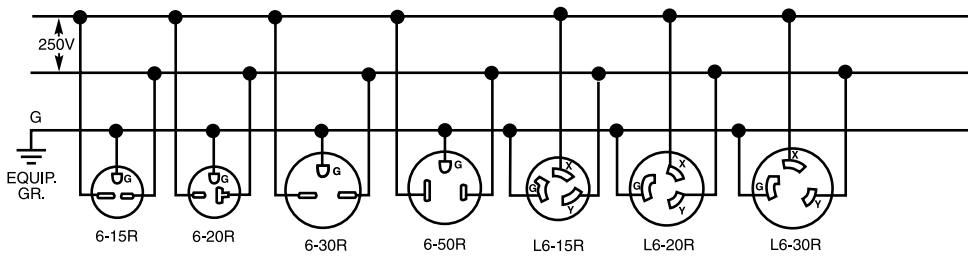

277VAC

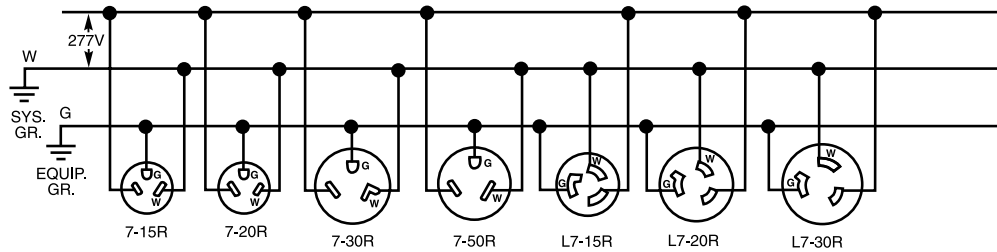

480VAC

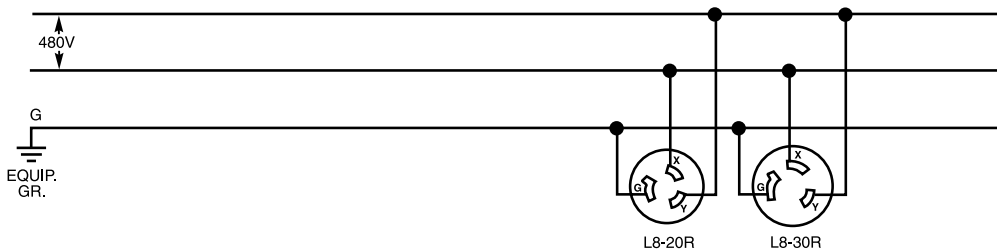

TECHNICAL SPECIFICATIONS

Wiring Diagrams – 3 Pole, 4 Wire Grounding

3 Pole, 4 Wire Grounding

125V/250V

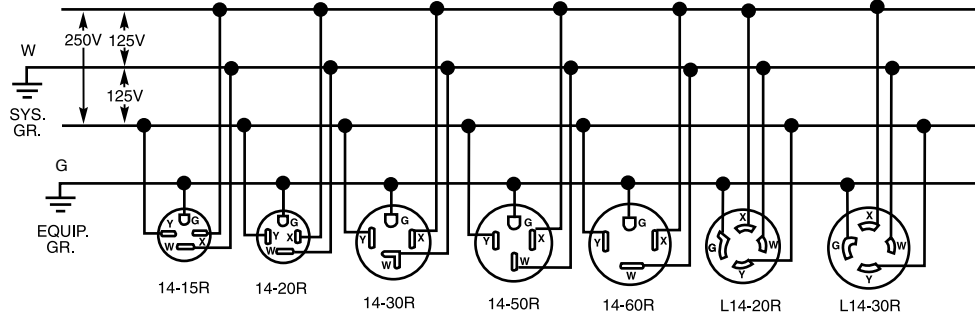

3ø250V

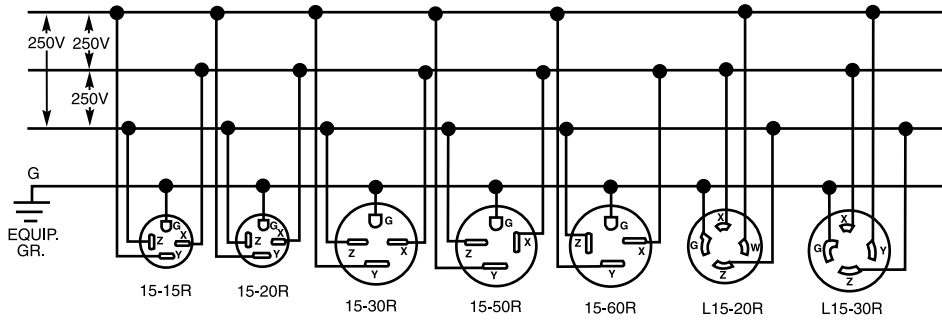

3ø480V

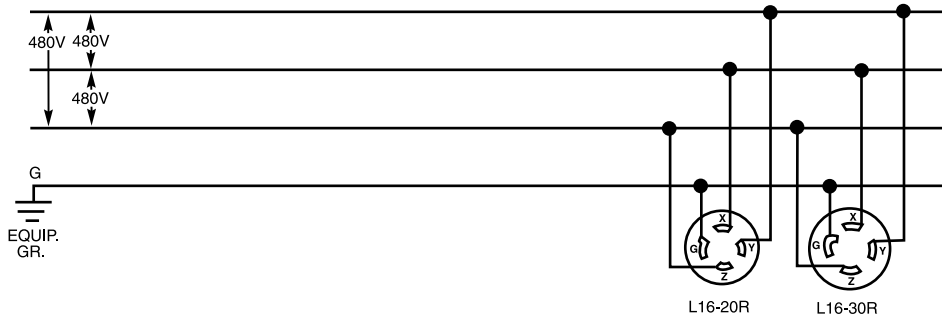

3ø600V

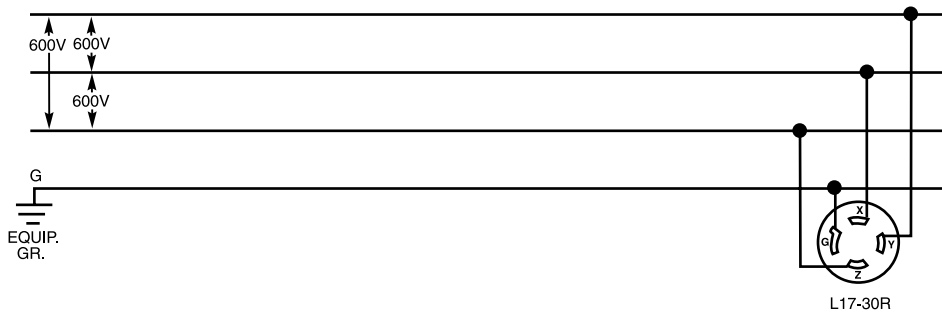

TECHNICAL SPECIFICATIONS

Wiring Diagrams – 4 Pole, 4 Wire Non-Grounding

4 Pole, 4 Wire Non-Grounding

3 ϕ Y120V/208V

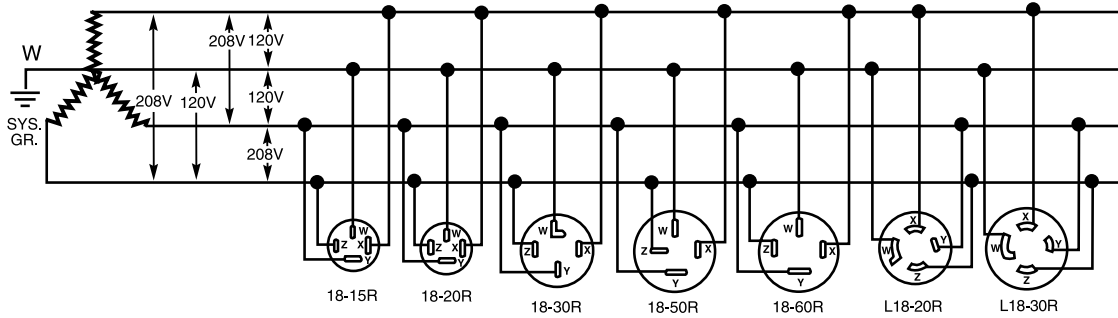

3 ϕ Y277/480V

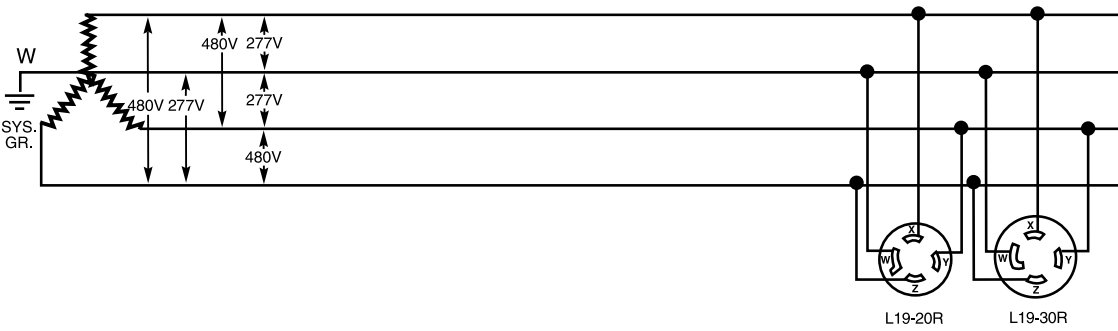

3 ϕ 347/600V

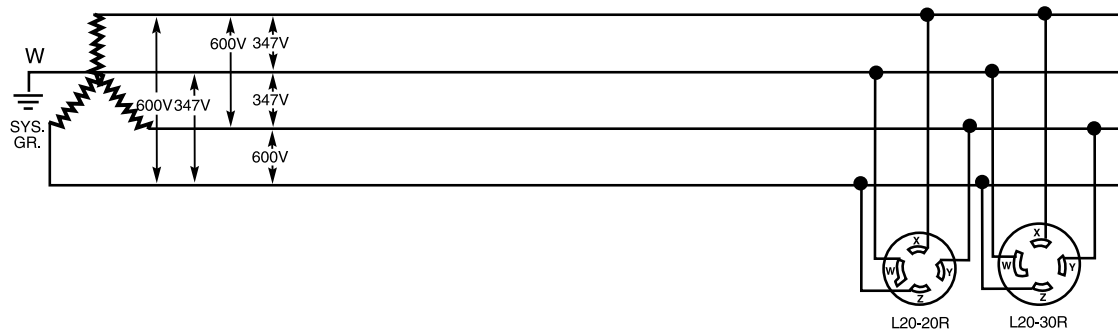

TECHNICAL SPECIFICATIONS

Wiring Diagrams – 4 Pole, 5 Wire Grounding

4 Pole, 5 Wire Grounding

3 ϕ Y120V/208V

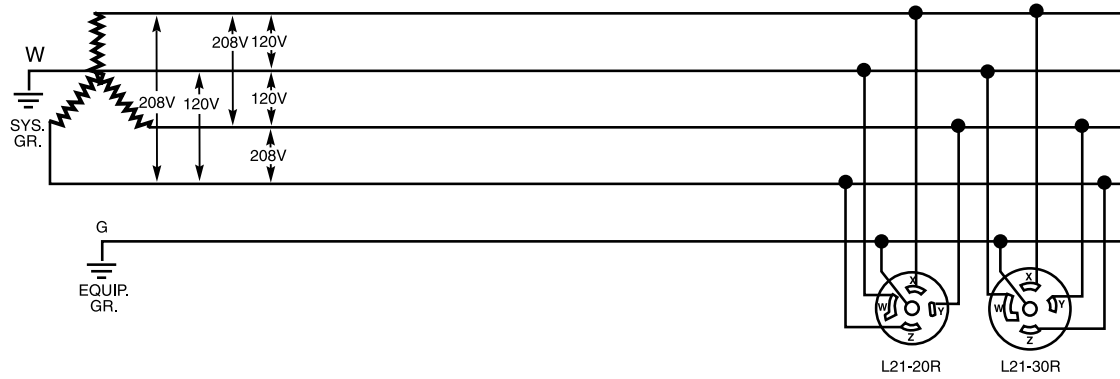

3 ϕ Y277/480V

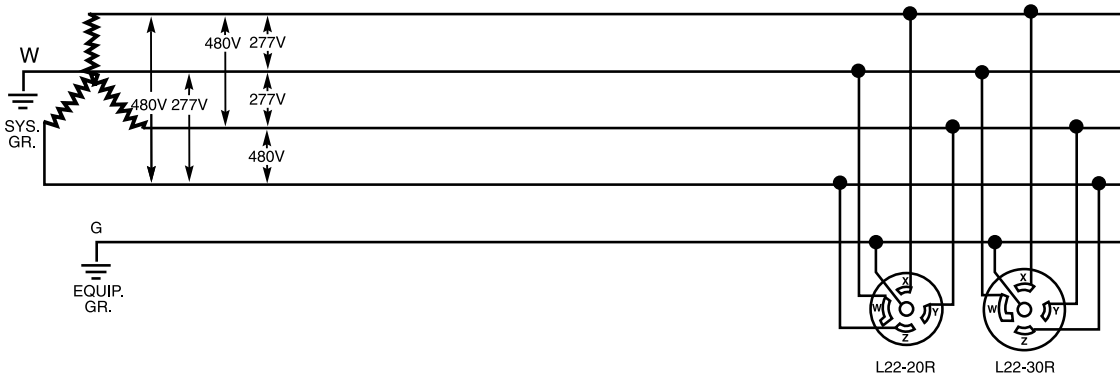

3 ϕ Y347/600V

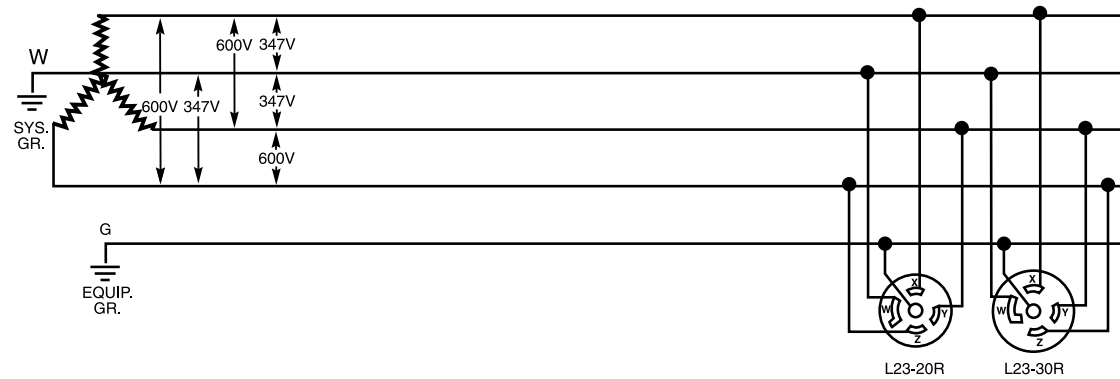

TECHNICAL SPECIFICATIONS

Wiring Diagrams – Sensors Connected to Power Packs

1 Sensor, 1 Power Pack

Standard Wiring

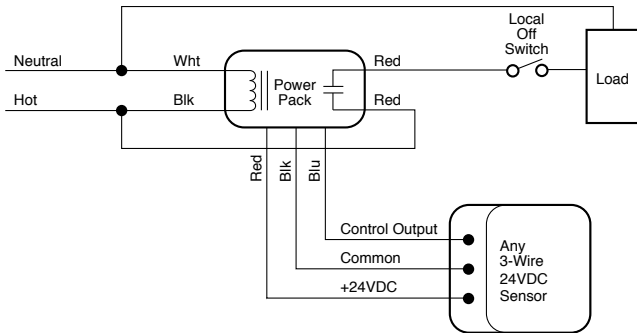

1 Sensor, 1 Power Pack

Bi-Level Lighting

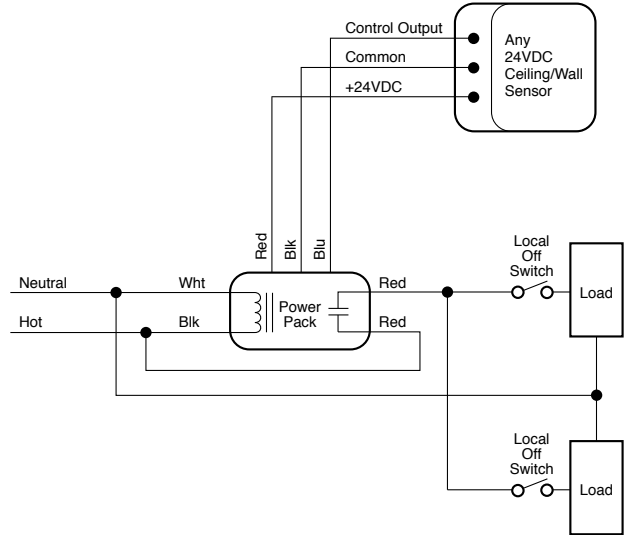

1 Sensor, 1 Power Pack

3-Way Switching

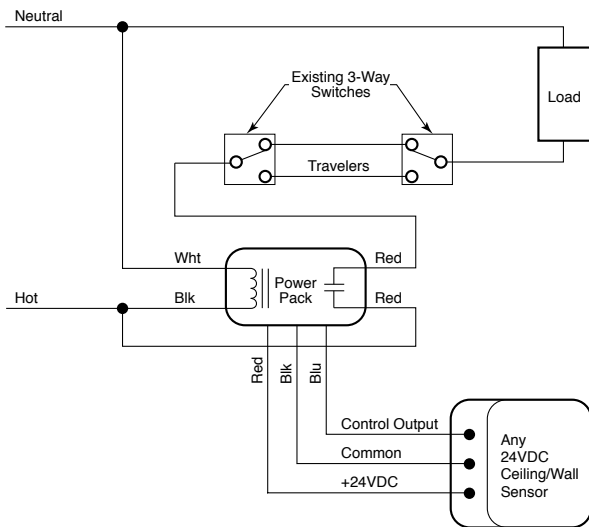

1 Sensor, 1 Power Pack

2 Lighting Loads

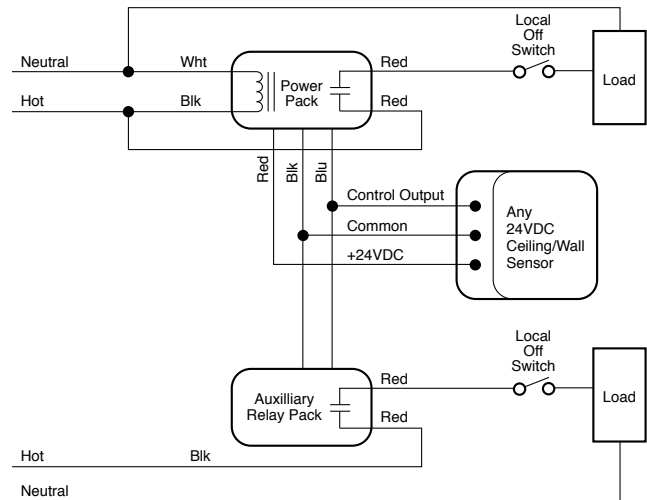

TECHNICAL SPECIFICATIONS

Wiring Diagrams – Sensors Connected to Power Packs

1 Sensor & Up to 3 Power Packs

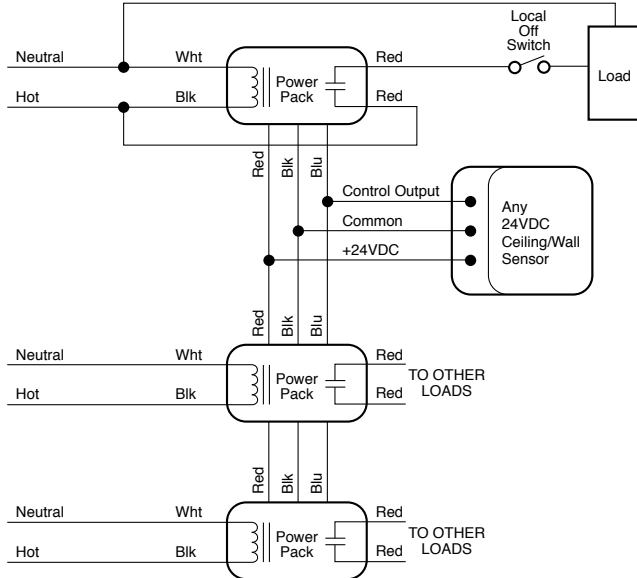

Multiple Sensors, 1 Power Pack

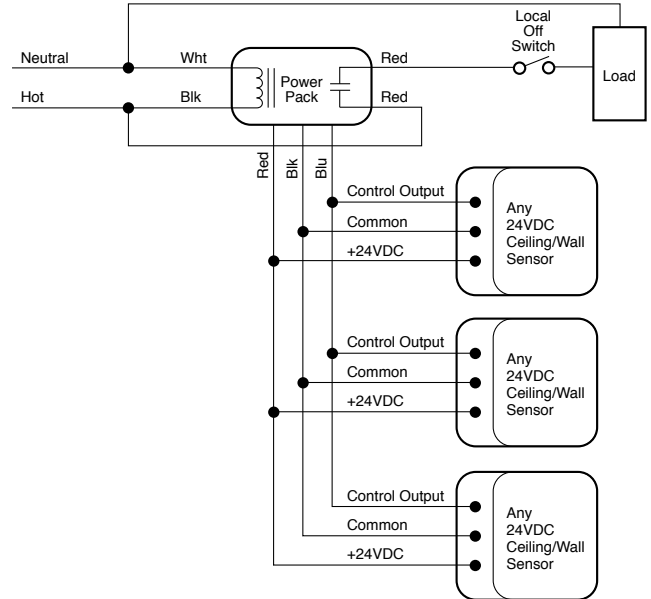

Multiple Sensors, Multiple Power Packs

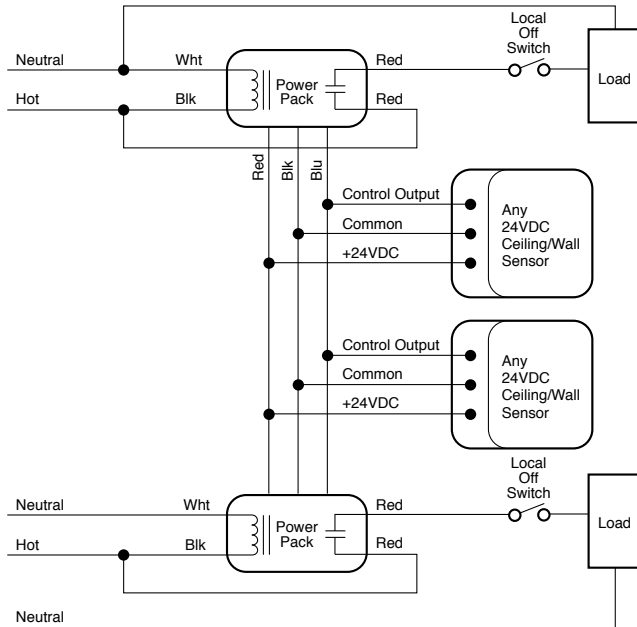

TECHNICAL SPECIFICATIONS

Wiring Diagrams – Dimmers & Fan Speed Controls

Single-Pole Wiring

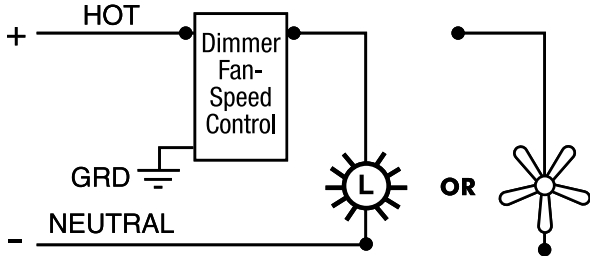

Single-Pole Wiring Using 3-Way Preset Dimmer

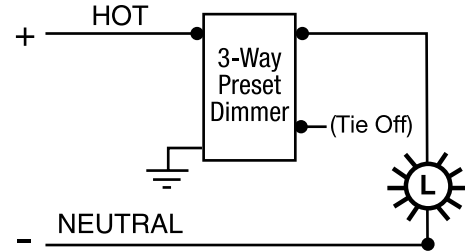

3-Way Wiring

Control Line Side

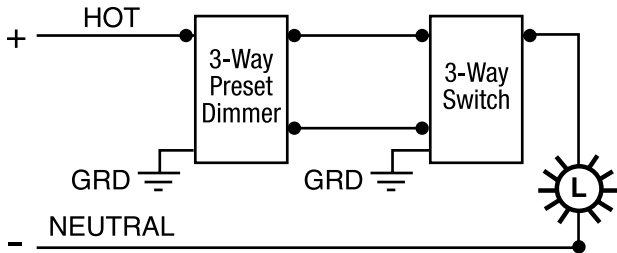

OR

Control Load Side

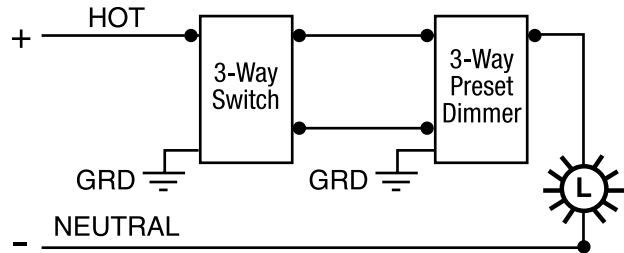

4-Way Wiring

Control Line Side

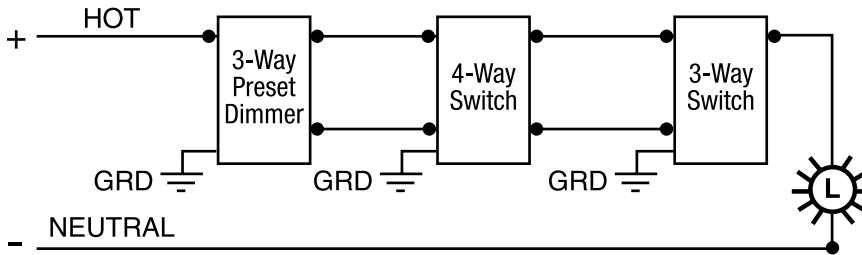

OR

Control Load Side

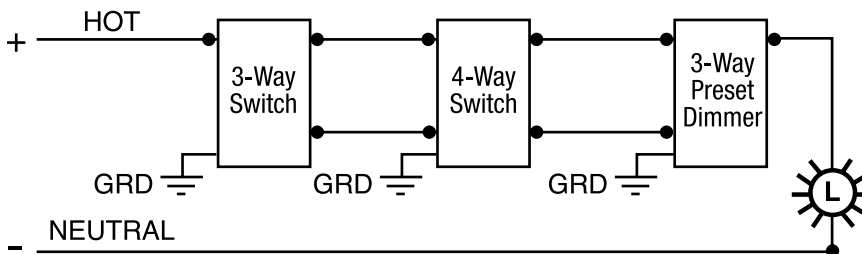

For Dual Timer Cat.# 97352
Wiring Diagrams,
see Page K-25.

TECHNICAL SPECIFICATIONS

PlugTail® Specification Grade Switches 15 & 20A, 120/277VAC

Typical Specifications

Manufacturer's Identification: Pass & Seymour® PT15AC1
 Description: PlugTail® Specification Grade Switches
 Rating: 15 & 20A, 120/277VAC
 3rd Party Compliance: cULus Listed, File Number LR17446, Standard CSA-C22.2 No. 111,
 General Use Snap Switches. Federal Specification WS896. Conforms to NEMA WD-1 and WD-6.

CATALOG NUMBER	COLOR	DESCRIPTION/RATING	CATALOG NUMBER	COLOR	DESCRIPTION/RATING
<input type="checkbox"/> PT15AC1W	White	15A 120/277VAC, Single Pole	<input type="checkbox"/> PT20AC3I	Ivory	20A 120/277VAC, 3-Way
<input type="checkbox"/> PT15AC1	Brown	15A 120/277VAC, Single Pole	<input type="checkbox"/> PT20AC3W	White	20A 120/277VAC, 3-Way
<input type="checkbox"/> PT15AC1BK	Black	15A 120/277VAC, Single Pole	<input type="checkbox"/> PT20AC3	Brown	20A 120/277VAC, 3-Way
<input type="checkbox"/> PT15AC1RED	Red	15A 120/277VAC, Single Pole	<input type="checkbox"/> PT20AC3BK	Black	20A 120/277VAC, 3-Way
<input type="checkbox"/> PT15AC1LA	Lt. Almond	15A 120/277VAC, Single Pole	<input type="checkbox"/> PT20AC3GRY	Gray	20A 120/277VAC, 3-Way
<input type="checkbox"/> PT15AC3W	White	15A 120/277VAC, 3-Way	<input type="checkbox"/> PT20AC3RED	Red	20A 120/277VAC, 3-Way
<input type="checkbox"/> PT15AC3	Brown	15A 120/277VAC, 3-Way	<input type="checkbox"/> PT20AC3LA	Lt. Almond	20A 120/277VAC, 3-Way
<input type="checkbox"/> PT15AC3BK	Black	15A 120/277VAC, 3-Way	ILLUMINATED*		
<input type="checkbox"/> PT15AC3RED	Red	15A 120/277VAC, 3-Way	<input type="checkbox"/> PT15AC1WSL	White	15A 120/277VAC, Single Pole
<input type="checkbox"/> PT15AC3LA	Lt. Almond	15A 120/277VAC, 3-Way	<input type="checkbox"/> PT15AC3WSL	White	15A 120/277VAC, 3-Way
<input type="checkbox"/> PT20AC1I	Ivory	20A 120/277VAC, Single Pole	<input type="checkbox"/> PT20AC1CSL	Clear	20A 120/277VAC, Single Pole
<input type="checkbox"/> PT20AC1W	White	20A 120/277VAC, Single Pole	<input type="checkbox"/> PT20AC1ISL	Ivory	20A 120/277VAC, Single Pole
<input type="checkbox"/> PT20AC1	Brown	20A 120/277VAC, Single Pole	<input type="checkbox"/> PT20AC1WSL	White	20A 120/277VAC, Single Pole
<input type="checkbox"/> PT20AC1BK	Black	20A 120/277VAC, Single Pole	<input type="checkbox"/> PT20AC3CSL	Clear	20A 120/277VAC, 3-Way
<input type="checkbox"/> PT20AC1GRY	Gray	20A 120/277VAC, Single Pole	<input type="checkbox"/> PT20AC3ISL	Ivory	20A 120/277VAC, 3-Way
<input type="checkbox"/> PT20AC1RED	Red	20A 120/277VAC, Single Pole	<input type="checkbox"/> PT20AC3WSL	White	20A 120/277VAC, 3-Way
<input type="checkbox"/> PT20AC1LA	Lt. Almond	20A 120/277VAC, Single Pole			

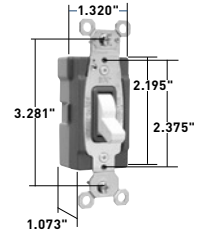

PT20AC1W



Performance

Electrical

Dielectric Withstand Voltage: 1500V minimum
 Maximum Working Voltage: 277VAC, 347VAC
 Overload: Minimum 4.8 times rated current for 100 cycles
 Temperature Rise: 30°C maximum at rated current
 Maximum Continuous Current: 277VAC 20A
 Endurance: 50,000 cycles minimum, resistive, inductive, tungsten filament lamp load (Fed Spec)

Mechanical

PlugTail Connector Identification: #12 AWG, THHN, copper conductor, 6" leads, stripped, solid or stranded, for use with PlugTail Switches only
 Product Identification: Ratings are a permanent part of the device

Environmental

Flammability: UL94 V2
 Operating Temperature: Maximum continuous +60°C, minimum -40°C without impact

PlugTail Switch Materials

Front Body:	Nylon	Spring Arm:	Brass
Back Body:	Glass-Reinforced Nylon	Bumper:	Rubber
Toggle:	Thermoplastic Polycarbonate	Spring:	Zinc-Plated Steel
Contacts:	Silver Cadmium Oxide	Auto Ground Clip:	Nickel-Plated Brass
Mounting Strap:	Nickel-Plated Brass	Illuminating Lamp:*	Neon

PlugTail Connector Materials

Housing:	Polycarbonate	Contacts:	Brass
----------	---------------	-----------	-------

*For Illuminated versions. May not be compatible with some fluorescent lighting loads.



PTS6STR3 PTS6STR4

Project
Location/Type

TECHNICAL SPECIFICATIONS

Industrial Extra Heavy-Duty Specification Grade Switches

Back & Side Wire 15, 20 & 30A, 120/277VAC

Typical Specifications

Manufacturer's Identification: Pass & Seymour® PS15AC1
 Description: Industrial EHD Specification Grade Switch, Back & Side Wire
 Rating: 15A, 120/277VAC
 3rd Party Compliance: UL Listed File Number E140597; Standard UL20, General Use Snap Switches.
 Federal Specification WS896, CSA Certified, File Number LR17446, Standard CSA-C22.2 No. 111,
 General Use Snap Switches. Conforms to NEMA WD-1 and WD-6.

CATALOG NUMBER	COLOR	DESCRIPTION/RATING	CATALOG NUMBER	COLOR	DESCRIPTION/RATING
PS15AC1I	Ivory	15A 120/277VAC, Single Pole	PS20AC2I	Ivory	20A 120/277VAC, Double Pole
PS15AC1W	White	15A 120/277VAC, Single Pole	PS20AC2W	White	20A 120/277VAC, Double Pole
PS15AC1	Brown	15A 120/277VAC, Single Pole	PS20AC2	Brown	20A 120/277VAC, Double Pole
PS15AC1GRY	Gray	15A 120/277VAC, Single Pole	PS20AC2GRY	Gray	20A 120/277VAC, Double Pole
PS15AC1LA	Lt. Almond	15A 120/277VAC, Single Pole	PS20AC2BK	Black	20A 120/277VAC, Double Pole
PS15AC2I	Ivory	15A 120/277VAC, Double Pole	PS20AC2RED	Red	20A 120/277VAC, Double Pole
PS15AC2W	White	15A 120/277VAC, Double Pole	PS20AC2LA	Lt. Almond	20A 120/277VAC, Double Pole
PS15AC2	Brown	15A 120/277VAC, Double Pole	PS20AC3I	Ivory	20A 120/277VAC, 3-Way
PS15AC2GRY	Gray	15A 120/277VAC, Double Pole	PS20AC3W	White	20A 120/277VAC, 3-Way
PS15AC2LA	Lt. Al.	15A 120/277VAC, Double Pole	PS20AC3	Brown	20A 120/277VAC, 3-Way
PS15AC3I	Ivory	15A 120/277VAC, 3-Way	PS20AC3GRY	Gray	20A 120/277VAC, 3-Way
PS15AC3W	White	15A 120/277VAC, 3-Way	PS20AC3BK	Black	20A 120/277VAC, 3-Way
PS15AC3	Brown	15A 120/277VAC, 3-Way	PS20AC3RED	Red	20A 120/277VAC, 3-Way
PS15AC3GRY	Gray	15A 120/277VAC, 3-Way	PS20AC3LA	Lt. Almond	20A 120/277VAC, 3-Way
PS15AC3LA	Lt. Almond	15A 120/277VAC, 3-Way	PS20AC3GN	Green	20A 120/277VAC, 3-Way
PS15AC4I	Ivory	15A 120/277VAC, 4-Way	PS20AC4I	Ivory	20A 120/277VAC, 4-Way
PS15AC4W	White	15A 120/277VAC, 4-Way	PS20AC4W	White	20A 120/277VAC, 4-Way
PS15AC4	Brown	15A 120/277VAC, 4-Way	PS20AC4	Brown	20A 120/277VAC, 4-Way
PS15AC4GRY	Gray	15A 120/277VAC, 4-Way	PS20AC4GRY	Gray	20A 120/277VAC, 4-Way
PS15AC4LA	Lt. Almond	15A 120/277VAC, 4-Way	PS20AC4BK	Black	20A 120/277VAC, 4-Way
PS20AC1I	Ivory	20A 120/277VAC, Single Pole	PS20AC4RED	Red	20A 120/277VAC, 4-Way
PS20AC1W	White	20A 120/277VAC, Single Pole	PS20AC4LA	Lt. Almond	20A 120/277VAC, 4-Way
PS20AC1	Brown	20A 120/277VAC, Single Pole	PS30AC1I	Ivory	30A 120/277VAC, Single Pole
PS20AC1GRY	Gray	20A 120/277VAC, Single Pole	PS30AC1W	White	30A 120/277VAC, Single Pole
PS20AC1BK	Black	20A 120/277VAC, Single Pole	PS30AC1	Brown	30A 120/277VAC, Single Pole
PS20AC1RED	Red	20A 120/277VAC, Single Pole	PS30AC2I	Ivory	30A 120/277VAC, Double Pole
PS20AC1LA	Lt. Almond	20A 120/277VAC, Single Pole	PS30AC2W	White	30A 120/277VAC, Double Pole
PS20AC1GN	Green	20A 120/277VAC, Single Pole	PS30AC2	Brown	30A 120/277VAC, Double Pole
			PS30AC3I	Ivory	30A 120/277VAC, 3-Way
			PS30AC3	Brown	30A 120/277VAC, 3-Way

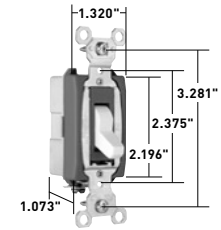

15 & 20 Amp*
 *30AC series is 1.437" wide

Performance

Electrical

Dielectric Withstand Voltage: 1500V Minimum
 Maximum Working Voltage: 277VAC
 Overload: Minimum 4.8 times rated current for 100 cycles
 Temperature Rise: 30°C maximum at rated current
 Maximum Continuous Current: 277VAC
 Endurance: 50,000 cycles minimum, resistive, inductive, tungsten filament lamp load (Fed Spec)

Mechanical

Terminal Accommodations: #14 AWG – #10 AWG stranded (when back-wired) or solid copper conductors

Environmental

Flammability: UL94 V2
 Operating Temperature: Maximum continuous +115°C, minimum -40°C

Materials

Back Body:	Glass-Reinforced Nylon	Contacts:	Silver Cadmium Oxide
Front Body:	Nylon	Spring Arm:	Brass
Toggle:	Thermoplastic Polycarbonate	Bumper:	Rubber
Terminals:	Brass	Spring:	Zinc-Plated Steel
Terminal Screws:	Tri-Drive Brass	Ground Terminal:	Brass
Mounting Strap:	Nickel-Plated Steel	Ground Screw:	Tri-Drive Zinc-Plated Steel
Pressure Plate:	Brass	Auto-Ground Clip:	Nickel-Plated Brass

Project
Location/Type

TECHNICAL SPECIFICATIONS

Industrial Extra Heavy-Duty & Extra Heavy-Duty Specification Grade Switches

15, 20 & 30A, 120, 277 & 120/277VAC

Typical Specifications

Manufacturer's Identification: Pass & Seymour® PS15AC1ISL

Description: Industrial EHD Specification Grade Switch, Back & Side Wire

Rating: 15A, 120/277VAC

3rd Party Compliance: UL Listed, File Number E140597, Standard UL20, General Use Snap Switches. Federal Specification WS896, CSA Certified, File Number LR17446, Standard CSA-C22.2 No. 111, General Use Snap Switches. Conforms to NEMA WD-1 and WD-6.

CATALOG NUMBER	COLOR	DESCRIPTION/RATING	CATALOG NUMBER	COLOR	DESCRIPTION/RATING
□ PS15AC1CSL	Clear	15A 120/277VAC, Single Pole	□ PS20AC1LAL	Lt. Almond	20A 120/277VAC, Single Pole
□ PS15AC1ISL	Ivory	15A 120/277VAC, Single Pole	□ PS20AC1KSL	—	20A 120/277VAC, Single Pole
□ PS15AC1WSL	White	15A 120/277VAC, Single Pole	□ PS20AC2CPL	Clear	20A 120/277VAC, Double Pole
□ PS15AC1CPL	Clear	15A 120VAC, Single Pole	□ PS20AC2RPL	Red	20A 120/277VAC, Double Pole
□ PS15AC1RPL	Red	15A 120VAC, Single Pole	□ PS20AC2IL	Ivory	20A 120/277VAC, Double Pole
□ PS15AC3CSL	Clear	15A 120/277VAC, 3-Way	□ PS20AC2WL	White	20A 120/277VAC, Double Pole
□ PS15AC3ISL	Ivory	15A 120/277VAC, 3-Way	□ PS20AC2L	Gray	20A 120/277VAC, Double Pole
□ PS15AC3WSL	White	15A 120/277VAC, 3-Way	□ PS20AC2LAL	Lt. Almond	20A 120/277VAC, Double Pole
□ PS15AC3CPL	Clear	15A 120VAC, 3-Way	□ PS20AC2KL	—	20A 120/277VAC, Double Pole
□ PS15AC3RPL	Red	15A 120VAC, 3-Way	□ PS20AC3CSL	Clear	20A 120/277VAC, Double Pole
□ PS20AC1CSL	Clear	20A 120/277VAC, Single Pole	□ PS20AC3ISL	Ivory	20A 120/277VAC, Double Pole
□ PS20AC1ISL	Ivory	20A 120/277VAC, Single Pole	□ PS20AC3WSL	White	20A 120/277VAC, Double Pole
□ PS20AC1WSL	White	20A 120/277VAC, Single Pole	□ PS20AC3LASL	Lt. Almond	20A 120/277VAC, 3-Way
□ PS20AC1LASL	Lt. Almond	20A 120/277VAC, Single Pole	□ PS20AC3CPL	Clear	20A 120VAC, 3-Way
□ PS20AC1CPL	Clear	20A 120VAC, Single Pole	□ PS20AC3RPL	Red	20A 120VAC, 3-Way
□ PS20AC1CPL7	Clear	20A 277VAC, Single Pole	□ PS20AC3RPL7	Red	20A 277VAC, 3-Way
□ PS20AC1RPL	Red	20A 120VAC, Single Pole	□ PS20AC3IL	Ivory	20A 120/277VAC, 3-Way
□ PS20AC1RPL7	Red	20A 277VAC, Single Pole	□ PS20AC3WL	White	20A 120/277VAC, 3-Way
□ PS20AC1IL	Ivory	20A 120/277VAC, Single Pole	□ PS20AC3L	Gray	20A 120/277VAC, 3-Way
□ PS20AC1WL	White	20A 120/277VAC, Single Pole	□ PS20AC3REDL	Red	20A 120/277VAC, 3-Way
□ PS20AC1L	Gray	20A 120/277VAC, Single Pole	□ PS20AC3LAL	Lt. Almond	20A 120/277VAC, 3-Way
□ PS20AC1REDL	Red	20A 120/277VAC, Single Pole	□ PS20AC3KL	—	20A 120/277VAC, 3-Way
			□ PS20AC4IL	Ivory	20A 120/277VAC, 4-Way
			□ PS20AC4WL	White	20A 120/277VAC, 4-Way
			□ PS20AC4REDL	Red	20A 120/277VAC, 4-Way
			□ PS20AC4LAL	Lt. Almond	20A 120/277VAC, 4-Way
			□ PS20AC4KL	—	20A 120/277VAC, 4-Way
			□ PS30AC1RPL	Red	30A 120VAC, Single Pole
			□ PS30AC2RPL	Red	30A 120/ 277VAC, Double Pole
			□ PS30AC3RPL	Red	30A 120VAC, 3-Way

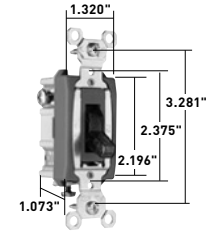

15 & 20 Amp Lighted & Pilot Lighted

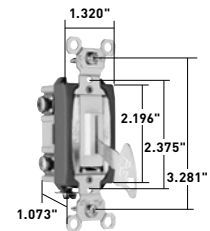

Locking
30AC series
is 1.437" wide

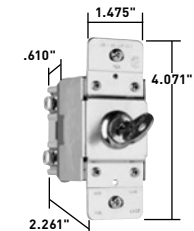

Security Switch

Performance

Electrical

- Dielectric Withstand Voltage: 1500V Minimum
- Maximum Working Voltage: 277VAC
- Overload: Minimum 4.8 times rated current for 100 cycles
- Temperature Rise: 30°C maximum at rated current
- Maximum Continuous Current: 277VAC
- Endurance: 50,000 cycles minimum, resistive, inductive, tungsten filament lamp load (Fed Spec)

Mechanical

Terminal Accommodations: #14 AWG - #10 AWG stranded (when back-wired) or solid copper conductors

Environmental

- Flammability: UL94 V2
- Operating Temperature: Maximum continuous +115°C, minimum -40°C

Materials

- Back Body: Glass-Reinforced Nylon
- Front Body: Nylon
- Toggle: Thermoplastic Polycarbonate
- Key Slot:** Thermoplastic Polycarbonate
- Terminals: Brass
- Terminal Screws: Tri-Drive Brass
- Strap: Nickel-Plated Steel
- Pressure Plate: Brass
- Contacts: Silver Cadmium Oxide
- Spring Arm: Brass
- Bumper: Rubber
- Spring: Zinc-Plated Steel
- Ground Terminal:† Brass
- Ground Screw: Tri-Drive Zinc-Plated Steel
- Auto-Ground Clip:† Nickel-Plated Brass
- Illuminating Lamp:* Neon
- Lock Housing: Stainless Steel

*For Lighted versions. May not be compatible with some fluorescent lighting loads. **For Locking versions.

†For Security versions Ground Terminal is Zinc-Plated Steel. No Auto-Ground Clip on Security Switches.

Project
Location/Type

TECHNICAL SPECIFICATIONS

TECHNICAL SPECIFICATIONS

Hard Use Specification Grade Switches Back & Side Wire 15 & 20A, 120/277VAC

Typical Specifications

Manufacturer's Identification: Pass & Seymour® CSB15AC1
 Description: Hard Use Specification Grade Switch, Back & Side Wire
 Rating: 15A, 120/277VAC
 3rd Party Compliance: UL Listed, File Number E140597, Standard UL20, General Use Snap Switches.
 Federal Specification WS896, CSA Certified, File Number LR17446, Standard CSA-C22.2 No. 111,
 General Use Snap Switches. Conforms to NEMA WD-1 and WD-6.

CATALOG NUMBER	COLOR	DESCRIPTION/RATING	CATALOG NUMBER	COLOR	DESCRIPTION/RATING
<input type="checkbox"/> CSB15AC1I	Ivory	15A 120/277VAC, Single Pole	<input type="checkbox"/> CSB15AC3I	Ivory	15A 120/277VAC, 3-Way
<input type="checkbox"/> CSB15AC1W	White	15A 120/277VAC, Single Pole	<input type="checkbox"/> CSB15AC3W	White	15A 120/277VAC, 3-Way
<input type="checkbox"/> CSB15AC1	Brown	15A 120/277VAC, Single Pole	<input type="checkbox"/> CSB15AC3	Brown	15A 120/277VAC, 3-Way
<input type="checkbox"/> CSB15AC1GRY	Gray	15A 120/277VAC, Single Pole	<input type="checkbox"/> CSB15AC3GRY	Gray	15A 120/277VAC, 3-Way
<input type="checkbox"/> CSB15AC1LA	Lt. Almond	15A 120/277VAC, Single Pole	<input type="checkbox"/> CSB15AC3LA	Lt. Almond	15A 120/277VAC, 3-Way
<input type="checkbox"/> CSB20AC1I	Ivory	20A 120/277VAC, Single Pole	<input type="checkbox"/> CSB20AC3I	Ivory	20A 120/277VAC, 3-Way
<input type="checkbox"/> CSB20AC1W	White	20A 120/277VAC, Single Pole	<input type="checkbox"/> CSB20AC3W	White	20A 120/277VAC, 3-Way
<input type="checkbox"/> CSB20AC1	Brown	20A 120/277VAC, Single Pole	<input type="checkbox"/> CSB20AC3	Brown	20A 120/277VAC, 3-Way
<input type="checkbox"/> CSB20AC1GRY	Gray	20A 120/277VAC, Single Pole	<input type="checkbox"/> CSB20AC3GRY	Gray	20A 120/277VAC, 3-Way
<input type="checkbox"/> CSB20AC1BK	Black	20A 120/277VAC, Single Pole	<input type="checkbox"/> CSB20AC3BK	Black	20A 120/277VAC, 3-Way
<input type="checkbox"/> CSB20AC1LA	Lt. Almond	20A 120/277VAC, Single Pole	<input type="checkbox"/> CSB20AC3LA	Lt. Almond	20A 120/277VAC, 3-Way
<input type="checkbox"/> CSB15AC2I	Ivory	15A 120/277VAC, Double Pole	<input type="checkbox"/> CSB15AC4I	Ivory	15A 120/277VAC, 4-Way
<input type="checkbox"/> CSB15AC2W	White	15A 120/277VAC, Double Pole	<input type="checkbox"/> CSB15AC4W	White	15A 120/277VAC, 4-Way
<input type="checkbox"/> CSB15AC2	Brown	15A 120/277VAC, Double Pole	<input type="checkbox"/> CSB15AC4	Brown	15A 120/277VAC, 4-Way
<input type="checkbox"/> CSB15AC2GRY	Gray	15A 120/277VAC, Double Pole	<input type="checkbox"/> CSB15AC4GRY	Gray	15A 120/277VAC, 4-Way
<input type="checkbox"/> CSB15AC2LA	Lt. Almond	15A 120/277VAC, Double Pole	<input type="checkbox"/> CSB15AC4LA	Lt. Almond	15A 120/277VAC, 4-Way
<input type="checkbox"/> CSB20AC2I	Ivory	20A 120/277VAC, Double Pole	<input type="checkbox"/> CSB20AC4I	Ivory	20A 120/277VAC, 4-Way
<input type="checkbox"/> CSB20AC2W	White	20A 120/277VAC, Double Pole	<input type="checkbox"/> CSB20AC4W	White	20A 120/277VAC, 4-Way
<input type="checkbox"/> CSB20AC2	Brown	20A 120/277VAC, Double Pole	<input type="checkbox"/> CSB20AC4	Brown	20A 120/277VAC, 4-Way
<input type="checkbox"/> CSB20AC2GRY	Gray	20A 120/277VAC, Double Pole	<input type="checkbox"/> CSB20AC4GRY	Gray	20A 120/277VAC, 4-Way
<input type="checkbox"/> CSB20AC2LA	Lt. Almond	20A 120/277VAC, Double Pole	<input type="checkbox"/> CSB20AC4LA	Lt. Almond	20A 120/277VAC, 4-Way

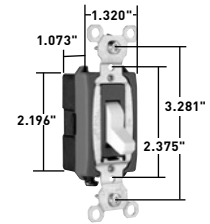

15 & 20 Amp

Performance

Electrical

Dielectric Withstand Voltage: 1500V Minimum
 Maximum Working Voltage: 277VAC
 Overload: Minimum 4.8 times rated current for 100 cycles
 Temperature Rise: 30°C maximum at rated current
 Maximum Continuous Current: 277VAC
 Endurance: 50,000 cycles minimum, resistive, inductive, tungsten filament lamp load (Fed Spec)

Mechanical

Terminal Accommodations: #14 AWG – #10 AWG stranded (when back-wired) or solid copper conductors

Environmental

Flammability: UL94 V2
 Operating Temperature: Maximum continuous +115°C, minimum -40°C

Materials

Back Body:	Glass-Reinforced Nylon	Contacts:	Silver Cadmium Oxide
Front Body:	Nylon	Spring Arm:	Brass
Toggle:	Thermoplastic Polycarbonate	Bumper:	Rubber
Terminals:	Brass	Spring:	Zinc-Plated Steel
Terminal Screws:	Tri-Drive Brass	Ground Terminal:	Brass
Mounting Strap:	Nickel-Plated Steel	Ground Screw:	Tri-Drive Zinc-Plated Steel
Pressure Plate:	Brass		

Project
Location/Type

TECHNICAL SPECIFICATIONS

TECHNICAL SPECIFICATIONS

Commercial Specification Grade Switches Side Wire 15 & 20A, 120/277VAC

Typical Specifications

Manufacturer's Identification: Pass & Seymour® CS15AC1

Description: Commercial Specification Grade Switch, Side Wire

Rating: 15A, 120/277VAC

3rd Party Compliance: UL Listed, File Number E140597, Standard UL20, General Use Snap Switches.

Federal Specification WS896, CSA Certified, File Number LR17446, Standard CSA-C22.2 No. 111,

General Use Snap Switches. Conforms to NEMA WD-1 and WD-6.

CATALOG NUMBER	COLOR	DESCRIPTION/RATING	CATALOG NUMBER	COLOR	DESCRIPTION/RATING
<input type="checkbox"/> CS15AC1I	Ivory	15A 120/277VAC, Single Pole	<input type="checkbox"/> CS15AC3I	Ivory	15A 120/277VAC, 3-Way
<input type="checkbox"/> CS15AC1W	White	15A 120/277VAC, Single Pole	<input type="checkbox"/> CS15AC3W	White	15A 120/277VAC, 3-Way
<input type="checkbox"/> CS15AC1	Brown	15A 120/277VAC, Single Pole	<input type="checkbox"/> CS15AC3	Brown	15A 120/277VAC, 3-Way
<input type="checkbox"/> CS15AC1GRY	Gray	15A 120/277VAC, Single Pole	<input type="checkbox"/> CS15AC3GRY	Gray	15A 120/277VAC, 3-Way
<input type="checkbox"/> CS15AC1BK	Black	15A 120/277VAC, Single Pole	<input type="checkbox"/> CS15AC3BK	Black	15A 120/277VAC, 3-Way
<input type="checkbox"/> CS15AC1LA	Lt. Almond	15A 120/277VAC, Single Pole	<input type="checkbox"/> CS15AC3LA	Lt. Almond	15A 120/277VAC, 3-Way
<input type="checkbox"/> CS20AC1I	Ivory	20A 120/277VAC, Single Pole	<input type="checkbox"/> CS20AC3I	Ivory	20A 120/277VAC, 3-Way
<input type="checkbox"/> CS20AC1W	White	20A 120/277VAC, Single Pole	<input type="checkbox"/> CS20AC3W	White	20A 120/277VAC, 3-Way
<input type="checkbox"/> CS20AC1	Brown	20A 120/277VAC, Single Pole	<input type="checkbox"/> CS20AC3	Brown	20A 120/277VAC, 3-Way
<input type="checkbox"/> CS20AC1GRY	Gray	20A 120/277VAC, Single Pole	<input type="checkbox"/> CS20AC3GRY	Gray	20A 120/277VAC, 3-Way
<input type="checkbox"/> CS20AC1LA	Lt. Almond	20A 120/277VAC, Single Pole	<input type="checkbox"/> CS20AC3LA	Lt. Almond	20A 120/277VAC, 3-Way

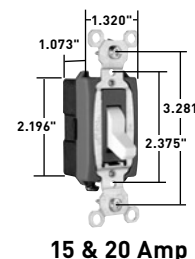

Performance

Electrical

Dielectric Withstand Voltage: 1500V Minimum

Maximum Working Voltage: 277VAC

Overload: Minimum 4.8 times rated current for 100 cycles

Temperature Rise: 30°C maximum at rated current

Maximum Continuous Current: 277VAC

Endurance: 50,000 cycles minimum, resistive, inductive, tungsten filament lamp load (Fed Spec)

Mechanical

Terminal Accommodations: #14 AWG – #10 AWG copper conductors

Environmental

Flammability: UL94 V2

Operating Temperature: Maximum continuous +115°C, minimum -40°C

Materials

Back Body: Glass-Reinforced Nylon

Front Body: Nylon

Toggle: Thermoplastic Polycarbonate

Terminals: Brass

Terminal Screws: Tri-Drive Brass

Mounting Strap: Nickel-Plated Steel

Contacts: Silver Cadmium Oxide

Spring Arm: Brass

Bumper: Rubber

Spring: Zinc-Plated Steel

Ground Terminal: Brass

Ground Screw: Tri-Drive Zinc-Plated Steel

For double pole and 4-Way switches refer to CSB version on Page U-26.

Project
Location/Type

TECHNICAL SPECIFICATIONS

Manual Controller Switches 30A, 600VAC, 1Ø & 3Ø

Typical Specifications

Manufacturer's Identification: Pass & Seymour® 7802

Description: Manual Controller, Double Pole, Single Phase

Rating: 30A, 600VAC max.

3rd Party Compliance: UL Listed, File Number E31169, Standard UL508, Industrial Control Equipment; CSA Certified, File Number LR17949, Standard CSA-C22.23, No. 14, Industrial Control Equipment. Conforms to NEMA WD-1 and WD-6.

CATALOG NUMBER	RATING		DESCRIPTION
□ 7802MD	General Use	2 120	Double Pole, Single Phase AC
	30 600Max.	3 240	Manual Motor Starting Switch
		7.5 480	(No overload protection)
		10 600	See Footnote 1
□ 7812PMD	Same as 7802MD		7812P, See Footnote 1
□ 7812EX	Same as 7802MD		7802MD in a NEMA 7 & 9 Enclosure for Hazardous Locations Class I – Groups C, D; Class II – Groups E, F, G
□ 7832MD	Same as 7802MD		7832, See Footnote 1
□ 7803MD	General Use	3 120	Three Phase, Three Pole AC
	30 600Max.	7.5 240	Manual Motor Starting Switch
		10 480	(No overload protection)
		20 600	See Footnote 1
□ 7813PMD	Same as 7803		7813P, See Footnote 1
□ 7813EX	Same as 7803		7803MD in a NEMA 7 & 9 Enclosure for Hazardous Locations Class I – Groups C, D; Class II – Groups E, F, G
□ 7833MD	Same as 7803		7803, See Footnote 1

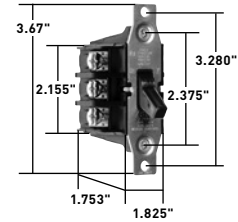

**7802MD
7803MD**

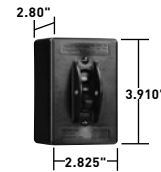

**7812PMD
7813PMD**

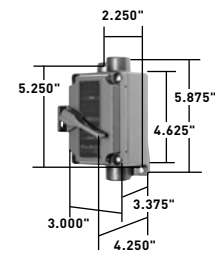

**7812EX
7813EX**

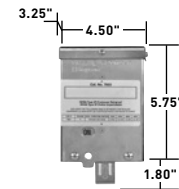

**7832MD
7833MD**

All Industrial Control Equipment is suitable for use in a circuit capable of deliverable not more than 5,000 rms amperes at 600VAC maximum or equivalent.

Footnote 1. Suitable as Motor Disconnect – 10KA @ 600VAC, 30A max. Class J Fuse

Performance

Electrical

- Dielectric Withstand Voltage: 2000V Minimum
- Maximum Working Voltage: 600VAC
- Overload: 50 cycles, 132 Amps/600VAC .5 PF
- Temperature Rise: 50°C maximum
- Maximum Continuous Current: 30A
- Endurance: 1000 Cycles, 44Amp/600VAC 0.5 PF
5000 Cycles, 30Amp/600VAC 0.75 PF

Mechanical

Terminal Accommodations: #14 AWG – #10 AWG copper or copper-clad wire

Environmental

- Flammability: UL94 V2
- Operating Temperature: Maximum continuous +75°C, minimum -40°C

Materials

- Back Body: Nylon
- Front Body: Nylon
- Carrier: Nylon
- Toggle: Nylon
- Contract Arm: Brass
- Terminals: Brass
- Terminal Screws: Brass
- Leaf Springs: Stainless Steel
- Coil Springs: Zinc-Plated Steel
- Strap: Zinc-Plated Steel
- Rivets: Brass
- Contacts: Silver Cadmium Oxide

TECHNICAL SPECIFICATIONS

Project
Location/Type

TECHNICAL SPECIFICATIONS

Manual Controller Switches 40A, 600VAC, 1Ø & 3Ø

Typical Specifications

Manufacturer's Identification: Pass & Seymour® 7842MD

Description: Manual Controller, Double Pole, Single Phase

Rating: 40A, 600VAC max.

3rd Party Compliance: UL Listed, File Number E31169, Standard UL508, Industrial Control Equipment;

CSA Certified, File Number LR17949, Standard CSA-C22.23, No. 14, Industrial Control Equipment.

Conforms to NEMA WD-1 and WD-6.

CATALOG NUMBER	RATING	DESCRIPTION
□ 7842MD	General Use 2 120	Double Pole, Single Phase AC
	40 600Max. 5 240	Manual Motor Starting Switch (No overload protection)
	10 480	See Footnote 2
	15 600	See Footnote 2
□ 7843MD	General Use 3 120	Three Phase, Three Pole AC
	40 600Max. 7.5 240	Manual Motor Starting Switch (No overload protection)
	15 480	See Footnote 2
	20 600	See Footnote 2
□ 7801P		Handle Locking Guard has opening for padlock to secure control in either ON or OFF position.
□ 7806P		NEMA 1 Black Nylon Enclosure has baked-on gray enamel finish with 1/2" and 3/4" knockouts at each end.
□ 7830		NEMA 3R Aluminum Enclosure

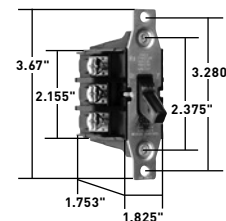

7842MD
7843MD

All Industrial Control Equipment is suitable for use in a circuit capable of deliverable not more than 5,000 rms amperes at 600VAC maximum or equivalent.

Footnote: 2. Suitable as Motor Disconnect – 10KA @ 600VAC, 60A max. Class J Fuse or 100A max. Ferraz Shawmut HSJ Fuse

Performance

Electrical

Dielectric Withstand Voltage: 2000V Minimum

Maximum Working Voltage: 600VAC

Overload: 50 cycles, 132 Amps/600VAC .5 PF

Temperature Rise: 50°C maximum

Maximum Continuous Current: 30A

Endurance: 1000 Cycles, 44Amp/600VAC 0.5 PF
5000 Cycles, 30Amp/600VAC 0.75 PF

Mechanical

Terminal Accommodations: #14 AWG – #10 AWG copper or copper-clad wire

Environmental

Flammability: UL94 V2

Operating Temperature: Maximum continuous +75°C, minimum -40°C

Materials

Back Body: Nylon

Front Body: Nylon

Carrier: Nylon

Toggle: Nylon

Contract Arm: Brass

Terminals: Brass

Terminal Screws: Brass

Leaf Springs: Stainless Steel

Coil Springs: Zinc-Plated Steel

Strap: Zinc-Plated Steel

Rivets: Brass

Contacts: Silver Cadmium Oxide

Project

Location/Type

TECHNICAL SPECIFICATIONS

PlugTail® Specification Grade Decorator Switches 15 & 20A, 120/277VAC

Typical Specifications

Manufacturer's Identification: Pass & Seymour® PT2601
 Description: PlugTail® Specification Grade Decorator Switches
 Rating: 15 & 20A, 120/277VAC
 3rd Party Compliance: cULus Listed, File Number E140597, Standard CSA-C22.2 No. 111, General Use Snap Switches. Federal Specification WS896. Conforms to NEMA WD-1 and WD-6.

CATALOG NUMBER	COLOR	DESCRIPTION/RATING	CATALOG NUMBER	COLOR	DESCRIPTION/RATING
<input type="checkbox"/> PT2601I	Ivory	15A 120/277VAC, Single Pole	<input type="checkbox"/> PT2621RED	Red	20A 120/277VAC, Single Pole
<input type="checkbox"/> PT2601W	White	15A 120/277VAC, Single Pole	<input type="checkbox"/> PT2621BK	Black	20A 120/277VAC, Single Pole
<input type="checkbox"/> PT2601	Brown	15A 120/277VAC, Single Pole	<input type="checkbox"/> PT2621LA	Lt. Almond	20A 120/277VAC, Single Pole
<input type="checkbox"/> PT2601GRY	Gray	15A 120/277VAC, Single Pole	<input type="checkbox"/> PT2623I	Ivory	20A 120/277VAC, 3-Way
<input type="checkbox"/> PT2601BK	Black	15A 120/277VAC, Single Pole	<input type="checkbox"/> PT2623W	White	20A 120/277VAC, 3-Way
<input type="checkbox"/> PT2601LA	Lt. Almond	15A 120/277VAC, Single Pole	<input type="checkbox"/> PT2623	Brown	20A 120/277VAC, 3-Way
<input type="checkbox"/> PT2603I	Ivory	15A 120/277VAC, 3-Way	<input type="checkbox"/> PT2623GRY	Gray	20A 120/277VAC, 3-Way
<input type="checkbox"/> PT2603W	White	15A 120/277VAC, 3-Way	<input type="checkbox"/> PT2623RED	Red	20A 120/277VAC, 3-Way
<input type="checkbox"/> PT2603	Brown	15A 120/277VAC, 3-Way	<input type="checkbox"/> PT2623BK	Black	20A 120/277VAC, 3-Way
<input type="checkbox"/> PT2603GRY	Gray	15A 120/277VAC, 3-Way	<input type="checkbox"/> PT2623LA	Lt. Almond	20A 120/277VAC, 3-Way
<input type="checkbox"/> PT2603BK	Black	15A 120/277VAC, 3-Way	ILLUMINATED*		
<input type="checkbox"/> PT2603LA	Lt. Almond	15A 120/277VAC, 3-Way	<input type="checkbox"/> PT2625I	Ivory	20A 120/277VAC, Single Pole
<input type="checkbox"/> PT2621I	Ivory	20A 120/277VAC, Single Pole	<input type="checkbox"/> PT2625W	White	20A 120/277VAC, Single Pole
<input type="checkbox"/> PT2621W	White	20A 120/277VAC, Single Pole	<input type="checkbox"/> PT2626I	Ivory	20A 120/277VAC, 3-Way
<input type="checkbox"/> PT2621	Brown	20A 120/277VAC, Single Pole	<input type="checkbox"/> PT2626W	White	20A 120/277VAC, 3-Way
<input type="checkbox"/> PT2621GRY	Gray	20A 120/277VAC, Single Pole			

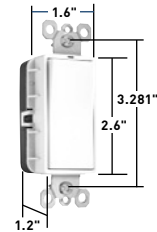

PT2626W



Performance

Electrical

Dielectric Withstand Voltage: 1500V Minimum
 Maximum Working Voltage: 277VAC, 347VAC
 Overload: Minimum 4.8 times rated current for 100 cycles
 Temperature Rise: 30°C maximum at rated current
 Maximum Continuous Current: 20A
 Endurance: 50,000 cycles minimum, resistive, inductive, tungsten filament lamp load (Fed Spec)

Mechanical

PlugTail Connector Identification: #12 AWG, THHN, copper conductor, 6" leads, stripped, solid or stranded, for use with PlugTail Switches only
 Product Identification: Ratings are a permanent part of the device

Environmental

Flammability: UL94 V2
 Operating Temperature: Maximum continuous +60°C, minimum -40°C without impact

Materials

Front Body: Polycarbonate
 Back Body: Polycarbonate
 Paddle: Thermoplastic Polycarbonate
 Contacts: Silver Cadmium Oxide
 Mounting Strap: Steel
 Spring Arm: Brass
 Springs: Zinc-Plated Steel
 Auto Ground Clip: Steel
 Illuminating Lamp:* LED

PlugTail Connector Materials

Housing: Polycarbonate
 Contacts: Brass

*For Illuminated versions. May not be compatible with some fluorescent lighting loads.

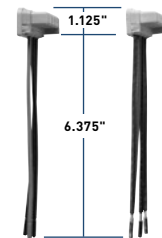

**PTS6STR3
PTS6STR4**

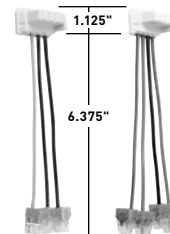

**PTS6STR3BP
PTS6STR4BP**

Project
Location/Type

TECHNICAL SPECIFICATIONS

Specification Grade Decorator Switches 15 & 20A, 120/277VAC; 20A, 120VAC

Typical Specifications

Manufacturer's Identification: Pass & Seymour® 2601

Description: Specification Grade Decorator Switch, Back & Side Wire

Rating: 15A, 120/277VAC

3rd Party Compliance: UL Listed, File Number E140597, Standard UL20, General Use Snap Switches, CSA Certified, File Number LR17446, Standard CSA-C22.2 No. 111, General Use Snap Switches.

Conforms to NEMA WD-1 and WD-6.

CATALOG NUMBER	COLOR	DESCRIPTION/RATING	CATALOG NUMBER	COLOR	DESCRIPTION/RATING
☐ 2601I	Ivory	15A 120/277VAC, Single Pole	☐ 2623RED	Red	20A 120/277VAC, 3-Way
☐ 2601W	White	15A 120/277VAC, Single Pole	☐ 2623LA	Lt. Almond	20A 120/277VAC, 3-Way
☐ 2601GRY	Gray	15A 120/277VAC, Single Pole	☐ 2604I	Ivory	15A 120/277VAC, 4-Way
☐ 2601BK	Black	15A 120/277VAC, Single Pole	☐ 2604W	White	15A 120/277VAC, 4-Way
☐ 2601LA	Lt. Almond	15A 120/277VAC, Single Pole	☐ 2604LA	Lt. Al.	15A 120/277VAC, 4-Way
☐ 2621I	Ivory	20A 120/277VAC, Single Pole	☐ 2624I	Ivory	20A 120/277VAC, 4-Way
☐ 2621W	White	20A 120/277VAC, Single Pole	☐ 2624W	White	20A 120/277VAC, 4-Way
☐ 2621	Brown	20A 120/277VAC, Single Pole	☐ 2624	Brown	20A 120/277VAC, 4-Way
☐ 2621GRY	Gray	20A 120/277VAC, Single Pole	☐ 2624GRY	Gray	20A 120/277VAC, 4-Way
☐ 2621BK	Black	20A 120/277VAC, Single Pole	☐ 2624BK	Black	20A 120/277VAC, 4-Way
☐ 2621RED	Red	20A 120/277VAC, Single Pole	☐ 2624RED	Red	20A 120/277VAC, 4-Way
☐ 2621LA	Lt. Almond	20A 120/277VAC, Single Pole	☐ 2624LA	Lt. Almond	20A 120/277VAC, 4-Way
☐ 2622I	Ivory	20A 120/277VAC, Double Pole	ILLUMINATED*		
☐ 2622W	White	20A 120/277VAC, Double Pole	☐ 2625I	Ivory	20A 120VAC, Single Pole
☐ 2622	Brown	20A 120/277VAC, Double Pole	☐ 2625W	White	20A 120VAC, Single Pole
☐ 2622GRY	Gray	20A 120/277VAC, Double Pole	☐ 2625	Brown	20A 120VAC, Single Pole
☐ 2622BK	Black	20A 120/277VAC, Double Pole	☐ 2625LA	Lt. Almond	20A 120VAC, Single Pole
☐ 2622LA	Lt. Almond	20A 120/277VAC, Double Pole	☐ 2626I	Ivory	20A 120VAC, 3-Way
☐ 2603I	Ivory	15A 120/277VAC, 3-Way	☐ 2626W	White	20A 120VAC, 3-Way
☐ 2603W	White	15A 120/277VAC, 3-Way	☐ 2626LA	Lt. Almond	20A 120VAC, 3-Way
☐ 2603GRY	Gray	15A 120/277VAC, 3-Way	☐ 2628I	Ivory	20A 120VAC, 4-Way
☐ 2603BK	Black	15A 120/277VAC, 3-Way	☐ 2628W	White	20A 120VAC, 4-Way
☐ 2603LA	Lt. Almond	15A 120/277VAC, 3-Way	☐ 2628LA	Lt. Almond	20A 120VAC, 4-Way
☐ 2623I	Ivory	20A 120/277VAC, 3-Way	PILOT LIGHTED		
☐ 2623W	White	20A 120/277VAC, 3-Way	☐ 2629I	Ivory	20A 120VAC, Single Pole
☐ 2623	Brown	20A 120/277VAC, 3-Way	☐ 2629W	White	20A 120VAC, Single Pole
☐ 2623GRY	Gray	20A 120/277VAC, 3-Way	☐ 2629LA	Lt. Almond	20A 120VAC, Single Pole
☐ 2623BK	Black	20A 120/277VAC, 3-Way	☐ 2629BK	Black	20A 120VAC, Single Pole

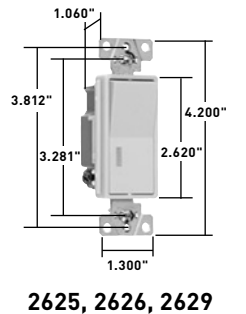
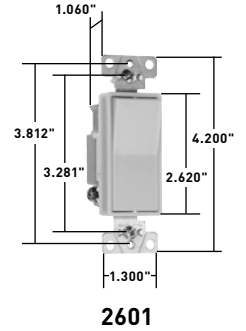

Performance

Electrical

Dielectric Withstand Voltage: 1500V Minimum

Maximum Working Voltage: 277VAC

Overload: Minimum 4.8 times rated current for 100 cycles

Temperature Rise: 30°C maximum at rated current

Maximum Continuous Current: 277VAC

Endurance: 50,000 cycles minimum, resistive, inductive, tungsten filament lamp load

Mechanical

Terminal Accommodation: #14 AWG – #10 AWG

Environmental

Flammability: UL94 V2

Operating Temperature: Maximum continuous +115°C, minimum -40°C

Materials

Back Body: Polycarbonate

Frame: Polycarbonate

Paddle: Thermoplastic

Terminals: Brass

Terminal Screws: Tri-Drive Brass-Plated Steel

Strap: Steel

Pressure Plate: Steel

Contacts: Silver Cadmium Oxide

Spring Arm: Brass

Bumper: Rubber

Spring: Zinc-Plated Steel

Ground Terminal: Brass

Ground Screw: Tri-Drive Zinc-Plated Steel

Illuminating Lamp*: Neon

Lens*: Polycarbonate

*For Illuminated versions. May not be compatible with some fluorescent lighting loads.

Project
Location/Type

TECHNICAL SPECIFICATIONS

Specification Grade Combination & Momentary & Maintained Contact Switches

15A, 120VAC; 20A, 277VAC

Typical Specifications

Manufacturer's Identification: Pass & Seymour® PS81120, PS811120, TM811DTMO & TM811DTMA

Rating: PS81120 & PS811120: 20A, 277VAC. TM811DTMO & TM811DTMA: 15A, 120VAC

3rd Party Compliance: PS81120, PS811120, TM811DTMA: cULus Listed, File Number E140597, Standard UL20,

General Use Snap Switches. TM811DTMO: cULus Listed, File Number E31169, UL508, Industrial Control.

Conforms to NEMA WD-1 and WD-6.

Performance

Electrical

Maximum Amperage per Circuit: PS81120 and PS811120 = 20A

Maximum Amperage per Device: PS81120 = 30A, PS811120 = 35A

Dielectric Withstand Voltage: 1500V Minimum

Maximum Working Voltage: PS81120 and PS811120 = 277VAC
TM811DTMO and TM811DTMA = 120VAC

Overload: Minimum 4.8 times rated current for 100 cycles

Temperature Rise: 30°C maximum at rated current

Maximum Continuous Current: PS81120 and PS811120 = 277VAC

TM811DTMO and TM811DTMA = 120VAC

Mechanical

Terminal Accommodation: #14 AWG – #10 AWG

Product Identification: Amperage, Voltage, 3rd Party Compliance

Environmental

Flammability: UL94 V2

Operating Temperature: Maximum continuous +115°C, minimum -40°C

Materials

Back Body: Polycarbonate

Frame: Polycarbonate

Paddle: Thermoplastic

Terminals: Brass

Terminal Screws: Tri-Drive Brass-Plated Steel

Strap: Steel

Pressure Plate: Steel

Contacts: Silver Cadmium Oxide

Spring: Zinc-Plated Steel

Ground Terminal: Brass

Ground Screw: Tri-Drive Zinc-Plated Steel

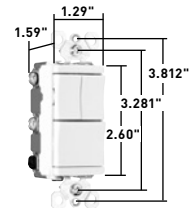

15 & 20 Amp

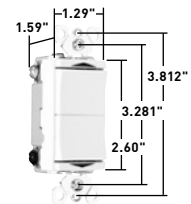

Momentary Contact

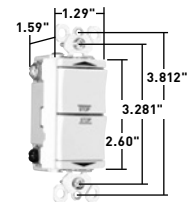

Maintained Contact

Project
Location/Type

TECHNICAL SPECIFICATIONS

Fed Spec Grade USB Chargers with Tamper-Resistant Receptacles

2 Pole, 3 Wire Grounding 15 & 20A, 125V & 120V

Typical Specifications

Manufacturer's Identification: Pass & Seymour® TR5261USB

Description: Fed Spec Grade USB Chargers with Tamper-Resistant Receptacles

Type: 2 Pole, 3 Wire Grounding

Rating: 15V, 125VAC

Configuration: NEMA 5-15R

3rd Party Compliance: cULus Listed, ETL Tested US and Canada. Complies with test requirements UL 498, UL 1310.

Fed Spec WC596, CSA C22.2 No. 42, CSA C22.2 No. 223.

CATALOG NUMBER	COLOR	RATING	NEMA CONFIG. NO.	CATALOG NUMBER	COLOR	RATING	NEMA CONFIG. NO.
<input type="checkbox"/> TR5261USBI	Ivory	15A 125VAC	5-15R	<input type="checkbox"/> TR5262USBI	Ivory	15A 125VAC	5-15R
<input type="checkbox"/> TR5261USBW	White	15A 125VAC	5-15R	<input type="checkbox"/> TR5262USBW	White	15A 125VAC	5-15R
<input type="checkbox"/> TR5261USB	Brown	15A 125VAC	5-15R	<input type="checkbox"/> TR5262USB	Brown	15A 125VAC	5-15R
<input type="checkbox"/> TR5261USBGRY	Gray	15A 125VAC	5-15R	<input type="checkbox"/> TR5262USBGRY	Gray	15A 125VAC	5-15R
<input type="checkbox"/> TR5261USBBK	Black	15A 125VAC	5-15R	<input type="checkbox"/> TR5262USBBK	Black	15A 125VAC	5-15R
<input type="checkbox"/> TR5261USBLA	Light Almond	15A 125VAC	5-15R	<input type="checkbox"/> TR5262USBLA	Light Almond	15A 125VAC	5-15R
<input type="checkbox"/> TR5261USBNI	Nickel	15A 125VAC	5-15R	<input type="checkbox"/> TR5262USBNI	Nickel	15A 125VAC	5-15R
<input type="checkbox"/> TR5361USBI	Ivory	20A 125VAC	5-20R	<input type="checkbox"/> TR5362USBI	Ivory	20A 125VAC	5-20R
<input type="checkbox"/> TR5361USBW	White	20A 125VAC	5-20R	<input type="checkbox"/> TR5362USBW	White	20A 125VAC	5-20R
<input type="checkbox"/> TR5361USB	Brown	20A 125VAC	5-20R	<input type="checkbox"/> TR5362USB	Brown	20A 125VAC	5-20R
<input type="checkbox"/> TR5361USBGRY	Gray	20A 125VAC	5-20R	<input type="checkbox"/> TR5362USBGRY	Gray	20A 125VAC	5-20R
<input type="checkbox"/> TR5361USBBK	Black	20A 125VAC	5-20R	<input type="checkbox"/> TR5362USBBK	Black	20A 125VAC	5-20R
<input type="checkbox"/> TR5361USBLA	Light Almond	20A 125VAC	5-20R	<input type="checkbox"/> TR5362USBLA	Light Almond	20A 125VAC	5-20R
<input type="checkbox"/> TR5361USBNI	Nickel	20A 125VAC	5-20R	<input type="checkbox"/> TR5362USBNI	Nickel	20A 125VAC	5-20R

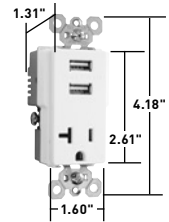

TR5261USBW

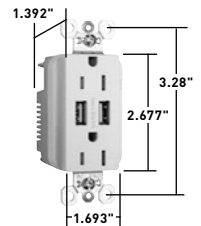

TR5262USBLA

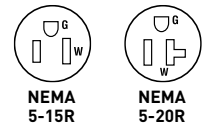

Performance

Electrical

Dielectric Withstand Voltage: Withstands 1500V Minimum

Maximum Working Voltage: 125V

Current Interrupting: Certified for current interrupting at full-rated current (receptacle only)

Temperature Rise: Maximum 30°C after 50 cycles at full-rated current after 50 cycles of overload are 150% of rated current with direct current

Mechanical

Terminal Identification: Terminal Identification in accordance with UL498 (Brass, White, Green)

Terminal Accommodation: #14 AWG – #10 AWG copper conductor only

Product Identification: Ratings are permanent part of the device

Environmental

Flammability: UL94 V2

Operating Temperature: Maximum continuous +60°C, minimum -40°C without impact

Materials

Face: Polycarbonate

Body: Nylon

Contacts: CDA 260 Brass

Mounting Strap: .049" Zinc-Plated Steel

Terminal Screws: Tri-Drive Zinc-Plated Steel with either clear or black chromate for color identification

Ground Screw: Tri-Drive Green with green chromate

Auto-Ground Clip: Stainless Steel

Mounting Screws: Tri-Drive Steel

Warranty: 1 year

Project
Location/Type

TECHNICAL SPECIFICATIONS

Hospital Grade USB Chargers with Tamper-Resistant Receptacles

2 Pole, 3 Wire Grounding 15 & 20A, 125V & 120V

Typical Specifications

Manufacturer's Identification: Pass & Seymour® TR8200HUSB

Description: Hospital Grade USB Chargers with Tamper-Resistant Receptacles

Type: 2 Pole, 3 Wire Grounding

Rating: 15A, 125VAC

Configuration: NEMA 5-15R

3rd Party Compliance: cULus Listed, ETL Tested US and Canada. Complies with test requirements UL 498, UL 1310.

Fed Spec WC596, CSA C22.2 No. 42, CSA C22.2 No. 223.

CATALOG NUMBER	COLOR	RATING	NEMA CONFIG. NO.
<input type="checkbox"/> TR8200HUSBI	Ivory	15A 125VAC	5-15R
<input type="checkbox"/> TR8200HUSBW	White	15A 125VAC	5-15R
<input type="checkbox"/> TR8200HUSB	Brown	15A 125VAC	5-15R
<input type="checkbox"/> TR8200HUSBGRY	Gray	15A 125VAC	5-15R
<input type="checkbox"/> TR8200HUSBBK	Black	15A 125VAC	5-15R
<input type="checkbox"/> TR8200HUSBRED	Red	15A 125VAC	5-15R
<input type="checkbox"/> TR8300HUSBI	Ivory	20A 125VAC	5-20R
<input type="checkbox"/> TR8300HUSBW	White	20A 125VAC	5-20R
<input type="checkbox"/> TR8300HUSB	Brown	20A 125VAC	5-20R
<input type="checkbox"/> TR8300HUSBGRY	Gray	20A 125VAC	5-20R
<input type="checkbox"/> TR8300HUSBBK	Black	20A 125VAC	5-20R
<input type="checkbox"/> TR8300HUSBRED	Red	20A 125VAC	5-20R
<input type="checkbox"/> TR8300HUSBLA	Light Almond	20A 125VAC	5-20R

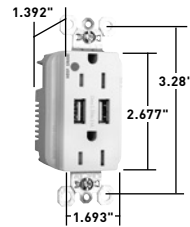

TR8200HUSBLA

Performance

Electrical

Dielectric Withstand Voltage: Withstands 1500V Minimum

Maximum Working Voltage: 125V

Current Interrupting: Certified for current interrupting at full-rated current (receptacle only)

Temperature Rise: Maximum 30°C after 50 cycles at full-rated current after 50 cycles of overload are 150% of rated current with direct current

Mechanical

Terminal Identification: Terminal Identification in accordance with UL498 (Brass, White, Green)

Terminal Accommodation: #14 AWG – #10 AWG copper conductor only

Product Identification: Ratings are permanent part of the device

Environmental

Flammability: UL94 V2

Operating Temperature: Maximum continuous +60°C, minimum -40°C without impact

Materials

Face: Polycarbonate

Body: Nylon

Contacts: CDA 260 Brass

Mounting Strap: .049" Zinc-Plated Steel

Terminal Screws: Tri-Drive Zinc-Plated Steel with either Clear or Black Chromate for color identification

Ground Screw: Tri-Drive Green with Green Chromate

Auto-Ground Clip: Stainless Steel

Mounting Screws: Tri-Drive Steel

Warranty: 1 year

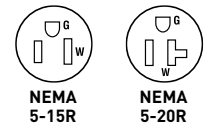

Project
Location/Type



TECHNICAL SPECIFICATIONS

PlugTail® Extra Heavy-Duty Specification Grade Receptacles

2 Pole, 3 Wire Grounding 15 & 20A, 125V

Typical Specifications

Manufacturer's Identification: Pass & Seymour® PT5262A & PTTR62
 Description: PlugTail® Straight Blade Duplex Receptacle & Tamper-Resistant Duplex Receptacle – Extra Heavy-Duty
 Type: 2 Pole, 3 Wire Grounding
 Rating: 15A, 125V
 Configuration: NEMA 5-15R
 3rd Party Compliance: cULus Listed, File Number E140596, Standard UL498, Federal Specification WC596.
 Conforms to NEMA WD-1 and WD-6.

CATALOG NUMBER	COLOR	RATING	NEMA CONFIG. NO.	CATALOG NUMBER	COLOR	RATING	NEMA CONFIG. NO.
<input type="checkbox"/> PT5262AI	Ivory	15A 125V	5-15R	<input type="checkbox"/> PTTR62I	Ivory	15A 125V	5-15R
<input type="checkbox"/> PT5262AW	White	15A 125V	5-15R	<input type="checkbox"/> PTTR62W	White	15A 125V	5-15R
<input type="checkbox"/> PT5262A	Brown	15A 125V	5-15R	<input type="checkbox"/> PTTR63I	Ivory	20A 125V	5-20R
<input type="checkbox"/> PT5262AGRY	Gray	15A 125V	5-15R	<input type="checkbox"/> PTTR63W	White	20A 125V	5-20R
<input type="checkbox"/> PT5262ABK	Black	15A 125V	5-15R	<input type="checkbox"/> PTTR63	Brown	20A 125V	5-20R
<input type="checkbox"/> PT5262ALA	Lt. Almond	15A 125V	5-15R	<input type="checkbox"/> PTTR63GRY	Gray	20A 125V	5-20R
<input type="checkbox"/> PT5362AI	Ivory	20A 125V	5-20R	<input type="checkbox"/> PTTR63BK	Black	20A 125V	5-20R
<input type="checkbox"/> PT5362AW	White	20A 125V	5-20R	<input type="checkbox"/> PTTR63LA	Lt. Almond	20A 125V	5-20R
<input type="checkbox"/> PT5362A	Brown	20A 125V	5-20R				
<input type="checkbox"/> PT5362AGRY	Gray	20A 125V	5-20R				
<input type="checkbox"/> PT5362ABK	Black	20A 125V	5-20R				
<input type="checkbox"/> PT5362ARED	Red	20A 125V	5-20R				
<input type="checkbox"/> PT5362ALA	Lt. Almond	20A 125V	5-20R				

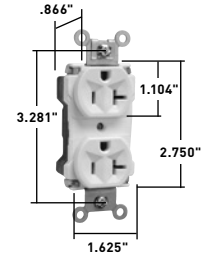

PT5362AW

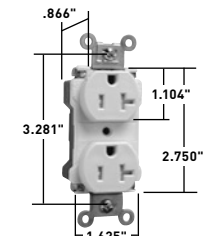

PTTR63W

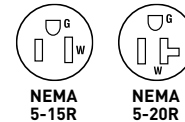

Performance

Electrical

Dielectric Voltage: Withstands 2000V minimum
 Maximum Working Voltage: 125V
 Current Interrupting: Certified for current interrupting at full-rated current (receptacle only)
 Temperature Rise: Maximum 30°C temperature rise at full-rated current after 50 cycles of overload at 150% of rated current with direct current

Mechanical

PlugTail Connectors Identification: #12 AWG, THHN, copper conductor, 6" leads, stripped, solid or stranded, for use with PlugTail Receptacles only
 Product Identification: Ratings are a permanent part of the device

Environmental

Flammability: UL94 V2
 Operating Temperature: Maximum continuous +60°C, minimum -40°C without impact

PlugTail Receptacle Materials

Face:	Nylon	Integral Ground System:	.036 260 Brass
Back Body:	Nylon	Assembly Drive Screw:	Zinc-Plated Steel
Line Contacts:	.036 688 Brass	Auto-Ground Clip:	Brass
Mounting Strap:	.050 260 Brass	Mounting Screws:	Tri-Drive Steel
Tamper Shutter*:	Thermoplastic		

PlugTail Connector Materials

Housing:	Polycarbonate	Contacts:	036 688 Brass
----------	---------------	-----------	---------------

*For Tamper-Resistant version.
 Consult Straight Blade Section B for complete compliance listing.

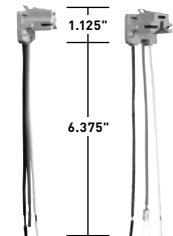

PTR6STR
PTR6STRG



PTR6STRBP

Project
Location/Type

TECHNICAL SPECIFICATIONS



TECHNICAL SPECIFICATIONS

PlugTail® Extra Heavy-Duty Hospital Grade Receptacles

2 Pole, 3 Wire Grounding 15 & 20A, 125V

Typical Specifications

Manufacturer's Identification: Pass & Seymour® PT8200 & PTTR62H

Description: PlugTail® Straight Blade Duplex Receptacle & Tamper-Resistant Duplex Receptacle – Extra Heavy-Duty

Type: 2 Pole, 3 Wire Grounding

Rating: 15A, 125V

Configuration: NEMA 5-15R

3rd Party Compliance: cULus Listed, File Number E140596, Standard UL498, Federal Specification WC596, Hospital Grade. Conforms to NEMA WD-1 and WD-6.

CATALOG NUMBER	COLOR	RATING	NEMA CONFIG. NO.	CATALOG NUMBER	COLOR	RATING	NEMA CONFIG. NO.
<input type="checkbox"/> PT8200I	Ivory	15A 125V	5-15R	<input type="checkbox"/> PTTR62HI	Ivory	15A 125V	5-15R
<input type="checkbox"/> PT8200W	White	15A 125V	5-15R	<input type="checkbox"/> PTTR62HW	White	15A 125V	5-15R
<input type="checkbox"/> PT8200GRY	Gray	15A 125V	5-15R	<input type="checkbox"/> PTTR62HBK	Black	15A 125V	5-15R
<input type="checkbox"/> PT8200BK	Black	15A 125V	5-15R	<input type="checkbox"/> PTTR62HRED	Red	15A 125V	5-15R
<input type="checkbox"/> PT8200RED	Red	15A 125V	5-15R	<input type="checkbox"/> PTTR63HI	Ivory	20A 125V	5-20R
<input type="checkbox"/> PT8200LA	Lt. Almond	15A 125V	5-15R	<input type="checkbox"/> PTTR63HW	White	20A 125V	5-20R
<input type="checkbox"/> PT8200BL	Blue	15A 125V	5-15R	<input type="checkbox"/> PTTR63H	Brown	20A 125V	5-20R
<input type="checkbox"/> PT8300I	Ivory	20A 125V	5-20R	<input type="checkbox"/> PTTR63HGRY	Gray	20A 125V	5-20R
<input type="checkbox"/> PT8300W	White	20A 125V	5-20R	<input type="checkbox"/> PTTR63HBK	Black	20A 125V	5-20R
<input type="checkbox"/> PT8300	Brown	20A 125V	5-20R	<input type="checkbox"/> PTTR63HRED	Red	20A 125V	5-20R
<input type="checkbox"/> PT8300GRY	Gray	20A 125V	5-20R	<input type="checkbox"/> PTTR63HLA	Lt. Almond	20A 125V	5-20R
<input type="checkbox"/> PT8300BK	Black	20A 125V	5-20R				
<input type="checkbox"/> PT8300RED	Red	20A 125V	5-20R				
<input type="checkbox"/> PT8300LA	Lt. Almond	20A 125V	5-20R				
<input type="checkbox"/> PT8300BL	Blue	20A 125V	5-20R				

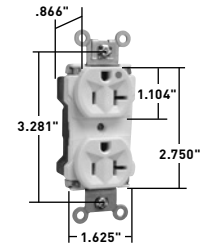

PT8300W

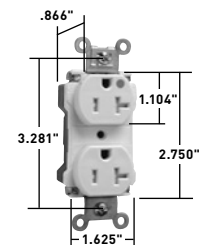

PTTR63HW

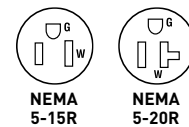

Performance

Electrical

Dielectric Voltage: Withstands 2000V minimum
 Maximum Working Voltage: 125V
 Current Interrupting: Certified for current interrupting at full-rated current (receptacle only)
 Temperature Rise: Maximum 30°C temperature rise at full-rated current after 50 cycles of overload at 150% of rated current with direct current

Mechanical

PlugTail Connectors Identification: #12 AWG, THHN, copper conductor, 6" leads, stripped, solid or stranded, for use with PlugTail Receptacles only
 Product Identification: Ratings are a permanent part of the device

Environmental

Flammability: UL94 V2
 Operating Temperature: Maximum continuous +60°C, minimum -40°C without impact

PlugTail Receptacle Materials

Face:	Nylon	Integral Ground System:	.036 260 Brass
Back Body:	Nylon	Assembly Drive Screw:	Zinc-Plated Steel
Line Contacts:	.036 688 Brass	Auto-Ground Clip:	Brass
Mounting Strap:	.050 260 Brass	Mounting Screws:	Tri-Drive Steel
Tamper Shutter*:	Thermoplastic		

PlugTail Connector Materials

Housing:	Polycarbonate	Contacts:	.036 688 Brass
----------	---------------	-----------	----------------

*For Tamper-Resistant version.
 Consult Straight Blade Section B and Hospital Grade Section E for complete compliance listing.

TECHNICAL SPECIFICATIONS

Project
Location/Type



TECHNICAL SPECIFICATIONS

PlugTail® Extra Heavy-Duty Hospital Grade Illuminated Receptacles

2 Pole, 3 Wire Grounding 15 & 20A, 125V

Typical Specifications

Manufacturer's Identification: Pass & Seymour® PT8200IL
 Description: PlugTail® Straight Blade Illuminated Duplex Receptacle – Extra Heavy-Duty Hospital Grade
 Type: 2 Pole, 3 Wire Grounding
 Rating: 15A, 125V
 Configuration: NEMA 5-15R
 3rd Party Compliance: cULus Listed, File Number E140596, Standard UL498, Federal Specification WC596, Hospital Grade. Conforms to NEMA WD-1 and WD-6.

CATALOG NUMBER	COLOR	RATING	NEMA CONFIG. NO.	CATALOG NUMBER	COLOR	RATING	NEMA CONFIG. NO.
<input type="checkbox"/> PT8200ILI	Ivory	15A 125V	5-15R	<input type="checkbox"/> PT8300ILI	Ivory	20A 125V	5-20R
<input type="checkbox"/> PT8200ILW	White	15A 125V	5-15R	<input type="checkbox"/> PT8300ILW	White	20A 125V	5-20R
<input type="checkbox"/> PT8200ILGRY	Gray	15A 125V	5-15R	<input type="checkbox"/> PT8300IL	Brown	20A 125V	5-20R
<input type="checkbox"/> PT8200ILBK	Black	15A 125V	5-15R	<input type="checkbox"/> PT8300ILGRY	Gray	20A 125V	5-20R
<input type="checkbox"/> PT8200ILRED	Red	15A 125V	5-15R	<input type="checkbox"/> PT8300ILRED	Red	20A 125V	5-20R
<input type="checkbox"/> PT8200ILLA	Lt. Almond	15A 125V	5-15R	<input type="checkbox"/> PT8300ILLA	Lt. Almond	20A 125V	5-20R

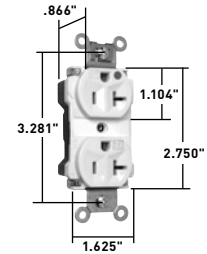

PT8300ILLA

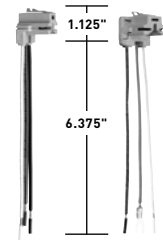

PTR6STR, PTR6STRG



PTR6STRBP

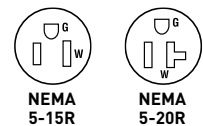

Performance

Electrical

Dielectric Voltage: Withstands 2000V minimum
 Maximum Working Voltage: 125V
 Current Interrupting: Certified for current interrupting at full-rated current (receptacle only)
 Temperature Rise: Maximum 30°C temperature rise at full-rated current after 50 cycles of overload at 150% of rated current with direct current

Mechanical

PlugTail Connectors Identification: #12 AWG, THHN, copper conductor, 6" leads, stripped, solid or stranded, for use with PlugTail Receptacles only
 Product Identification: Ratings are a permanent part of the device

Environmental

Flammability: UL94 V2
 Operating Temperature: Maximum continuous +60°C, minimum -40°C without impact

PlugTail Receptacle Materials

Face:	Nylon	Assembly Drive Screw:	Zinc-Plated Steel
Back Body:	Nylon	Auto-Ground Clip:	Brass
Line Contacts:	.036 688 Brass	Mounting Screws:	Tri-Drive Steel
Mounting Strap:	.050 260 Brass	LED:	8-9 Years
Integral Ground System:	.036 260 Brass		

PlugTail Connector Materials

Housing: Polycarbonate Contacts: .036 688 Brass

Consult Straight Blade Section B and Hospital Grade Section E for complete compliance listing.

Project
Location/Type

TECHNICAL SPECIFICATIONS

Extra Heavy-Duty Hospital Grade Receptacles

Back & Side Wire 2 Pole, 3 Wire Grounding 15 & 20A, 125 & 250V

Typical Specifications

Manufacturer's Identification: Pass & Seymour® 8200
 Description: Straight Blade Duplex Receptacle – Extra Heavy-Duty Hospital Grade
 Type: 2 Pole, 3 Wire Grounding
 Rating: 15A, 125V
 Configuration: NEMA 5-15R
 3rd Party Compliance: UL Listed, File Number E140596, Standard UL498, Federal Specification WC596, Hospital Grade. CSA Certified, File Number LR16063, Standard CSA-C22.2, No. 42. Conforms to NEMA WD-1 and WD-6.

CATALOG NUMBER	COLOR	RATING	NEMA CONFIG. NO.	CATALOG NUMBER	COLOR	RATING	NEMA CONFIG. NO.
8200I	Ivory	15A 125V	5-15R	8300BK	Black	20A 125V	5-20R
8200W	White	15A 125V	5-15R	8300RED	Red	20A 125V	5-20R
8200	Brown	15A 125V	5-15R	8300LA	Lt. Almond	20A 125V	5-20R
8200GRY	Gray	15A 125V	5-15R	8300ILI	Ivory	20A 125V	5-20R
8200BK	Black	15A 125V	5-15R	8300ILW	White	20A 125V	5-20R
8200RED	Red	15A 125V	5-15R	8300ILGRY	Gray	20A 125V	5-20R
8200LA	Lt. Almond	15A 125V	5-15R	8300ILRED	Red	20A 125V	5-20R
8200ILI	Ivory	15A 125V	5-15R	8300ILLA	Lt. Almond	20A 125V	5-20R
8200ILW	White	15A 125V	5-15R	8800I	Ivory	20A 250V	6-20R
8200ILRED	Red	15A 125V	5-15R	8800W	White	20A 250V	6-20R
8300I	Ivory	20A 125V	5-20R	8800	Brown	20A 250V	6-20R
8300W	White	20A 125V	5-20R	8800GRY	Gray	20A 250V	6-20R
8300	Brown	20A 125V	5-20R	8800BK	Black	20A 250V	6-20R
8300GRY	Gray	20A 125V	5-20R	8800LA	Lt. Almond	20A 250V	6-20R
				8800RED	Red	20A 250V	6-20R

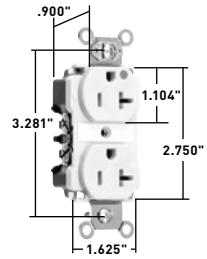

15 & 20 Amp

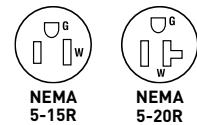

Performance

Electrical

Dielectric Voltage: Withstands 2000V minimum
 Maximum Working Voltage: 250V
 Current Interrupting: Certified for current interrupting at full-rated current
 Temperature Rise: Maximum 30°C temperature rise at full-rated current after 50 cycles of overload at 150% of rated current with direct current

Mechanical

Terminal Identification: Terminals identified in accordance with UL498 (Brass, White, Green)
 Terminal Accommodation: #14 – #10 AWG copper conductor only
 Product Identification: Ratings are a permanent part of the device

Environmental

Flammability: UL94 V2 and UL94-5 VA
 Operating Temperature: Maximum continuous +60°C, minimum -40°C without impact

Materials

Face:	Nylon	Terminal Screws:	#10 Tri-Drive Brass (Neutral = Nickel-Plated Steel)
Back Body:	Nylon	Ground Screw:	#10 Hex Tri-Drive Brass
Line Contacts:	.040 688 Nickel-Plated Brass	Assembly Drive Screw:	Zinc-Plated Steel
Mounting Strap:	.050 688 Brass	Auto-Ground Clip:	Brass
Ground Contacts:	Strap with Integral Ground	Mounting Screws:	Tri-Drive Steel
Pressure Plate:	.031 260 Nickel-Plated Brass	Illuminating Lamp*:	Neon

*For LED Illuminated Face version.
 Consult Straight Blade Section B and Hospital Grade Section E for complete compliance listing.

TECHNICAL SPECIFICATIONS

Project
Location/Type



TECHNICAL SPECIFICATIONS

Extra Heavy-Duty Hospital Grade MRI Receptacles

Back & Side Wire 2 Pole, 3 Wire Grounding 15 & 20A, 125V

Typical Specifications

Manufacturer's Identification: Pass & Seymour® 8200MRI

Description: Straight Blade Duplex Receptacle – Extra Heavy-Duty Hospital Grade MRI

Type: 2 Pole, 3 Wire Grounding

Rating: 15A, 125V

Configuration: NEMA 5-15R

3rd Party Compliance: UL Listed, File Number E140596, Standard UL498, Federal Specification

WC596, Hospital Grade. CSA Certified, File Number LR16063, Standard CSA-C22.2 No. 42. Conforms to NEMA WD-1 and WD-6.

CATALOG NUMBER	COLOR	RATING	NEMA CONFIG. NO.	CATALOG NUMBER	COLOR	RATING	NEMA CONFIG. NO.
<input type="checkbox"/> 8200WMRI	White	15A 125V	5-15R	<input type="checkbox"/> 8300IMRI	Ivory	20A 125V	5-20R
<input type="checkbox"/> 8200REDMRI	Red	15A 125V	5-15R	<input type="checkbox"/> 8300WMRI	White	20A 125V	5-20R
<input type="checkbox"/> 8200LAMRI	Lt. Almond	15A 125V	5-15R	<input type="checkbox"/> 8300GRYMRI	Gray	20A 125V	5-20R
				<input type="checkbox"/> 8300REDMRI	Red	20A 125V	5-20R
				<input type="checkbox"/> 8300LAMRI	Lt. Almond	20A 125V	5-20R

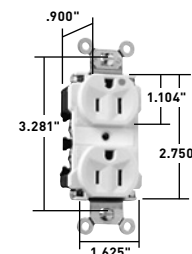

15 & 20 Amp

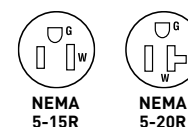

Performance

Electrical

Dielectric Voltage: Withstands 2000V minimum

Maximum Working Voltage: 250V

Current Interrupting: Certified for current interrupting at full-rated current

Temperature Rise: Maximum 30°C temperature rise at full-rated current after 50 cycles of overload at 150% of rated current with direct current

Mechanical

Terminal Identification: Terminal Identification in accordance with UL498 (Brass, White, Green)

Terminal Accommodation: #14 – #10 AWG copper conductor only

Product Identification: Ratings are a permanent part of the device

Environmental

Flammability: UL94 V2

Operating Temperature: Maximum continuous +60°C, minimum -40°C without impact

Materials

Face: Nylon

Back Body: Nylon

Line Contacts: .036 688 Brass

Mounting Strap: .050 688 Brass

Ground Contacts: Strap with Integral Ground

Pressure Plate: .031 260 Brass

Terminal Screws: #10 Tri-Drive Brass

Ground Screw: #10 Hex Tri-Drive Brass

Auto-Ground Clip: Brass

Mounting Screws: Slotted Brass

Consult Straight Blade Section B and Hospital Grade Section E for complete compliance listing.

Project
Location/Type

TECHNICAL SPECIFICATIONS

Industrial Extra Heavy-Duty Specification Grade Receptacles

Back & Side Wire 2 Pole, 3 Wire Grounding 15 & 20A, 125 & 250V

Typical Specifications

Manufacturer's Identification: Pass & Seymour® 5262A
 Description: Straight Blade Duplex Receptacle – Industrial Extra Heavy-Duty Specification Grade
 Type: 2 Pole, 3 Wire Grounding
 Rating: 15A, 125V
 Configuration: NEMA 5-15R
 3rd Party Compliance: UL Listed, File Number E140596, Standard UL498, Federal Specification WC596. CSA Certified, File Number LR16063, Standard CSA-C22.2 No. 42. Conforms to NEMA WD-1 and WD-6.

CATALOG NUMBER	COLOR	RATING	NEMA CONFIG. NO.	CATALOG NUMBER	COLOR	RATING	NEMA CONFIG. NO.
<input type="checkbox"/> 5262AI	Ivory	15A 125V	5-15R	<input type="checkbox"/> 5362AI	Ivory	20A 125V	5-20R
<input type="checkbox"/> 5262AW	White	15A 125V	5-15R	<input type="checkbox"/> 5362AW	White	20A 125V	5-20R
<input type="checkbox"/> 5262A	Brown	15A 125V	5-15R	<input type="checkbox"/> 5362A	Brown	20A 125V	5-20R
<input type="checkbox"/> 5262AGRY	Gray	15A 125V	5-15R	<input type="checkbox"/> 5362AGRY	Gray	20A 125V	5-20R
<input type="checkbox"/> 5262ARED	Red	15A 125V	5-15R	<input type="checkbox"/> 5362ABK	Black	20A 125V	5-20R
<input type="checkbox"/> 5262ALA	Lt. Almond	15A 125V	5-15R	<input type="checkbox"/> 5362ARED	Red	20A 125V	5-20R
<input type="checkbox"/> CR6200*	Yellow	15A 125V	5-15R	<input type="checkbox"/> 5362ALA	Lt. Almond	20A 125V	5-20R
<input type="checkbox"/> 5662AI	Ivory	15A 250V	6-15R	<input type="checkbox"/> 5362ABL	Blue	20A 125V	5-20R
<input type="checkbox"/> 5662AW	White	15A 250V	6-15R	<input type="checkbox"/> CR6300*	Yellow	20A 125V	5-20R
<input type="checkbox"/> 5662A	Brown	15A 250V	6-15R	<input type="checkbox"/> 5862AI	Ivory	20A 250V	6-20R
<input type="checkbox"/> 5662AGRY	Gray	15A 250V	6-15R	<input type="checkbox"/> 5862AW	White	20A 250V	6-20R
<input type="checkbox"/> 5662ABK	Black	15A 250V	6-15R	<input type="checkbox"/> 5862A	Brown	20A 250V	6-20R
<input type="checkbox"/> 5662ARED	Red	15A 250V	6-15R	<input type="checkbox"/> 5862AGRY	Gray	20A 250V	6-20R
				<input type="checkbox"/> 5862ABK	Black	20A 250V	6-20R
				<input type="checkbox"/> 5862ARED	Red	20A 250V	6-20R
				<input type="checkbox"/> 5862ALA	Lt. Almond	20A 250V	6-20R

*Corrosion-Resistant

Performance

Electrical

Dielectric Voltage: Withstands 2000V minimum
 Maximum Working Voltage: 250V
 Current Interrupting: Certified for current interrupting at full-rated current
 Temperature Rise: Maximum 30°C temperature rise at full-rated current after 50 cycles of overload at 150% of rated current with direct current

Mechanical

Terminal Identification: Terminal Identification in accordance with UL498 (Brass, White, Green)
 Terminal Accommodation: #14 – #10 AWG copper conductor only
 Product Identification: Ratings are a permanent part of the device

Environmental

Flammability: UL94 V2
 Operating Temperature: Maximum continuous +60°C, minimum -40°C without impact

Materials

Face:	Nylon	Terminal Screws:	#10 Tri-Drive Brass (Neutral = Nickel-Plated Steel)
Back Body:	Nylon	Ground Screw:	#10 Hex Tri-Drive Brass
Line Contacts:**	.036 688 Brass	Assembly Drive Screw:	Zinc-Plated Steel
Mounting Strap:**	.050 688 Brass	Auto-Ground Clip:	Brass
Ground Contacts:	Strap with Integral Ground	Mounting Screws:	Tri-Drive Steel
Pressure Plate:	.031 260 Brass		

**Corrosion-Resistant versions have nickel-plated straps and contacts.
 Consult Straight Blade Section B for complete compliance listing.

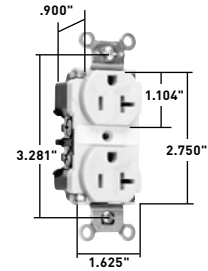

15 & 20 Amp

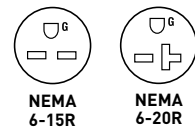
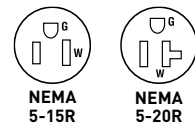

Project
Location/Type

TECHNICAL SPECIFICATIONS

Heavy-Duty Specification Grade Receptacles

Back & Side Wire 2 Pole, 3 Wire Grounding 15 & 20A, 125 & 250V

Typical Specifications

Manufacturer's Identification: Pass & Seymour® PS5262

Description: Straight Blade Duplex Receptacle – Heavy-Duty Specification Grade

Type: 2 Pole, 3 Wire Grounding

Rating: 15A, 125V

3rd Party Compliance: UL Listed, File Number E140596, Standard UL498, Federal Specification

WC596. CSA Certified, File Number LR16063, Standard CSA-C22.2 No. 42. Conforms to NEMA WD-1 and WD-6.

CATALOG NUMBER	COLOR	RATING	NEMA CONFIG. NO.	CATALOG NUMBER	COLOR	RATING	NEMA CONFIG. NO.
<input type="checkbox"/> PS5262I	Ivory	15A 125V	5-15R	<input type="checkbox"/> PS5362I	Ivory	20A 125V	5-20R
<input type="checkbox"/> PS5262W	White	15A 125V	5-15R	<input type="checkbox"/> PS5362W	White	20A 125V	5-20R
<input type="checkbox"/> PS5262	Brown	15A 125V	5-15R	<input type="checkbox"/> PS5362	Brown	20A 125V	5-20R
<input type="checkbox"/> PS5262GRY	Gray	15A 125V	5-15R	<input type="checkbox"/> PS5362GRY	Gray	20A 125V	5-20R
<input type="checkbox"/> PS5262BK	Black	15A 125V	5-15R	<input type="checkbox"/> PS5362BK	Black	20A 125V	5-20R
<input type="checkbox"/> PS5262RED	Red	15A 125V	5-15R	<input type="checkbox"/> PS5362RED	Red	20A 125V	5-20R
<input type="checkbox"/> PS5262LA	Lt. Almond	15A 125V	5-15R	<input type="checkbox"/> PS5362LA	Lt. Almond	20A 125V	5-20R
<input type="checkbox"/> 5662I	Ivory	15A 250V	6-15R	<input type="checkbox"/> PS5362BL	Blue	20A 125V	5-20R
<input type="checkbox"/> 5662W	White	15A 250V	6-15R	<input type="checkbox"/> 5862I	Ivory	20A 250V	6-20R
<input type="checkbox"/> 5662	Brown	15A 250V	6-15R	<input type="checkbox"/> 5862W	White	20A 250V	6-20R
				<input type="checkbox"/> 5862	Brown	20A 250V	6-20R
				<input type="checkbox"/> 5862GRY	Gray	20A 250V	6-20R
				<input type="checkbox"/> 5862BK	Black	20A 250V	6-20R
				<input type="checkbox"/> 5862RED	Red	20A 250V	6-20R

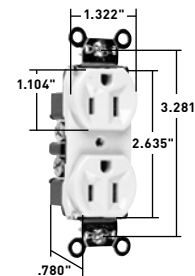

15 & 20 Amp

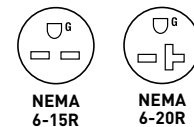
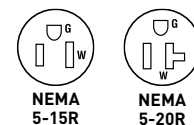

Performance

Electrical

Dielectric Voltage: Withstands 2000V minimum

Maximum Working Voltage: 250V

Current Interrupting: Certified for current interrupting at full-rated current

Temperature Rise: Max 30°C temperature rise at full-rated current after 50 cycles of overload at 150% of rated current with direct current

Mechanical

Terminal Identification: Terminal Identification in accordance with UL498 (Brass, White, Green)

Terminal Accommodation: #14 – #10 AWG copper conductor only

Product Identification: Ratings are a permanent part of the device

Environmental

Flammability: UL94 V2

Operating Temperature: Maximum continuous +60°C, minimum -40° (without impact)

Materials

Face: Nylon

Back Body: PVC

Line Contacts: .032 688 Brass

Mounting Strap: .043 688 Brass

Ground Contacts: .040 688 Brass

Pressure Plate: .080 Steel

Terminal Screws: #8 Tri-Drive Brass
(Neutral = Nickel-Plated Steel)

Ground Screw: #8 Hex Tri-Drive Brass

Assembly Drive Screw: Zinc-Plated Steel

Auto-Ground Clip: Stainless Steel

Mounting Screws: Tri-Drive Steel

Consult Straight Blade Section B for complete compliance listing.

Project
Location/Type

TECHNICAL SPECIFICATIONS

Heavy-Duty Hospital Grade Receptacles

Back & Side Wire 2 Pole, 3 Wire Grounding 15 & 20A, 125V

Typical Specifications

Manufacturer's Identification: Pass & Seymour® PS8200H
 Description: Straight Blade Duplex Receptacle – Heavy-Duty Hospital Grade
 Type: 2 Pole, 3 Wire Grounding
 Rating: 15A, 125V
 Configuration: NEMA 5-15R
 3rd Party Compliance: UL Listed, File Number E140596, Standard UL498. Federal Specification WC596, Hospital Grade. CSA Certified, File Number LR16063, Standard CSA C22.2 No. 42. Conforms to NEMA WD-1 and WD-6.

CATALOG NUMBER	COLOR	RATING	NEMA CONFIG. NO.
<input type="checkbox"/> PS8200HI	Ivory	15A 125V	5-15R
<input type="checkbox"/> PS8200HW	White	15A 125V	5-15R
<input type="checkbox"/> PS8200H	Brown	15A 125V	5-15R
<input type="checkbox"/> PS8200HGRY	Gray	15A 125V	5-15R
<input type="checkbox"/> PS8200HRED	Red	15A 125V	5-15R
<input type="checkbox"/> PS8200HLA	Lt. Almond	15A 125V	5-15R

CATALOG NUMBER	COLOR	RATING	NEMA CONFIG. NO.
<input type="checkbox"/> PS8300HI	Ivory	20A 125V	5-20R
<input type="checkbox"/> PS8300HW	White	20A 125V	5-20R
<input type="checkbox"/> PS8300H	Brown	20A 125V	5-20R
<input type="checkbox"/> PS8300HGRY	Gray	20A 125V	5-20R
<input type="checkbox"/> PS8300HRED	Red	20A 125V	5-20R
<input type="checkbox"/> PS8300HLA	Lt. Almond	20A 125V	5-20R

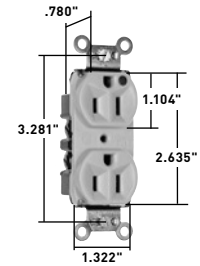

PS8200HI

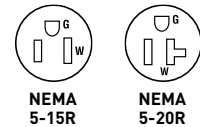

CATALOG NUMBER	COLOR	RATING	NEMA CONFIG. NO.
<input type="checkbox"/> PS8200HSI	Ivory	15A 125V	5-15R
<input type="checkbox"/> PS8200HSW	White	15A 125V	5-15R
<input type="checkbox"/> PS8200HS	Brown	15A 125V	5-15R
<input type="checkbox"/> PS8200HSGRY	Gray	15A 125V	5-15R
<input type="checkbox"/> PS8200HSRED	Red	15A 125V	5-15R
<input type="checkbox"/> PS8200HSLA	Lt. Almond	15A 125V	5-15R

CATALOG NUMBER	COLOR	RATING	NEMA CONFIG. NO.
<input type="checkbox"/> PS8300HSI	Ivory	20A 125V	5-20R
<input type="checkbox"/> PS8300HSW	White	20A 125V	5-20R
<input type="checkbox"/> PS8300HS	Brown	20A 125V	5-20R
<input type="checkbox"/> PS8300HSGRY	Gray	20A 125V	5-20R
<input type="checkbox"/> PS8300HSRED	Red	20A 125V	5-20R
<input type="checkbox"/> PS8300HSLA	Lt. Almond	20A 125V	5-20R

Performance

Electrical

Dielectric Voltage: Withstands 2000V minimum
 Maximum Working Voltage: 250V
 Current Interrupting: Certified for current interrupting at full-rated current
 Temperature Rise: Maximum 30°C temperature rise at full-rated current after 50 cycles of overload at 150% of rated current with direct current

Mechanical

Terminal Identification: Terminal Identification in accordance with UL498 (Brass, White, Green)
 Terminal Accommodation: #14 AWG – #10 AWG copper conductor only
 Product Identification: Ratings are a permanent part of the device

Environmental

Flammability: UL94 V2
 Operating Temperature: Maximum continuous +60°C, minimum -40°C without impact

Materials

Face:	Nylon	Terminal Screws :	#8 Tri-Drive Brass
Back Body:	PVC		(Neutral = Nickel-Plated Steel)
Line Contacts:	.032 688 Brass	Ground Screw:	#8 Hex Tri-Drive Brass
Mounting Strap:	.043 260 Brass	Mounting Screws:	Tri-Drive Steel
Ground Contacts:	.040 688 Brass		
Pressure Plate:	.080 Steel		

Consult Straight Blade Section B and Hospital Grade Section E for complete compliance listing.

TECHNICAL SPECIFICATIONS

Project
Location/Type

TECHNICAL SPECIFICATIONS

Heavy-Duty Hospital Grade Compact Design Receptacles

2 Pole, 3 Wire Grounding 15 & 20A, 125V; 20A, 250V

Typical Specifications

Manufacturer's Identification: Pass & Seymour® 8200H
 Description: Straight Blade Duplex Receptacle – Heavy-Duty Hospital Grade
 Type: 2 Pole, 3 Wire Grounding
 Rating: 15A, 125V
 Configuration: NEMA 5-15R
 3rd Party Compliance: UL Listed, File Number E140596, Standard UL498. Federal Specification WC596, Hospital Grade. CSA Certified, File Number LR16063, Standard CSA C22.2 No. 42. Conforms to NEMA WD-1 and WD-6.

CATALOG NUMBER	COLOR	RATING	NEMA CONFIG. NO.	CATALOG NUMBER	COLOR	RATING	NEMA CONFIG. NO.
<input type="checkbox"/> 8200HI	Ivory	15A 125V	5-15R	<input type="checkbox"/> IG8200I	Ivory	15A 125V	5-15R
<input type="checkbox"/> 8200HW	White	15A 125V	5-15R	<input type="checkbox"/> IG8200RED	Red	15A 125V	5-15R
<input type="checkbox"/> 8200H	Brown	15A 125V	5-15R	<input type="checkbox"/> IG8200	Orange	15A 125V	5-15R
<input type="checkbox"/> 8200HGRY	Gray	15A 125V	5-15R	<input type="checkbox"/> IG8300I	Ivory	20A 125V	5-20R
<input type="checkbox"/> 8200HRED	Red	15A 125V	5-15R	<input type="checkbox"/> IG8300W	White	20A 125V	5-20R
<input type="checkbox"/> 8200HLA	Lt. Almond	15A 125V	5-15R	<input type="checkbox"/> IG8300RED	Red	20A 125V	5-20R
<input type="checkbox"/> 8300HI	Ivory	20A 125V	5-20R	<input type="checkbox"/> IG8300LA	Lt. Almond	20A 125V	5-20R
<input type="checkbox"/> 8300HW	White	20A 125V	5-20R	<input type="checkbox"/> IG8300	Orange	20A 125V	5-20R
<input type="checkbox"/> 8300H	Brown	20A 125V	5-20R	<input type="checkbox"/> IG8800LA	Lt. Almond	20A 250V	6-20R
<input type="checkbox"/> 8300HGRY	Gray	20A 125V	5-20R	<input type="checkbox"/> IG8800	Orange	20A 250V	6-20R
<input type="checkbox"/> 8300HBK	Black	20A 125V	5-20R				
<input type="checkbox"/> 8300HRED	Red	20A 125V	5-20R				
<input type="checkbox"/> 8300HLA	Lt. Almond	20A 125V	5-20R				
<input type="checkbox"/> 8300HOR	Orange	20A 125V	5-20R				

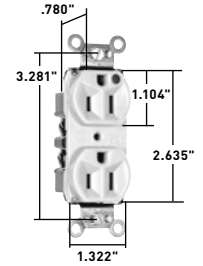

8200HI

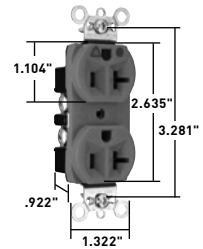

IG8300

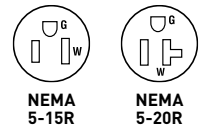

NEMA 5-15R

NEMA 5-20R



NEMA 6-20R

Performance

Electrical

Dielectric Voltage: Withstands 2000V minimum
 Maximum Working Voltage: 250V
 Current Interrupting: Certified for current interrupting at full-rated current
 Temperature Rise: Maximum 30°C temperature rise at full-rated current after 50 cycles of overload at 150% of rated current with direct current

Mechanical

Terminal Identification: Terminal Identification in accordance with UL498 (Brass, White, Green)
 Terminal Accommodation: #14 AWG – #10 AWG copper conductor only
 Product Identification: Ratings are a permanent part of the device

Environmental

Flammability: UL94 V2
 Operating Temperature: Maximum continuous +60°C, minimum -40°C without impact

Materials

Face:	Nylon	Terminal Screws:	#8 Tri-Drive Brass
Back Body:	PVC		(Neutral = Nickel-Plated Steel)
Line Contacts:	.032 688 Brass	Ground Screw:	#8 Hex Tri-Drive Brass
Mounting Strap:	.043 260 Brass	Assembly Drive Screw:	Zinc-Plated Steel
Ground Contacts:	.040 688 Brass	Auto-Ground Clip:	Stainless Steel
Pressure Plate:	.080 Steel	Mounting Screws:	Tri-Drive Steel

Consult Straight Blade Section B and Hospital Grade Section E for complete compliance listing.

Project
Location/Type

TECHNICAL SPECIFICATIONS

Tamper-Resistant Hospital Grade & Power Indicating Receptacles

2 Pole, 3 Wire Grounding 15 & 20A, 125V

Typical Specifications

Manufacturer's Identification: Pass & Seymour® TR8200H
 Description: Straight Blade Duplex Receptacle – Hospital Grade Tamper-Resistant
 Type: 2 Pole, 3 Wire Grounding
 Rating: 15A, 125V
 Configuration: NEMA 5-15R
 3rd Party Compliance: UL Listed, File Number E140596, Standard UL498. Federal Specification WC596, Hospital Grade. CSA Certified, File Number LR16063, Standard CSA C22.2 No. 42. Conforms to NEMA WD-1 and WD-6.

CATALOG NUMBER	COLOR	RATING	NEMA CONFIG. NO.	CATALOG NUMBER	COLOR	RATING	NEMA CONFIG. NO.
<input type="checkbox"/> TR8200HI	Ivory	15A 125V	5-15R	<input type="checkbox"/> TR8300HI	Ivory	20A 125V	5-20R
<input type="checkbox"/> TR8200HW	White	15A 125V	5-15R	<input type="checkbox"/> TR8300HW	White	20A 125V	5-20R
<input type="checkbox"/> TR8200HBK	Black	15A 125V	5-15R	<input type="checkbox"/> TR8300H	Brown	20A 125V	5-20R
<input type="checkbox"/> TR8200HGRY	Gray	15A 125V	5-15R	<input type="checkbox"/> TR8300HGRY	Gray	20A 125V	5-20R
<input type="checkbox"/> TR8200HRED	Red	15A 125V	5-15R	<input type="checkbox"/> TR8300HRED	Red	20A 125V	5-20R
<input type="checkbox"/> TR8200HLA	Lt. Almond	15A 125V	5-15R	<input type="checkbox"/> TR8300HLA	Lt. Almond	20A 125V	5-20R
				<input type="checkbox"/> TR8300HBK	Black	20A 125V	5-20R
				<input type="checkbox"/> TR8300HBL	Blue	20A 125V	5-20R

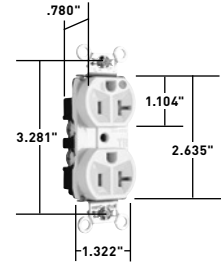

TR8300HW

CATALOG NUMBER	COLOR	RATING	NEMA CONFIG. NO.	CATALOG NUMBER	COLOR	RATING	NEMA CONFIG. NO.
<input type="checkbox"/> TR8200PI	Brown	15 125	5-15R	<input type="checkbox"/> TR8200HPI	Brown	15 125	5-15R
<input type="checkbox"/> TR8200PIW	White	15 125	5-15R	<input type="checkbox"/> TR8200HPIW	White	15 125	5-15R
<input type="checkbox"/> TR8200PILA	Lt. Almond	15 125	5-15R	<input type="checkbox"/> TR8200HPILA	Lt. Almond	15 125	5-15R
<input type="checkbox"/> TR8200PII	Ivory	15 125	5-15R	<input type="checkbox"/> TR8200HPII	Ivory	15 125	5-15R
<input type="checkbox"/> TR8200PIRED	Red	15 125	5-15R	<input type="checkbox"/> TR8200HPIRED	Red	15 125	5-15R
<input type="checkbox"/> TR8200PIGRY	Gray	15 125	5-15R	<input type="checkbox"/> TR8200HPIGRY	Gray	15 125	5-15R
<input type="checkbox"/> TR8300PI	Brown	20 125	5-20R	<input type="checkbox"/> TR8300HPI	Brown	20 125	5-20R
<input type="checkbox"/> TR8300PIW	White	20 125	5-20R	<input type="checkbox"/> TR8300HPIW	White	20 125	5-20R
<input type="checkbox"/> TR8300PILA	Lt. Almond	20 125	5-20R	<input type="checkbox"/> TR8300HPILA	Lt. Almond	20 125	5-20R
<input type="checkbox"/> TR8300PII	Ivory	20 125	5-20R	<input type="checkbox"/> TR8300HPII	Ivory	20 125	5-20R
<input type="checkbox"/> TR8300PIRED	Red	20 125	5-20R	<input type="checkbox"/> TR8300HPIRED	Red	20 125	5-20R
<input type="checkbox"/> TR8300PIGRY	Gray	20 125	5-20R	<input type="checkbox"/> TR8300HPIGRY	Gray	20 125	5-20R

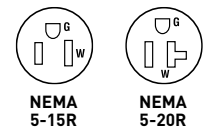

Performance

Electrical

Dielectric Voltage: Withstands 2000V minimum
 Maximum Working Voltage: 250V
 Current Interrupting: Certified for current interrupting at full-rated current
 Temperature Rise: Maximum 30°C temperature rise at full-rated current after 50 cycles of overload at 150% of rated current with direct current

Mechanical

Terminal Identification: Terminal Identification in accordance with UL498 (Brass, White, Green)
 Terminal Accommodation: #14 AWG – #10 AWG copper conductor only
 Product Identification: Ratings are a permanent part of the device

Environmental

Flammability: UL94 V2
 Operating Temperature: Maximum continuous +60°C, minimum -40°C without impact

Materials

Face:	Nylon	Terminal Screws:	#8 Tri-Drive Brass
Back Body:	PVC		(Neutral = Nickel-Plated Steel)
Line Contacts:	.032 688 Brass	Ground Screw:	#8 Hex Tri-Drive Brass
Mounting Strap:	.042" Zinc-Plated Steel	Assembly Drive Screw:	Zinc-Plated Steel
Ground Contacts:	.040 688 Brass	Auto-Ground Clip:	Stainless Steel
Pressure Plate:	.080 Steel	Mounting Screws:	Tri-Drive Steel

Consult Straight Blade Section B and Hospital Grade Section E for complete compliance listing.

Project
Location/Type



TECHNICAL SPECIFICATIONS

PlugTail® Specification & Hospital Grade Receptacles

2 Pole, 3 Wire Grounding 15 & 20A, 125V

Typical Specifications

Manufacturer's Identification: Pass & Seymour® PT5262
 Description: Plugtail® Straight Blade Duplex Receptacle – Specification Grade
 Type: 2 Pole, 3 Wire Grounding
 Rating: 15A, 125V
 3rd Party Compliance: cULus Listed, File Number E140596, Standard UL498. Federal Specification WC596.
 Conforms to NEMA WD-1 and WD-6.

CATALOG NUMBER	COLOR	RATING	NEMA CONFIG. NO.	CATALOG NUMBER	COLOR	RATING	NEMA CONFIG. NO.
<input type="checkbox"/> PT5262I	Ivory	15A 125V	5-15R	<input type="checkbox"/> PTIG5262W	White	15A 125V	5-15R
<input type="checkbox"/> PT5262W	White	15A 125V	5-15R	<input type="checkbox"/> PTIG5262	Orange	15A 125V	5-15R
<input type="checkbox"/> PT5262	Brown	15A 125V	5-15R	<input type="checkbox"/> PTIG5262RED	Red	15A 125V	5-15R
<input type="checkbox"/> PT5262GRY	Gray	15A 125V	5-15R	<input type="checkbox"/> PTIG5262LA	Lt. Almond	15A 125V	5-15R
<input type="checkbox"/> PT5262BK	Black	15A 125V	5-15R	<input type="checkbox"/> PTIG5362I	Ivory	20A 125V	5-20R
<input type="checkbox"/> PT5262RED	Red	15A 125V	5-15R	<input type="checkbox"/> PTIG5362W	White	20A 125V	5-20R
<input type="checkbox"/> PT5262BL	Blue	15A 125V	5-15R	<input type="checkbox"/> PTIG5362	Orange	20A 125V	5-20R
<input type="checkbox"/> PT5362I	Ivory	20A 125V	5-20R	<input type="checkbox"/> PTIG5362GRY	Gray	20A 125V	5-20R
<input type="checkbox"/> PT5362W	White	20A 125V	5-20R	<input type="checkbox"/> PTIG5362RED	Red	20A 125V	5-20R
<input type="checkbox"/> PT5362	Brown	20A 125V	5-20R	<input type="checkbox"/> PTIG5362LA	Lt. Almond	20A 125V	5-20R
<input type="checkbox"/> PT5362GRY	Gray	20A 125V	5-20R	<input type="checkbox"/> PTIG8200	Orange	15A 125V	5-15R
<input type="checkbox"/> PT5362BK	Black	20A 125V	5-20R	<input type="checkbox"/> PTIG8200RED	Red	15A 125V	5-15R
<input type="checkbox"/> PT5362RED	Red	20A 125V	5-20R	<input type="checkbox"/> PTIG8300I	Ivory	15A 125V	5-15R
<input type="checkbox"/> PT5362LA	Lt. Almond	20A 125V	5-20R	<input type="checkbox"/> PTIG8300	Orange	15A 125V	5-15R
<input type="checkbox"/> PT5362BL	Blue	20A 125V	5-20R	<input type="checkbox"/> PTIG8300RED	Red	15A 125V	5-15R

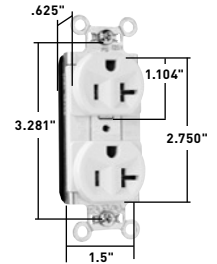

PT5362LA

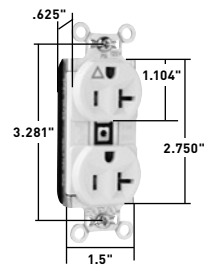

PTIG5362LA

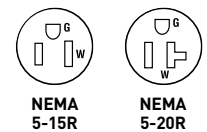

Performance

Electrical

Dielectric Voltage: Withstands 2000V minimum
 Maximum Working Voltage: 125V
 Current Interrupting: Certified for current interrupting at full-rated current (receptacle only)
 Temperature Rise: Maximum 30°C temperature rise at full-rated current after 50 cycles of overload at 150% of rated current with direct current

Mechanical

PlugTail Connector Identification: #12 AWG, THHN, copper conductor, 6" leads, stripped, solid or stranded, for use with PlugTail Receptacles only

Product Identification: Ratings are a permanent part of the device

Environmental

Flammability: UL94 V2
 Operating Temperature: Maximum continuous +60°C, minimum -40°C without impact

PlugTail Receptacle Materials

Face:	Nylon	Integral Ground System:	.036 260 Brass
Back Body:	PVC	Assembly Drive Screw:	Zinc-Plated Steel
Line Contacts:	.036 688 Brass	Auto-Ground Clip:	Steel
Mounting Strap:	.042 Zinc-Plated Steel	Mounting Screws:	Tri-Drive Steel

PlugTail Connector Materials

Housing	Polycarbonate	Contacts	.030 Brass
---------	---------------	----------	------------

Consult Straight Blade Section B and Hospital Grade Section E for complete compliance listing.

Project
Location/Type

TECHNICAL SPECIFICATIONS

PlugTail® Tamper-Resistant Specification, Hospital Grade & Power Indicating Receptacles

2 Pole, 3 Wire Grounding 15 & 20A, 125V

Typical Specifications

Manufacturer's Identification: Pass & Seymour® PTTR5262

Description: PlugTail® Straight Blade Duplex Receptacle – Specification Grade

Type: 2 Pole, 3 Wire Grounding

Rating: 15A, 125V

3rd Party Compliance: cULus Listed, File Number E140596, Standard UL498. Federal Specification WC596.

Conforms to NEMA WD-1 and WD-6.

CATALOG NUMBER	COLOR	RATING	NEMA CONFIG. NO.	CATALOG NUMBER	COLOR	RATING	NEMA CONFIG. NO.
<input type="checkbox"/> PTTR5262I	Ivory	15A 125V	5-15R	<input type="checkbox"/> PTTR8200I	Ivory	15A 125V	5-15R
<input type="checkbox"/> PTTR5262W	White	15A 125V	5-15R	<input type="checkbox"/> PTTR8200W	White	15A 125V	5-15R
<input type="checkbox"/> PTTR5262	Brown	15A 125V	5-15R	<input type="checkbox"/> PTTR8200RED	Red	15A 125V	5-15R
<input type="checkbox"/> PTTR5262GRY	Gray	15A 125V	5-15R	<input type="checkbox"/> PTTR8300I	Ivory	20A 125V	5-20R
<input type="checkbox"/> PTTR5262RED	Red	15A 125V	5-15R	<input type="checkbox"/> PTTR8300W	White	20A 125V	5-20R
<input type="checkbox"/> PTTR5262LA	Lt. Almond	15A 125V	5-15R	<input type="checkbox"/> PTTR8300	Brown	20A 125V	5-20R
<input type="checkbox"/> PTTR5362I	Ivory	20A 125V	5-20R	<input type="checkbox"/> PTTR8300GRY	Gray	20A 125V	5-20R
<input type="checkbox"/> PTTR5362W	White	20A 125V	5-20R	<input type="checkbox"/> PTTR8300BK	Black	20A 125V	5-20R
<input type="checkbox"/> PTTR5362	Brown	20A 125V	5-20R	<input type="checkbox"/> PTTR8300RED	Red	20A 125V	5-20R
<input type="checkbox"/> PTTR5362GRY	Gray	20A 125V	5-20R	<input type="checkbox"/> PTTR8300LA	Lt. Almond	20A 125V	5-20R
<input type="checkbox"/> PTTR5362BK	Black	20A 125V	5-20R				
<input type="checkbox"/> PTTR5362LA	Lt. Almond	20A 125V	5-20R				

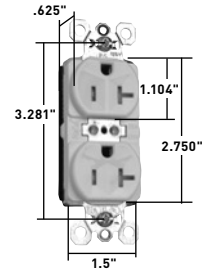

PTTR5362W

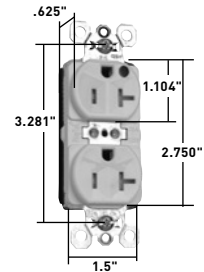

PTTR8300W

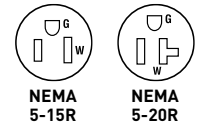

NEMA 5-15R

NEMA 5-20R

CATALOG NUMBER	COLOR	RATING	NEMA CONFIG. NO.
<input type="checkbox"/> PTTR8200PII	Ivory	15A 125V	5-15R
<input type="checkbox"/> PTTR8200PIW	White	15A 125V	5-15R
<input type="checkbox"/> PTTR8200PI	Brown	15A 125V	5-15R
<input type="checkbox"/> PTTR8200PIGRY	Gray	15A 125V	5-15R
<input type="checkbox"/> PTTR8200PIRED	Red	15A 125V	5-15R
<input type="checkbox"/> PTTR8200PILA	Lt. Almond	15A 125V	5-15R
<input type="checkbox"/> PTTR8300PII	Ivory	20A 125V	5-20R
<input type="checkbox"/> PTTR8300PIW	White	20A 125V	5-20R
<input type="checkbox"/> PTTR8300PI	Brown	20A 125V	5-20R
<input type="checkbox"/> PTTR8300PIGRY	Gray	20A 125V	5-20R
<input type="checkbox"/> PTTR8300PIRED	Red	20A 125V	5-20R
<input type="checkbox"/> PTTR8300PILA	Lt. Almond	20A 125V	5-20R

Performance

Electrical

Dielectric Voltage: Withstands 2000V minimum

Maximum Working Voltage: 125V

Current Interrupting: Certified for current interrupting at full-rated current (receptacle only)

Temperature Rise: Maximum 30°C temperature rise at full-rated current after 50 cycles of overload at 150% of rated current with direct current

Mechanical

PlugTail Connector Identification: #12 AWG, THHN, copper conductor, 6" leads, stripped, solid or stranded, for use with PlugTail Receptacles only

Product Identification: Ratings are a permanent part of the device

Environmental

Flammability: UL94 V2

Operating Temperature: Maximum continuous +60°C, minimum -40°C without impact

PlugTail Receptacle Materials

Face:	Nylon	Integral Ground System:	.036 260 Brass
Back Body:	PVC	Assembly Drive Screw:	Zinc-Plated Steel
Line Contacts:	.036 688 Brass	Auto-Ground Clip:	Steel
Mounting Strap:	.042 Zinc-Plated Steel	Mounting Screws:	Tri-Drive Steel

PlugTail Connector Materials

Housing:	Polycarbonate	Contacts:	.030 Brass
----------	---------------	-----------	------------

Consult Straight Blade Section B and Hospital Grade Section E for complete compliance listing.

Project
Location/Type

TECHNICAL SPECIFICATIONS

PlugTail® Hospital Grade Receptacles

2 Pole, 3 Wire Grounding 15 & 20A, 125V

Typical Specifications

Manufacturer's Identification: Pass & Seymour® PT8200H

Description: PlugTail® Straight Blade Duplex Receptacle – Hospital Grade

Type: 2 Pole, 3 Wire Grounding

Rating: 15A, 125V

3rd Party Compliance: cUL Listed, File Number E140596, Standard UL498. Federal Specification WC596.

Hospital Grade, UN SPSC: 3912406 CSA Listing: C22.2 No. 42. Conforms to NEMA WD-1 and WD-6.

CATALOG NUMBER	COLOR	RATING	NEMA CONFIG. NO.
<input type="checkbox"/> PT8200HI	Ivory	15A 125V	5-15R
<input type="checkbox"/> PT8200HW	White	15A 125V	5-15R
<input type="checkbox"/> PT8200HGRY	Gray	15A 125V	5-15R
<input type="checkbox"/> PT8200HRED	Red	15A 125V	5-15R
<input type="checkbox"/> PT8200HLA	Lt. Almond	15A 125V	5-15R
<input type="checkbox"/> PT8300HI	Ivory	20A 125V	5-20R
<input type="checkbox"/> PT8300HW	White	20A 125V	5-20R
<input type="checkbox"/> PT8300H	Brown	20A 125V	5-20R
<input type="checkbox"/> PT8300HGRY	Gray	20A 125V	5-20R
<input type="checkbox"/> PT8300HBK	Black	20A 125V	5-20R
<input type="checkbox"/> PT8300HRED	Red	20A 125V	5-20R
<input type="checkbox"/> PT8300HLA	Lt. Almond	20A 125V	5-20R

Performance

Electrical

Dielectric Voltage: Withstands 2000V minimum

Maximum Working Voltage: 125V

Current Interrupting: Certified for current interrupting at full-rated current (receptacle only)

Temperature Rise: Maximum 30°C temperature rise at full-rated current after 50 cycles of overload at 150% of rated current with direct current

Mechanical

PlugTail Connector

Identification: #12 AWG, THHN, copper conductor, 6" leads, stripped, solid or stranded, for use with PlugTail Receptacles only

Product Identification: Ratings are a permanent part of the device

Environmental

Flammability: UL94 V2

Operating Temperature: Maximum continuous +60°C, minimum -40°C without impact

PlugTail Receptacle Materials

Face: Nylon

Back Body: PVC

Line Contacts: .036 688 Brass

Mounting Strap: .042 Zinc-Plated Steel

Integral Ground System: .036 260 Brass

Assembly Drive Screw: Zinc-Plated Steel

Auto-Ground Clip: Steel

Mounting Screws: Tri-Drive Steel

PlugTail Connector Materials

Housing: Polycarbonate

Contacts: .036 688 Brass

Consult Straight Blade Section B and Hospital Grade Section E for complete compliance listing.

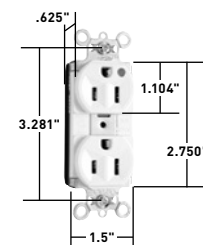

PT8200HW

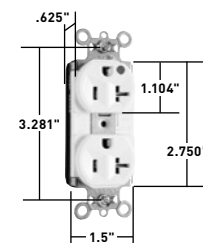

PT8300HW

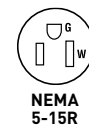

NEMA
5-15R

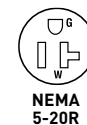

NEMA
5-20R

Project

Location/Type

TECHNICAL SPECIFICATIONS

PlugTail® Specification Grade Receptacles Split Circuit

2 Pole, 3 Wire Grounding 15 & 20A, 125V

Typical Specifications

Manufacturer's Identification: Pass & Seymour® PT5262SC
 Description: PlugTail® Straight Blade Duplex Receptacle – Specification Grade
 Type: 2 Pole, 3 Wire Grounding
 Rating: 15A, 125V
 3rd Party Compliance: cULus Listed, File Number E140596, Standard UL498. Federal Specification WC596. Conforms to NEMA WD-1 and WD-6.

CATALOG NUMBER	COLOR	RATING	NEMA CONFIG. NO.	CATALOG NUMBER	COLOR	RATING	NEMA CONFIG. NO.
<input type="checkbox"/> PT5262SCW	White	15A 125V	5-15R	<input type="checkbox"/> PTTR5262SCW	White	15A 125V	5-15R
<input type="checkbox"/> PT5262SC	Brown	15A 125V	5-15R	<input type="checkbox"/> PTTR5362SCI	Ivory	20A 125V	5-20R
<input type="checkbox"/> PT5262SCBK	Black	15A 125V	5-15R	<input type="checkbox"/> PTTR5362SCW	White	20A 125V	5-20R
<input type="checkbox"/> PT5362SCI	Ivory	20A 125V	5-20R				
<input type="checkbox"/> PT5362SCW	White	20A 125V	5-20R				
<input type="checkbox"/> PT5362SC	Brown	20A 125V	5-20R				
<input type="checkbox"/> PT5362SCGRY	Gray	20A 125V	5-20R				
<input type="checkbox"/> PT5362SCLA	Lt. Almond	20A 125V	5-20R				

Performance

Electrical

Dielectric Voltage: Withstands 2000V minimum
 Maximum Working Voltage: 125V
 Current Interrupting: Certified for current interrupting at full-rated current (receptacle only)
 Temperature Rise: Maximum 30°C temperature rise at full-rated current after 50 cycles of overload at 150% of rated current with direct current

Mechanical

PlugTail Connector Identification: #12 AWG, THHN, copper conductor, 6" leads, stripped, solid or stranded, for use with PlugTail Receptacles only
 Product Identification: Ratings are a permanent part of the device

Environmental

Flammability: UL94 V2
 Operating Temperature: Maximum continuous +60°C, minimum -40°C without impact

PlugTail Receptacle Materials

Face: Nylon
 Back Body: PVC
 Line Contacts: .036 688 Brass
 Mounting Strap: .042 Zinc-Plated Steel
 Integral Ground System: .036 260 Brass
 Assembly Drive Screw: Zinc-Plated Steel
 Auto-Ground Clip: Steel
 Mounting Screws: Tri-Drive Steel

PlugTail Connector Materials

Housing: Polycarbonate
 Contacts: .030 Brass

Consult Straight Blade Section B for complete compliance listing.

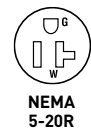
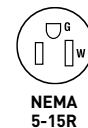
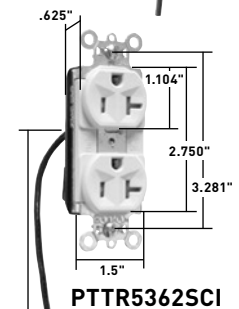
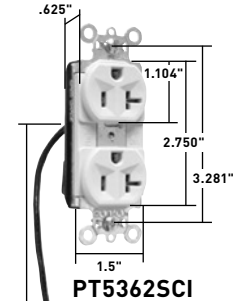

Project
Location/Type

TECHNICAL SPECIFICATIONS

Hard Use Specification Grade Receptacles

Back & Side Wire 2 Pole, 3 Wire Grounding 15 & 20A, 125 & 250V

Typical Specifications

Manufacturer's Identification: Pass & Seymour® 5262

Description: Straight Blade Duplex Receptacle – Hard Use Specification Grade

Type: 2 Pole, 3 Wire Grounding

Rating: 15A, 125V

3rd Party Compliance: UL Listed, File Number E140596, Standard UL498, Federal Specification

WC596. CSA Certified, File Number LR16063, Standard CSA-C22.2 No. 42.27. Conforms to NEMA WD-1 and WD-6.

CATALOG NUMBER	COLOR	RATING	NEMA CONFIG. NO.	CATALOG NUMBER	COLOR	RATING	NEMA CONFIG. NO.
☐ 5262I	Ivory	15A 125V	5-15R	☐ 5362BK	Black	20A 125V	5-20R
☐ 5262W	White	15A 125V	5-15R	☐ 5362RED	Red	20A 125V	5-20R
☐ 5262	Brown	15A 125V	5-15R	☐ 5362LA	Lt. Almond	20A 125V	5-20R
☐ 5262GRY	Gray	15A 125V	5-15R	☐ 5362BL	Blue	20A 125V	5-20R
☐ 5262BK	Black	15A 125V	5-15R	☐ 5362GN	Green	20A 125V	5-20R
☐ 5262RED	Red	15A 125V	5-15R	☐ 5362OR	Orange	20A 125V	5-20R
☐ 5262LA	Lt. Almond	15A 125V	5-15R	☐ 5290I*	Ivory	15A 125/250V	5/6-15R
☐ 5362I	Ivory	20A 125V	5-20R	☐ 5290*	Brown	15A 125/250V	5/6-15R
☐ 5362W	White	20A 125V	5-20R	☐ 5890I*	Ivory	20A 125/250V	5/6-20R
☐ 5362	Brown	20A 125V	5-20R	☐ 5890W*	White	20A 125/250V	5/6-20R
☐ 5362GRY	Gray	20A 125V	5-20R	☐ 5890*	Brown	20A 125/250V	5/6-20R

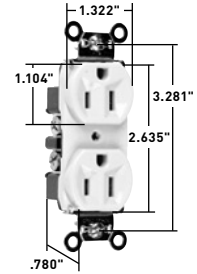

15 & 20 Amp

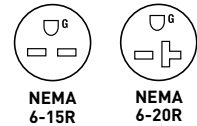
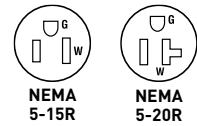

*Side wire only.

Performance

Electrical

Dielectric Voltage: Withstands 2000V minimum

Maximum Working Voltage: 250V

Current Interrupting: Certified for current interrupting at full-rated current

Temperature Rise: Max 30°C temperature rise at full-rated current after 50 cycles of overload at 150% of rated current with direct current

Mechanical

Terminal Identification: Terminal Identification in accordance with UL498 (Brass, White, Green)

Terminal Accommodation: #14 – #10 AWG copper conductor only

Product Identification: Ratings are a permanent part of the device

Environmental

Flammability: UL94 V2

Operating Temperature: Maximum continuous +60°C, minimum -40°C (without impact)

Materials

Face: Nylon

Back Body: PVC

Contacts: .032" (.8) Brass

Clamping Plate: .080" Steel

Mounting Strap: .042" Steel

Terminal Screws: Tri-Drive Brass

Hex Head

Grounding Screw: Tri-Drive Zinc-Plated Steel

Assembly Rivets: Steel

Auto-Ground Clip: Stainless Steel

Mounting Screws: Tri-Drive Steel

Consult Straight Blade Section B for complete compliance listing.

Project
Location/Type

TECHNICAL SPECIFICATIONS

Plug Load Controllable Decorator Receptacles

Back & Side Wire 2 Pole, 3 Wire Grounding 15 & 20A, 125 & 250V

Typical Specifications

Manufacturer's Identification: Pass & Seymour® 26252CH

Description: Straight Blade Duplex Receptacle – Plug Load Controllable Decorator Receptacles

Type: 2 Pole, 3 Wire Grounding

Rating: 15A, 125V

3rd Party Compliance: UL Listed, File Number E140596, Standard UL498, Federal Specification

WC596. CSA/CUL Certified, File Number LR16063, Standard CSA-C22.2 No. 42. Conforms to NEMA WD-1 and WD-6.

CATALOG NUMBER	COLOR	RATING	NEMA CONFIG. NO.	CATALOG NUMBER	COLOR	RATING	NEMA CONFIG. NO.
<input type="checkbox"/> 26252CHI	Ivory	15A 125V	5-15R	<input type="checkbox"/> 26252CDI	Ivory	15A 125V	5-15R
<input type="checkbox"/> 26252CHW	White	15A 125V	5-15R	<input type="checkbox"/> 26252CDW	White	15A 125V	5-15R
<input type="checkbox"/> 26252CH	Brown	15A 125V	5-15R	<input type="checkbox"/> 26252CD	Brown	15A 125V	5-15R
<input type="checkbox"/> 26252CHGRY	Gray	15A 125V	5-15R	<input type="checkbox"/> 26252CDGRY	Gray	15A 125V	5-15R
<input type="checkbox"/> 26252CHBK	Black	15A 125V	5-15R	<input type="checkbox"/> 26252CDBK	Black	15A 125V	5-15R
<input type="checkbox"/> 26252CHRED	Red	15A 125V	5-15R	<input type="checkbox"/> 26252CDGN	Green	15A 125V	5-15R
<input type="checkbox"/> 26252CHLA	Lt. Almond	15A 125V	5-15R	<input type="checkbox"/> 26252CDLA	Lt. Almond	15A 125V	5-15R
<input type="checkbox"/> 26252CHGN	Green	15A 125V	5-15R	<input type="checkbox"/> 26252CDBL	Blue	15A 125V	5-15R
<input type="checkbox"/> 26352CHI	Ivory	20A 125V	5-20R	<input type="checkbox"/> 26352CDI	Ivory	20A 125V	5-20R
<input type="checkbox"/> 26352CHW	White	20A 125V	5-20R	<input type="checkbox"/> 26352CDW	White	20A 125V	5-20R
<input type="checkbox"/> 26352CH	Brown	20A 125V	5-20R	<input type="checkbox"/> 26352CD	Brown	20A 125V	5-20R
<input type="checkbox"/> 26352CHGRY	Gray	20A 125V	5-20R	<input type="checkbox"/> 26352CDGRY	Gray	20A 125V	5-20R
<input type="checkbox"/> 26352CHBK	Black	20A 125V	5-20R	<input type="checkbox"/> 26352CDBK	Black	20A 125V	5-20R
<input type="checkbox"/> 26352CHRED	Red	20A 125V	5-20R	<input type="checkbox"/> 26352CDGN	Green	20A 125V	5-20R
<input type="checkbox"/> 26352CHLA	Lt. Almond	20A 125V	5-20R	<input type="checkbox"/> 26352CDLA	Lt. Almond	20A 125V	5-20R
<input type="checkbox"/> 26352CHBL	Blue	20A 125V	5-20R	<input type="checkbox"/> 26352CDBL	Blue	20A 125V	5-20R
<input type="checkbox"/> 26352CHGN	Green	20A 125V	5-20R				

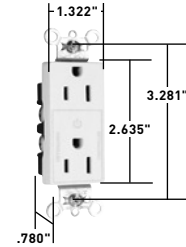

26252CHW

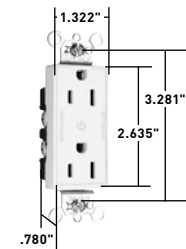

26252CDW

2 Pole, 3 Wire

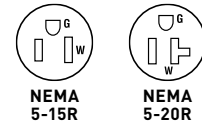

Performance

Electrical

- Dielectric Voltage: Withstands 2000V minimum
- Maximum Working Voltage: 250V
- Current Interrupting: Certified for current interrupting at full-rated current
- Temperature Rise: Max 30°C temperature rise at full-rated current after 50 cycles of overload at 150% of rated current with direct current

Mechanical

- Terminal Identification: Terminal Identification in accordance with UL498 (Brass, White, Green)
- Terminal Accommodation: #14 – #10 AWG copper conductor only
- Product Identification: Ratings are a permanent part of the device

Environmental

- Flammability: UL94 V2
- Operating Temperature: Maximum continuous +60°C, minimum -40°C (without impact)

Materials

- Face: Nylon
- Back Body: PVC
- Contacts: .032" 688 Brass
- Clamping Plate: .080" Steel
- Mounting Strap: .042" Zinc-Plated Steel
- Terminal Screws: #8 Tri-Drive Steel (Neutral = Nickel-Plated Steel)
- Grounding Screw: #8 Hex Tri-Drive Steel
- Assembly Drive Screw: Zinc-Plated Steel
- Auto-Ground Clip: Stainless Steel
- Mounting Screws: Tri-Drive Steel
- Ink: Pad Printed

Consult Straight Blade Section B for complete compliance listing.

TECHNICAL SPECIFICATIONS

Project
Location/Type

TECHNICAL SPECIFICATIONS

Plug Load Controllable Receptacles

Back & Side Wire 2 Pole, 3 Wire Grounding 15 & 20A, 125 & 250V

Typical Specifications

Manufacturer's Identification: Pass & Seymour® 5262CH
 Description: Straight Blade Duplex Receptacle – Plug Load Controllable Duplex Receptacles
 Type: 2 Pole, 3 Wire Grounding
 Rating: 15A, 125V
 3rd Party Compliance: UL Listed, File Number E140596, Standard UL498, Federal Specification WC596. CSA Certified, File Number LR16063, Standard CSA-C22.2 No. 42. Conforms to NEMA WD-1 and WD-6.

CATALOG NUMBER	COLOR	RATING	NEMA CONFIG. NO.	CATALOG NUMBER	COLOR	RATING	NEMA CONFIG. NO.
<input type="checkbox"/> 5262CHI	Ivory	15A 125V	5-15R	<input type="checkbox"/> 5262CDI	Ivory	15A 125V	5-15R
<input type="checkbox"/> 5262CHW	White	15A 125V	5-15R	<input type="checkbox"/> 5262CDW	White	15A 125V	5-15R
<input type="checkbox"/> 5262CH	Brown	15A 125V	5-15R	<input type="checkbox"/> 5262CD	Brown	15A 125V	5-15R
<input type="checkbox"/> 5262CHGRY	Gray	15A 125V	5-15R	<input type="checkbox"/> 5262CDGRY	Gray	15A 125V	5-15R
<input type="checkbox"/> 5262CHBK	Black	15A 125V	5-15R	<input type="checkbox"/> 5262CDBK	Black	15A 125V	5-15R
<input type="checkbox"/> 5262CHGN	Green	15A 125V	5-15R	<input type="checkbox"/> 5262CDGN	Green	15A 125V	5-15R
<input type="checkbox"/> 5262CHLA	Lt. Almond	15A 125V	5-15R	<input type="checkbox"/> 5262CDLA	Lt. Almond	15A 125V	5-15R
<input type="checkbox"/> 5262CHBL	Blue	15A 125V	5-15R	<input type="checkbox"/> 5262CDBL	Blue	15A 125V	5-15R
<input type="checkbox"/> 5362CHI	Ivory	20A 125V	5-20R	<input type="checkbox"/> 5362CDI	Ivory	20A 125V	5-20R
<input type="checkbox"/> 5362CHW	White	20A 125V	5-20R	<input type="checkbox"/> 5362CDW	White	20A 125V	5-20R
<input type="checkbox"/> 5362CH	Brown	20A 125V	5-20R	<input type="checkbox"/> 5362CD	Brown	20A 125V	5-20R
<input type="checkbox"/> 5362CHGRY	Gray	20A 125V	5-20R	<input type="checkbox"/> 5362CDGRY	Gray	20A 125V	5-20R
<input type="checkbox"/> 5362CHBK	Black	20A 125V	5-20R	<input type="checkbox"/> 5362CDBK	Black	20A 125V	5-20R
<input type="checkbox"/> 5362CHGN	Green	20A 125V	5-20R	<input type="checkbox"/> 5362CDGN	Green	20A 125V	5-20R
<input type="checkbox"/> 5362CHLA	Lt. Almond	20A 125V	5-20R	<input type="checkbox"/> 5362CDLA	Lt. Almond	20A 125V	5-20R
<input type="checkbox"/> 5362CHBL	Blue	20A 125V	5-20R	<input type="checkbox"/> 5362CDBL	Blue	20A 125V	5-20R

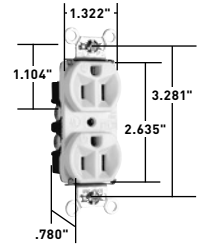

5262CDW

2 Pole, 3 Wire

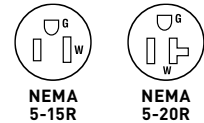

Performance

Electrical

Dielectric Voltage: Withstands 2000V minimum
 Maximum Working Voltage: 250V
 Current Interrupting: Certified for current interrupting at full-rated current
 Temperature Rise: Max 30°C temperature rise at full-rated current after 50 cycles of overload at 150% of rated current with direct current

Mechanical

Terminal Identification: Terminal Identification in accordance with UL498 (Brass, White, Green)
 Terminal Accommodation: #14 – #10 AWG copper conductor only
 Product Identification: Ratings are a permanent part of the device

Environmental

Flammability: UL94 V2
 Operating Temperature: Maximum continuous +60°C, minimum -40°C (without impact)

Materials

Face:	Nylon	Grounding Screw:	#8 Hex Tri-Drive Steel
Back Body:	PVC	Assembly Drive Screw:	Zinc-Plated Steel
Contacts:	.032" 688 Brass	Auto-Ground Clip:	Stainless Steel
Pressure Plate:	.080" Steel	Mounting Screws:	Tri-Drive Steel
Ground Contacts:	.040" 688 Brass	Ink:	Pad Printed
Mounting Strap:	.042" Zinc-Plated Steel		
Terminal Screws:	#8 Tri-Drive Steel (Neutral = Nickel-Plated Steel)		

Consult Straight Blade Section B for complete compliance listing.

Project
Location/Type

TECHNICAL SPECIFICATIONS

Construction Specification Grade Receptacles

Back & Side Wire 2 Pole, 3 Wire Grounding 15 & 20A, 125V

Typical Specifications

Manufacturer's Identification: Pass & Seymour® CRB5262

Description: Straight Blade Duplex Receptacle – Construction Specification Grade

Type: 2 Pole, 3 Wire Grounding

Rating: 15A, 125V

3rd Party Compliance: UL Listed, File Number E140596, Standard UL498, Federal Specification WC596.

CSA/CUL approved, File Number LR16063, Standard CSA-C22.2 No. 42. Conforms to NEMA WD-1 and WD-6.

CATALOG NUMBER	COLOR	RATING	NEMA CONFIG. NO.	CATALOG NUMBER	COLOR	RATING	NEMA CONFIG. NO.
<input type="checkbox"/> CRB5262I	Ivory	15A 125V	5-15R	<input type="checkbox"/> CRB5362I	Ivory	20A 125V	5-20R
<input type="checkbox"/> CRB5262W	White	15A 125V	5-15R	<input type="checkbox"/> CRB5362W	White	20A 125V	5-20R
<input type="checkbox"/> CRB5262	Brown	15A 125V	5-15R	<input type="checkbox"/> CRB5362	Brown	20A 125V	5-20R
<input type="checkbox"/> CRB5262GRY	Gray	15A 125V	5-15R	<input type="checkbox"/> CRB5362GRY	Gray	20A 125V	5-20R
<input type="checkbox"/> CRB5262BK	Black	15A 125V	5-15R	<input type="checkbox"/> CRB5362BK	Black	20A 125V	5-20R
<input type="checkbox"/> CRB5262RED	Red	15A 125V	5-15R	<input type="checkbox"/> CRB5362RED	Red	20A 125V	5-20R
<input type="checkbox"/> CRB5262LA	Lt. Almond	15A 125V	5-15R	<input type="checkbox"/> CRB5362LA	Lt. Almond	20A 125V	5-20R
<input type="checkbox"/> CRB5262SI	Ivory	15A 125V	5-15R	<input type="checkbox"/> CRB5362SI	Ivory	20A 125V	5-20R
<input type="checkbox"/> CRB5262SW	White	15A 125V	5-15R	<input type="checkbox"/> CRB5362SW	White	20A 125V	5-20R
<input type="checkbox"/> CRB5262SGRY	Gray	15A 125V	5-15R	<input type="checkbox"/> CRB5362S	Brown	20A 125V	5-20R
<input type="checkbox"/> CRB5262SRED	Red	15A 125V	5-15R	<input type="checkbox"/> CRB5362SGRY	Gray	20A 125V	5-20R
<input type="checkbox"/> CRB5262SLA	Lt. Almond	15A 125V	5-15R	<input type="checkbox"/> CRB5362SRED	Red	20A 125V	5-20R
				<input type="checkbox"/> CRB5362SLA	Lt. Almond	20A 125V	5-20R

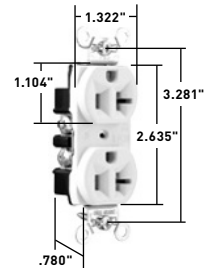

15 & 20 Amp

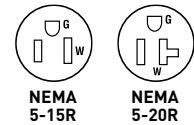

Performance

Electrical

- Dielectric Voltage: Withstands 2000V minimum
- Maximum Working Voltage: 250V
- Current Interrupting: Certified for current interrupting at full-rated current
- Temperature Rise: Max 30°C temperature rise at full-rated current after 50 cycles of overload at 150% of rated current with direct current

Mechanical

- Terminal Identification: Terminal Identification in accordance with UL498 (Brass, White, Green)
- Terminal Accommodation: #14 – #10 AWG copper conductor only
- Product Identification: Ratings are a permanent part of the device

Environmental

- Flammability: UL94 V2
- Operating Temperature: Maximum continuous +60°C, minimum -40°C (without impact)

Materials

- Face: Nylon
- Back Body: PVC
- Line Contacts: .032 688 Brass
- Mounting Strap: .042 Plated Steel
- Ground Contacts: .040 260 Brass
- Pressure Plate: .080 Steel
- Terminal Screws: #8 Tri-Drive Brass (Neutral = Nickel-Plated Steel)
- Ground Screw: #8 Hex Tri-Drive Steel with Green Zinc Coating
- Assembly Drive Screw: Zinc-Plated Steel
- Auto-Ground Clip: Stainless Steel
- Mounting Screws: Tri-Drive Steel

Consult Straight Blade Section B for complete compliance listing.

TECHNICAL SPECIFICATIONS

Project
Location/Type

TECHNICAL SPECIFICATIONS

Tamper-Resistant Hard Use & Commercial Specification Grade Receptacles

Back & Side Wire 2 Pole, 3 Wire Grounding 15 & 20A, 125V; 20A, 250V

Typical Specifications

Manufacturer's Identification: Pass & Seymour® CR15

Description: Straight Blade Duplex Receptacle – Commercial Specification Grade

Type: 2 Pole, 3 Wire Grounding

Rating: 15A, 125V

3rd Party Compliance: UL Listed, File Number E140596, Standard UL498, CSA Certified, File Number LR16063, Standard CSA-C22.2 No. 42. Conforms to NEMA WD-1 and WD-6.

CATALOG NUMBER	COLOR	RATING	NEMA CONFIG. NO.	CATALOG NUMBER	COLOR	RATING	NEMA CONFIG. NO.
<input type="checkbox"/> CR15I	Ivory	15A 125V	5-15R	<input type="checkbox"/> CR20I	Ivory	20A 125V	5-20R
<input type="checkbox"/> CR15W	White	15A 125V	5-15R	<input type="checkbox"/> CR20W	White	20A 125V	5-20R
<input type="checkbox"/> CR15	Brown	15A 125V	5-15R	<input type="checkbox"/> CR20	Brown	20A 125V	5-20R
<input type="checkbox"/> CR15GRY	Gray	15A 125V	5-15R	<input type="checkbox"/> CR20GRY	Gray	20A 125V	5-20R
<input type="checkbox"/> CR15LA	Lt. Almond	15A 125V	5-15R	<input type="checkbox"/> CR20BK	Black	20A 125V	5-20R
				<input type="checkbox"/> CR20RED	Red	20A 125V	5-20R
				<input type="checkbox"/> CR20LA	Lt. Almond	20A 125V	5-20R
				<input type="checkbox"/> 5850I*	Ivory	20A 250V	6-20R
				<input type="checkbox"/> 5850W*	White	20A 250V	6-20R

*Side wire only

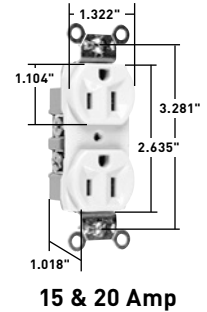

Performance

Electrical

- Dielectric Voltage: Withstands 1500V minimum
- Maximum Working Voltage: 125V
- Maximum Continuous Current: 15A – CR15/BR15; 20A – CR20/BR20/5850
- Temperature Rise: Maximum 30°C after 50 cycles at 150% of rated current

Mechanical

- Terminal Accommodation: #14 – #10 AWG
- Product Identification: Amp, Voltage, 3rd Party Compliance

Environmental

- Flammability: UL94 V2
- Operating Temperature: Maximum continuous +50°C, minimum -40°C without impact

Materials

- Face: Nylon
- Back Body: PVC
- Line Contacts: .032 688 Brass
- Mounting Strap: .042 Plated Steel
- Ground Contacts: .040 260 Brass
- Terminal Screws: #8 Tri-Drive Steel (Neutral = Nickel-Plated Steel)
- Ground Screw: #8 Hex Tri-Drive Steel with Green Zinc Coating
- Assembly Drive Screw: Zinc-Plated Steel
- Auto-Ground Clip: Stainless Steel
- Mounting Screws: Tri-Drive Steel

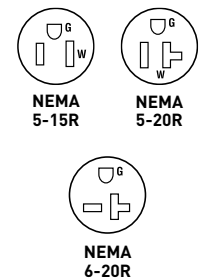

Consult Straight Blade Section B for complete compliance listing.

Project
Location/Type

TECHNICAL SPECIFICATIONS

Tamper-Resistant Specification & Hospital Grade Receptacles

Back & Side Wire 2 Pole, 3 Wire Grounding 15 & 20A, 125

Typical Specifications

Manufacturer's Identification: Pass & Seymour® TR62
 Description: Straight Blade Duplex Receptacle – Tamper-Resistant Specification & Hospital Grade
 Type: 2 Pole, 3 Wire Grounding
 Rating: 15A, 125V
 Configuration: NEMA 5-15R
 3rd Party Compliance: UL Listed, File Number E140596, Standard UL498, Federal Specification WC596.
 CSA Certified, File Number LR16063, Standard CSA-C22.2 No. 42. Conforms to NEMA WD-1 and WD-6.

CATALOG NUMBER	COLOR	RATING	NEMA CONFIG. NO.	CATALOG NUMBER	COLOR	RATING	NEMA CONFIG. NO.
<input type="checkbox"/> TR62I	Ivory	15A 125V	5-15R	<input type="checkbox"/> TR62HI	Ivory	15A 125V	5-15R
<input type="checkbox"/> TR62W	White	15A 125V	5-15R	<input type="checkbox"/> TR62HW	White	15A 125V	5-15R
<input type="checkbox"/> TR62	Brown	15A 125V	5-15R	<input type="checkbox"/> TR62H	Brown	15A 125V	5-15R
<input type="checkbox"/> TR62GRY	Gray	15A 125V	5-15R	<input type="checkbox"/> TR62HGRY	Gray	15A 125V	5-15R
<input type="checkbox"/> TR62LA	Lt. Almond	15A 125V	5-15R	<input type="checkbox"/> TR62HRED	Red	15A 125V	5-15R
<input type="checkbox"/> TR63I	Ivory	20A 125V	5-20R	<input type="checkbox"/> TR62HLA	Lt. Almond	15A 125V	5-15R
<input type="checkbox"/> TR63W	White	20A 125V	5-20R	<input type="checkbox"/> TR63HI	Ivory	20A 125V	5-20R
<input type="checkbox"/> TR63	Brown	20A 125V	5-20R	<input type="checkbox"/> TR63HW	White	20A 125V	5-20R
<input type="checkbox"/> TR63GRY	Gray	20A 125V	5-20R	<input type="checkbox"/> TR63H	Brown	20A 125V	5-20R
<input type="checkbox"/> TR63BK	Black	20A 125V	5-20R	<input type="checkbox"/> TR63HGRY	Gray	20A 125V	5-20R
<input type="checkbox"/> TR63RED	Red	20A 125V	5-20R	<input type="checkbox"/> TR63HRED	Red	20A 125V	5-20R
<input type="checkbox"/> TR63LA	Lt. Almond	20A 125V	5-20R	<input type="checkbox"/> TR63HLA	Lt. Almond	20A 125V	5-20R
<input type="checkbox"/> TR63BL	Blue	20A 125V	5-20R	<input type="checkbox"/> TR63HBL	Blue	20A 125V	5-20R

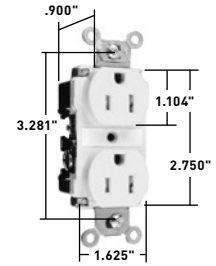

TR62I

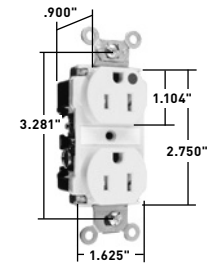

TR62HI

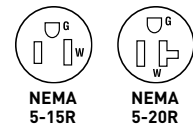

Performance

Electrical

Dielectric Voltage: Withstands 2000V minimum
 Maximum Working Voltage: 250V
 Current Interrupting: Certified for current interrupting at full-rated current
 Temperature Rise: Maximum 30°C temperature rise at full-rated current after 50 cycles of overload at 150% of rated current with direct current

Mechanical

Terminal Identification: Terminal Identification in accordance with UL498 (Brass, White, Green)
 Terminal Accommodation: #14 – #10 AWG copper conductor only
 Product Identification: Ratings are a permanent part of the device

Environmental

Flammability: UL94 V2
 Operating Temperature: Maximum continuous +60°C, minimum -40°C without impact

Materials

Face:	Nylon	Terminal Screws:	#10 Tri-Drive Brass
Back Body:	Nylon		(Neutral = Nickel-Plated Steel)
Line Contacts:	.036 688 Brass	Ground Screw:	#10 Hex Tri-Drive Brass
Mounting Strap:	.050 688 Brass	Assembly Drive Screw:	Zinc-Plated Steel
Ground Contacts:	Strap with Integral Ground	Auto-Ground Clip:	Brass
Pressure Plate:	.031 260 Brass	Mounting Screws:	Tri-Drive Steel
Tamper Shutter:	Thermoplastic		

Consult Straight Blade Section B for complete compliance listing.

TECHNICAL SPECIFICATIONS

Project
Location/Type

TECHNICAL SPECIFICATIONS

Tamper-Resistant Hard Use Receptacles

2 Pole, 3 Wire Grounding 15 & 20A, 125V

Typical Specifications

Manufacturer's Identification: Pass & Seymour® TR5262

Description: Straight Blade Duplex Receptacle – Tamper-Resistant Hard Use

Type: 2 Pole, 3 Wire Grounding

Rating: 15A, 125V

Configuration: NEMA 5-15R

3rd Party Compliance: UL Listed, File Number E140596, Standard UL498, Federal Specification WC596, CSA/CUL Approved, Standard CSA-C22.2 No. 42. Conforms to NEMA WD-1 and WD-6.

CATALOG NUMBER	COLOR	RATING	NEMA CONFIG. NO.	CATALOG NUMBER	COLOR	RATING	NEMA CONFIG. NO.
<input type="checkbox"/> TR5262I	Ivory	15A 125V	5-15R	<input type="checkbox"/> TR5362I	Ivory	20A 125V	5-20R
<input type="checkbox"/> TR5262W	White	15A 125V	5-15R	<input type="checkbox"/> TR5362W	White	20A 125V	5-20R
<input type="checkbox"/> TR5262	Brown	15A 125V	5-15R	<input type="checkbox"/> TR5362	Brown	20A 125V	5-20R
<input type="checkbox"/> TR5262GRY	Gray	15A 125V	5-15R	<input type="checkbox"/> TR5362GRY	Gray	20A 125V	5-20R
<input type="checkbox"/> TR5262BKK	Black	15A 125V	5-15R	<input type="checkbox"/> TR5362BKK	Black	20A 125V	5-20R
<input type="checkbox"/> TR5262RED	Red	15A 125V	5-15R	<input type="checkbox"/> TR5362RED	Red	20A 125V	5-20R
<input type="checkbox"/> TR5262LA	Lt. Almond	15A 125V	5-15R	<input type="checkbox"/> TR5362LA	Lt. Almond	20A 125V	5-20R

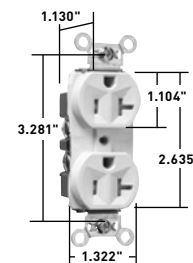

TR5362LA

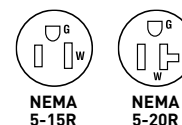

Performance

Electrical

Dielectric Voltage: Withstands 2000V minimum

Maximum Working Voltage: 125V

Maximum Continuous Current: TR5262 = 15A, TR5263 = 20A

Temperature Rise: Maximum 30°C temperature rise at full-rated current after 50 cycles of overload at 150% of rated current with direct current

Mechanical

Terminal Accommodation: #14 – #10 AWG copper conductor only

Product Identification: Amperage, Voltage, 3rd Party Compliance

Environmental

Flammability: UL94 V2

Operating Temperature: Maximum continuous +60°C, minimum -40°C without impact

Materials

Face: Nylon

Back Body: PVC

Line Contacts: .036 Olin 688 Brass

Mounting Strap: .042 Zinc-Plated Steel

Ground Contacts: .040 Olin 688 Brass

Pressure Plate: .080 Steel

Tamper-Resistant Shutters: Thermoplastic

Terminal Screws: #10 Tri-Drive Brass

(Neutral = Nickel-Plated Steel)

Ground Screw: #8 Hex Tri-Drive Steel;

Zinc Coating with Green Chromate

Assembly Drive Screw: Zinc-Plated Steel

Auto-Ground Clip: Stainless Steel

Mounting Screws: Tri-Drive Steel

Consult Straight Blade Section B for complete compliance listing.

Project
Location/Type

TECHNICAL SPECIFICATIONS

Tamper-Resistant Commercial Grade Receptacles

2 Pole, 3 Wire Grounding 15 & 20A, 125V

Typical Specifications

Manufacturer's Identification: Pass & Seymour® TR15
 Description: Straight Blade Duplex Receptacle – Tamper-Resistant Commercial Grade
 Type: 2 Pole, 3 Wire Grounding
 Rating: 15A, 125V
 Configuration: NEMA 5-15R
 3rd Party Compliance: UL Listed, File Number E140596, Standard UL498, CSA/CUL Approved, Standard CSA-C22.2 No. 42.
 Conforms to NEMA WD-1 and WD-6.

CATALOG NUMBER	COLOR	RATING	NEMA CONFIG. NO.	CATALOG NUMBER	COLOR	RATING	NEMA CONFIG. NO.
<input type="checkbox"/> TR15I	Ivory	15A 125V	5-15R	<input type="checkbox"/> TR5252I	Ivory	15A 125V	5-15R
<input type="checkbox"/> TR15W	White	15A 125V	5-15R	<input type="checkbox"/> TR5252W	White	15A 125V	5-15R
<input type="checkbox"/> TR15	Brown	15A 125V	5-15R	<input type="checkbox"/> TR5252	Brown	15A 125V	5-15R
<input type="checkbox"/> TR15GRY	Gray	15A 125V	5-15R	<input type="checkbox"/> TR5252GRY	Gray	15A 125V	5-15R
<input type="checkbox"/> TR15BK	Black	15A 125V	5-15R	<input type="checkbox"/> TR5252BK	Black	15A 125V	5-15R
<input type="checkbox"/> TR15LA	Lt. Almond	15A 125V	5-15R	<input type="checkbox"/> TR5252LA	Lt. Almond	15A 125V	5-15R
<input type="checkbox"/> TR20I	Ivory	20A 125V	5-20R	<input type="checkbox"/> TR5352I	Ivory	20A 125V	5-20R
<input type="checkbox"/> TR20W	White	20A 125V	5-20R	<input type="checkbox"/> TR5352W	White	20A 125V	5-20R
<input type="checkbox"/> TR20	Brown	20A 125V	5-20R	<input type="checkbox"/> TR5352	Brown	20A 125V	5-20R
<input type="checkbox"/> TR20GRY	Gray	20A 125V	5-20R	<input type="checkbox"/> TR5352GRY	Gray	20A 125V	5-20R
<input type="checkbox"/> TR20BK	Black	20A 125V	5-20R	<input type="checkbox"/> TR5352BK	Black	20A 125V	5-20R
<input type="checkbox"/> TR20LA	Lt. Almond	20A 125V	5-20R	<input type="checkbox"/> TR5352LA	Lt. Almond	20A 125V	5-20R

Performance

Electrical

Dielectric Withstand Voltage	Withstands 2000V minimum
Maximum Working Voltage	250V
Current Interrupting	Certified for current interrupting at full-rated current
Temperature Rise	Maximum 30°C temperature rise at full-rated current after 50 cycles of overload at 150% of rated current with direct current

Mechanical

Terminal Identification	Terminal Identification in accordance with UL 498, (Brass, White, Green)
Terminal Accommodation	#14 AWG - #10 AWG copper conductor only.
Product Identification	Ratings are permanent part of the device

Environmental

Flammability	UL94 V2
Operating Temperature	Maximum continuous +60°C, minimum -40°C without impact

Materials

Face	Nylon	Terminal Screws	#8 Tri-Drive Steel (Neutral = Nickel-Plated Steel)
Back Body	Nylon	Ground Screw	#8 Hex Tri-Drive Steel; Zinc Coating with Green Chromate
Line Contacts	.032 260 Brass	Auto-Ground Clip	Stainless Steel
Mounting Strap	.042 Zinc-Plated Steel	Mounting Screws	Tri-Drive Steel
Ground Contacts	.040 260 Brass		
Pressure Plate	.080 Steel		
Tamper-Resistant Shutters	Thermoplastic		

Consult Straight Blade Section B for complete compliance listing.

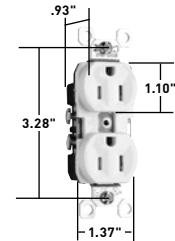

TR15LA

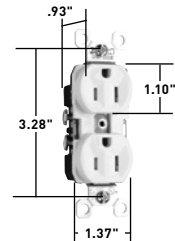

TR5252W

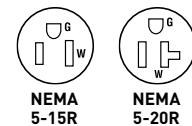

NEMA 5-15R

NEMA 5-20R

Project
Location/Type

TECHNICAL SPECIFICATIONS

Tamper-Resistant Construction & Hospital Grade Single Receptacles

2 Pole, 3 Wire Grounding 15 & 20A, 125V

Typical Specifications

Manufacturer's Identification: Pass & Seymour® TR5251

Description: Straight Blade Single Receptacle – Tamper-Resistant Construction Grade and Hospital Grade

Type: 2 Pole, 3 Wire Grounding

Rating: 15A, 125V

Configuration: NEMA 5-15R

3rd Party Compliance: UL Listed, File Number E140596, Standard UL498, Federal Specification WC596, CSA Certified, Standard CSA-C22.2 No. 42. Conforms to NEMA WD-1 and WD-6.

Tamper-Resistant Construction Grade Single Receptacles

CATALOG NUMBER	COLOR	RATING	NEMA CONFIG. NO.	CATALOG NUMBER	COLOR	RATING	NEMA CONFIG. NO.
<input type="checkbox"/> TR5251I	Ivory	15A 125V	5-15R	<input type="checkbox"/> TR5351I	Ivory	20A 125V	5-20R
<input type="checkbox"/> TR5251W	White	15A 125V	5-15R	<input type="checkbox"/> TR5351W	White	20A 125V	5-20R
<input type="checkbox"/> TR5251	Brown	15A 125V	5-15R	<input type="checkbox"/> TR5351	Brown	20A 125V	5-20R
<input type="checkbox"/> TR5251LA	Lt. Almond	15A 125V	5-15R	<input type="checkbox"/> TR5351LA	Lt. Almond	20A 125V	5-20R

Tamper-Resistant Hospital Grade Single Receptacles

CATALOG NUMBER	COLOR	RATING	NEMA CONFIG. NO.	CATALOG NUMBER	COLOR	RATING	NEMA CONFIG. NO.
<input type="checkbox"/> TR8201I	Ivory	15A 125V	5-15R	<input type="checkbox"/> TR8301I	Ivory	20A 125V	5-20R
<input type="checkbox"/> TR8201W	White	15A 125V	5-15R	<input type="checkbox"/> TR8301W	White	20A 125V	5-20R
<input type="checkbox"/> TR8201	Brown	15A 125V	5-15R	<input type="checkbox"/> TR8301	Brown	20A 125V	5-20R
<input type="checkbox"/> TR8201GRY	Gray	15A 125V	5-15R	<input type="checkbox"/> TR8301BK	Black	20A 125V	5-20R
<input type="checkbox"/> TR8201BK	Black	15A 125V	5-15R	<input type="checkbox"/> TR8301RED	Red	20A 125V	5-20R
<input type="checkbox"/> TR8201RED	Red	15A 125V	5-15R	<input type="checkbox"/> TR8301LA	Lt. Almond	20A 125V	5-20R
<input type="checkbox"/> TR8201LA	Lt. Almond	15A 125V	5-15R				

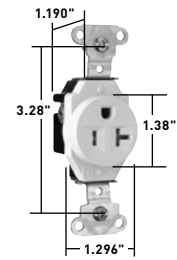

TR5351LA

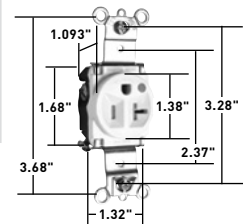

TR8301LA

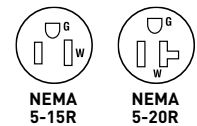

Performance

Electrical

Dielectric Voltage: Withstands 2000V minimum

Maximum Working Voltage: 125V

Current Interrupting: Certified for current interrupting at full-rated current

Temperature Rise: Maximum 30°C temperature rise at full-rated current after 50 cycles of overload at 150% of rated current with direct current

Mechanical

Terminal Identification: Terminal identification in accordance with UL498 (Brass, White, Green)

Terminal Accommodation: #14 – #10 AWG copper conductor only

Product Identification: Ratings are a permanent part of the device

Environmental

Flammability: UL94 V2

Materials

Face: Nylon

Back Body: PVC

Contacts: .032" (.8) Brass

Clamping Plate: .080" Steel

Mounting Strap: .042" Steel

Tamper-Resistant Shutters: Thermoplastic

Terminal Screws: Tri-Drive Brass

Hex Head Grounding Screw: Tri-Drive Zinc-Plated Steel

Assembly Rivets: Steel

Mounting Screws: Tri-Drive Steel

Consult Straight Blade Section B for complete compliance listing.

Project
Location/Type

TECHNICAL SPECIFICATIONS

Weather-Resistant Heavy-Duty Receptacles 2 Pole, 3 Wire Grounding 15 & 20A, 125 & 250V

Typical Specifications

Manufacturer's Identification: Pass & Seymour® WR5262
 Description: Straight Blade Duplex Receptacle – Weather-Resistant Heavy-Duty
 Type: 2 Pole, 3 Wire Grounding
 Rating: 15A, 125V
 Configuration: NEMA 5-15R
 3rd Party Compliance: UL Listed, File Number E140596, Standard UL498, Federal Specification WC596, CSA Certified, File Number LR16063, Standard CSA-C22.2 No. 42. Conforms to NEMA WD-1 and WD-6.

CATALOG NUMBER	COLOR	RATING	NEMA CONFIG. NO.	CATALOG NUMBER	COLOR	RATING	NEMA CONFIG. NO.
<input type="checkbox"/> WR5262I	Ivory	15A 125V	5-15R	<input type="checkbox"/> WR5662I	Ivory	15A 250V	6-15R
<input type="checkbox"/> WR5262W	White	15A 125V	5-15R	<input type="checkbox"/> WR5662GRY	Gray	15A 250V	6-15R
<input type="checkbox"/> WR5262GRY	Gray	15A 125V	5-15R	<input type="checkbox"/> WR5862I	Ivory	20A 250V	6-20R
<input type="checkbox"/> WR5362I	Ivory	20A 125V	5-20R	<input type="checkbox"/> WR5862W	White	20A 250V	6-20R
<input type="checkbox"/> WR5362W	White	20A 125V	5-20R	<input type="checkbox"/> WR5862GRY	Gray	20A 250V	6-20R
<input type="checkbox"/> WR5362GRY	Gray	20A 125V	5-20R				

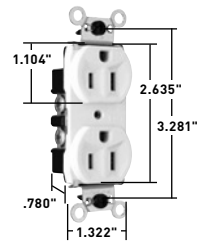

WR5262W

Performance

Electrical

Dielectric Voltage: Withstands 2000V minimum
 Maximum Working Voltage: 125V/250V
 Current Interrupting: Certified for current interrupting at full-rated current
 Temperature Rise: Maximum 30°C temperature rise at full-rated current after 50 cycles of overload at 150% of rated current with direct current

Mechanical

Terminal Identification: Terminal identification in accordance with UL498 (Brass, White, Green)
 Terminal Accommodation: #14 – #10 AWG copper conductor only
 Product Identification: Ratings are a permanent part of the device

Environmental

Flammability: UL94 V2
 Operating Temperature: Maximum continuous +60°C, minimum -40°C without impact

Materials

Face:	UV Resistant Nylon	Ground Screw:	#8 Hex Tri-Drive Nickel-Plated Steel
Back Body:	PVC	Assembly Drive Screw:	.0004" Zinc-Plated Steel
Line Contacts:	.032 688 Brass	Auto-Ground Clip:	Stainless Steel
Mounting Strap:	.043 260 Brass	Mounting Screws:	Tri-Drive Steel .0004" Zinc-Plated Steel
Ground Contact:	.040 688 Brass		
Pressure Plate:	.080 Nickel-Plated Steel		
Terminal Screws:	#8 Tri-Drive Steel (Neutral = Nickel-Plated Steel)		

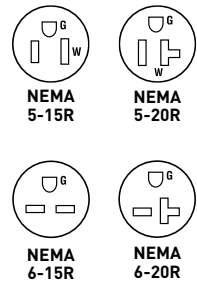

TECHNICAL SPECIFICATIONS

Consult Straight Blade Section B for complete compliance listing.

Project
Location/Type

TECHNICAL SPECIFICATIONS

Weather-Resistant Commercial Grade Receptacles 2 Pole, 3 Wire Grounding 20A, 125V

Typical Specifications

Manufacturer's Identification: Pass & Seymour® WR20TR

Description: Straight Blade Duplex Receptacle – Weather-Resistant Commercial Grade

Type: 2 Pole, 3 Wire Grounding

Rating: 20A, 125V

Configuration: NEMA 5-20R

3rd Party Compliance: cUL Listed, File Number E140596, Standard UL498, Standard CSA-C22.2 No. 42.

Conforms to NEMA WD-1 and WD-6.

CATALOG NUMBER	COLOR	RATING	NEMA CONFIG. NO.	CATALOG NUMBER	COLOR	RATING	NEMA CONFIG. NO.
<input type="checkbox"/> WR20TRI	Ivory	20A 125V	5-20R	<input type="checkbox"/> WR20TRGRY	Gray	20A 125V	5-20R
<input type="checkbox"/> WR20TRW	White	20A 125V	5-20R	<input type="checkbox"/> WR20TRLA	Lt. Almond	20A 125V	5-20R
<input type="checkbox"/> WR20TR	Brown	20A 125V	5-20R				

WR20TR models are Tamper-Resistant.

Performance

Electrical

Dielectric Voltage: Withstands 1500V minimum

Maximum Working Voltage: 125V

Temperature Rise: Maximum 30°C temperature rise at full-rated current after 50 cycles of overload at 150% of rated current with direct current

Mechanical

Terminal Identification: Terminal identification in accordance with UL498 (Brass, White, Green)

Terminal Accommodation: #14 – #10 AWG copper conductor only

Product Identification: Ratings are a permanent part of the device

Environmental

Flammability: UL94 V2

Operating Temperature: Maximum continuous +50°C, minimum -40°C without impact

Materials

Face: UV Resistant Nylon

Back Body: PVC

Line Contacts: .032 260 Brass

Mounting Strap: .042 Nickel-Plated Steel

Ground Contact: .040 260 Brass

Terminal Screws: #8 Tri-Drive Brass
(Neutral = Nickel-Plated Brass)

Ground Screw: #8 Hex Tri-Drive
Nickel-Plated Steel

Assembly Drive Screw: Zinc-Plated Steel

Auto-Ground Clip: Stainless Steel

Mounting Screws: Tri-Drive Steel

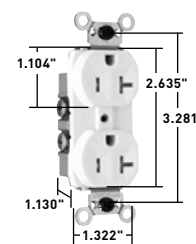

WR20TRW



NEMA
5-20R

Consult Straight Blade Section B for complete compliance listing.

Project

Location/Type



TECHNICAL SPECIFICATIONS

PlugTail® Decorator Receptacles 2 Pole, 3 Wire Grounding 15 & 20A, 125V

Typical Specifications

Manufacturer's Identification: Pass & Seymour® PT26252
 Description: PlugTail® Straight Blade Duplex Receptacle – Decorator Specification Grade
 Type: 2 Pole, 3 Wire Grounding
 Rating: 15A, 125V
 Configuration: NEMA 5-15R
 3rd Party Compliance: cULus Listed, File Number E140596, Standard UL498. Federal Specification WC596.
 Conforms to NEMA WD-1 and WD-6.

CATALOG NUMBER	COLOR	RATING	NEMA CONFIG. NO.	CATALOG NUMBER	COLOR	RATING	NEMA CONFIG. NO.
<input type="checkbox"/> PT26252W	White	15A 125V	5-15R	<input type="checkbox"/> PT26362HGI	Ivory	20A 125V	5-20R
<input type="checkbox"/> PT26252	Brown	15A 125V	5-15R	<input type="checkbox"/> PT26362HWG	White	20A 125V	5-20R
<input type="checkbox"/> PT26252GRY	Gray	15A 125V	5-15R	<input type="checkbox"/> PT26362HGGRY	Gray	20A 125V	5-20R
<input type="checkbox"/> PT26252BK	Black	15A 125V	5-15R	<input type="checkbox"/> PT26362HGRED	Red	20A 125V	5-20R
<input type="checkbox"/> PT26252RED	Red	15A 125V	5-15R	<input type="checkbox"/> PT26362HGLA	Lt. Almond	20A 125V	5-20R
<input type="checkbox"/> PT26252LA	Lt. Almond	15A 125V	5-15R	<input type="checkbox"/> PTIG26262W	White	15A 125V	5-15R
<input type="checkbox"/> PT26352I	Ivory	20A 125V	5-20R	<input type="checkbox"/> PTIG26262	Orange	15A 125V	5-15R
<input type="checkbox"/> PT26352W	White	20A 125V	5-20R	<input type="checkbox"/> PTIG26262RED	Red	15A 125V	5-15R
<input type="checkbox"/> PT26352	Brown	20A 125V	5-20R	<input type="checkbox"/> PTIG26362I	Ivory	20A 125V	5-20R
<input type="checkbox"/> PT26352GRY	Gray	20A 125V	5-20R	<input type="checkbox"/> PTIG26362W	White	20A 125V	5-20R
<input type="checkbox"/> PT26352BK	Black	20A 125V	5-20R	<input type="checkbox"/> PTIG26362	Orange	20A 125V	5-20R
<input type="checkbox"/> PT26352RED	Red	20A 125V	5-20R	<input type="checkbox"/> PTIG26362GRY	Gray	20A 125V	5-20R
<input type="checkbox"/> PT26352LA	Lt. Almond	20A 125V	5-20R				
<input type="checkbox"/> PT26352BL	Blue	20A 125V	5-15R				
<input type="checkbox"/> PT26262HGI	Ivory	15A 125V	5-15R				
<input type="checkbox"/> PT26262HWG	White	15A 125V	5-15R				
<input type="checkbox"/> PT26262HGRED	Red	15A 125V	5-15R				

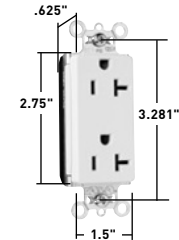

PT26352LA

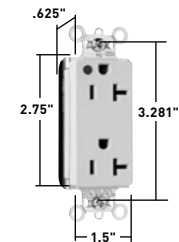

PT26362HGI

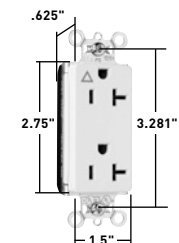

PTIG26362LA

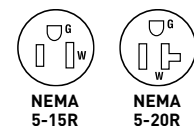

Performance

Electrical

Dielectric Voltage: Withstands 2000V minimum
 Maximum Working Voltage: 125V
 Current Interrupting: Certified for current interrupting at full-rated current (receptacle only)
 Temperature Rise: Maximum 30°C temperature rise at full-rated current after 50 cycles of overload at 150% of rated current with direct current

Mechanical

PlugTail Connector Identification: #12 AWG, THHN, copper conductor, 6" leads, stripped, solid or stranded, for use with PlugTail Receptacles only
 Product Identification: Ratings are a permanent part of the device

Environmental

Flammability: UL94 V2
 Operating Temperature: Maximum continuous +60°C, minimum -40°C without impact

PlugTail Receptacle Materials

Face:	Nylon	Integral Ground System:	.036 260 Brass
Back Body:	PVC	Assembly Drive Screw:	Plated Steel
Line Contacts:	.036 688 Brass	Auto-Ground Clip:	Steel
Mounting Strap:	.042 Plated Steel	Mounting Screws:	Tri-Drive Steel

PlugTail Connector Materials

Housing: Polycarbonate Contacts: .030 Brass

Consult Straight Blade Section B for complete compliance listing.

TECHNICAL SPECIFICATIONS

Project
Location/Type

TECHNICAL SPECIFICATIONS

PlugTail® Tamper-Resistant Duplex Receptacles 15 & 20A, 125V

Typical Specifications

Manufacturer's Identification: Pass & Seymour® PTTR26262

Description: PlugTail® Tamper-Resistant Straight Blade Duplex Receptacle

Type: 2 Pole, 3 Wire Grounding

Rating: 15A, 125V

Configuration: NEMA 5-15R

3rd Party Compliance: cULus Listed, File Number E140596, Standard UL498. Federal Specification WC596. Conforms to NEMA WD-1 and WD-6.

CATALOG NUMBER	COLOR	RATING	NEMA CONFIG. NO.	CATALOG NUMBER	COLOR	RATING	NEMA CONFIG. NO.
<input type="checkbox"/> PTTR26262W	White	15A 125V	5-15R	<input type="checkbox"/> PTTR26362I	Ivory	20A 125V	5-20R
<input type="checkbox"/> PTTR26262	Brown	15A 125V	5-15R	<input type="checkbox"/> PTTR26362W	White	20A 125V	5-20R
<input type="checkbox"/> PTTR26262BK	Black	15A 125V	5-15R	<input type="checkbox"/> PTTR26362I	Brown	20A 125V	5-20R
<input type="checkbox"/> PTTR26262LA	Lt. Almond	15A 125V	5-15R	<input type="checkbox"/> PTTR26362BK	Black	20A 125V	5-20R
				<input type="checkbox"/> PTTR26362LA	Lt. Almond	20A 125V	5-20R

Performance

Electrical

Dielectric Voltage: Withstands 2000V minimum

Maximum Working Voltage: 125V

Current Interrupting: Certified for current interrupting at full-rated current (receptacle only)

Temperature Rise: Maximum 30°C temperature rise at full-rated current after 50 cycles of overload at 150% of rated current with direct current

Mechanical

PlugTail Connector Identification: #12 AWG, THHN, copper conductor, 6" leads, stripped, solid or stranded, for use with PlugTail Receptacles only

Product Identification: Ratings are a permanent part of the device

Environmental

Flammability: UL94 V2

Operating Temperature: Maximum continuous +60°C, minimum -40°C without impact

Tamper-Resistant Duplex Receptacle Materials

Face: Nylon Integral Ground System: .036 260 Brass

Back Body: PVC Assembly Drive Screw: Plated Steel

Line Contacts: .036 688 Brass Auto-Ground Clip: Steel

Mounting Strap: .042 Plated Steel Mounting Screws: Tri-Drive Steel

Tamper-Resistant Duplex Connector Materials

Housing: Polycarbonate Contacts: .030 Brass

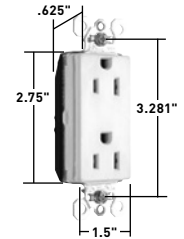

PTTR26262W

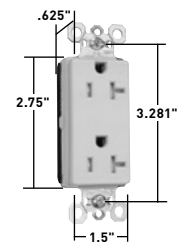

PTTR26362I

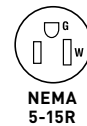

NEMA
5-15R

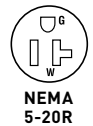

NEMA
5-20R

Consult Straight Blade Section B for complete compliance listing.

Project
Location/Type

TECHNICAL SPECIFICATIONS

PlugTail® Tamper-Resistant Hospital Grade Duplex Receptacles 15 & 20A, 125V

Typical Specifications

Manufacturer's Identification: Pass & Seymour® PTTR26262HG
 Description: PlugTail® Tamper-Resistant Straight Blade Duplex Receptacle – Hospital Grade
 Type: 2 Pole, 3 Wire Grounding
 Rating: 15A, 125V
 Configuration: NEMA 5-15R
 3rd Party Compliance: cULus Listed, File Number E140596, Standard UL498. Federal Specification WC596. Conforms to NEMA WD-1 and WD-6.

CATALOG NUMBER	COLOR	RATING	NEMA CONFIG. NO.	CATALOG NUMBER	COLOR	RATING	NEMA CONFIG. NO.
<input type="checkbox"/> PTTR26262HG	Ivory	15A 125V	5-15R	<input type="checkbox"/> PTTR26362HGI	Ivory	20A 125V	5-20R
<input type="checkbox"/> PTTR26262HGW	White	15A 125V	5-15R	<input type="checkbox"/> PTTR26362HGW	White	20A 125V	5-20R
<input type="checkbox"/> PTTR26262HGRE	Red	15A 125V	5-15R	<input type="checkbox"/> PTTR26362HGGY	Gray	20A 125V	5-20R
				<input type="checkbox"/> PTTR26362HGRE	Red	20A 125V	5-20R
				<input type="checkbox"/> PTTR26362HGLA	Lt. Almond	20A 125V	5-20R

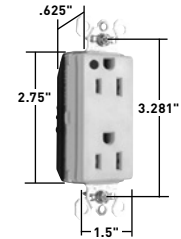

PTTR26262HGI

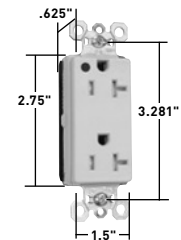

PTTR26362HGI

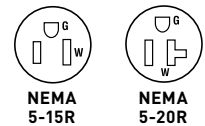

Electrical

Dielectric Voltage: Withstands 2000V minimum
 Maximum Working Voltage: 125V
 Current Interrupting: Certified for current interrupting at full-rated current (receptacle only)
 Temperature Rise: Maximum 30°C temperature rise at full-rated current after 50 cycles of overload at 150% of rated current with direct current

Mechanical

PlugTail Connector Identification: #12 AWG, THHN, copper conductor, 6" leads, stripped, solid or stranded, for use with PlugTail Receptacles only

Product Identification: Ratings are a permanent part of the device

Environmental

Flammability: UL94 V2
 Operating Temperature: Maximum continuous +60°C, minimum -40°C without impact

Tamper-Resistant Duplex Receptacle Materials

Face:	Nylon	Integral Ground System:	.036 260 Brass
Back Body:	PVC	Assembly Drive Screw:	Plated Steel
Line Contacts:	.036 688 Brass	Auto-Ground Clip:	Steel
Mounting Strap:	.042 Plated Steel	Mounting Screws:	Tri-Drive Steel

Tamper-Resistant Duplex Connector Materials

Housing:	Polycarbonate	Contacts:	.030 Brass
----------	---------------	-----------	------------

Consult Straight Blade Section B for complete compliance listing.

TECHNICAL SPECIFICATIONS

Project
Location/Type

TECHNICAL SPECIFICATIONS

PlugTail® Tamper-Resistant Split Circuit Duplex Receptacles 15 & 20A, 125V

Typical Specifications

Manufacturer's Identification: Pass & Seymour® PTTR26262SC
 Description: PlugTail® Tamper-Resistant Straight Blade Duplex Receptacle – Split Circuit
 Type: 2 Pole, 3 Wire Grounding
 Rating: 15A, 125V
 Configuration: NEMA 5-15R
 3rd Party Compliance: cULus Listed, File Number E140596, Standard UL498. Federal Specification WC596. Conforms to NEMA WD-1 and WD-6.

CATALOG NUMBER	COLOR	RATING	NEMA CONFIG. NO.	CATALOG NUMBER	COLOR	RATING	NEMA CONFIG. NO.
<input type="checkbox"/> PTTR26262SCI	Ivory	15A 125V	5-15R	<input type="checkbox"/> PTTR26362SCW	White	20A 125V	5-20R
<input type="checkbox"/> PTTR26262SCW	White	15A 125V	5-15R	<input type="checkbox"/> PTTR26362SC	Brown	20A 125V	5-20R
<input type="checkbox"/> PTTR26262SCBK	Black	15A 125V	5-15R	<input type="checkbox"/> PTTR26362SCLA	Lt. Almond	20A 125V	5-20R

Performance

Electrical

Dielectric Voltage: Withstands 2000V minimum
 Maximum Working Voltage: 125V
 Current Interrupting: Certified for current interrupting at full-rated current (receptacle only)
 Temperature Rise: Maximum 30°C temperature rise at full-rated current after 50 cycles of overload at 150% of rated current with direct current

Mechanical

PlugTail Connector Identification: #12 AWG, THHN, copper conductor, 6" leads, stripped, solid or stranded, for use with PlugTail Receptacles only
 Product Identification: Ratings are a permanent part of the device

Environmental

Flammability: UL94 V2
 Operating Temperature: Maximum continuous +60°C, minimum -40°C without impact

Tamper-Resistant Duplex Receptacle Materials

Face: Nylon
 Back Body: PVC
 Line Contacts: .036 688 Brass
 Mounting Strap: .042 Plated Steel
 Integral Ground System: .036 260 Brass
 Assembly Drive Screw: Plated Steel
 Auto-Ground Clip: Steel
 Mounting Screws: Tri-Drive Steel

Tamper-Resistant Duplex Connector Materials

Housing: Polycarbonate
 Contacts: .030 Brass

Consult Straight Blade Section B for complete compliance listing.

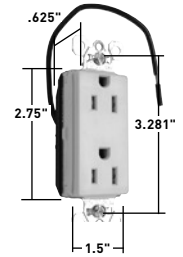

PTTR26262SCI

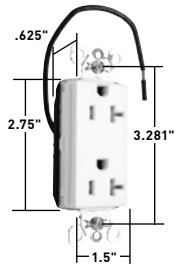

PTTR26362SCW

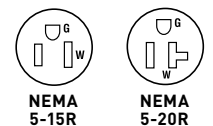

Project
Location/Type

TECHNICAL SPECIFICATIONS

Heavy-Duty Tamper-Resistant Decorator Receptacles

2 Pole, 3 Wire Grounding 15 & 20A, 125V

Typical Specifications

Manufacturer's Identification: Pass & Seymour® TR26362
 Description: PlugTail™ Straight Blade Duplex Receptacle – Heavy-Duty Tamper-Resistant Decorator
 Type: 2 Pole, 3 Wire Grounding
 Rating: 15A, 125V
 Configuration: NEMA 5-15R
 3rd Party Compliance: UL Listed, File Number E140596, Standard UL498, Federal Specification WC596, CSA Certified, File Number LR16063, Standard CSA-C22.2 No. 42. Conforms to NEMA WD-1 and WD-6.

CATALOG NUMBER	COLOR	RATING	NEMA CONFIG. NO.	CATALOG NUMBER	COLOR	RATING	NEMA CONFIG. NO.
<input type="checkbox"/> TR26262I	Ivory	15A 125V	5-15R	<input type="checkbox"/> TR26262HGI	Ivory	15A 125V	5-15R
<input type="checkbox"/> TR26262W	White	15A 125V	5-15R	<input type="checkbox"/> TR26262HGW	White	15A 125V	5-15R
<input type="checkbox"/> TR26262	Brown	15A 125V	5-15R	<input type="checkbox"/> TR26262HGGRY	Gray	15A 125V	5-15R
<input type="checkbox"/> TR26262GRY	Gray	15A 125V	5-15R	<input type="checkbox"/> TR26262HGRED	Red	15A 125V	5-15R
<input type="checkbox"/> TR26262BK	Black	15A 125V	5-15R	<input type="checkbox"/> TR26262HGLA	Lt. Almond	15A 125V	5-15R
<input type="checkbox"/> TR26262RED	Red	15A 125V	5-15R	<input type="checkbox"/> TR26362HGI	Ivory	20A 125V	5-20R
<input type="checkbox"/> TR26262LA	Lt. Almond	15A 125V	5-15R	<input type="checkbox"/> TR26362HGW	White	20A 125V	5-20R
<input type="checkbox"/> TR26362I	Ivory	20A 125V	5-20R	<input type="checkbox"/> TR26362HGGRY	Gray	20A 125V	5-20R
<input type="checkbox"/> TR26362W	White	20A 125V	5-20R	<input type="checkbox"/> TR26362HGBK	Black	20A 125V	5-20R
<input type="checkbox"/> TR26362	Brown	20A 125V	5-20R	<input type="checkbox"/> TR26362HGRED	Red	20A 125V	5-20R
<input type="checkbox"/> TR26362GRY	Gray	20A 125V	5-20R	<input type="checkbox"/> TR26362HGLA	Lt. Almond	20A 125V	5-20R
<input type="checkbox"/> TR26362BK	Black	20A 125V	5-20R				
<input type="checkbox"/> TR26362RED	Red	20A 125V	5-20R				
<input type="checkbox"/> TR26362LA	Lt. Almond	20A 125V	5-20R				

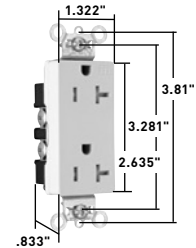

TR26362I

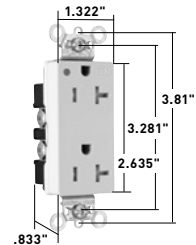

TR26362HGI

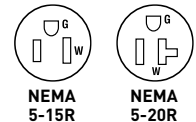

Performance

Electrical

Dielectric Voltage: Withstands 2000V minimum
 Maximum Working Voltage: 250V
 Current Interrupting: Certified for current interrupting at full-rated current
 Temperature Rise: Maximum 30°C temperature rise at full-rated current after 50 cycles of overload at 150% of rated current with direct current

Mechanical

Terminal Identification: Terminal identification in accordance with UL498 (Brass, White, Green)
 Terminal Accommodation: #14 – #10 AWG copper conductor only
 Product Identification: Ratings are a permanent part of the device

Environmental

Flammability: UL94 V2
 Operating Temperature: Maximum continuous +60°C, minimum -40°C without impact

Materials

Face:	Nylon	Tamper Shutter:	Thermoplastic
Back Body:	Nylon	Terminal Screws:	#10 Tri-Drive Brass (Neutral = Nickel-Plated Steel)
Line Contacts:	.036 688 Brass	Ground Screw:	#10 Hex Tri-Drive Brass
Mounting Strap:	Plated Steel	Auto-Ground Clip:	Steel
Ground Contacts:	Strap with Integral Ground	Mounting Screws:	Tri-Drive Steel
Pressure Plate:	.031 260 Brass		

Consult Straight Blade Section B for complete compliance listing.

Project
Location/Type

TECHNICAL SPECIFICATIONS

Commercial Specification Grade Tamper-Resistant Receptacles

Back & Side Wire 2 Pole, 3 Wire Grounding 15 & 20A, 125V

Typical Specifications

Manufacturer's Identification: Pass & Seymour® TR26242

Description: Straight Blade Duplex Receptacle – Commercial Specification Grade Tamper-Resistant

Type: 2 Pole, 3 Wire Grounding

Rating: 15A, 125V

Configuration: NEMA 5-15R

3rd Party Compliance: UL Listed, File Number E140596, Standard UL498,

CSA Certified, File Number LR16063, Standard CSA-C22.2 No. 42. Conforms to NEMA WD-1 and WD-6.

CATALOG NUMBER	COLOR	RATING	NEMA CONFIG. NO.	CATALOG NUMBER	COLOR	RATING	NEMA CONFIG. NO.
<input type="checkbox"/> TR26242I	Ivory	15A 125V	5-15R	<input type="checkbox"/> TR26252I	Ivory	15A 125V	5-15R
<input type="checkbox"/> TR26242W	White	15A 125V	5-15R	<input type="checkbox"/> TR26252W	White	15A 125V	5-15R
<input type="checkbox"/> TR26242	Brown	15A 125V	5-15R	<input type="checkbox"/> TR26252	Brown	15A 125V	5-15R
<input type="checkbox"/> TR26242GRY	Gray	15A 125V	5-15R	<input type="checkbox"/> TR26252GRY	Gray	15A 125V	5-15R
<input type="checkbox"/> TR26242BK	Black	15A 125V	5-15R	<input type="checkbox"/> TR26252BK	Black	15A 125V	5-15R
<input type="checkbox"/> TR26242LA	Lt. Almond	15A 125V	5-15R	<input type="checkbox"/> TR26252LA	Lt. Almond	15A 125V	5-15R
<input type="checkbox"/> TR26342I	Ivory	20A 125V	5-20R	<input type="checkbox"/> TR26352I	Ivory	20A 125V	5-20R
<input type="checkbox"/> TR26342W	White	20A 125V	5-20R	<input type="checkbox"/> TR26352W	White	20A 125V	5-20R
<input type="checkbox"/> TR26342	Brown	20A 125V	5-20R	<input type="checkbox"/> TR26352	Brown	20A 125V	5-20R
<input type="checkbox"/> TR26342GRY	Gray	20A 125V	5-20R	<input type="checkbox"/> TR26352GRY	Gray	20A 125V	5-20R
<input type="checkbox"/> TR26342BK	Black	20A 125V	5-20R	<input type="checkbox"/> TR26352BK	Black	20A 125V	5-20R
<input type="checkbox"/> TR26342LA	Lt. Almond	20A 125V	5-20R	<input type="checkbox"/> TR26352LA	Lt. Almond	20A 125V	5-20R

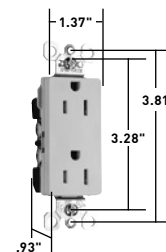

TR26242I

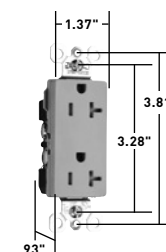

TR26352GRY

2 Pole, 3 Wire

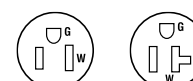

NEMA 5-15R

NEMA 5-20R

Performance

Electrical

Dielectric Voltage: Withstands 2000V minimum

Maximum Working Voltage: 250V

Current Interrupting: Certified for current interrupting at full-rated current

Temperature Rise: Maximum 30°C temperature rise at full-rated current after 50 cycles of overload at 150% of rated current with direct current

Mechanical

Terminal Identification: Terminal identification in accordance with UL498 (Brass, White, Green)

Terminal Accommodation: #14 – #10 AWG copper conductor only

Product Identification: Ratings are a permanent part of the device

Environmental

Flammability: UL94 V2

Operating Temperature: Maximum continuous +60°C, minimum -40°C without impact

Materials

Face: Nylon

Back Body: Nylon

Line Contacts: .032 260 Brass

Mounting Strap: .042 Zinc-Plated Steel

Ground Contacts: .040 260 Brass

Tamper-Resistant

Shutters Thermoplastic

Terminal Screws: #8 Tri-Drive Steel (Neutral = Nickel-Plated Steel)

Ground Screw: #8 Hex Tri-Drive Steel; Zinc Coating with Green Chromate

Auto-Ground Clip: Steel

Mounting Screws: Tri-Drive Steel

Project
Location/Type

TECHNICAL SPECIFICATIONS

Heavy-Duty Tamper-Resistant Decorator & Hospital Grade Single Receptacles

2 Pole, 3 Wire Grounding 15 & 20A, 125V

Typical Specifications

Manufacturer's Identification: Pass & Seymour® TR26261

Description: PlugTail™ Straight Blade Duplex Receptacle – Heavy-Duty Tamper-Resistant Decorator and Hospital Grade

Type: 2 Pole, 3 Wire Grounding

Rating: 15A, 125V

Configuration: NEMA 5-15R

3rd Party Compliance: UL Listed, File Number E140596, Standard UL498, Federal Specification WC596, CSA Certified, Standard CSA-C22.2 No. 42. Conforms to NEMA WD-1 and WD-6.

Heavy-Duty Tamper-Resistant Decorator Single Receptacles

CATALOG NUMBER	COLOR	RATING	NEMA CONFIG. NO.	CATALOG NUMBER	COLOR	RATING	NEMA CONFIG. NO.
☐ TR26261I	Ivory	15A 125V	5-15R	☐ TR26361I	Ivory	20A 125V	5-20R
☐ TR26261W	White	15A 125V	5-15R	☐ TR26361W	White	20A 125V	5-20R
☐ TR26261	Brown	15A 125V	5-15R	☐ TR26361	Brown	20A 125V	5-20R
☐ TR26261GRY	Gray	15A 125V	5-15R	☐ TR26361GRY	Gray	20A 125V	5-20R
☐ TR26261BK	Black	15A 125V	5-15R	☐ TR26361BK	Black	20A 125V	5-20R
☐ TR26261LA	Lt. Almond	15A 125V	5-15R	☐ TR26361LA	Lt. Almond	20A 125V	5-20R

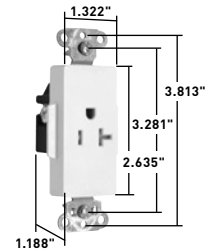

TR26361LA

Heavy-Duty Tamper-Resistant Hospital Grade Decorator Single Receptacles

CATALOG NUMBER	COLOR	RATING	NEMA CONFIG. NO.	CATALOG NUMBER	COLOR	RATING	NEMA CONFIG. NO.
☐ TR26261HGI	Ivory	15A 125V	5-15R	☐ TR26361HGI	Ivory	20A 125V	5-20R
☐ TR26261HGW	White	15A 125V	5-15R	☐ TR26361HGW	White	20A 125V	5-20R
☐ TR26261HG	Brown	15A 125V	5-15R	☐ TR26361HG	Brown	20A 125V	5-20R
☐ TR26261HGGRY	Gray	15A 125V	5-15R	☐ TR26361HGGRY	Gray	20A 125V	5-20R
☐ TR26261HGBK	Black	15A 125V	5-15R	☐ TR26361HGBK	Black	20A 125V	5-20R
☐ TR26261HGLA	Lt. Almond	15A 125V	5-15R	☐ TR26361HGLA	Lt. Almond	20A 125V	5-20R

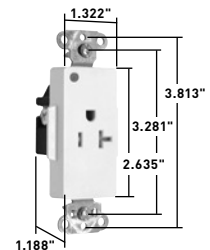

TR26361HGLA

Performance

Electrical

- Dielectric Voltage: Withstands 2000V minimum
- Maximum Working Voltage: 125V
- Current Interrupting: Certified for current interrupting at full-rated current
- Temperature Rise: Maximum 30°C temperature rise at full-rated current after 50 cycles of overload at 150% of rated current with direct current

Mechanical

- Terminal Identification: Terminal identification in accordance with UL498 (Brass, White, Green)
- Terminal Accommodation: #14 – #10 AWG copper conductor only
- Product Identification: Ratings are a permanent part of the device

Environmental

- Flammability: UL94 V2
- Operating Temperature: Maximum continuous +60°C, minimum -40°C without impact

Materials

- Face: Nylon
- Back Body: PVC
- Line Contacts: .032 (.8) Brass
- Mounting Strap: .042 Zinc-Plated Steel
- Clamping Plate: .080 Steel
- Tamper Shutter: Thermoplastic
- Terminal Screws: Tri-Drive Brass
- Hex Head: Tri-Drive Zinc-Plated
- Grounding Screw: Steel with Green Chromate
- Assembly Drive Screws: Zinc-Plated Steel
- Auto-Ground Clip: Stainless Steel
- Mounting Screws: Tri-Drive Steel

Consult Straight Blade Section B for complete compliance listing.

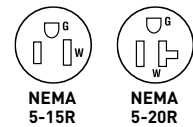

TECHNICAL SPECIFICATIONS

Project
Location/Type

TECHNICAL SPECIFICATIONS

Specification Grade Combination Receptacles 2 Pole, 3 Wire Grounding 20A, 120/125VAC

Typical Specifications

Manufacturer's Identification: Pass & Seymour® PS8HWL
 Description: Combination Straight Blade Receptacle – Specification Grade
 Type: 2 Pole, 3 Wire Grounding
 Rating: 20A, 120/125V
 Configuration: NEMA 5-15R
 3rd Party Compliance: cULus Listed, File Number E140596, Standard UL498. Conforms to NEMA WD-1 and WD-6.

CATALOG NUMBER	COLOR	RATING	NEMA CONFIG. NO.
☐ PS8HWLW	White	20A 120/125V	5-20R
☐ PS8HWLLA	Lt. Almond	20A 120/125V	5-20R

Light output in 1' FCD = 0.2561. FCD = Foot Candle Distance. 1 Lumen = 1 FCD.
 See Page U-68 for more information.

Performance

Electrical

Dielectric Voltage: Withstands 1500V minimum
 Maximum Working Voltage: 125V
 Maximum Continuous Current: 20A
 Temperature Rise: Maximum 30°C after 50 cycles at 150% of rated current

Mechanical

Terminal Accommodation: #14 AWG – #10 AWG
 Product Identification: Amperage, Voltage, 3rd Party Compliance

Environmental

Flammability: UL94 V2
 Operating Temperature: Maximum continuous +50°C, minimum -40°C (without impact)

Materials

Face:	Polycarbonate	Terminal Screws:	#8 Tri-Drive Brass
Back Body:	Polycarbonate	Ground Screw:	#8 Hex Tri-Drive Brass
Line Contacts:	.031 688 Brass	Mounting Screws:	Tri-Drive Steel
Mounting Strap:	.047 Steel	Lens:	Polycarbonate
Ground Contacts:	.040 260 Brass	Illuminating Lamp:	2 LED
Pressure Plate:	.031 260 Brass		

Consult Straight Blade Section B for complete compliance listing.

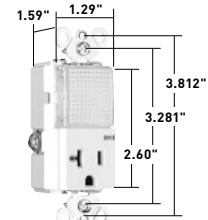

PS8HWLLA



Project
Location/Type

TECHNICAL SPECIFICATIONS

Hallway Lights – Light Output Measurements

Standard 4 Watt Incandescent Nightlight

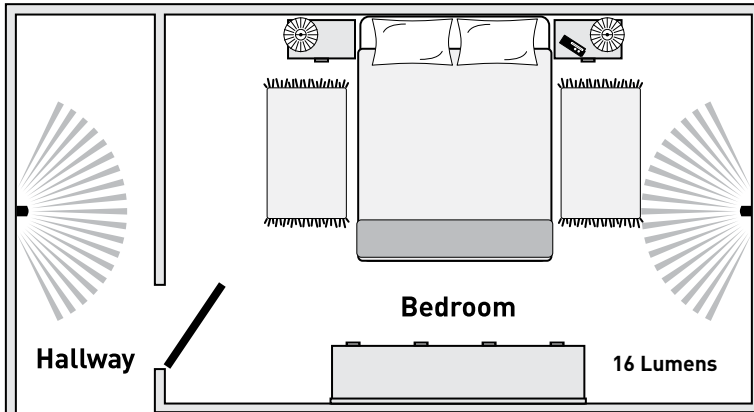

- Light output is adjustable
- Optionals louvers (NTL885TR, NTLFULL)
- Light temperature 6000°K

CATALOG NUMBER	DESCRIPTION	LIGHT OUTPUT IN 1' FCD*
P&S ENHANCED LED NIGHTLIGHTS		
NTL885TR	Adjustable LED Nightlight with Two 15A Tamper-Resistant Outlets and Optional Louver	.09
NTLFULL	Adjustable LED Nightlight and Optional Louver	2.8
NTL873	Adjustable LED Nightlight with Single Pole/3-Way Switch	1.5
PS8HWL	Specification Grade Enhanced Decorator Hallway Light & Single Receptacle	0.2561
1597NTLRCC4	Combination Enhanced Nightlight/ GFCI (15 Amp)	0.180
2097NTLTR	Combination Enhanced Nightlight/ GFCI (20 Amp)	0.180
P&S LED NIGHTLIGHTS		
TMHWLCC	Decorator Full Hallway Light with Light Sensor	0.1328
TM8HWLCC	Decorator Hallway Light and Single Receptacle	0.1442

*FCD = Foot Candle Distance. 1 Lumen = 1 FCD.

NIGHTLIGHT SETTING	LIGHT OUTPUT	WITH LOUVER
High	30 lumens	10 lumens
Medium	15 lumens	5 lumens
Low	7 lumens	2.5 lumens
Ultra Low	2 lumens	1 lumens
Standard 4 Watt Incandescent Nightlight	16 lumens	—

TECHNICAL SPECIFICATIONS

Project
Location/Type

TECHNICAL SPECIFICATIONS

radiant® Tamper-Resistant Self-Test GFCI Receptacles 2 Pole, 3 Wire Grounding 15 & 20A, 125VAC

Typical Specifications

Manufacturer's Identification: Pass & Seymour® 1597TR

Description: Straight Blade Duplex Tamper-Resistant Self-Test GFCI Receptacle

Type: 2 Pole, 3 Wire Grounding

Rating: 20A, 125VAC Feed Thru; 15 or 20A, 125VAC Face

3rd Party Compliance: cULus Listed, File Number E42190; Standard UL498 Tamper-Resistant, Attachment

Plugs and Receptacles UL943 GFCIs. Federal Specification WC596. Standard CSA-C22.2 No. 42, General

Use Receptacles, CSA-C22.2 No. 144 GFCIs. Conforms to NEMA WD-1 and WD-6.

CATALOG NUMBER	COLOR	RATING	NEMA CONFIG. NO.
<input type="checkbox"/> 1597TRI	Ivory	15A 125VAC	5-15R
<input type="checkbox"/> 1597TRW	White	15A 125VAC	5-15R
<input type="checkbox"/> 1597TR	Brown	15A 125VAC	5-15R
<input type="checkbox"/> 1597TRBK	Black	15A 125VAC	5-15R
<input type="checkbox"/> 1597TRLA	Light Almond	15A 125VAC	5-15R
<input type="checkbox"/> 1597TRNICC4	Nickel	15A 125VAC	5-15R
<input type="checkbox"/> 1597TRDBCC4	Dark Bronze	15A 125VAC	5-15R
<input type="checkbox"/> 2097TRI	Ivory	20A 125VAC	5-20R
<input type="checkbox"/> 2097TRW	White	20A 125VAC	5-20R
<input type="checkbox"/> 2097TR	Brown	20A 125VAC	5-20R
<input type="checkbox"/> 2097TRGRY	Gray	20A 125VAC	5-20R
<input type="checkbox"/> 2097TRBK	Black	20A 125VAC	5-20R
<input type="checkbox"/> 2097TRRED	Red	20A 125VAC	5-20R
<input type="checkbox"/> 2097TRLA	Light Almond	20A 125VAC	5-20R

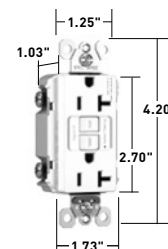

Dimensions for
15 & 20 Amp

Performance

Electrical

Dielectric: Withstands 1500V minimum

Trip Level: 4 to 6 mA

Trip Time: .025 Second Nominal

Frequency: 60 Hz

Voltage: 125VAC

Voltage Range: 102-132VAC

Mechanical

Indicator Light (LED): Red, ON when GFCI is tripped

Terminal Identification: Terminals identified in accordance with UL498 (Hot, White, Green)

Terminal Accommodation: #14 - #10 AWG solid or stranded copper conductor only

Product Identification: Ratings are a permanent part of device

Environmental

Operating Temperature: -35°C to +66°C

Maximum Humidity: 95%

Flammability: UL94 V2

Materials

Face: Nylon

Body: Nylon

Contacts: .03" Brass (.8)

Mounting Straps: .05" Zinc-Plated Steel (1.3)

Terminal Screws: Steel #8 - 32

Hex Head Grounding Screw: Steel (Green)

Flat Head Mounting Screws: Zinc-Plated Steel

Test/Reset Buttons: Nylon

Tamper-Resistant Shutter: Thermoplastic

Auto-Ground Clip: Brass Alloy C260

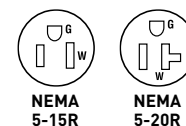

NEMA
5-15R

NEMA
5-20R

Project

Location/Type

TECHNICAL SPECIFICATIONS

Hospital Grade Tamper-Resistant Self-Test GFCI Receptacles 2 Pole, 3 Wire Grounding 15 & 20A, 125VAC

Typical Specifications

Manufacturer's Identification: Pass & Seymour® 1597HGTR
 Description: Straight Blade Duplex Hospital Grade Tamper-Resistant Self-Test GFCI Receptacle
 Type: 2 Pole, 3 Wire Grounding
 Rating: 20A, 125VAC Feed Thru; 15 or 20A, 125VAC Face
 3rd Party Compliance: cULus Listed, File Number E42190, Standard UL498 Tamper-Resistant, Attachment Plugs and Receptacles UL943 GFCIs. Federal Specification WC596 Hospital Grade. Standard CSA-C22.2 No. 42, General Use Receptacles, CSA-C22.2 No. 144 GFCIs. Conforms to NEMA WD-1 and WD-6.

CATALOG NUMBER	COLOR	RATING	NEMA CONFIG. NO.
<input type="checkbox"/> 1597HGTRI	Ivory	15A 125VAC	5-15R
<input type="checkbox"/> 1597HGTRW	White	15A 125VAC	5-15R
<input type="checkbox"/> 1597HGTR	Brown	15A 125VAC	5-15R
<input type="checkbox"/> 1597HGTRBK	Black	15A 125VAC	5-15R
<input type="checkbox"/> 1597HGTRGRY	Gray	15A 125VAC	5-15R
<input type="checkbox"/> 1597HGTRRED	Red	15A 125VAC	5-15R
<input type="checkbox"/> 1597HGTRLA	Light Almond	15A 125VAC	5-15R
<input type="checkbox"/> 2097HGTRI	Ivory	20A 125VAC	5-20R
<input type="checkbox"/> 2097HGTRW	White	20A 125VAC	5-20R
<input type="checkbox"/> 2097HGTR	Brown	20A 125VAC	5-20R
<input type="checkbox"/> 2097HGTRBK	Black	20A 125VAC	5-20R
<input type="checkbox"/> 2097HGTRGRY	Gray	20A 125VAC	5-20R
<input type="checkbox"/> 2097HGTRRED	Red	20A 125VAC	5-20R
<input type="checkbox"/> 2097HGTRLA	Light Almond	20A 125VAC	5-20R

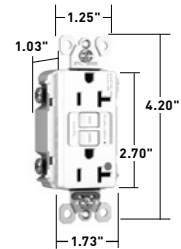

**Dimensions for
15 & 20 Amp**

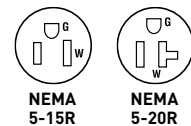

Performance

Electrical

Dielectric: Withstands 1500V minimum
 Trip Level: 4 to 6 mA
 Trip Time: .025 Second Nominal
 Frequency: 60 Hz
 Voltage: 125VAC
 Voltage Range: 102-132VAC

Mechanical

Indicator Light (LED): Red, ON when GFCI is tripped
 Terminal Identification: Terminals identified in accordance with UL498 (Hot, White, Green)
 Terminal Accommodation: #14 – #10 AWG solid or stranded copper conductor only
 Product Identification: Ratings are a permanent part of the device

Environmental

Operating Temperature: -35°C to +66°C
 Maximum Humidity: 95%
 Flammability: UL94 V2

Materials

Face:	Nylon	Hex Head Grounding Screw:	Steel (Green)
Body:	Nylon	Flat Head Mounting Screw:	Zinc-Plated Steel
Contacts:	.03" Brass (.8)	Test/Reset Buttons:	Nylon
Mounting Strap:	.05" Zinc-Plated Steel (1.3)	Tamper-Resistant Shutter:	Thermoplastic
Terminal Screws:	Steel #8 - 32		

TECHNICAL SPECIFICATIONS

Project
Location/Type

TECHNICAL SPECIFICATIONS

radiant® & Specification Grade Self-Test GFCI Receptacles 2 Pole, 3 Wire Grounding 15 & 20A, 125VAC

Typical Specifications

Manufacturer's Identification: Pass & Seymour® 1597

Description: Straight Blade Duplex Self-Test GFCI Receptacle

Type: 2 Pole, 3 Wire Grounding

Rating: 20A, 125VAC Feed Thru; 15 or 20A, 125VAC Face

3rd Party Compliance: cULus Listed, File Number E42190; Standard UL498, Attachment Plugs

and Receptacles UL943 GFCIs. Federal Specification WC596. Standard CSA-C22.2 No. 42,

General Use Receptacles, CSA-C22.2 No. 144 GFCIs. Conforms to NEMA WD-1 and WD-6.

CATALOG NUMBER	COLOR	RATING	NEMA CONFIG. NO.	CATALOG NUMBER	COLOR	RATING	NEMA CONFIG. NO.
<input type="checkbox"/> 1597I	Ivory	15A 125VAC	5-15R	<input type="checkbox"/> 2097I	Ivory	20A 125VAC	5-20R
<input type="checkbox"/> 1597W	White	15A 125VAC	5-15R	<input type="checkbox"/> 2097W	White	20A 125VAC	5-20R
<input type="checkbox"/> 1597	Brown	15A 125VAC	5-15R	<input type="checkbox"/> 2097	Brown	20A 125VAC	5-20R
<input type="checkbox"/> 1597GRY	Gray	15A 125VAC	5-15R	<input type="checkbox"/> 2097GRY	Gray	20A 125VAC	5-20R
<input type="checkbox"/> 1597BK	Black	15A 125VAC	5-15R	<input type="checkbox"/> 2097BK	Black	20A 125VAC	5-20R
<input type="checkbox"/> 1597RED	Red	15A 125VAC	5-15R	<input type="checkbox"/> 2097RED	Red	20A 125VAC	5-20R
<input type="checkbox"/> 1597LA	Light Almond	15A 125VAC	5-15R	<input type="checkbox"/> 2097LA	Light Almond	20A 125VAC	5-20R

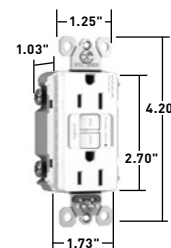

Dimensions for
15 & 20 Amp

Performance

Electrical

Dielectric: Withstands 1500V minimum

Trip Level: 4 to 6 mA

Trip Time: .025 Second Nominal

Frequency: 60 Hz

Voltage: 125VAC

Voltage Range: 102-132VAC

Mechanical

Indicator Light (LED): Red, ON when GFCI is tripped

Terminal Identification: Terminals identified in accordance with UL498 (Hot, White, Green)

Terminal Accommodation: #14 - #10 AWG solid or stranded copper conductor only

Product Identification: Ratings are a permanent part of device

Environmental

Operating Temperature: -35°C to +66°C

Maximum Humidity: 95%

Flammability: UL94 V2

Materials

Face: Nylon

Body: Nylon

Contacts: .03" Brass (.8)

Mounting Strap: .05" Zinc-Plated Steel (1.3)

Terminal Screws: Steel #8 - 32

Hex Head Grounding Screw: Steel (Green)

Flat Head Mounting Screws: Zinc-Plated Steel

Test/Reset Buttons: Nylon

Auto-Ground Clip: Brass Alloy C260



NEMA
5-15R



NEMA
5-20R

Project
Location/Type

TECHNICAL SPECIFICATIONS

Hospital Grade Self-Test GFCI Receptacles 2 Pole, 3 Wire Grounding 20A, 125VAC

Typical Specifications

Manufacturer's Identification: Pass & Seymour® 1597HG
 Description: Straight Blade Duplex Hospital Grade Self-Test GFCI Receptacle
 Type: 2 Pole, 3 Wire Grounding
 Rating: 20A, 125VAC Feed Thru; 15 or 20A, 125VAC Face
 3rd Party Compliance: cULus Listed, File Number E42190, Standard UL498, Attachment Plugs and Receptacles UL943 GFCIs. Federal Specification WC596 Hospital Grade. Standard CSA-C22.2 No. 42, General Use Receptacles, CSA-C22.2 No. 144 GFCIs. Conforms to NEMA WD-1 and WD-6.

CATALOG NUMBER	COLOR	RATING	NEMA CONFIG. NO.
<input type="checkbox"/> 1597HGI	Ivory	15A 125VAC	5-15R
<input type="checkbox"/> 1597HGW	White	15A 125VAC	5-15R
<input type="checkbox"/> 1597HGBK	Black	15A 125VAC	5-15R
<input type="checkbox"/> 1597HGGRY	Gray	15A 125VAC	5-15R
<input type="checkbox"/> 1597HGRED	Red	15A 125VAC	5-15R
<input type="checkbox"/> 1597HGLA	Light Almond	15A 125VAC	5-15R
<input type="checkbox"/> 2097HGI	Ivory	20A 125VAC	5-20R
<input type="checkbox"/> 2097HGW	White	20A 125VAC	5-20R
<input type="checkbox"/> 2097HG	Brown	20A 125VAC	5-20R
<input type="checkbox"/> 2097HGBK	Black	20A 125VAC	5-20R
<input type="checkbox"/> 2097HGGRY	Gray	20A 125VAC	5-20R
<input type="checkbox"/> 2097HGRED	Red	20A 125VAC	5-20R
<input type="checkbox"/> 2097HGLA	Light Almond	20A 125VAC	5-20R

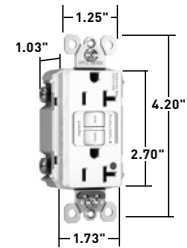

Dimensions for 15 & 20 Amp

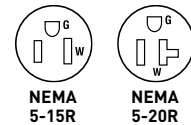

Performance

Electrical

Dielectric: Withstands 1500V minimum
 Trip Level: 4 to 6 mA
 Trip Time: .025 Second Nominal
 Frequency: 60 Hz
 Voltage: 125VAC
 Voltage Range: 102-132VAC

Mechanical

Indicator Light (LED): Red, ON when GFCI is tripped
 Terminal Identification: Terminals identified in accordance with UL498 (Hot, White, Green)
 Terminal Accommodation: #14 - #10 AWG solid or stranded copper conductor only
 Product Identification: Ratings are a permanent part of the device

Environmental

Operating Temperature: -35°C to +66°C
 Maximum Humidity: 95%
 Flammability: UL94 V2

Materials

Face:	Nylon	Terminal Screws:	Steel #8 - 32
Body:	Nylon	Hex Head Grounding Screw:	Steel (Green)
Contacts:	.03" Brass (.8)	Flat Head Mounting Screw:	Zinc-Plated Steel
Mounting Strap:	.05" Zinc-Plated Steel (1.3)	Test/Reset Buttons:	Nylon

Project
Location/Type

TECHNICAL SPECIFICATIONS

radiant® Tamper-Resistant Nightlight/Self-Test GFCI Receptacles

2 Pole, 3 Wire Grounding 15 & 20A, 125VAC

Typical Specifications

Manufacturer's Identification: Pass & Seymour® 1597NTLTRCC4

Description: Straight Blade Duplex Tamper-Resistant Nightlight/Self-Test GFCI Receptacle

Type: 2 Pole, 3 Wire Grounding

Rating: 20A, 125VAC Feed Thru; 15 or 20A, 125VAC Face

3rd Party Compliance: cULus Listed, File Number E42190; Standard UL498 Tamper-Resistant, Attachment Plugs and Receptacles UL943 GFCIs. Federal Specification WC596. Standard CSA-C22.2 No. 42, General Use Receptacles, CSA-C22.2 No. 144 GFCIs. Conforms to NEMA WD-1 and WD-6.

CATALOG NUMBER	COLOR	RATING	NEMA CONFIG. NO.
<input type="checkbox"/> 1597NTLTRICC4	Ivory	15A 125VAC	5-15R
<input type="checkbox"/> 1597NTLTRWCC4	White	15A 125VAC	5-15R
<input type="checkbox"/> 1597NTLTRBKCC4	Black	15A 125VAC	5-15R
<input type="checkbox"/> 1597NTLTRLACC4	Light Almond	15A 125VAC	5-15R
<input type="checkbox"/> 1597NTLTRNICC4	Nickel	15A 125VAC	5-15R
<input type="checkbox"/> 1597NTLTRDBCC4	Dark Bronze	15A 125VAC	5-15R
<input type="checkbox"/> 2097NTLTRI	Ivory	20A 125VAC	5-20R
<input type="checkbox"/> 2097NTLTRW	White	20A 125VAC	5-20R
<input type="checkbox"/> 2097NTLTRGRY	Gray	20A 125VAC	5-20R
<input type="checkbox"/> 2097NTLTRLA	Light Almond	20A 125VAC	5-20R

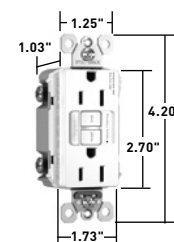

Dimensions for
15 & 20 Amp

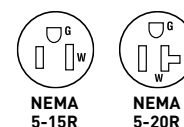

Performance

Electrical

Dielectric: Withstands 1500V minimum

Trip Level: 4 to 6 mA

Trip Time: .025 Second Nominal

Frequency: 60 Hz

Voltage: 125VAC

Voltage Range: 102-132VAC

Mechanical

Indicator Light (LED): Red, ON when GFCI is tripped

Terminal Identification: Terminals identified in accordance with UL498 (Hot, White, Green)

Terminal Accommodation: #14 - #10 AWG solid or stranded copper conductor only

Product Identification: Ratings are a permanent part of device

Environmental

Operating Temperature: -35°C to +66°C

Maximum Humidity: 95%

Flammability: UL94 V2

Materials

Face: Nylon

Body: Nylon

Contacts: .03" Brass (.8)

Mounting Strap: .05" Zinc-Plated Steel (1.3)

Terminal Screws: Steel #8 - 32

Hex Head Grounding Screw: Steel (Green)

Flat Head Mounting Screw: Zinc-Plated Steel

Test/Reset Buttons: Nylon

Nightlight Lens: Lexan®

Tamper-Resistant Shutter: Thermoplastic

Project

Location/Type



TECHNICAL SPECIFICATIONS

Hospital Grade Tamper-Resistant Nightlight/Self-Test GFCI Receptacles

2 Pole, 3 Wire Grounding 15 & 20A, 125VAC

Typical Specifications

Manufacturer's Identification: Pass & Seymour® 2097HGNTLTR

Description: Straight Blade Duplex Hospital Grade Tamper-Resistant Nightlight/Self-Test GFCI Receptacle

Type: 2 Pole, 3 Wire Grounding

Rating: 20A, 125VAC Feed Thru; 15 or 20A, 125VAC Face

3rd Party Compliance: cULus Listed, File Number E42190, Standard UL498 Tamper-Resistant, Attachment Plugs and Receptacles UL943 GFCIs, Federal Specification WC596 Hospital Grade, Standard CSA-C22.2 No. 42, General Use Receptacles, CSA-C22.2 No. 144 GFCIs. Conforms to NEMA WD-1 and WD-6.

CATALOG NUMBER	COLOR	RATING	NEMA CONFIG. NO.
<input type="checkbox"/> 2097HGNTLTRI	Ivory	20A 125VAC	5-20R
<input type="checkbox"/> 2097HGNTLTRW	White	20A 125VAC	5-20R
<input type="checkbox"/> 2097HGNTLTRGRY	Gray	20A 125VAC	5-20R
<input type="checkbox"/> 2097HGNTLTRRED	Red	20A 125VAC	5-20R
<input type="checkbox"/> 2097HGNTLTRLA	Light Almond	20A 125VAC	5-20R

Performance

Electrical

Dielectric:	Withstands 1500V minimum
Trip Level:	4 to 6 mA
Trip Time:	.025 Second Nominal
Frequency:	60 Hz
Voltage:	125VAC
Voltage Range:	102-132VAC

Mechanical

Indicator Light (LED)	Red, ON when GFCI is tripped
Terminal Identification:	Terminals identified in accordance with UL498 (Hot, White, Green)
Terminal Accommodation:	#14 - #10 AWG solid or stranded copper conductor only
Product Identification:	Ratings are a permanent part of the device

Environmental

Operating Temperature:	-35°C to +66°C
Maximum Humidity:	95%
Flammability:	UL94 V2

Materials

Face:	Nylon	Hex Head Grounding Screw:	Steel (Green)
Body:	Nylon	Flat Head Mounting Screw:	Zinc-Plated Steel
Contacts:	.03" Brass (.8)	Test/Reset Buttons:	Nylon
Mounting Strap:	.05" Zinc-Plated Steel (1.3)	Nightlight Lens:	Lexan®
Terminal Screws:	Steel #8 - 32	Tamper-Resistant Shutter:	Thermoplastic

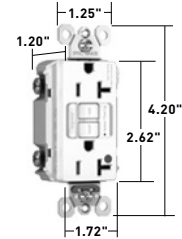

Dimensions for
20 Amp

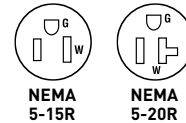

Project
Location/Type

TECHNICAL SPECIFICATIONS

radiant® Weather-Resistant Self-Test GFCI Receptacles 2 Pole, 3 Wire Grounding 15 & 20A, 125VAC

Typical Specifications

Manufacturer's Identification: Pass & Seymour® 1597TRWR

Description: Straight Blade Duplex Weather-Resistant Self-Test GFCI Receptacle

Type: 2 Pole, 3 Wire Grounding

Rating: 20A, 125VAC Feed Thru; 15 or 20A, 125VAC Face

3rd Party Compliance: cULus Listed, File Number E42190; Standard UL498 Weather-Resistant, Tamper-Resistant, Attachment Plugs and Receptacles; UL943 GFCIs. Federal Specification WC596. Standard CSA-C22.2 No. 42, General Use Receptacles, CSA-C22.2 No. 144 GFCIs. Conforms to NEMA WD-1 and WD-6.

CATALOG NUMBER	COLOR	RATING	NEMA CONFIG. NO.
<input type="checkbox"/> 1597TRWRI	Ivory	15A 125VAC	5-15R
<input type="checkbox"/> 1597TRWRW	White	15A 125VAC	5-15R
<input type="checkbox"/> 1597TRWR	Brown	15A 125VAC	5-15R
<input type="checkbox"/> 1597TRWRGRY	Gray	15A 125VAC	5-15R
<input type="checkbox"/> 1597TRWRBK	Black	15A 125VAC	5-15R
<input type="checkbox"/> 1597TRWRLA	Light Almond	15A 125VAC	5-15R
<input type="checkbox"/> 2097TRWRI	Ivory	20A 125VAC	5-20R
<input type="checkbox"/> 2097TRWRW	White	20A 125VAC	5-20R
<input type="checkbox"/> 2097TRWR	Brown	20A 125VAC	5-20R
<input type="checkbox"/> 2097TRWRGRY	Gray	20A 125VAC	5-20R
<input type="checkbox"/> 2097TRWRBK	Black	20A 125VAC	5-20R
<input type="checkbox"/> 2097TRWRLA	Light Almond	20A 125VAC	5-20R

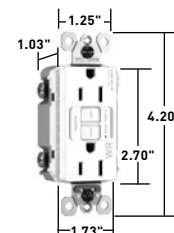

Dimensions for
15 & 20 Amp

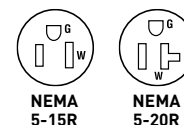

Performance

Electrical

Dielectric:	Withstands 1500V minimum
Trip Level:	4 to 6 mA
Trip Time:	.025 Second Nominal
Frequency:	60 Hz
Voltage:	125VAC
Voltage Range:	102-132VAC

Mechanical

Indicator Light (LED):	Red, ON when GFCI is tripped
Terminal Identification:	Terminals identified in accordance with UL498 (Hot, White, Green)
Terminal Accommodation:	#14 - #10 AWG solid or stranded copper conductor only
Product Identification:	Ratings are a permanent part of the device

Environmental

Operating Temperature:	-35°C to +66°C
Maximum Humidity:	95%
Flammability:	UL94 V2

Materials

Face:	Nylon 66	Terminal Screws:	Brass #8 - 32
Body:	Nylon	Hex Head Grounding Screw:	Steel (Green)
Contacts:	.03" Brass (.8)	Flat Head Mounting Screws:	Zinc-Plated Steel
Mounting Strap:	.05" Nickel Post-Plated Steel (1.3)	Test/Reset Buttons:	Nylon 66
		Tamper-Resistant Shutter:	Thermoplastic

Project
Location/Type

TECHNICAL SPECIFICATIONS

radiant® Audible Alarm Tamper-Resistant Self-Test GFCI Receptacles 2 Pole, 3 Wire Grounding 15 & 20A, 125VAC

Typical Specifications

Manufacturer's Identification: Pass & Seymour® 1597TRA
 Description: Straight Blade Duplex Audible Alarm Tamper-Resistant Self-Test GFCI Receptacle
 Type: 2 Pole, 3 Wire Grounding
 Rating: 20A, 125VAC Feed Thru, 15A & 20A, 125VAC FACE
 3rd Party Compliance: cULus Listed, Standard UL498 Tamper-Resistant, Attachment Plugs and Receptacles UL943 GFCIs. Federal Specification WC596. Standard CSA-C22.2 No. 42, General Use Receptacles, CSA-C22.2 No. 144 GFCIs.

CATALOG NUMBER	COLOR	RATING	NEMA CONFIG. NO.	CATALOG NUMBER	COLOR	RATING	NEMA CONFIG. NO.
<input type="checkbox"/> 1597TRAI	Ivory	15A 125VAC	5-15R	<input type="checkbox"/> 2097TRAI	Ivory	20A 125VAC	5-20R
<input type="checkbox"/> 1597TRAW	White	15A 125VAC	5-15R	<input type="checkbox"/> 2097TRAW	White	20A 125VAC	5-20R
<input type="checkbox"/> 1597TRA	Brown	15A 125VAC	5-15R	<input type="checkbox"/> 2097TRA	Brown	20A 125VAC	5-20R
<input type="checkbox"/> 1597TRALA	Lt. Almond	15A 125VAC	5-15R	<input type="checkbox"/> 2097TRALA	Lt. Almond	20A 125VAC	5-20R

Performance

Electrical

Dielectric: Withstands 1500V minimum
 Trip Level: 4 to 6 mA
 Trip Time: .025 Second Nominal
 Frequency: 60 Hz
 Voltage: 125VAC
 Voltage Range: 102-132VAC
 Short Circuit Rating: 10kA

Mechanical

Indicator Light (LED): Red, ON when GFCI is tripped
 Audible Alarm: 60 dB at 10 feet
 Terminal Identification: Terminals identified in accordance with UL498 (Hot, White, Green)
 Terminal Accommodation: #14 – #10 AWG solid or stranded copper conductor only
 Motor Control: Rated as a 1.5 HP motor control switch
 Product Identification: Ratings are a permanent part of the device

Environmental

Operating Temperature: -35°C to +66°C
 Maximum Humidity: 95%
 Flammability: UL94 V2

Materials

Face: Nylon
 Body: Nylon
 Contacts: .03" Brass (.8)
 Mounting Strap: .05" Zinc-Plated Steel (1.3)
 Terminal Screws: Steel #8 - 32
 Flat Head Mounting Screws: Zinc-Plated Steel
 Test/Reset Buttons: Nylon

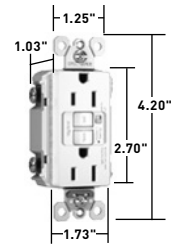
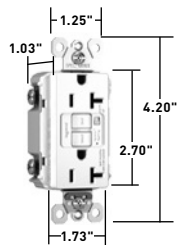
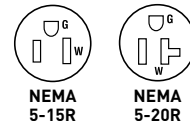
1597TRAW

2097TRAW

NEMA 5-15R
NEMA 5-20R

Project
Location/Type

TECHNICAL SPECIFICATIONS

Audible Alarm Hospital Grade Tamper-Resistant Self-Test GFCI

2 Pole, 3 Wire Grounding 15 & 20A, 125VAC

Typical Specifications

Manufacturer's Identification: Pass & Seymour® 1597HGTRA

Description: Straight Blade Duplex Audible Alarm Hospital Grade Tamper-Resistant Self-Test GFCI Receptacle

Type: 2 Pole, 3 Wire Grounding

Rating: 20A, 125VAC Feed Thru, 15A & 20A, 125VAC FACE

3rd Party Compliance: cULus Listed, Standard UL498 Tamper-Resistant, Attachment Plugs and Receptacles

UL943 GFCIs. Federal Specification WC596 Hospital Grade. Standard CSA-C22.2 No. 42, General Use Receptacles, CSA-C22.2 No. 144 GFCIs.

CATALOG NUMBER	COLOR	RATING	NEMA CONFIG. NO.	CATALOG NUMBER	COLOR	RATING	NEMA CONFIG. NO.
<input type="checkbox"/> 1597HGTRA	Brown	15A 125VAC	5-15R	<input type="checkbox"/> 2097HGTRAI	Ivory	20A 125VAC	5-20R
<input type="checkbox"/> 1597HGTRALA	Lt. Almond	15A 125VAC	5-15R	<input type="checkbox"/> 2097HGTRAW	White	20A 125VAC	5-20R
				<input type="checkbox"/> 2097HGTRARED	Red	20A 125VAC	5-20R
				<input type="checkbox"/> 2097HGTRALA	Lt. Almond	20A 125VAC	5-20R

Performance

Electrical

Dielectric: Withstands 1500V minimum

Trip Level: 4 to 6 mA

Trip Time: .025 Second Nominal

Frequency: 60 Hz

Voltage: 125VAC

Voltage Range: 102-132VAC

Short Circuit Rating: 10kA

Mechanical

Indicator Light (LED): Red, ON when GFCI is tripped

Audible Alarm: 60 dB at 10 feet

Terminal Identification: Terminals identified in accordance with UL498 (Hot, White, Green)

Terminal Accommodation: #14 – #10 AWG solid or stranded copper conductor only

Motor Control: Rated as a 1.5 HP motor control switch

Environmental

Operating Temperature: -35°C to +66°C

Maximum Humidity: 95%

Flammability: UL94 V2

Materials

Face: Nylon

Body: Nylon

Contacts: .03" Brass (.8)

Mounting Strap: .05" Zinc-Plated Steel (1.3)

Terminal Screws: Steel #8 - 32

Flat Head Mounting Screws: Zinc-Plated Steel

Test/Reset Buttons: Nylon

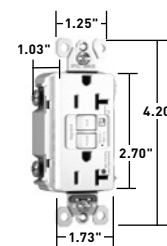

2097HGTRAW

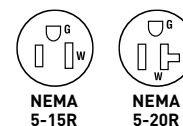

Project
Location/Type

TECHNICAL SPECIFICATIONS

radiant® Isolated-Ground Tamper-Resistant Self-Test GFCI Receptacles

2 Pole, 3 Wire Grounding 15 & 20A, 125VAC

Typical Specifications

Manufacturer's Identification: Pass & Seymour® 15971GTR
 Description: Straight Blade Duplex Isolated Ground Tamper-Resistant Self-Test GFCI Receptacle
 Type: 2 Pole, 3 Wire Grounding
 Rating: 20A, 125VAC Feed Thru, 15A & 20A, 125VAC FACE
 3rd Party Compliance: cULus Listed, Standard UL498 Tamper-Resistant, Attachment Plugs and Receptacles UL943 GFCIs. Federal Specification WC596. Standard CSA-C22.2 No. 42, General Use Receptacles, CSA-C22.2 No. 144 GFCIs.

CATALOG NUMBER	COLOR	RATING	NEMA CONFIG. NO.	CATALOG NUMBER	COLOR	RATING	NEMA CONFIG. NO.
<input type="checkbox"/> 15971GTRI	Ivory	15A 125VAC	5-15R	<input type="checkbox"/> 20971GTRI	Ivory	20A 125VAC	5-20R
<input type="checkbox"/> 15971GTRW	White	15A 125VAC	5-15R	<input type="checkbox"/> 20971GTRW	White	20A 125VAC	5-20R
<input type="checkbox"/> 15971GTRLA	Lt. Almond	15A 125VAC	5-15R	<input type="checkbox"/> 20971GTRGRY	Gray	20A 125VAC	5-20R
<input type="checkbox"/> 15971GTROCC4	Orange	15A 125VAC	5-15R	<input type="checkbox"/> 20971GTRO	Orange	20A 125VAC	5-20R
				<input type="checkbox"/> 20971GTRLA	Lt. Almond	20A 125VAC	5-20R

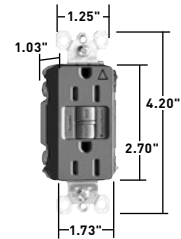

15971GTR0

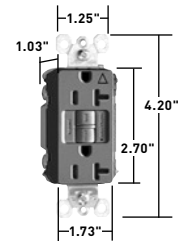

20971GTR0

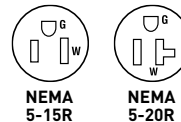

Performance

Electrical

Dielectric: Withstands 1500V minimum
 Trip Level: 4 to 6 mA
 Trip Time: .025 Second Nominal
 Frequency: 60 Hz
 Voltage: 125VAC
 Voltage Range: 102-132VAC

Mechanical

Indicator Light (LED): Red, ON when GFCI is tripped
 Terminal Identification: Terminals identified in accordance with UL498 (Hot, White)
 Terminal Accommodation: #14 – #10 AWG solid or stranded copper conductor only
 Product Identification: Ratings are a permanent part of the device

Environmental

Operating Temperature: -35°C to +66°C
 Maximum Humidity: 95%
 Flammability: UL94 V2

Materials

Face: Nylon
 Body: Nylon
 Contacts: .03" Brass (.8)
 Mounting Strap: .05" Zinc-Plated Steel (1.3)
 Terminal Screws: Steel #8 - 32
 Flat Head Mounting Screws: Zinc-Plated Steel
 Test/Reset Buttons: Nylon

TECHNICAL SPECIFICATIONS

Project
Location/Type

TECHNICAL SPECIFICATIONS

Hospital Grade Isolated-Ground Tamper-Resistant Self-Test GFCI Receptacles

2 Pole, 3 Wire Grounding 15 & 20A, 125VAC

Typical Specifications

Manufacturer's Identification: Pass & Seymour® 15971GHGTR

Description: Straight Blade Duplex Isolated Ground Tamper-Resistant Self-Test GFCI Receptacle

Type: 2 Pole, 3 Wire Grounding

Rating: 20A, 125VAC Feed Thru, 15A & 20A, 125VAC FACE

3rd Party Compliance: cULus Listed, Standard UL498 Tamper-Resistant, Attachment Plugs and Receptacles UL943 GFCIs. Federal Specification WC596 Hospital Grade. Standard CSA-C22.2 No. 42, General Use Receptacles, CSA-C22.2 No. 144 GFCIs.

CATALOG NUMBER	COLOR	RATING	NEMA CONFIG. NO.	CATALOG NUMBER	COLOR	RATING	NEMA CONFIG. NO.
<input type="checkbox"/> 15971GHGTRO	Orange	15A 125VAC	5-15R	<input type="checkbox"/> 20971GHGTRI	Ivory	20A 125VAC	5-20R
				<input type="checkbox"/> 20971GHGTRW	White	20A 125VAC	5-20R
				<input type="checkbox"/> 20971GHGTRRED	Red	20A 125VAC	5-20R
				<input type="checkbox"/> 20971GHGTR	Orange	20A 125VAC	5-20R
				<input type="checkbox"/> 20971GHGTRLA	Lt. Almond	20A 125VAC	5-20R

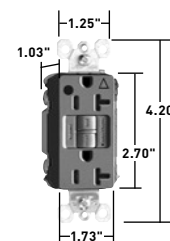

20971GHGTRO

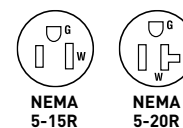

Performance

Electrical

Dielectric: Withstands 1500V minimum

Trip Level: 4 to 6 mA

Trip Time: .025 Second Nominal

Frequency: 60 Hz

Voltage: 125VAC

Voltage Range: 102-132VAC

Short Circuit Rating: 10kA

Mechanical

Indicator Light (LED): Red, ON when GFCI is tripped

Terminal Identification: Terminals identified in accordance with UL498 (Hot, White)

Terminal Accommodation: #14 - #10 AWG solid or stranded copper conductor only

Product Identification: Ratings are a permanent part of the device

Environmental

Operating Temperature: -35°C to +66°C

Maximum Humidity: 95%

Flammability: UL94 V2

Materials

Face: Nylon

Body: Nylon

Contacts: .03" Brass (.8)

Mounting Strap: .05" Zinc-Plated Steel (1.3)

Terminal Screws: Steel #8 - 32

Flat Head Mounting Screws: Zinc-Plated Steel

Test/Reset Buttons: Nylon

Project

Location/Type

TECHNICAL SPECIFICATIONS

PlugTail® Specification Grade Self-Test GFCI Receptacles

2 Pole, 3 Wire Grounding 15 & 20A, 125VAC

Typical Specifications

Manufacturer's Identification: Pass & Seymour® PT1597

Description: PlugTail® Straight Blade Duplex Self-Test GFCI Receptacle

Type: 2 Pole, 3 Wire Grounding

Rating: 15 or 20A, 125VAC Face

3rd Party Compliance: cULus Listed File Number E42190 and E140596, Standard UL498 Attachment Plugs and Receptacles, UL943 GFCIs. Federal Specification WC596. Standard CSA C22.2 No. 42 General Use Receptacles, CSA C22.2 No. 144 GFCIs. Conforms to NEMA WD-1 and WD-6.

CATALOG NUMBER	COLOR	RATING	NEMA CONFIG. NO.
<input type="checkbox"/> PT1597I	Ivory	15A 125VAC	5-15R
<input type="checkbox"/> PT1597W	White	15A 125VAC	5-15R
<input type="checkbox"/> PT1597GRY	Gray	15A 125VAC	5-15R
<input type="checkbox"/> PT1597LA	Light Almond	15A 125VAC	5-15R
<input type="checkbox"/> PT2097I	Ivory	20A 125VAC	5-20R
<input type="checkbox"/> PT2097W	White	20A 125VAC	5-20R
<input type="checkbox"/> PT2097	Brown	20A 125VAC	5-20R
<input type="checkbox"/> PT2097GRY	Gray	20A 125VAC	5-20R
<input type="checkbox"/> PT2097BK	Black	20A 125VAC	5-20R
<input type="checkbox"/> PT2097RED	Red	20A 125VAC	5-20R
<input type="checkbox"/> PT2097LA	Light Almond	20A 125VAC	5-20R

Performance

Electrical

Dielectric:	Withstands 1500V minimum
Trip Level:	4 to 6 mA
Trip Time:	.025 Second Nominal
Frequency:	60 Hz
Voltage:	125VAC
Voltage Range:	102-132VAC

Mechanical

Indicator Light (LED):	Red, ON when GFCI is tripped
PlugTail Connector Identification:	#12 AWG, THHN, copper conductor, 6" leads, stripped, solid or stranded, for use with PlugTail Receptacles only
Product Identification:	Ratings are a permanent part of the device

Environmental

Operating Temperature:	-35°C to +66°C
Maximum Humidity:	95%
Flammability:	UL94 V2

PlugTail® GFCI Receptacle Materials

Face:	Nylon	Mounting Strap:	.05" Zinc-Plated Steel (1.3)
Body:	Nylon	Flat Head	
Contacts:	.03" Brass (.8)	Mounting Screws:	Zinc-Plated Steel
		Test/Reset Buttons:	Nylon

PlugTail Connector Materials

Housing:	Polycarbonate	Contacts:	.030" Brass
----------	---------------	-----------	-------------

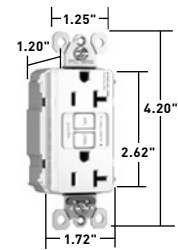

Dimensions for
15 & 20 Amp



PTRA6STR

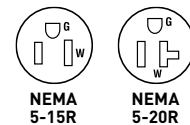

NEMA
5-15R

NEMA
5-20R

Project
Location/Type

TECHNICAL SPECIFICATIONS

PlugTail® Hospital Grade Self-Test GFCI Receptacles

2 Pole, 3 Wire Grounding 15 & 20A, 125VAC

Typical Specifications

Manufacturer's Identification: Pass & Seymour® PT1597HG

Description: PlugTail® Straight Blade Duplex Hospital Grade Self-Test GFCI Receptacle

Type: 2 Pole, 3 Wire Grounding

Rating: 15 or 20A, 125VAC Face

3rd Party Compliance: cULus Listed File Number E42190 and E140596, Standard UL498 Attachment Plugs and Receptacles, UL943 GFCIs. Federal Specification WC596, Hospital Grade. Standard CSA C22.2 No. 42 General Use Receptacles, CSA C22.2 No. 144 GFCIs. Conforms to NEMA WD-1 and WD-6.

CATALOG NUMBER	COLOR	RATING	NEMA CONFIG. NO.
<input type="checkbox"/> PT1597HGW	White	15A 125VAC	5-15R
<input type="checkbox"/> PT1597HGRED	Red	15A 125VAC	5-15R
<input type="checkbox"/> PT1597HGLA	Light Almond	15A 125VAC	5-15R
<input type="checkbox"/> PT2097HGI	Ivory	20A 125VAC	5-20R
<input type="checkbox"/> PT2097HGW	White	20A 125VAC	5-20R
<input type="checkbox"/> PT2097HG	Brown	20A 125VAC	5-20R
<input type="checkbox"/> PT2097HGGRY	Gray	20A 125VAC	5-20R
<input type="checkbox"/> PT2097HGBK	Black	20A 125VAC	5-20R
<input type="checkbox"/> PT2097HGRED	Red	20A 125VAC	5-20R
<input type="checkbox"/> PT2097HGLA	Light Almond	20A 125VAC	5-20R

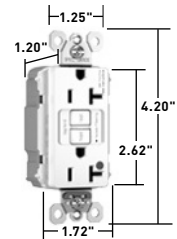

Dimensions for
15 & 20 Amp

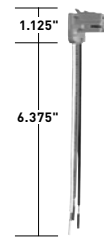

PTRA65TR

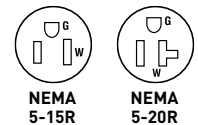

Performance

Electrical

Dielectric: Withstands 1500V minimum

Trip Level: 4 to 6 mA

Trip Time: .025 Second Nominal

Frequency: 60 Hz

Voltage: 125VAC

Voltage Range: 102-132VAC

Mechanical

Indicator Light (LED): Red, ON when GFCI is tripped

PlugTail Connector Identification: #12 AWG, THHN, copper conductor, 6" leads, stripped, solid or stranded, for use with PlugTail Receptacles only

Product Identification: Ratings are a permanent part of the device

Environmental

Operating Temperature: -35°C to +66°C

Maximum Humidity: 95%

Flammability: UL94 V2

PlugTail GFCI Receptacle Materials

Face: Nylon Mounting Strap: .05" Zinc-Plated Steel (1.3)

Body: Nylon Flat Head

Contacts: .03" Brass (.8) Mounting Screws: Zinc-Plated Steel

Test/Reset Buttons: Nylon

PlugTail Connector Materials

Housing: Polycarbonate Contacts: .030" Brass

Project
Location/Type

TECHNICAL SPECIFICATIONS

PlugTail® Specification Grade Tamper-Resistant Self-Test GFCI Receptacles

2 Pole, 3 Wire Grounding 15 & 20A, 125VAC

Typical Specifications

Manufacturer's Identification: Pass & Seymour® PT1597NTL

Description: PlugTail® Straight Blade Duplex Tamper-Resistant Self-Test GFCI Receptacle

Type: 2 Pole, 3 Wire Grounding

Rating: 15 or 20A, 125VAC Face

3rd Party Compliance: cULus Listed File Number E42190 and E140596, Standard UL498 Tamper-Resistant, Attachment Plugs and Receptacles, UL943 GFCIs. Federal Specification WC596. Standard CSA C22.2 No. 42 General Use Receptacles, CSA C22.2 No. 144 GFCIs. Conforms to NEMA WD-1 and WD-6.

CATALOG NUMBER	COLOR	RATING	NEMA CONFIG. NO.
<input type="checkbox"/> PT1597TRI	Ivory	15A 125VAC	5-15R
<input type="checkbox"/> PT1597TRW	White	15A 125VAC	5-15R
<input type="checkbox"/> PT1597TRGRY	Gray	15A 125VAC	5-15R
<input type="checkbox"/> PT1597TRRED	Red	15A 125VAC	5-15R
<input type="checkbox"/> PT1597TRLA	Light Almond	15A 125VAC	5-15R
<input type="checkbox"/> PT2097TRI	Ivory	20A 125VAC	5-20R
<input type="checkbox"/> PT2097TRW	White	20A 125VAC	5-20R
<input type="checkbox"/> PT2097TR	Brown	20A 125VAC	5-20R
<input type="checkbox"/> PT2097TRGRY	Gray	20A 125VAC	5-20R
<input type="checkbox"/> PT2097TRRED	Red	20A 125VAC	5-20R
<input type="checkbox"/> PT2097TRLA	Light Almond	20A 125VAC	5-20R

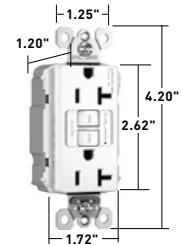

Dimensions for
15 & 20 Amp



PTRA6STR

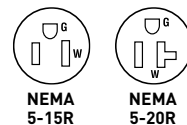

NEMA
5-15R

NEMA
5-20R

Performance

Electrical

Dielectric: Withstands 1500V minimum

Trip Level: 4 to 6 mA

Trip Time: .025 Second Nominal

Frequency: 60 Hz

Voltage: 125VAC

Voltage Range: 102-132VAC

Mechanical

Indicator Light (LED): Red, ON when GFCI is tripped

PlugTail Connector Identification: #12 AWG, THHN, copper conductor, 6" leads, stripped, solid or stranded, for use with PlugTail Receptacles only

Product Identification: Ratings are a permanent part of the device

Environmental

Operating Temperature: -35°C to +66°C

Maximum Humidity: 95%

Flammability: UL94 V2

PlugTail® GFCI Receptacle Materials

Face: Nylon

Body: Nylon

Contacts: .03" Brass (.8)

Mounting Strap: .05" Zinc-Plated Steel (1.3)

Flat Head Mounting Screws: Zinc-Plated Steel

Test/Reset Buttons: Nylon

Tamper-Resistant Shutter: Thermoplastic

PlugTail Connector Materials

Housing: Polycarbonate

Contacts: .030" Brass

Project
Location/Type

TECHNICAL SPECIFICATIONS

PlugTail® Hospital Grade Tamper-Resistant Self-Test GFCI Receptacles

2 Pole, 3 Wire Grounding 15 & 20A, 125VAC

Typical Specifications

Manufacturer's Identification: Pass & Seymour® PT1597HGTR

Description: PlugTail® Straight Blade Duplex Hospital Grade Tamper-Resistant Self-Test GFCI Receptacle

Type: 2 Pole, 3 Wire Grounding

Rating: 15 or 20A, 125VAC Face

3rd Party Compliance: cULus Listed File Number E42190 and E140596, Standard UL498 TamperResistant, Attachment Plugs and Receptacles, UL943 GFCIs. Federal Specification WC596 Hospital Grade. Standard CSA C22.2 No. 42 General Use Receptacles, CSA C22.2 No. 144 GFCIs.

Conforms to NEMA WD-1 and WD-6.

CATALOG NUMBER	COLOR	RATING	NEMA CONFIG. NO.
<input type="checkbox"/> PT1597HGTRI	Ivory	15A 125VAC	5-15R
<input type="checkbox"/> PT1597HGTRW	White	15A 125VAC	5-15R
<input type="checkbox"/> PT1597HGTRRED	Red	15A 125VAC	5-15R
<input type="checkbox"/> PT1597HGTRLA	Light Almond	15A 125VAC	5-15R
<input type="checkbox"/> PT2097HGTRI	Ivory	20A 125VAC	5-20R
<input type="checkbox"/> PT2097HGTRW	White	20A 125VAC	5-20R
<input type="checkbox"/> PT2097HGTRGRY	Gray	20A 125VAC	5-20R
<input type="checkbox"/> PT2097HGTRBK	Black	20A 125VAC	5-20R
<input type="checkbox"/> PT2097HGTRRED	Red	20A 125VAC	5-20R
<input type="checkbox"/> PT2097HGTRLA	Light Almond	20A 125VAC	5-20R

Performance

Electrical

Dielectric: Withstands 1500V minimum

Trip Level: 4 to 6 mA

Trip Time: .025 Second Nominal

Frequency: 60 Hz

Voltage: 125VAC

Voltage Range: 102-132VAC

Mechanical

Indicator Light (LED): Red, ON when GFCI is tripped

PlugTail Connector Identification: #12 AWG, THHN, copper conductor, 6" leads, stripped, solid or stranded, for use with PlugTail Receptacles only

Product Identification: Ratings are a permanent part of the device

Environmental

Operating Temperature: -35°C to +66°C

Maximum Humidity: 95%

Flammability: UL94 V2

PlugTail® GFCI Receptacle Materials

Face: Nylon

Body: Nylon

Contacts: .03" Brass (.8)

Mounting Strap: .05" Zinc-Plated Steel (1.3)

Flat Head Mounting Screws: Zinc-Plated Steel

Test/Reset Buttons: Nylon

Tamper-Resistant Shutter: Thermoplastic

PlugTail Connector Materials

Housing: Polycarbonate

Contacts: .030" Brass

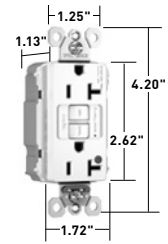

Dimensions for
15 & 20 Amp

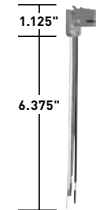

PTR6STR

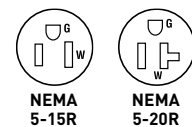

NEMA
5-15R

NEMA
5-20R

Project
Location/Type

TECHNICAL SPECIFICATIONS

PlugTail® Specification Grade Tamper-Resistant Nightlight/Self-Test GFCI Receptacles

2 Pole, 3 Wire Grounding 15 & 20A, 125VAC

Typical Specifications

Manufacturer's Identification: Pass & Seymour® PT2097NTL

Description: PlugTail® Straight Blade Duplex Tamper-Resistant Nightlight/Self-Test GFCI Receptacle

Type: 2 Pole, 3 Wire Grounding

Rating: 15 or 20A, 125VAC Face

3rd Party Compliance: cULus Listed File Number E42190 and E140596, Standard UL498 Tamper-Resistant, Attachment Plugs and Receptacles, UL943 GFCIs. Federal Specification WC596. Standard CSA C22.2 No. 42 General Use Receptacles, CSA C22.2 No. 144 GFCIs. Conforms to NEMA WD-1 and WD-6.

CATALOG NUMBER	COLOR	RATING	NEMA CONFIG. NO.
<input type="checkbox"/> PT2097NTLTRI	Ivory	20A 125VAC	5-20R
<input type="checkbox"/> PT2097NTLTRW	White	20A 125VAC	5-20R

Performance

Electrical

Dielectric: Withstands 1500V minimum

Trip Level: 4 to 6 mA

Trip Time: .025 Second Nominal

Frequency: 60 Hz

Voltage: 125VAC

Voltage Range: 102-132VAC

Mechanical

Indicator Light (LED): Red, ON when GFCI is tripped

PlugTail Connector Identification: #12 AWG, THHN, copper conductor, 6" leads, stripped, solid or stranded, for use with PlugTail Receptacles only

Product Identification: Ratings are a permanent part of the device

Environmental

Operating Temperature: -35°C to +66°C

Maximum Humidity: 95%

Flammability: UL94 V2

PlugTail® GFCI Receptacle Materials

Face: Nylon

Body: Nylon

Contacts: .03" Brass (.8)

Mounting Strap: .05" Nickel-Plated Steel (1.3)

Flat Head Mounting Screws: Zinc-Plated Steel

Test/Reset Buttons: Nylon

Nightlight Lens: Lexan®

Tamper-Resistant Shutter: Thermoplastic

PlugTail Connector Materials

Housing: Polycarbonate

Contacts: .030" Brass

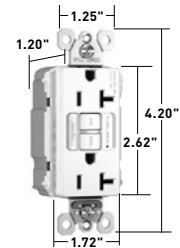

Dimensions for
20 Amp



PTRA6STR

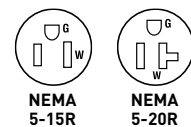

NEMA
5-15R

NEMA
5-20R

Project
Location/Type

TECHNICAL SPECIFICATIONS

PlugTail® Hospital Grade Tamper-Resistant Nightlight/Self-Test GFCI Receptacles

2 Pole, 3 Wire Grounding 15 & 20A, 125VAC

Typical Specifications

Manufacturer's Identification: Pass & Seymour® PT1597HG

Description: PlugTail® Straight Blade Duplex Hospital Grade Tamper-Resistant Nightlight/Self-Test GFCI Receptacle

Type: 2 Pole, 3 Wire Grounding

Rating: 15 or 20A, 125VAC Face

3rd Party Compliance: cULus Listed File Number E42190 and E140596, Standard UL498 Attachment Plugs and Receptacles, UL943 GFCIs. Federal Specification WC596, Hospital Grade. Standard CSA C22.2 No. 42 General Use Receptacles, CSA C22.2 No. 144 GFCIs. Conforms to NEMA WD-1 and WD-6.

CATALOG NUMBER	COLOR	RATING	NEMA CONFIG. NO.
<input type="checkbox"/> PT1597HGNTLTRI	Ivory	15A 125VAC	5-15R
<input type="checkbox"/> PT1597HGNTLTRRED	Red	15A 125VAC	5-15R
<input type="checkbox"/> PT2097HGNTLTRI	Ivory	20A 125VAC	5-20R
<input type="checkbox"/> PT2097HGNTLTRW	White	20A 125VAC	5-20R
<input type="checkbox"/> PT2097HGNTLTRGRY	Gray	20A 125VAC	5-20R
<input type="checkbox"/> PT2097HGNTLTRLA	Light Almond	20A 125VAC	5-20R

Performance

Electrical

Dielectric:	Withstands 1500V minimum
Trip Level:	4 to 6 mA
Trip Time:	.025 Second Nominal
Frequency:	60 Hz
Voltage:	125VAC
Voltage Range:	102-132VAC

Mechanical

Indicator Light (LED):	Red, ON when GFCI is tripped
PlugTail Connector Identification:	#12 AWG, THHN, copper conductor, 6" leads, stripped, solid or stranded, for use with PlugTail Receptacles only
Product Identification:	Ratings are a permanent part of the device

Environmental

Operating Temperature:	-35°C to +66°C
Maximum Humidity:	95%
Flammability:	UL94 V2

PlugTail® GFCI Receptacle Materials

Face:	Nylon
Body:	Nylon
Contacts:	.03" Brass (.8)
Mounting Strap:	.05" Zinc-Plated Steel (1.3)
Flat Head Mounting Screws:	Zinc-Plated Steel
Test/Reset Buttons:	Nylon
Nightlight Lens:	Lexan®

PlugTail Connector Materials

Housing:	Polycarbonate
Contacts:	.030" Brass

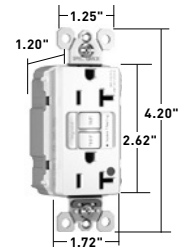

Dimensions for
15 & 20 Amp

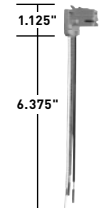

PTR6STR

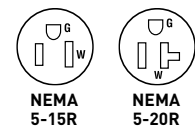

Project

Location/Type

TECHNICAL SPECIFICATIONS

NAFTA-Compliant & RoHS-Compliant Self-Test GFCI Receptacles

2 Pole, 3 Wire Grounding 15 & 20A, 125VAC

Typical Specifications

Manufacturer's Identification: Pass & Seymour® 1597TRNA, 1597NA, 1597R
 Description: Straight Blade Duplex NAFTA-Compliant Self-Test GFCI Receptacle, Duplex NAFTA-Compliant Tamper-Resistant Self-Test GFCI Receptacle & Duplex RoHS-Compliant Self-Test GFCI Receptacle
 Type: 2 Pole, 3 Wire Grounding
 Rating: 20A, 125VAC Feed Thru; 15 or 20A, 125VAC Face
 3rd Party Compliance: cULus Listed, File Number E42190; Standard UL498, Attachment Plugs and Receptacles UL943 GFCIs. Federal Specification WC596. Standard CSA-C22.2 No. 42, General Use Receptacles, CSA-C22.2 No. 144 GFCIs. Conforms to NEMA WD-1 and WD-6.

CATALOG NUMBER	COLOR	RATING	NEMA CONFIG. NO.	CATALOG NUMBER	COLOR	RATING	NEMA CONFIG. NO.
□ 1597TRNAI	Ivory	15A 125VAC	5-15R	□ 2097NAI	Ivory	20A 125VAC	5-20R
□ 1597TRNAW	White	15A 125VAC	5-15R	□ 2097NAW	White	20A 125VAC	5-20R
□ 1597TRNAGRY	Gray	15A 125VAC	5-15R	□ 2097NA	Brown	20A 125VAC	5-20R
□ 1597TRNALA	Lt. Almond	15A 125VAC	5-15R	□ 2097NAGRY	Gray	20A 125VAC	5-20R
□ 2097TRNAI	Ivory	20A 125VAC	5-20R	□ 2097NALA	Lt. Almond	20A 125VAC	5-20R
□ 2097TRNAW	White	20A 125VAC	5-20R	□ 2097NABL	Blue	20A 125VAC	5-20R
□ 2097TRNAGRY	Gray	20A 125VAC	5-20R	□ 1597TRRI	Ivory	15A 125VAC	5-15R
□ 2097TRNALA	Lt. Almond	20A 125VAC	5-20R	□ 1597TRRW	White	15A 125VAC	5-15R
				□ 1597TRRLA	Lt. Almond	15A 125VAC	5-15R
				□ 2097TRRI	Ivory	20A 125VAC	5-20R

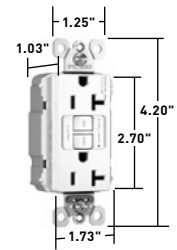

Dimensions for 15 & 20 Amp

Performance

Electrical

Dielectric: Withstands 1500V minimum
 Trip Level: 4 to 6 mA
 Trip Time: .025 Second Nominal
 Frequency: 60 Hz
 Voltage: 125VAC
 Voltage Range: 102-132VAC

Mechanical

Indicator Light (LED): Red, ON when GFCI is tripped
 Terminal Identification: Terminals identified in accordance with UL498 (Hot, White, Green)
 Terminal Accommodation: #14 - #10 AWG solid or stranded copper conductor only
 Product Identification: Ratings are a permanent part of device

Environmental

Operating Temperature: -35°C to +66°C
 Maximum Humidity: 95%
 Flammability: UL94 V2

Materials

Face: Nylon
 Body: Nylon
 Contacts: .03" Brass (.8)
 Mounting Strap: .05" Zinc-Plated Steel (1.3)
 Terminal Screws: Steel #8 - 32
 Hex Head Grounding Screw: Steel (Green)
 Flat Head Mounting Screw: Zinc-Plated Steel
 Test/Reset Buttons: Nylon
 Tamper-Resistant Shutter*: Thermoplastic

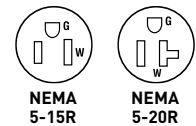

TECHNICAL SPECIFICATIONS

NAFTA-Compliant GFCI Self-Test Receptacles are ideal for use on projects subject to the provisions of the Buy American Act.
 RoHS-Compliant GFCI Self-Test Receptacles meet the requirements of Restriction of Hazardous Substances directives and regulations.

Project
Location/Type

TECHNICAL SPECIFICATIONS

NAFTA-Compliant Hospital Grade Self-Test GFCI Receptacles 2 Pole, 3 Wire Grounding 15 & 20A, 125VAC

Typical Specifications

Manufacturer's Identification: Pass & Seymour® 2097HGTRNA, 1597HGTRNA
 Description: Straight Blade Duplex Hospital Grade NAFTA-Compliant Self-Test GFCI Receptacle & Duplex
 Tamper-Resistant Hospital Grade NAFTA-Compliant Self-Test GFCI Receptacle
 Type: 2 Pole, 3 Wire Grounding
 Rating: 20A, 125VAC Feed Thru; 15 or 20A, 125VAC Face
 3rd Party Compliance: cULus Listed, File Number E42190, Standard UL498, Attachment Plugs and Receptacles
 UL943 GFCIs. Federal Specification WC596 Hospital Grade. Standard CSA-C22.2 No. 42, General Use
 Receptacles, CSA-C22.2 No. 144 GFCIs. Conforms to NEMA WD-1 and WD-6.

CATALOG NUMBER	COLOR	RATING	NEMA CONFIG. NO.
<input type="checkbox"/> 2097HGTRNAI	Ivory	20A 125VAC	5-20R
<input type="checkbox"/> 2097HGTRNAW	White	20A 125VAC	5-20R
<input type="checkbox"/> 2097HGTRNARE	Red	20A 125VAC	5-20R
<input type="checkbox"/> 2097HGTRNALA	Light Almond	20A 125VAC	5-20R
<input type="checkbox"/> 2097HGNAI	Ivory	20A 125VAC	5-20R
<input type="checkbox"/> 2097HGNAW	White	20A 125VAC	5-20R
<input type="checkbox"/> 2097HGNAGRY	Gray	20A 125VAC	5-20R
<input type="checkbox"/> 2097HGNARED	Red	20A 125VAC	5-20R
<input type="checkbox"/> 2097HGNALA	Light Almond	20A 125VAC	5-20R

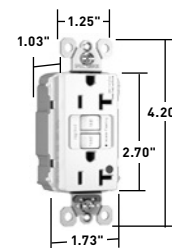

Dimensions for
20 Amp

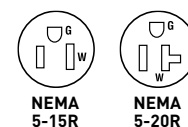

Performance

Electrical

Dielectric: Withstands 1500V minimum
 Trip Level: 4 to 6 mA
 Trip Time: .025 Second Nominal
 Frequency: 60 Hz
 Voltage: 125VAC
 Voltage Range: 102-132VAC

Mechanical

Indicator Light (LED): Red, ON when GFCI is tripped
 Terminal Identification: Terminals identified in accordance with UL498 (Hot, White, Green)
 Terminal Accommodation: #14 - #10 AWG solid or stranded copper conductor only
 Product Identification: Ratings are a permanent part of the device

Environmental

Operating Temperature: -35°C to +66°C
 Maximum Humidity: 95%
 Flammability: UL94 V2

Materials

Face:	Nylon	Hex Head Grounding Screw:	Steel (Green)
Body:	Nylon	Flat Head Mounting Screw:	Zinc-Plated Steel
Contacts:	.03" Brass (.8)	Test/Reset Buttons:	Nylon
Mounting Strap:	.05" Zinc-Plated Steel (1.3)	Tamper-Resistant Shutter*:	Thermoplastic
Terminal Screws:	Steel #8 - 32		

NAFTA-Compliant Self-Test GFCI Receptacles are ideal for use on projects subject to the provisions of the Buy American Act.

Project
Location/Type

TECHNICAL SPECIFICATIONS

NAFTA-Compliant PlugTail® Self-Test GFCI Receptacles 2 Pole, 3 Wire Grounding 15 & 20A, 125VAC

Typical Specifications

Manufacturer's Identification: Pass & Seymour® PT1597NA, PT1597TRNA
 Description: PlugTail® Straight Blade Duplex NAFTA-Compliant Self-Test GFCI Receptacle & Straight Blade Duplex Tamper-Resistant NAFTA-Compliant Self-Test GFCI Receptacle
 Type: 2 Pole, 3 Wire Grounding
 Rating: 15 or 20A, 125VAC Face
 3rd Party Compliance: cULus Listed File Number E42190 and E140596, Standard UL498, Attachment Plugs and Receptacles, UL943 GFCIs. Federal Specification WC596. Standard CSA C22.2 No. 42 General Use Receptacles, CSA C22.2 No. 144 GFCIs. Conforms to NEMA WD-1 and WD-6.

CATALOG NUMBER	COLOR	RATING	NEMA CONFIG. NO.
<input type="checkbox"/> PT1597NAW	White	15A 125VAC	5-15R
<input type="checkbox"/> PT1597NAGRY	Gray	15A 125VAC	5-15R
<input type="checkbox"/> PT1597NALA	Light Almond	15A 125VAC	5-15R
<input type="checkbox"/> PT2097NAW	White	20A 125VAC	5-20R
<input type="checkbox"/> PT2097NABK	Black	20A 125VAC	5-20R
<input type="checkbox"/> PT2097NALA	Light Almond	20A 125VAC	5-20R
<input type="checkbox"/> PT2097TRNAI	Ivory	20A 125VAC	5-20R
<input type="checkbox"/> PT2097TRNAW	White	20A 125VAC	5-20R
<input type="checkbox"/> PT2097TRNALA	Light Almond	20A 125VAC	5-20R
<input type="checkbox"/> PT1597NTLTRNAW	White	15A 125VAC	5-15R
<input type="checkbox"/> PT2097NTLTRNAI	Ivory	20A 125VAC	5-20R
<input type="checkbox"/> PT2097NTLTRNAW	White	20A 125VAC	5-20R

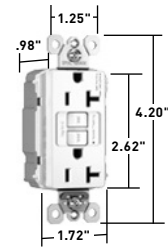

Dimensions for 15 & 20 Amp

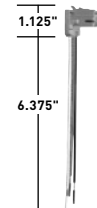

PTRA6STR

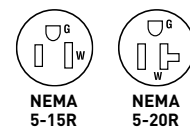

Performance

Electrical

Dielectric: Withstands 1500V minimum
 Trip Level: 4 to 6 mA
 Trip Time: .025 Second Nominal
 Frequency: 60 Hz
 Voltage: 125VAC
 Voltage Range: 102-132VAC

Mechanical

Indicator Light (LED): Red, ON when GFCI is tripped
 PlugTail Connector Identification: #12 AWG, THHN, copper conductor, 6" leads, stripped, solid or stranded, for use with PlugTail Receptacles only
 Ratings are a permanent part of the device

Product Identification:

Environmental

Operating Temperature: -35°C to +66°C
 Maximum Humidity: 95%
 Flammability: UL94 V2

PlugTail® GFCI Receptacle Materials

Face: Nylon
 Body: Nylon
 Contacts: .03" Brass (.8)
 Mounting Strap: .05" Zinc-Plated Steel (1.3)
 Flat Head Mounting Screws: Zinc-Plated Steel
 Test/Reset Buttons: Nylon
 Tamper-Resistant Shutter: Thermoplastic

PlugTail Connector Materials

Housing: Polycarbonate Contacts: .030" Brass

NAFTA-Compliant Self-Test GFCI Receptacles are ideal for use on projects subject to the provisions of the Buy American Act.

Project
Location/Type

TECHNICAL SPECIFICATIONS

NAFTA-Compliant PlugTail® Hospital Grade Self-Test GFCI Receptacles

15 & 20A, 125VAC 2 Pole, 3 Wire Grounding

Typical Specifications

Manufacturer's Identification: Pass & Seymour® PT1597HG

Description: PlugTail® Straight Blade Duplex Hospital Grade NAFTA-Compliant Self-Test GFCI Receptacle, Straight Blade Duplex Hospital Grade Tamper-Resistant NAFTA-Compliant Self-Test GFCI Receptacle & Straight Blade Duplex Tamper-Resistant NAFTA-Compliant Nightlight/Self-Test GFCI Receptacle

Type: 2 Pole, 3 Wire Grounding

Rating: 15 or 20A, 125VAC Face

3rd Party Compliance: cULus Listed File Number E42190 and E140596, Standard UL498, Attachment Plugs and Receptacles, UL943 GFCIs. Federal Specification WC596, Hospital Grade. Standard CSA C22.2 No. 42 General Use Receptacles, CSA C22.2 No. 144 GFCIs. Conforms to NEMA WD-1 and WD-6.

CATALOG NUMBER	COLOR	RATING	NEMA CONFIG. NO.
<input type="checkbox"/> PT2097HGNAI	Ivory	20A 125VAC	5-20R
<input type="checkbox"/> PT2097HGNAW	White	20A 125VAC	5-20R
<input type="checkbox"/> PT2097HGNAGRY	Gray	20A 125VAC	5-20R
<input type="checkbox"/> PT2097HGNARED	Red	20A 125VAC	5-20R
<input type="checkbox"/> PT2097HGTRNAI	Ivory	20A 125VAC	5-20R
<input type="checkbox"/> PT2097HGTRNAW	White	20A 125VAC	5-20R
<input type="checkbox"/> PT2097HGTRNAGRY	Gray	20A 125VAC	5-20R
<input type="checkbox"/> PT2097HGNTLTRNAI	Ivory	20A 125VAC	5-20R

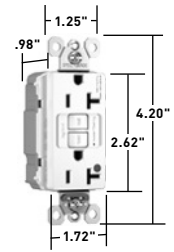

Dimensions for
20 Amp

Performance

Electrical

Dielectric:	Withstands 1500V minimum
Trip Level:	4 to 6 mA
Trip Time:	.025 Second Nominal
Frequency:	60 Hz
Voltage:	125VAC
Voltage Range:	102-132VAC

Mechanical

Indicator Light (LED):	Red, ON when GFCI is tripped
PlugTail Connector Identification:	#12 AWG, THHN, copper conductor, 6" leads, stripped, solid or stranded, for use with PlugTail Receptacles only
Product Identification:	Ratings are a permanent part of the device

Environmental

Operating Temperature:	-35°C to +66°C
Maximum Humidity:	95%
Flammability:	UL94 V2

PlugTail® GFCI Receptacle Materials

Face:	Nylon	Flat Head Mounting Screws:	Zinc-Plated Steel
Body:	Nylon	Test/Reset Buttons:	Nylon
Contacts:	.03" Brass (.8)	Tamper-Resistant Shutter:	Thermoplastic
Mounting Strap:	.05" Zinc-Plated Steel (1.3)		

PlugTail® Connector Materials

Housing:	Polycarbonate	Contacts:	.030" Brass
----------	---------------	-----------	-------------

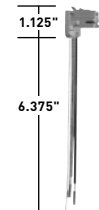

PTRA6STR

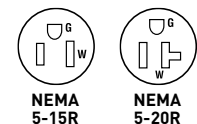

NAFTA-Compliant Self-Test GFCI Receptacles are ideal for use on projects subject to the provisions of the Buy American Act.

Project
Location/Type

TECHNICAL SPECIFICATIONS

Hospital Grade Surge Protective Receptacles

2 Pole, 3 Wire Grounding 15 & 20A, 125VAC

Typical Specifications

Manufacturer's Identification: Pass & Seymour® 8200ISP
 3rd Party Compliance: UL Listed, File Number E140596, Standard UL498, Attachment Plugs and Receptacles UL1449 Transient Voltage Surge Suppressor. Federal Specification WC596. CSA Certified, File Number LR16063, Standard CSA-C22.2 No. 42, ANSI/IEEE C62.41 (Formerly IEEE 587), ANSI/IEEE C62.45 Installation Categories "A" (Ring Wave) "B" (Unidirectional Impulse). Complies with NEC 410-56(c) and 250-74 exception 4. Conforms to NEMA WD-1 and WD-6.

CATALOG NUMBER	COLOR	RATING	NEMA CONFIG. NO.	CATALOG NUMBER	COLOR	RATING	NEMA CONFIG. NO.
8200ISP	Ivory	15A 125VAC	5-15R	8300ISP	Ivory	20A 125VAC	5-20R
8200WSP	White	15A 125VAC	5-15R	8300WSP	White	20A 125VAC	5-20R
8200SP	Brown	15A 125VAC	5-15R	8300SP	Brown	20A 125VAC	5-20R
8200REDSP	Red	15A 125VAC	5-15R	8300GRYSP	Gray	20A 125VAC	5-20R
8200BLSP	Blue	15A 125VAC	5-15R	8300REDSP	Red	20A 125VAC	5-20R
				8300LASP	Lt. Almond	20A 125VAC	5-20R
				8300BLSP	Blue	20A 125VAC	5-20R

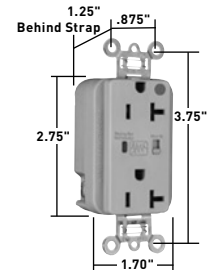

8300GRYSP

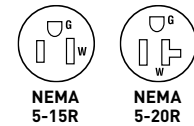

Performance

Electrical

Frequency:	60 Hz
Voltage:	125VAC
MOV Rating:	130V 17mm Dual Pack
Suppressed Voltage:	500V
Energy Rating:	340 Joules
Max Surge Capability:	24kA
Protection Modes:	Normal and Common Modes; Normal Mode (L-N) 500V Clamping; Common Mode (L-G) 500V Clamping, (N-G) 500V Clamping
Noise Attenuation:	Normal Mode (L-N) Capacitance Value = 0.0056 µF 7:1 Average Noise Reduction
Thermal Protection:	Three Thermal Fuses (128°C or 262°F)
Overcurrent Protection	Three Fuses Protects 3 Modes
Operating Temperature:	-20°C to 55°C (-4 to 131°F)
Storage Temperature:	-40°C to 85°C (-40 to 185°F)

Mechanical

Terminal Identification:	Brass = Hot, Nickel = Neutral, Green = Ground
Terminal Accommodation:	#14 - 10 AWG copper conductor only
Product Identification:	Ratings are a permanent part of device
Weight:	125 grams

Environmental

Flammability:	UL94 V2
---------------	---------

Materials

Face:	Nylon	Terminal Screws:	Tri-Drive Brass #8 - 32
Body:	Nylon	Hex Head Grounding Screw:	Tri-Drive Steel (Green)
Line Terminal:	Olin #260 EH, 0.8mm thick	Auto-Ground Clip:	Stainless Steel
Grounding Terminal:	70/30 Brass, 0.4mm thick	Mounting Screws:	Tri-Drive Zinc-Plated Steel
(Uni-Ground Assembly)		LED:	Green/Red
Mounting Strap:	Super Dyma Cold-Rolled Steel, 1.2mm thick	Encapsulation:	Conformal Coating
Clamping Plate:	Cold-Rolled Steel, 1.6mm		

Warranty:

1 year

Conforms to the latest revision ANSI/IEEE C62.41 (formerly IEEE587), ANSI/IEEE C62.45.

Project
Location/Type

TECHNICAL SPECIFICATIONS

TECHNICAL SPECIFICATIONS

Hospital Grade Isolated Ground Surge Protective Receptacles

2 Pole, 3 Wire Grounding 15 & 20A, 125VAC

Typical Specifications

Manufacturer's Identification: Pass & Seymour® IG8200ISP
 3rd Party Compliance: UL Listed, File Number E140596, Standard UL498, Attachment Plugs and Receptacles UL1449 Transient Voltage Surge Suppressor. Federal Specification WC596. CSA Certified, File Number LR16063, Standard CSA-C22.2 No. 42, ANSI/IEEE C62.41 (Formerly IEEE 587), ANSI/IEEE C62.45 Installation Categories "A" (Ring Wave) "B" (Unidirectional Impulse). Complies with NEC 410-56(c) & 250-74 exception 4. Conforms to NEMA WD-1 and WD-6.

CATALOG NUMBER	COLOR	RATING	NEMA CONFIG. NO.	CATALOG NUMBER	COLOR	RATING	NEMA CONFIG. NO.
<input type="checkbox"/> IG8200ISP	Ivory	15A 125VAC	5-15R	<input type="checkbox"/> IG8300ISP	Ivory	20A 125VAC	5-20R
<input type="checkbox"/> IG8200WSP	White	15A 125VAC	5-15R	<input type="checkbox"/> IG8300WSP	White	20A 125VAC	5-20R
<input type="checkbox"/> IG8200BLSP	Blue	15A 125VAC	5-15R	<input type="checkbox"/> IG8300GRYSP	Gray	20A 125VAC	5-20R
<input type="checkbox"/> IG8200OSP	Orange	15A 125VAC	5-15R	<input type="checkbox"/> IG8300BLSP	Blue	20A 125VAC	5-20R
				<input type="checkbox"/> IG8300OSP	Orange	20A 125VAC	5-20R

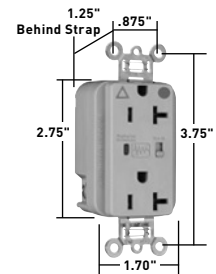

IG8300GRYSP

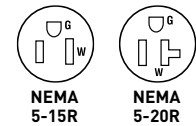

Performance

Electrical

Frequency:	60 Hz
Voltage:	125VAC
MOV Rating:	130V 17mm Dual Pack
Suppressed Voltage:	500V
Energy Rating:	340 Joules
Max Surge Capability:	24kA
Protection Modes:	Normal and Common Modes: Normal Mode (L-N) 500V Clamping; Common Mode (L-G) 500V Clamping, (N-G) 500V Clamping
Noise Attenuation:	Normal Mode (L-N) Capacitance Value = 0.0056 µF 7:1 Average Noise Reduction
Thermal Protection:	Three Thermal Fuses (128°C or 262°F)
Overcurrent Protection:	Three Fuses Protects 3 Modes
Operating Temperature:	-20°C to 55°C (-4 to 131°F)
Storage Temperature:	-40°C to 85°C (-40 to 185°F)

Mechanical

Terminal Identification:	Brass = Hot, Nickel = Neutral, Green = Ground
Terminal Accommodation:	#14 – 10 AWG copper conductor only
Product Identification:	Ratings are a permanent part of device
Weight:	125 grams

Environmental

Flammability:	UL94 V2
---------------	---------

Materials

Face:	Nylon	Terminal Screws:	Tri-Drive Brass #8 - 32
Body:	Nylon	Hex Head Grounding Screw:	Tri-Drive Steel (Green)
Line Terminal:	Olin #260 EH, 0.8mm thick	Auto-Ground Clip:	Stainless Steel
Grounding Terminal:	70/30 Brass, 0.4mm thick	Mounting Screws:	Tri-Drive Zinc-Plated Steel
(Uni-Ground Assembly)		LED:	Green/Red
Mounting Strap:	Super Dyma Cold-Rolled Steel, 1.2mm thick	Encapsulation:	Conformal Coating
Clamping Plate:	Cold-Rolled Steel, 1.6mm		
Warranty:	1 year		

Conforms to the latest revision ANSI/IEEE C62.41 (formerly IEEE587), ANSI/IEEE C62.45.

Project
Location/Type

TECHNICAL SPECIFICATIONS

Specification Grade Extra Heavy-Duty Surge Protective Receptacles

2 Pole, 3 Wire Grounding 15 & 20A, 125VAC

Typical Specifications

Manufacturer's Identification: Pass & Seymour® 5262ISP
 3rd Party Compliance: UL Listed, File Number E140596, Standard UL498, Attachment Plugs and Receptacles UL1449 Transient Voltage Surge Suppressor: Federal Specification WC596. CSA Certified, File Number LR16063, Standard CSA-C22.2 No. 42, ANSI/IEEE C62.41 (Formerly IEEE 587), ANSI/IEEE C62.45 Installation Categories "A" (Ring Wave) "B" (Unidirectional Impulse). Complies with NEC 410-56(c) and 250-74 exception 4. Conforms to NEMA WD-1 and WD-6.

CATALOG NUMBER	COLOR	RATING	NEMA CONFIG. NO.	CATALOG NUMBER	COLOR	RATING	NEMA CONFIG. NO.
☐ 5262ISP	Ivory	15A 125VAC	5-15R	☐ 5362ISP	Ivory	20A 125VAC	5-20R
☐ 5262WSP	White	15A 125VAC	5-15R	☐ 5362WSP	White	20A 125VAC	5-20R
☐ 5262SP	Brown	15A 125VAC	5-15R	☐ 5362SP	Brown	20A 125VAC	5-20R
☐ 5262BKSP	Black	15A 125VAC	5-15R	☐ 5362GRYSP	Gray	20A 125VAC	5-20R
☐ 5262REDSP	Red	15A 125VAC	5-15R	☐ 5362BKSP	Black	20A 125VAC	5-20R
☐ 5262LASP	Lt. Almond	15A 125VAC	5-15R	☐ 5362REDSP	Red	20A 125VAC	5-20R
☐ 5262BLSP	Blue	15A 125VAC	5-15R	☐ 5362LASP	Lt. Almond	20A 125VAC	5-20R
				☐ 5362BLSP	Blue	20A 125VAC	5-20R

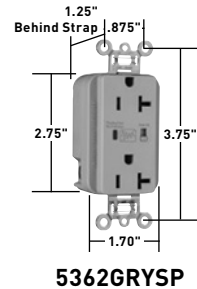

Performance

Electrical

Frequency:	60 Hz
Voltage:	125VAC
MOV Rating:	130V 17mm Dual Pack
Suppressed Voltage:	500V
Energy Rating:	340 Joules
Max Surge Capability:	24kA
Protection Modes:	Normal and Common Modes: Normal Mode (L-N) 500V Clamping; Common Mode (L-G) 500V Clamping, (N-G) 500V Clamping
Noise Attenuation:	Normal Mode (L-N) Capacitance Value = 0.0056 µF 7:1 Average Noise Reduction
Thermal Protection:	Three Thermal Fuses (128°C or 262°F)
Overcurrent Protection:	Three Fuses Protects 3 Modes
Operating Temperature:	-20°C to 55°C (-4 to 131°F)
Storage Temperature:	-40°C to 85°C (-40 to 185°F)

Mechanical

Terminal Identification:	Brass = Hot, Nickel = Neutral, Green = Ground
Terminal Accommodation:	#14 - 10 AWG copper conductor only
Product Identification:	Ratings are a permanent part of device
Weight:	125 grams

Environmental

Flammability:	UL94 V2
---------------	---------

Materials

Face:	Nylon	Terminal Screws:	Tri-Drive Brass #8 - 32
Body:	Nylon	Hex Head Grounding Screw:	Tri-Drive Steel (Green)
Line Terminal:	0lin #260 EH, 0.8mm thick	Auto-Ground Clip:	Stainless Steel
Grounding Terminal:	70/30 Brass, 0.4mm thick	Mounting Screws:	Tri-Drive Zinc-Plated Steel
(Uni-Ground Assembly)		LED:	Green/Red
Mounting Strap:	Super Dyma Cold-Rolled Steel, 1.2mm thick	Encapsulation:	Conformal Coating
Clamping Plate:	Cold-Rolled Steel, 1.6mm		
Warranty:	1 year		

Conforms to the latest revision ANSI/IEEE C62.41 (formerly IEEE587), ANSI/IEEE C62.45.

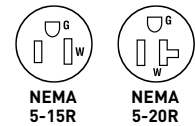

Features

- LED Indication:
 - Steady green = protected
 - Flashing red = not protected
 - OFF = no power to unit
- Alarm
- Alarm shutoff/override
- Brass 1-piece ground terminal assembly
- Back and side wire capability including ground terminal

Project
Location/Type

TECHNICAL SPECIFICATIONS

Specification Grade Isolated Ground Surge Protective Receptacles

2 Pole, 3 Wire Grounding 15 & 20A, 125VAC

Typical Specifications

Manufacturer's Identification: Pass & Seymour® IG5262ISP
 3rd Party Compliance: UL Listed, File Number E140596, Standard UL498, Attachment Plugs and Receptacles UL1449 Transient Voltage Surge Suppressor. Federal Specification WC596. CSA Certified, File Number LR16063, Standard CSA-C22.2 No. 42, ANSI/IEEE C62.41 (Formerly IEEE 587), ANSI/IEEE C62.45 Installation Categories "A" (Ring Wave) "B" (Unidirectional Impulse). Complies with NEC 410-56(c) and 250-74 exception 4. Conforms to NEMA WD-1 and WD-6.

CATALOG NUMBER	COLOR	RATING	NEMA CONFIG. NO.	CATALOG NUMBER	COLOR	RATING	NEMA CONFIG. NO.
<input type="checkbox"/> IG5262ISP	Ivory	15A 125VAC	5-15R	<input type="checkbox"/> IG5362ISP	Ivory	20A 125VAC	5-20R
<input type="checkbox"/> IG5262WSP	White	15A 125VAC	5-15R	<input type="checkbox"/> IG5362WSP	White	20A 125VAC	5-20R
<input type="checkbox"/> IG5262GRYSP	Gray	15A 125VAC	5-15R	<input type="checkbox"/> IG5362SP	Brown	20A 125VAC	5-20R
<input type="checkbox"/> IG5262BLSP	Blue	15A 125VAC	5-15R	<input type="checkbox"/> IG5362GRYSP	Gray	20A 125VAC	5-20R
<input type="checkbox"/> IG5262OSP	Orange	15A 125VAC	5-15R	<input type="checkbox"/> IG5362LASP	Lt. Almond	20A 125VAC	5-20R
				<input type="checkbox"/> IG5362BLSP	Blue	20A 125VAC	5-20R
				<input type="checkbox"/> IG5362OSP	Orange	20A 125VAC	5-20R

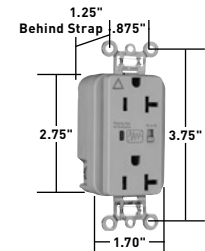

IG5362GRYSP

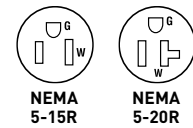

Performance

Electrical

Frequency:	60 Hz
Voltage:	125VAC
MOV Rating	130V 17mm Dual Pack
Suppressed Voltage:	500V
Energy Rating:	340 Joules
Max Surge Capability:	24kA
Protection Modes:	Normal and Common Modes: Normal Mode (L-N) 500V Clamping; Common Mode (L-G) 500V Clamping, (N-G) 500V Clamping
Noise Attenuation:	Normal Mode (L-N) Capacitance Value = 0.0056 µF 7:1 Average Noise Reduction
Thermal Protection:	Three Thermal Fuses (128°C or 262°F)
Overcurrent Protection:	Three Fuses Protects 3 Modes
Operating Temperature:	-20°C to 55°C (-4 to 131°F)
Storage Temperature:	-40°C to 85°C (-40 to 185°F)

Mechanical

Terminal Identification:	Brass = Hot, Nickel = Neutral, Green = Ground
Terminal Accommodation:	#14 - 10 AWG copper conductor only
Product Identification:	Ratings are a permanent part of device
Weight:	125 grams

Environmental

Flammability:	UL94 V2
---------------	---------

Materials

Face:	Nylon	Terminal Screws:	Tri-Drive Brass #8 - 32
Body:	Nylon	Hex Head Grounding Screw:	Tri-Drive Steel (Green)
Line Terminal:	Olin #260 EH, 0.8mm thick	Auto-Ground Clip:	Stainless Steel
Grounding Terminal:	70/30 Brass, 0.4mm thick	Mounting Screws:	Tri-Drive Zinc-Plated Steel
(Uni-Ground Assembly)		LED:	Green/Red
Mounting Strap:	Super Dyma Cold-Rolled Steel, 1.2mm thick	Encapsulation:	Conformal Coating
Clamping Plate:	Cold-Rolled Steel, 1.6mm		
Warranty:	1 year		

Conforms to the latest revision ANSI/IEEE C62.41 (formerly IEEE587), ANSI/IEEE C62.45.

Project
Location/Type

TECHNICAL SPECIFICATIONS

PlugTail® Extra Heavy-Duty Surge Protective Receptacles 2 Pole, 3 Wire Grounding, 15 & 20A, 125VAC

Typical Specifications

Manufacturer's Identification: Pass & Seymour® PT5262ISP
 3rd Party Compliance: UL Listed, File Number E140596, Standard UL498, Attachment Plugs and Receptacles UL1449 Transient Voltage Surge Suppressor. Federal Specification WC596. CSA Certified, File Number LR16063, Standard CSA-C22.2 No. 42, ANSI/IEEE C62.41 (Formerly IEEE 587), ANSI/IEEE C62.45 Installation Categories "A" (Ring Wave) "B" (Unidirectional Impulse). Complies with NEC 410-56(c) and 250-74 exception 4. Conforms to NEMA WD-1 and WD-6.

CATALOG NUMBER	COLOR	RATING	NEMA CONFIG. NO.	CATALOG NUMBER	COLOR	RATING	NEMA CONFIG. NO.
<input type="checkbox"/> PT5262ISP	Ivory	15A 125VAC	5-15R	<input type="checkbox"/> PT5362ISP	Ivory	20A 125VAC	5-20R
<input type="checkbox"/> PT5262WSP	White	15A 125VAC	5-15R	<input type="checkbox"/> PT5362WSP	White	20A 125VAC	5-20R
<input type="checkbox"/> PT5262GRYSP	Gray	15A 125VAC	5-15R	<input type="checkbox"/> PT5362SP	Brown	20A 125VAC	5-20R
<input type="checkbox"/> PT5262BKSP	Black	15A 125VAC	5-15R	<input type="checkbox"/> PT5362GRYSP	Gray	20A 125VAC	5-20R
<input type="checkbox"/> PT5262BLSP	Blue	15A 125VAC	5-15R	<input type="checkbox"/> PT5362BKSP	Black	20A 125VAC	5-20R
				<input type="checkbox"/> PT5362LASP	Lt. Almond	20A 125VAC	5-20R
				<input type="checkbox"/> PT5362BLSP	Blue	20A 125VAC	5-20R

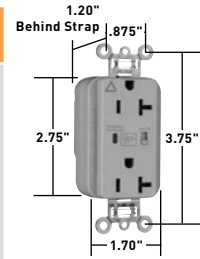

PTIG5362GRYSP

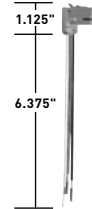

PTR6STR

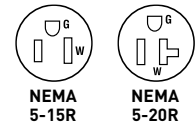

Features

- LED Indication:
 - Steady green = protected
 - Flashing red = not protected
 - OFF = no power to unit
- Alarm
 - Alarm shutoff/override
 - Brass 1-piece ground terminal assembly

Performance

Electrical

Frequency: 60 Hz
 Voltage: 125VAC
 MOV Rating: 130V 17mm Dual Pack
 Suppressed Voltage: 500V
 Energy Rating: 340 Joules (L-N) and (L-G) Modes; 680 Joules (N-G) Mode
 Max Surge Capability: 24kA
 Protection Modes: Normal and Common Modes: Normal Mode (L-N) 500V Clamping; Common Mode (L-G) 500V Clamping, (N-G) 1000V Clamping
 Noise Attenuation: Normal Mode (L-N)
 Capacitance Value = 0.0056 µF
 7:1 Average Noise Reduction
 Thermal Protection: Two Thermal Fuses (128°C or 262°F)
 Overcurrent Protection: Two Fuses Protects 3 Modes
 Operating Temperature: -20°C to 55°C (-4 to 131°F)
 Storage Temperature: -40°C to 85°C (-40 to 185°F)

Mechanical

PlugTail Connector Identification: #12 AWG, THHN, copper conductor, 6" leads, stripped, solid or stranded, for use with Plugtail Receptacles only
 Ratings are a permanent part of device
 Product Identification:
 Weight: 125 grams

Environmental

Flammability: UL94 V2

Materials

Face:	Nylon	Auto-Ground Clip:	Stainless Steel
Body:	Nylon	Mounting Screws:	Tri-Drive Zinc-Plated Steel
Line Terminal:	Olin #260 EH, 0.8mm thick	LED:	Green/Red
Grounding Terminal:	70/30 Brass, 0.4mm thick	Encapsulation:	Conformal Coating
(Uni-Ground Assembly)		PlugTail Connector	
Mounting Strap:	Super Dyma Cold-Rolled Steel, 1.2mm thick	Housing:	Polycarbonate
Warranty:	1 year	Contacts:	.030" Brass

Conforms to the latest revision ANSI/IEEE C62.41 (formerly IEEE587), ANSI/IEEE C62.45.

Project
Location/Type

TECHNICAL SPECIFICATIONS

PlugTail® Isolated Ground Surge Protective Receptacles

2 Pole, 3 Wire Grounding 15 & 20A, 125VAC

Typical Specifications

Manufacturer's Identification: Pass & Seymour® PTIG5262ISP
 3rd Party Compliance: UL Listed, File Number E140596, Standard UL498, Attachment Plugs and Receptacles UL1449 Transient Voltage Surge Suppressor. Federal Specification WC596. CSA Certified, File Number LR16063, Standard CSA-C22.2 No. 42, ANSI/IEEE C62.41 (Formerly IEEE 587), ANSI/IEEE C62.45 Installation Categories "A" (Ring Wave) "B" (Unidirectional Impulse). Complies with NEC 410-56(c) and 250-74 exception 4. Conforms to NEMA WD-1 and WD-6.

CATALOG NUMBER	COLOR	RATING	NEMA CONFIG. NO.	CATALOG NUMBER	COLOR	RATING	NEMA CONFIG. NO.
<input type="checkbox"/> PTIG5262WSP	White	15A 125VAC	5-15R	<input type="checkbox"/> PTIG5362ISP	Ivory	20A 125VAC	5-20R
<input type="checkbox"/> PTIG5262OSP	Orange	15A 125VAC	5-15R	<input type="checkbox"/> PTIG5362WSP	White	20A 125VAC	5-20R
				<input type="checkbox"/> PTIG5362GRYSP	Gray	20A 125VAC	5-20R
				<input type="checkbox"/> PTIG5362BKSP	Black	20A 125VAC	5-20R
				<input type="checkbox"/> PTIG5362LASP	Lt. Almond	20A 125VAC	5-20R
				<input type="checkbox"/> PTIG5362OSP	Orange	20A 125VAC	5-20R

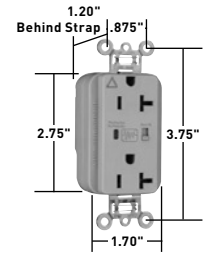

PTIG5362GRYSP

Features

- LED Indication:
 - Steady green = protected
 - Flashing red = not protected
 - OFF = no power to unit
- Alarm
- Alarm shutoff/override
- Brass 1-piece ground terminal assembly

Performance

Electrical

Frequency: 60 Hz
 Voltage: 125VAC
 MOV Rating: 130V 17mm Dual Pack
 Suppressed Voltage: 500V
 Energy Rating: 340 Joules (L-N) and (L-G) Modes; 680 Joules (N-G) Mode
 Max Surge Capability: 24kA
 Protection Modes: Normal and Common Modes: Normal Mode (L-N) 500V Clamping; Common Mode (L-G) 500V Clamping, (N-G) 1000V Clamping
 Noise Attenuation: Normal Mode (L-N)
 Capacitance Value = 0.0056 µF
 7:1 Average Noise Reduction

Thermal Protection: Two Thermal Fuses (128°C or 262°F)
 Overcurrent Protection: Two Fuses Protects 3 Modes
 Operating Temperature: -20°C to 55°C (-4 to 131°F)
 Storage Temperature: -40°C to 85°C (-40 to 185°F)

Mechanical

PlugTail Connector Identification: #12 AWG, THHN, copper conductor, 6" leads, stripped, solid or stranded, for use with Plugtail Receptacles only
 Product Identification: Ratings are a permanent part of device
 Weight: 125 grams

Environmental

Flammability: UL94 V2

Materials

Face:	Nylon	Auto-Ground Clip:	Stainless Steel
Body:	Nylon	Mounting Screws:	Tri-Drive Zinc-Plated Steel
Line Terminal:	Olin #260 EH, 0.8mm thick	LED:	Green/Red
Grounding Terminal:	70/30 Brass, 0.4mm thick	Encapsulation:	Conformal Coating
(Uni-Ground Assembly)		PlugTail Connector	
Mounting Strap:	Super Dyma Cold-Rolled Steel, 1.2mm thick	Housing:	Polycarbonate
Warranty:	1 year	Contacts:	.030" Brass

Conforms to the latest revision ANSI/IEEE C62.41 (formerly IEEE587), ANSI/IEEE C62.45.



PTR46STR

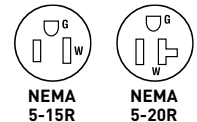

NEMA 5-15R

NEMA 5-20R

Project
Location/Type

TECHNICAL SPECIFICATIONS

PlugTail® Hospital Grade Extra Heavy-Duty Surge Protective Receptacles

2 Pole, 3 Wire Grounding, 15 & 20A, 125VAC

Typical Specifications

Manufacturer's Identification: Pass & Seymour® PTTR5262WSP
 3rd Party Compliance: UL Listed, File Number E140596, Standard UL498, Attachment Plugs and Receptacles UL1449 Transient Voltage Surge Suppressor. Federal Specification WC596. CSA Certified, File Number LR16063, Standard CSA-C22.2 No. 42, ANSI/IEEE C62.41 (Formerly IEEE 587), ANSI/IEEE C62.45 Installation Categories "A" (Ring Wave) "B" (Unidirectional Impulse). Complies with NEC 410-56(c) and 250-74 exception 4. Conforms to NEMA WD-1 and WD-6.

CATALOG NUMBER	COLOR	RATING	NEMA CONFIG. NO.	CATALOG NUMBER	COLOR	RATING	NEMA CONFIG. NO.
□ PTTR5262WSP	White	15A 125VAC	5-15R	□ PTTR5362ISP	Ivory	20A 125VAC	5-20R
□ PTTR5262SP	Brown	15A 125VAC	5-15R	□ PTTR5362WSP	White	20A 125VAC	5-20R
				□ PTTR5362GRYSP	Gray	20A 125VAC	5-20R
				□ PTTR5362LASP	Lt. Almond	20A 125VAC	5-20R
				□ PTTR5362BLSP	Blue	20A 125VAC	5-20R

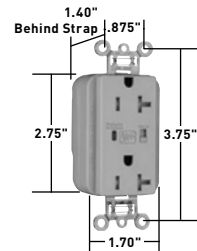

PTTR5362GRYSP



PTR6STR

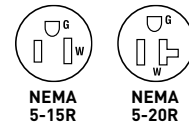

Features

- LED Indication:
 - Steady green = protected
 - Flashing red = not protected
 - OFF = no power to unit
- Alarm
- Alarm shutoff/override
- Brass 1-piece ground terminal assembly

Performance

Electrical

- Frequency: 60 Hz
- Voltage: 125VAC
- MOV Rating: 130V 17mm Dual Pack
- Suppressed Voltage: 500V
- Energy Rating: 340 Joules (L-N) and (L-G) Modes; 680 Joules (N-G) Mode
- Max Surge Capability: 24kA
- Protection Modes: Normal and Common Modes: Normal Mode (L-N) 500V Clamping; Common Mode (L-G) 500V Clamping, (N-G) 1000V Clamping
- Noise Attenuation: Normal Mode (L-N)
 - Capacitance Value = 0.0056 µF
 - 7:1 Average Noise Reduction
- Thermal Protection: Two Thermal Fuses (128°C or 262°F)
- Overcurrent Protection: Two Fuses Protects 3 Modes
- Operating Temperature: -20°C to 55°C (-4 to 131°F)
- Storage Temperature: -40°C to 85°C (-40 to 185°F)

Mechanical

- PlugTail Connector Identification: #12 AWG, THHN, copper conductor, 6" leads, stripped, solid or stranded, for use with Plugtail Receptacles only
- Product Identification: Ratings are a permanent part of device
- Weight: 125 grams

Environmental

- Flammability: UL94 V2

Materials

- Face: Nylon
- Body: Nylon
- Line Terminal: Olin #260 EH, 0.8mm thick
- Grounding Terminal: 70/30 Brass, 0.4mm thick (Uni-Ground Assembly)
- Mounting Strap: Super Dyma Cold-Rolled Steel, 1.2mm thick
- Warranty: 1 year
- Auto-Ground Clip: Stainless Steel
- Mounting Screws: Tri-Drive Zinc-Plated Steel
- LED: Green/Red
- Encapsulation: Conformal Coating
- PlugTail Connector
- Housing: Polycarbonate
- Contacts: .030" Brass

Conforms to the latest revision ANSI/IEEE C62.41 (formerly IEEE587), ANSI/IEEE C62.45.

TECHNICAL SPECIFICATIONS

Project
Location/Type

TECHNICAL SPECIFICATIONS

PlugTail® Hospital Grade Extra Heavy-Duty Surge Protective Receptacles

2 Pole, 3 Wire Grounding, 15 & 20A, 125VAC

Typical Specifications

Manufacturer's Identification: Pass & Seymour® PT8200ISP
 3rd Party Compliance: UL Listed, File Number E140596, Standard UL498, Attachment Plugs and Receptacles UL1449 Transient Voltage Surge Suppressor. Federal Specification WC596. CSA Certified, File Number LR16063, Standard CSA-C22.2 No. 42, ANSI/IEEE C62.41 (Formerly IEEE 587), ANSI/IEEE C62.45 Installation Categories "A" (Ring Wave) "B" (Unidirectional Impulse). Complies with NEC 410-56(c) and 250-74 exception 4. Conforms to NEMA WD-1 and WD-6.

CATALOG NUMBER	COLOR	RATING	NEMA CONFIG. NO.	CATALOG NUMBER	COLOR	RATING	NEMA CONFIG. NO.
<input type="checkbox"/> PT8200ISP	Ivory	15A 125VAC	5-15R	<input type="checkbox"/> PT8300ISP	Ivory	20A 125VAC	5-20R
<input type="checkbox"/> PT8200WSP	White	15A 125VAC	5-15R	<input type="checkbox"/> PT8300WSP	White	20A 125VAC	5-20R
<input type="checkbox"/> PT8200SP	Brown	15A 125VAC	5-15R	<input type="checkbox"/> PT8300SP	Brown	20A 125VAC	5-20R
<input type="checkbox"/> PT8200BLSP	Blue	15A 125VAC	5-15R	<input type="checkbox"/> PT8300GRYSP	Gray	20A 125VAC	5-20R
				<input type="checkbox"/> PT8300REDSP	Red	20A 125VAC	5-20R

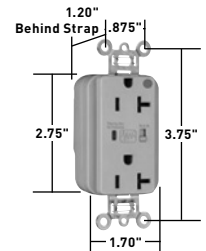

PT8300GRYSP



PTR6STR

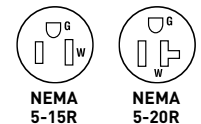

Features

- LED Indication:
 - Steady green = protected
 - Flashing red = not protected
 - OFF = no power to unit
- Alarm
- Alarm shutoff/override
- Brass 1-piece ground terminal assembly

Performance

Electrical

Frequency: 60 Hz
 Voltage: 125VAC
 MOV Rating: 130V 17mm Dual Pack
 Suppressed Voltage: 500V
 Energy Rating: 340 Joules (L-N) and (L-G) Modes; 680 Joules (N-G) Mode
 Max Surge Capability: 24kA
 Protection Modes: Normal and Common Modes: Normal Mode (L-N) 500V Clamping; Common Mode (L-G) 500V Clamping, (N-G) 1000V Clamping
 Noise Attenuation: Normal Mode (L-N)
 Capacitance Value = 0.0056 µF
 7:1 Average Noise Reduction
 Thermal Protection: Two Thermal Fuses (128°C or 262°F)
 Overcurrent Protection: Two Fuses Protects 3 Modes
 Operating Temperature: -20°C to 55°C (-4 to 131°F)
 Storage Temperature: -40°C to 85°C (-40 to 185°F)

Mechanical

PlugTail Connector Identification: #12 AWG, THHN, copper conductor, 6" leads, stripped, solid or stranded, for use with Plugtail Receptacles only
 Product Identification: Ratings are a permanent part of device
 Weight: 125 grams

Environmental

Flammability: UL94 V2

Materials

Face:	Nylon	Auto-Ground Clip:	Stainless Steel
Body:	Nylon	Mounting Screws:	Tri-Drive Zinc-Plated Steel
Line Terminal:	Olin #260 EH, 0.8mm thick	LED:	Green/Red
Grounding Terminal:	70/30 Brass, 0.4mm thick	Encapsulation:	Conformal Coating
(Uni-Ground Assembly)		PlugTail Connector	
Mounting Strap:	Super Dyma Cold-Rolled Steel, 1.2mm thick	Housing:	Polycarbonate
Warranty:	1 year	Contacts:	.030" Brass

Conforms to the latest revision ANSI/IEEE C62.41 (formerly IEEE587), ANSI/IEEE C62.45.

Project
Location/Type

TECHNICAL SPECIFICATIONS

PlugTail® Hospital Grade Isolated Ground Surge Protective Receptacles

2 Pole, 3 Wire Grounding, 15 & 20A, 125VAC

Typical Specifications

Manufacturer's Identification: Pass & Seymour® PTIG8200ISP
 3rd Party Compliance: UL Listed, File Number E140596, Standard UL498, Attachment Plugs and Receptacles UL1449
 Transient Voltage Surge Suppressor. Federal Specification WC596. CSA Certified, File Number LR16063, Standard
 CSA-C22.2 No. 42, ANSI/IEEE C62.41 (Formerly IEEE 587), ANSI/IEEE C62.45 Installation Categories "A" (Ring Wave) "B"
 (Unidirectional Impulse). Complies with NEC 410-56(c) and 250-74 exception 4. Conforms to NEMA WD-1 and WD-6.

CATALOG NUMBER	COLOR	RATING	NEMA CONFIG. NO.	CATALOG NUMBER	COLOR	RATING	NEMA CONFIG. NO.
<input type="checkbox"/> PTIG8200REDSP	Red	15A 125VAC	5-15R	<input type="checkbox"/> PTIG8300SP	Brown	20A 125VAC	5-20R
<input type="checkbox"/> PTIG8200LASP	Lt. Almond	15A 125VAC	5-15R	<input type="checkbox"/> PTIG8300REDSP	Red	20A 125VAC	5-20R
<input type="checkbox"/> PTIG8200OSP	Orange	15A 125VAC	5-15R	<input type="checkbox"/> PTIG8300BLSP	Blue	20A 125VAC	5-20R
				<input type="checkbox"/> PTIG8300OSP	Orange	20A 125VAC	5-20R

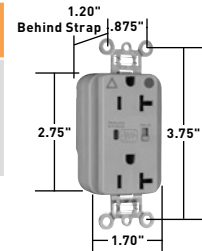

PTIG8300SP

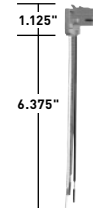

PTR6STR

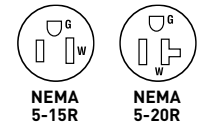

Features

- LED Indication:
 - Steady green = protected
 - Flashing red = not protected
 - OFF = no power to unit
- Alarm
- Alarm shutoff/override
- Brass 1-piece ground terminal assembly

Performance

Electrical

Frequency: 60 Hz
 Voltage: 125VAC
 MOV Rating: 130V 17mm Dual Pack
 Suppressed Voltage: 500V
 Energy Rating: 340 Joules (L-N) and (L-G) Modes; 680 Joules (N-G) Mode
 Max Surge Capability: 24kA
 Protection Modes: Normal and Common Modes: Normal Mode (L-N) 500V Clamping; Common Mode (L-G) 500V Clamping, (N-G) 1000V Clamping

Noise Attenuation: Normal Mode (L-N)
 Capacitance Value = 0.0056 µF
 7:1 Average Noise Reduction

Thermal Protection: Two Thermal Fuses (128°C or 262°F)
 Overcurrent Protection: Two Fuses Protects 3 Modes
 Operating Temperature: -20°C to 55°C (-4 to 131°F)
 Storage Temperature: -40°C to 85°C (-40 to 185°F)

Mechanical

PlugTail Connector Identification: #12 AWG, THHN, copper conductor, 6" leads, stripped, solid or stranded, for use with Plugtail Receptacles only
 Product Identification: Ratings are a permanent part of device
 Weight: 125 grams

Environmental

Flammability: UL94 V2

Materials

Face:	Nylon	Auto-Ground Clip:	Stainless Steel
Body:	Nylon	Mounting Screws:	Tri-Drive Zinc-Plated Steel
Line Terminal:	Olin #260 EH, 0.8mm thick	LED:	Green/Red
Grounding Terminal:	70/30 Brass, 0.4mm thick	Encapsulation:	Conformal Coating
(Uni-Ground Assembly)		PlugTail Connector	
Mounting Strap:	Super Dyma Cold-Rolled Steel, 1.2mm thick	Housing:	Polycarbonate
Warranty:	1 year	Contacts:	.030" Brass

Conforms to the latest revision ANSI/IEEE C62.41 (formerly IEEE587), ANSI/IEEE C62.45.

Project
Location/Type

TECHNICAL SPECIFICATIONS

PlugTail® Hospital Grade Tamper-Resistant Surge Protective Receptacles

2 Pole, 3 Wire Grounding, 15 & 20A, 125VAC

Typical Specifications

Manufacturer's Identification: Pass & Seymour® PTTR8200ISP
 3rd Party Compliance: UL Listed, File Number E140596, Standard UL498, Attachment Plugs and Receptacles UL1449
 Transient Voltage Surge Suppressor. Federal Specification WC596. CSA Certified, File Number LR16063, Standard
 CSA-C22.2 No. 42, ANSI/IEEE C62.41 (Formerly IEEE 587), ANSI/IEEE C62.45 Installation Categories "A" (Ring Wave)
 "B" (Unidirectional Impulse). Complies with NEC 410-56(c) and 250-74 exception 4. Conforms to NEMA WD-1 and WD-6.

CATALOG NUMBER	COLOR	RATING	NEMA CONFIG. NO.	CATALOG NUMBER	COLOR	RATING	NEMA CONFIG. NO.
<input type="checkbox"/> PTTR8200WSP	White	15A 125VAC	5-15R	<input type="checkbox"/> PTTR8300ISP	Ivory	20A 125VAC	5-20R
<input type="checkbox"/> PTTR8200REDSP	Red	15A 125VAC	5-15R	<input type="checkbox"/> PTTR8300WSP	White	20A 125VAC	5-20R
<input type="checkbox"/> PTTR8200BLSP	Blue	15A 125VAC	5-15R	<input type="checkbox"/> PTTR8300GRYSP	Gray	20A 125VAC	5-20R
				<input type="checkbox"/> PTTR8300REDSP	Red	20A 125VAC	5-20R
				<input type="checkbox"/> PTTR8300BLSP	Blue	20A 125VAC	5-20R

Features

- LED Indication:
 - Steady green = protected
 - Flashing red = not protected
 - OFF = no power to unit
- Alarm
 - Alarm shutoff/override
 - Brass 1-piece ground terminal assembly
 - Back and side wire capability including ground terminal

Performance

Electrical

Frequency: 60 Hz
 Voltage: 125VAC
 MOV Rating: 130V 17mm Dual Pack
 Suppressed Voltage: 500V
 Energy Rating: 340 Joules (L-N) and (L-G) Modes; 680 Joules (N-G) Mode
 Max Surge Capability: 24kA
 Protection Modes: Normal and Common Modes: Normal Mode (L-N) 500V Clamping; Common Mode (L-G) 500V Clamping, (N-G) 1000V Clamping
 Noise Attenuation: Normal Mode (L-N)
 Capacitance Value = 0.0056 µF
 7:1 Average Noise Reduction
 Thermal Protection: Two Thermal Fuses (128°C or 262°F)
 Overcurrent Protection: Two Fuses Protects 3 Modes
 Operating Temperature: -20°C to 55°C (-4 to 131°F)
 Storage Temperature: -40°C to 85°C (-40 to 185°F)

Mechanical

PlugTail Connector Identification: #12 AWG, THHN, copper conductor, 6" leads, stripped, solid or stranded, for use with Plugtail Receptacles only
 Product Identification: Ratings are a permanent part of device
 Weight: 125 grams

Environmental

Flammability: UL94 V2

Materials

Face:	Nylon	Auto-Ground Clip:	Stainless Steel
Body:	Nylon	Mounting Screws:	Tri-Drive Zinc-Plated Steel
Line Terminal:	Olin #260 EH, 0.8mm thick	LED:	Green/Red
Grounding Terminal:	70/30 Brass, 0.4mm thick	Encapsulation:	Conformal Coating
(Uni-Ground Assembly)		PlugTail Connector	
Mounting Strap:	Super Dyma Cold-Rolled Steel, 1.2mm thick	Housing:	Polycarbonate
Warranty:	1 year	Contacts:	.030" Brass

Conforms to the latest revision ANSI/IEEE C62.41 (formerly IEEE587), ANSI/IEEE C62.45.

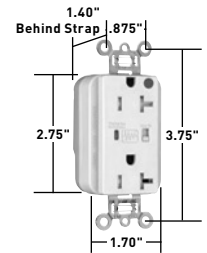

PTTR8300ISP

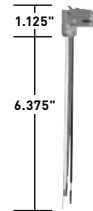

PTR46STR

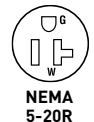
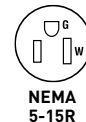

Project
Location/Type

TECHNICAL SPECIFICATIONS

Extra Heavy-Duty Tamper-Resistant Surge Protective Receptacles

2 Pole, 3 Wire Grounding, 15 & 20A, 125VAC

Typical Specifications

Manufacturer's Identification: Pass & Seymour® TR5262ISP
 3rd Party Compliance: UL Listed, File Number E140596, Standard UL498, Attachment Plugs and Receptacles UL1449
 Transient Voltage Surge Suppressor. Federal Specification WC596. CSA Certified, File Number LR16063, Standard
 CSA-C22.2 No. 42, ANSI/IEEE C62.41 (Formerly IEEE 587), ANSI/IEEE C62.45 Installation Categories "A" (Ring Wave)
 "B" (Unidirectional Impulse). Complies with NEC 410-56(c) and 250-74 exception 4. Conforms to NEMA WD-1 and WD-6.

CATALOG NUMBER	COLOR	RATING	NEMA CONFIG. NO.	CATALOG NUMBER	COLOR	RATING	NEMA CONFIG. NO.
<input type="checkbox"/> TR5262ISP	Ivory	15A 125VAC	5-15R	<input type="checkbox"/> TR5362ISP	Ivory	20A 125VAC	5-20R
<input type="checkbox"/> TR5262WSP	White	15A 125VAC	5-15R	<input type="checkbox"/> TR5362WSP	White	20A 125VAC	5-20R
<input type="checkbox"/> TR5262SP	Brown	15A 125VAC	5-15R	<input type="checkbox"/> TR5362SP	Brown	20A 125VAC	5-20R
<input type="checkbox"/> TR5262GRYSP	Gray	15A 125VAC	5-15R	<input type="checkbox"/> TR5362GRYSP	Gray	20A 125VAC	5-20R
<input type="checkbox"/> TR5262LASP	Lt. Almond	15A 125VAC	5-15R	<input type="checkbox"/> TR5362BKSP	Black	20A 125VAC	5-20R
<input type="checkbox"/> TR5262BLSP	Blue	15A 125VAC	5-15R	<input type="checkbox"/> TR5362LASP	Lt. Almond	20A 125VAC	5-20R
				<input type="checkbox"/> TR5362BLSP	Blue	20A 125VAC	5-20R

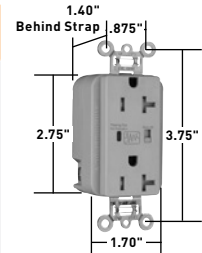

TR5362GRYSP

Features

- LED Indication:
 - Steady green = protected
 - Flashing red = not protected
 - OFF = no power to unit
- Alarm
- Alarm shutoff/override
- Brass 1-piece ground terminal assembly
- Back and side wire capability including ground terminal

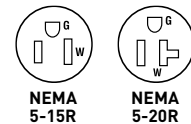

Performance

Electrical

Frequency: 60 Hz
 Voltage: 125VAC
 MOV Rating: 130V 17mm Dual Pack
 Suppressed Voltage: 500V
 Energy Rating: 340 Joules
 Max Surge Capability: 24kA
 Protection Modes: Normal and Common Modes: Normal Mode (L-N) 500V Clamping;
 Common Mode (L-G) 500V Clamping, (N-G) 500V Clamping
 Noise Attenuation: Normal Mode (L-N)
 Capacitance Value = 0.0056 µF
 7:1 Average Noise Reduction
 Thermal Protection: Three Thermal Fuses (128°C or 262°F)
 Overcurrent Protection: Three Fuses Protects 3 Modes
 Operating Temperature: -20°C to 55°C (-4 to 131°F)
 Storage Temperature: -40°C to 85°C (-40 to 185°F)

Mechanical

Terminal Identification: Brass = Hot, Nickel = Neutral, Green = Ground
 Terminal Accommodation: #14 - 10 AWG copper conductor only
 Product Identification: Ratings are a permanent part of device
 Weight: 125 grams

Environmental

Flammability: UL94 V2

Materials

Face:	Nylon	Terminal Screws:	Tri-Drive Brass #8 - 32
Body:	Nylon	Hex Head	
Line Terminal:	Olin #260 EH, 0.8mm thick	Grounding Screw:	Tri-Drive Steel (Green)
Grounding Terminal:	70/30 Brass, 0.4mm thick	Auto-Ground Clip:	Stainless Steel
(Uni-Ground Assembly)		Mounting Screws:	Tri-Drive Zinc-Plated Steel
Mounting Strap:	Super Dyma Cold-Rolled Steel, 1.2mm thick	LED:	Green/Red
Clamping Plate:	Cold-Rolled Steel, 1.6mm	Encapsulation:	Conformal Coating
Warranty:	1 year	Tamper Shutter:	Thermoplastic

Conforms to the latest revision ANSI/IEEE C62.41 (formerly IEEE587), ANSI/IEEE C62.45.

TECHNICAL SPECIFICATIONS

Project
Location/Type

TECHNICAL SPECIFICATIONS

Tamper-Resistant Isolated Ground Surge Protective Receptacles

2 Pole, 3 Wire Grounding 15 & 20A, 125VAC

Typical Specifications

Manufacturer's Identification: Pass & Seymour® TRIG5262ISP

3rd Party Compliance: UL Listed, File Number E140596, Standard UL498, Attachment Plugs and Receptacles UL1449

Transient Voltage Surge Suppressor. Federal Specification WC596. CSA Certified, File Number LR16063, Standard CSA-C22.2 No. 42, ANSI/IEEE C62.41 (Formerly IEEE 587), ANSI/IEEE C62.45 Installation Categories "A" (Ring Wave) "B" (Unidirectional Impulse). Complies with NEC 410-56(c) and 250-74 exception 4. Conforms to NEMA WD-1 and WD-6.

CATALOG NUMBER	COLOR	RATING	NEMA CONFIG. NO.	CATALOG NUMBER	COLOR	RATING	NEMA CONFIG. NO.
<input type="checkbox"/> TRIG5262WSP	White	15A 125VAC	5-15R	<input type="checkbox"/> TRIG5362WSP	White	20A 125VAC	5-20R
<input type="checkbox"/> TRIG5262BLSP	Blue	15A 125VAC	5-15R	<input type="checkbox"/> TRIG5362LASP	Lt. Almond	20A 125VAC	5-20R
<input type="checkbox"/> TRIG5262OSP	Orange	15A 125VAC	5-15R	<input type="checkbox"/> TRIG5362OSP	Orange	20A 125VAC	5-20R

Features

- LED Indication:
 - Steady green = protected
 - Flashing red = not protected
 - OFF = no power to unit
- Alarm
- Alarm shutoff/override
- Brass 1-piece ground terminal assembly
- Back and side wire capability including ground terminal

Performance

Electrical

Frequency:	60 Hz
Voltage:	125VAC
MOV Rating:	130V 17mm Dual Pack
Suppressed Voltage	500V
Energy Rating:	340 Joules
Max Surge Capability:	24kA
Protection Modes	Normal and Common Modes: Normal Mode (L-N) 500V Clamping; Common Mode (L-G) 500V Clamping, (N-G) 500V Clamping
Noise Attenuation:	Normal Mode (L-N) Capacitance Value = 0.0056 µF 7:1 Average Noise Reduction
Thermal Protection:	Three Thermal Fuses (128°C or 262°F)
Overcurrent Protection:	Three Fuses Protects 3 Modes
Operating Temperature:	-20°C to 55°C (-4 to 131°F)
Storage Temperature:	-40°C to 85°C (-40 to 185°F)

Mechanical

Terminal Identification:	Brass = Hot, Nickel = Neutral, Green = Ground
Terminal Accommodation:	#14 - 10 AWG copper conductor only
Product Identification:	Ratings are a permanent part of device
Weight:	125 grams

Environmental

Flammability:	UL94 V2
---------------	---------

Materials

Face:	Nylon	Terminal Screws:	Tri-Drive Brass #8 - 32
Body:	Nylon	Hex Head Grounding:	Tri-Drive Steel (Green) Screw
Line Terminal:	Olin #260 EH, 0.8mm thick	Auto-Ground Clip:	Stainless Steel
Grounding Terminal:	70/30 Brass, 0.4mm thick	Mounting Screws:	Tri-Drive Zinc-Plated Steel
(Uni-Ground Assembly)		LED:	Green/Red
Mounting Strap:	Super Dyma Cold-Rolled Steel, 1.2mm thick	Encapsulation:	Conformal Coating
Clamping Plate:	Cold-Rolled Steel, 1.6mm	Tamper Shutter:	Thermoplastic
Warranty:	1 year		

Conforms to the latest revision ANSI/IEEE C62.41 (formerly IEEE587), ANSI/IEEE C62.45.

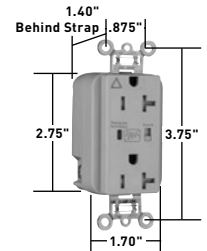

TRIG5362OSP

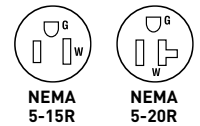

Project
Location/Type

TECHNICAL SPECIFICATIONS

Extra Heavy-Duty Tamper-Resistant Hospital Grade Surge Protective Receptacles

2 Pole, 3 Wire Grounding, 15 & 20A, 125VAC

Typical Specifications

Manufacturer's Identification: Pass & Seymour® TR8200ISP
 3rd Party Compliance: UL Listed, File Number E140596, Standard UL498, Attachment Plugs and Receptacles UL1449 Transient Voltage Surge Suppressor. Federal Specification WC596. CSA Certified, File Number LR16063, Standard CSA-C22.2 No. 42, ANSI/IEEE C62.41 (Formerly IEEE 587), ANSI/IEEE C62.45 Installation Categories "A" (Ring Wave) "B" (Unidirectional Impulse). Complies with NEC 410-56(c) and 250-74 exception 4. Conforms to NEMA WD-1 and WD-6.

CATALOG NUMBER	COLOR	RATING	NEMA CONFIG. NO.	CATALOG NUMBER	COLOR	RATING	NEMA CONFIG. NO.
<input type="checkbox"/> TR8200WSP	White	15A 125VAC	5-15R	<input type="checkbox"/> TR8300ISP	Ivory	20A 125VAC	5-20R
<input type="checkbox"/> TR8200SP	Brown	15A 125VAC	5-15R	<input type="checkbox"/> TR8300WSP	White	20A 125VAC	5-20R
<input type="checkbox"/> TR8200REDSP	Red	15A 125VAC	5-15R	<input type="checkbox"/> TR8300REDSP	Red	20A 125VAC	5-20R
<input type="checkbox"/> TR8200LASP	Lt. Almond	15A 125VAC	5-15R	<input type="checkbox"/> TR8300BLSP	Blue	20A 125VAC	5-20R

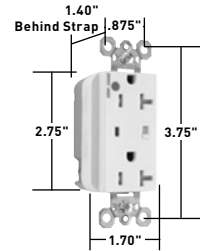

TR8300WSP

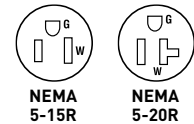

Features

- LED Indication:
 - Steady green = protected
 - Flashing red = not protected
 - OFF = no power to unit
- Alarm
- Alarm shutoff/override
- Brass 1-piece ground terminal assembly
- Back and side wire capability including ground terminal

Performance

Electrical

Frequency: 60 Hz
 Voltage: 125VAC
 MOV Rating: 130V 17mm Dual Pack
 Suppressed Voltage: 500V
 Energy Rating: 340 Joules
 Max Surge Capability: 24kA
 Protection Modes: Normal and Common Modes:
 Normal Mode (L-N) 500V Clamping; Common Mode (L-G) 500V Clamping, (N-G) 500V Clamping
 Noise Attenuation: Normal Mode (L-N)
 Capacitance Value = 0.0056 µF
 7:1 Average Noise Reduction
 Thermal Protection: Three Thermal Fuses (128°C or 262°F)
 Overcurrent Protection: Three Fuses Protects 3 Modes
 Operating Temperature: -20°C to 55°C (-4 to 131°F)
 Storage Temperature: -40°C to 85°C (-40 to 185°F)

Mechanical

Terminal Identification: Brass = Hot, Nickel = Neutral, Green = Ground
 Terminal Accommodation: #14 – 10 AWG copper conductor only
 Product Identification: Ratings are a permanent part of device
 Weight: 125 grams

Environmental

Flammability: UL94 V2

Materials

Face: Nylon
 Body: Nylon
 Line Terminal: Olin #260 EH, 0.8mm thick
 Grounding Terminal: 70/30 Brass, 0.4mm thick (Uni-Ground Assembly)
 Mounting Strap: Super Dyma Cold-Rolled Steel, 1.2mm thick
 Clamping Plate: Cold-Rolled Steel, 1.6mm
Warranty: 1 year

Terminal Screws: Tri-Drive Brass #8 - 32 Hex Head
 Grounding Screw: Tri-Drive Steel (Green)
 Auto-Ground Clip: Stainless Steel
 Mounting Screws: Tri-Drive Zinc-Plated Steel
 LED: Green/Red
 Encapsulation: Conformal Coating
 Tamper Shutter: Thermoplastic

Conforms to the latest revision ANSI/IEEE C62.41 (formerly IEEE587), ANSI/IEEE C62.45.

TECHNICAL SPECIFICATIONS

Project
Location/Type

TECHNICAL SPECIFICATIONS

Tamper-Resistant Hospital Grade Isolated Ground Surge Protective Receptacles

2 Pole, 3 Wire Grounding 15 & 20A, 125VAC

Typical Specifications

Manufacturer's Identification: Pass & Seymour® TRIG8200ISP
 3rd Party Compliance: UL Listed, File Number E140596, Standard UL498, Attachment Plugs and Receptacles UL1449 Transient Voltage Surge Suppressor. Federal Specification WC596. CSA Certified, File Number LR16063, Standard CSA-C22.2 No. 42, ANSI/IEEE C62.41 (Formerly IEEE 587), ANSI/IEEE C62.45 Installation Categories "A" (Ring Wave) "B" (Unidirectional Impulse). Complies with NEC 410-56(c) and 250-74 exception 4. Conforms to NEMA WD-1 and WD-6.

CATALOG NUMBER	COLOR	RATING	NEMA CONFIG. NO.	CATALOG NUMBER	COLOR	RATING	NEMA CONFIG. NO.
☐ TRIG8200WSP	White	15A 125VAC	5-15R	☐ TRIG8300ISP	Ivory	20A 125VAC	5-20R
☐ TRIG8200REDSP	Red	15A 125VAC	5-15R	☐ TRIG8300WSP	White	20A 125VAC	5-20R
☐ TRIG8200BLSP	Blue	15A 125VAC	5-15R	☐ TRIG8300REDSP	Red	20A 125VAC	5-20R
				☐ TRIG8300BLSP	Blue	20A 125VAC	5-20R
				☐ TRIG8300OSP	Orange	20A 125VAC	5-20R

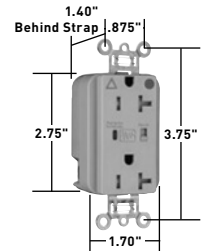

TRIG8300OSP

Features

- LED Indication:
 - Steady green = protected
 - Flashing red = not protected
 - OFF = no power to unit
- Alarm
- Alarm shutoff/override
- Brass 1-piece ground terminal assembly
- Back and side wire capability including ground terminal

Performance

Electrical

Frequency: 60 Hz
 Voltage: 125VAC
 MOV Rating: 130V 17mm Dual Pack
 Suppressed Voltage: 500V
 Energy Rating: 340 Joules
 Max Surge Capability: 24kA
 Protection Modes: Normal and Common Modes: Normal Mode (L-N) 500V Clamping; Common Mode (L-G) 500V Clamping, (N-G) 500V Clamping
 Noise Attenuation: Normal Mode (L-N)
 Capacitance Value = 0.0056 µF
 7:1 Average Noise Reduction
 Thermal Protection: Three Thermal Fuses (128°C or 262°F)
 Overcurrent Protection: Three Fuses Protects 3 Modes
 Operating Temperature: -20°C to 55°C (-4 to 131°F)
 Storage Temperature: -40°C to 85°C (-40 to 185°F)

Mechanical

Terminal Identification: Brass = Hot, Nickel = Neutral, Green = Ground
 Terminal Accommodation: #14 – 10 AWG copper conductor only
 Product Identification: Ratings are a permanent part of device
 Weight: 125 grams

Environmental

Flammability: UL94 V2

Materials

Face: Nylon
 Body: Nylon
 Line Terminal: Olin #260 EH, 0.8mm thick
 Grounding Terminal: 70/30 Brass, 0.4mm thick (Uni-Ground Assembly)
 Mounting Strap: Super Dyma Cold-Rolled Steel, 1.2mm thick
 Clamping Plate: Cold-Rolled Steel, 1.6mm
Warranty: 1 year

Terminal Screws: Tri-Drive Brass #8 - 32 Hex Head
 Grounding Screw: Tri-Drive Steel (Green)
 Auto-Ground Clip: Stainless Steel
 Mounting Screws: Tri-Drive Zinc-Plated Steel
 LED: Green/Red
 Encapsulation: Conformal Coating
 Tamper Shutter: Thermoplastic

Conforms to the latest revision ANSI/IEEE C62.41 (formerly IEEE587), ANSI/IEEE C62.45.

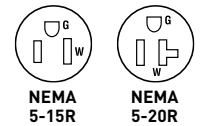

Project
Location/Type

TECHNICAL SPECIFICATIONS

Surge Protection Panels Heavy-, Medium- & Light-Duty

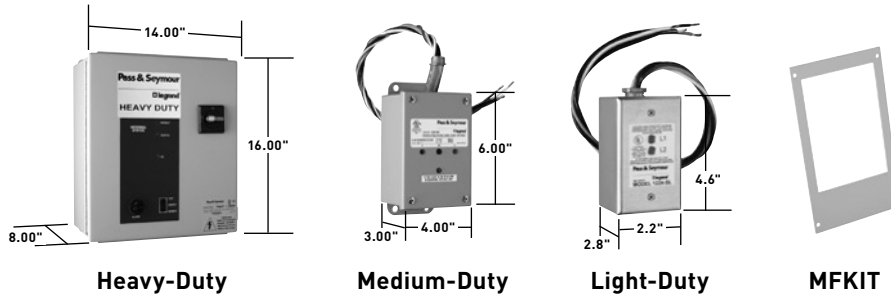

Typical Specifications

Manufacturer's Identification: Pass & Seymour® 1224SL
 3rd Party Compliance: UL Listed: Basic UL File Number – E324279; ML File Number – E332797.
 Standard UL1449, 3rd Edition (effective 9/29/09):

- Light Duty: UL1449 3rd Edition Type 2 SPD, cUL
- Medium Duty: UL1449 3rd Edition Type 2 SPD, cUL
- Heavy Duty: UL1449 3rd Edition Type 1 SPD

UL1283, CSA, CE, NEMA LS-1.

Performance

LED Indicators

Green LED is illuminated at all times while unit is functioning with no faults.
 A red LED will come on if any phase/mode has a fault.

Audible Alarm

Visible on the enclosure cover; will sound whenever surge protection is lost.

Rotary Disconnect Switch

Lockable only in the off position for increased safety.

NEMA 12 Enclosure

Epoxy painted steel with gasketing, rated for indoor operating use.

Three-Position Test Switch

Used for the audible alarm and LEDs – functions are: enable/switch/test.

Environmental

Recommended ambient temperature range: Designed for -40 degrees C to +60 degrees C,
 with a relative humidity of 0% to 5% (non-
 condensing)

Warranty: 5 years

Conforms to the latest revision ANSI/IEEE C62.41 (formerly IEEE587), ANSI/IEEE C62.45.

Project
Location/Type

TECHNICAL SPECIFICATIONS

Straight Blade Plugs 2 Pole, 3 Wire Grounding 15 & 20A, 125, 250 & 277V

Typical Specifications

Manufacturer's Identification: Pass & Seymour® PS5266X
 Description: Straight Blade Plug, Power Supply
 Type: 2 Pole, 3 Wire Grounding
 Rating: 15A, 125V
 Configuration: NEMA 5-15P
 3rd Party Compliance: UL Listed, File Number E146159, Standard UL498, Attachment Plugs and Receptacles. Federal Specification WC596. CSA Certified, File Number LR1765, Standard CSA-C22.2 No. 42, General Use Receptacles and Attachment Plugs. Conforms to NEMA WD-1 and WD-6.

CATALOG NUMBER	RATING	NEMA CONFIG. NO.	CATALOG NUMBER	RATING	NEMA CONFIG. NO.	NEMA CONFIG. NO.	AC HP RATING
☐ PS5266XHGX	15A 125V	5-15P	☐ PS5266XBK	15A 125V	5-15P	STRAIGHT BLADE HORSEPOWER RATING FOR NEMA CONFIGURATION 5-15 1/2 6-15 1 1/2* 7-15 2 5-20 1 6-20 2* 7-20 2 10-20 2 Line to Line* 1 Line to Neutral	
☐ PS5266HGANG	15A 125V	5-15P	☐ CR5266X	15A 125V	5-15P		
☐ PS5366XHGX	20A 125V	5-20P	☐ PS5366X	20A 125V	5-20P		
☐ PS5366HGANG	20A 125V	5-20P	☐ PS5366SSAN	20A 125V	5-20P		
☐ PS5666XHGX	15A 250V	6-15P	☐ PS5666X	15A 250V	6-15P		
☐ PS5666HGANG	15A 250V	6-15P	☐ PS5666SSAN	15A 250V	6-15P		
☐ PS5466XHGX	20A 250V	6-20P	☐ PS5466X	20A 250V	6-20P		
☐ PS5466HGANG	20A 250V	6-20P	☐ PS5466SSAN	20A 250V	6-20P		
☐ PS5266X	15A 125V	5-15P	☐ PS5766X	15A 277V	7-15P		
☐ PS5266SSAN	15A 125V	5-15P	☐ PS5866X	20A 277V	7-20P		
☐ PS5266XGRY	15A 125V	5-15P					

* Suitable for 208V motor applications at the HP rating specified.

Performance

Electrical

Dielectric Withstand Voltage: 1500V minimum
 Maximum Working Voltage: 277V
 Current Interrupting: Certified for current interrupting at full-rated current
 Temperature Rise: 30°C maximum after 50 cycles at 150% rated current

Mechanical

Cord Accommodation: Round portable service cords of diameters in accordance with the device rating as defined in UL62
 Cord Grip Accommodation: .230"-.720" diameter, Angle Plugs - .320"-.655"
 Terminal Identification: Green = Ground, White = Neutral, Brass = Hot
 Terminal Accommodation: #18 AWG min. - #10 AWG max.
 Product Identification: Amperage, Voltage, 3rd Party Compliance, NEMA Configuration

Environmental

Flammability: UL94 V2
 Operating Temperature: Maximum continuous +75°C, minimum -40°C without impact

Materials

Back Body:	Nylon	Terminal Clamp:	Zinc-Plated Steel**
Front Body:	Nylon	Terminal Screws:	Nickel- or Brass-Plated
Terminal Chamber:	Polycarbonate	Steel Ground Screws:	Nickel-Plated Steel Cord
Cord Clamp:	Nylon	Clamp Screws:	Nickel-Plated Steel #8
Insert:	Nylon	Assembly Screws:	Nickel-Plated Steel
Blades:	Brass**		

**Nickel-Plated for Corrosion-Resistant Product.
 Consult Straight Blade Plugs & Connectors Section F for complete compliance listing.

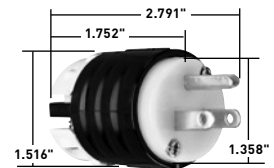
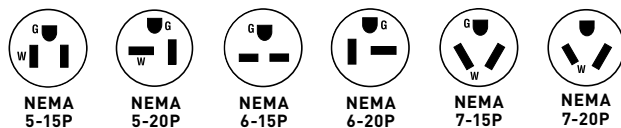

PS5266X



PS5266HGANG

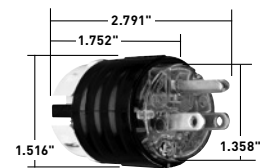

PS5266XHGX

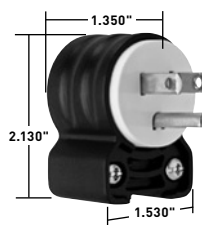

PS5266SSAN

Project
Location/Type

TECHNICAL SPECIFICATIONS

Straight Blade Connectors 2 Pole, 3 Wire Grounding 15 & 20A, 125 & 250V

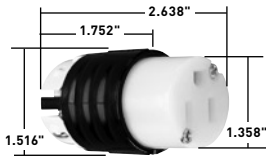

PS5269X

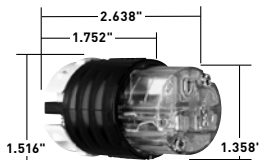

PS5269XHG

Typical Specifications

Manufacturer's Identification: Pass & Seymour® PS5269X
 Description: Straight Blade Connector, Power Supply
 Type: 2 Pole, 3 Wire Grounding
 Rating: 15A, 125V
 Configuration: NEMA 5-15R
 3rd Party Compliance: UL Listed, File Number E146159, Standard UL498, Attachment Plugs and Receptacles. Federal Specification WC596. CSA Certified, File Number LR1765, Standard CSA-C22.2 No. 42, General Use Receptacles and Attachment Plugs. Conforms to NEMA WD-1 and WD-6.

CATALOG NUMBER	RATING	NEMA CONFIG. NO.	CATALOG NUMBER	RATING	NEMA CONFIG. NO.	NEMA CONFIG. NO.	AC HP RATING
<input type="checkbox"/> PS5269XHG	15A 125V	5-15R	<input type="checkbox"/> PS5269XBK	15A 125V	5-15R	STRAIGHT BLADE HORSEPOWER RATING FOR NEMA CONFIGURATION 5-15 1/2 6-15 1 1/2* 7-15 2 5-20 1 6-20 2* 7-20 2 10-20 2 Line to Line* 1 Line to Neutral	
<input type="checkbox"/> PS5369XHG	20A 125V	5-20R	<input type="checkbox"/> CR5269X	15A 125V	5-15R		
<input type="checkbox"/> PS5669XHG	15A 250V	6-15R	<input type="checkbox"/> PS5369X	20A 125V	5-20R		
<input type="checkbox"/> PS5469XHG	20A 250V	6-20R	<input type="checkbox"/> PS5669X	15A 250V	6-15R		
<input type="checkbox"/> PS5269X	15A 125V	5-15R	<input type="checkbox"/> PS5469X	20A 250V	6-20R		
<input type="checkbox"/> PS5269XGRY	15A 125V	5-15R					

Performance

Electrical

Dielectric Withstand Voltage: 1500V minimum
 Maximum Working Voltage: 250V
 Current Interrupting: Certified for current interrupting at full-rated current
 Temperature Rise: 30°C maximum after 50 cycles at 150% rated current

Mechanical

Cord Accommodation: Round portable service cords of diameters in accordance with the device rating as defined in UL62
 Cord Grip Accommodation: .230"-.720" diameter
 Terminal Identification: Green = Ground, White = Neutral, Brass = Hot
 Terminal Accommodation: #18 AWG min. - #10 AWG max.
 Product Identification: Amperage, Voltage, 3rd Party Compliance, NEMA Configuration

Environmental

Flammability: UL94 V2
 Operating Temperature: Maximum continuous +75°C, minimum -40°C without impact

Materials

Terminal Clamp:	Zinc-Plated Steel**	Back Body:	Nylon
Terminal Screw:	Nickel- or Brass-Plated Steel	Front Body:	Nylon
Ground Screws:	Nickel-Plated Steel	Terminal Chamber:	Polycarbonate
Cord Clamp Screws:	Nickel-Plated Steel #8	Cord Clamp:	Nylon
Assembly Screws:	Nickel-Plated Steel	Insert:	Nylon
		Contacts:	Brass**

**Nickel-Plated for Corrosion-Resistant Product.
 Consult Straight Blade Plugs & Connectors Section F for complete compliance listing.

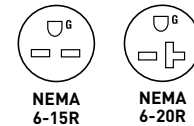
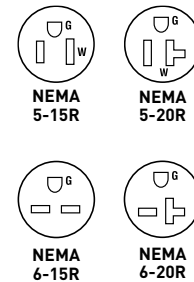

* Suitable for 208V motor applications at the HP rating specified.

Project
Location/Type



TECHNICAL SPECIFICATIONS

Straight Blade Ground Continuity Monitoring (GCM) Plugs

2 Pole, 3 Wire Grounding 15 & 20A, 125 & 250V

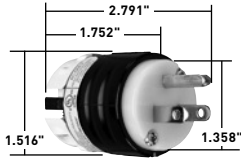

PS5266XGCM

Typical Specifications

Manufacturer's Identification: Pass & Seymour® PS5266XGCM
 Description: Straight Blade Plug, Power Supply
 Type: 2 Pole, 3 Wire Grounding
 Rating: 15A, 125V
 Configuration: NEMA 5-15P
 3rd Party Compliance: cULus Listed, File Number E146159, Standard UL498, Attachment Plugs and Receptacles. Federal Specification WC596. Standard CSA-C22.2 No. 42, General Use Receptacles and Attachment Plugs. Conforms to NEMA WD-1 and WD-6.

CATALOG NUMBER	RATING	NEMA CONFIG. NO.	CATALOG NUMBER	RATING	NEMA CONFIG. NO.	NEMA CONFIG. NO.	AC HP RATING
<input type="checkbox"/> PS5266XGCM	15A 125V	5-15P	<input type="checkbox"/> PS5666XGCM	15A 250V	6-15P	STRAIGHT BLADE HORSEPOWER RATING FOR NEMA CONFIGURATION	
<input type="checkbox"/> PS5266XGCMAN	15A 125V	5-15P	<input type="checkbox"/> PS5666XGCMAN	15A 250V	6-15P	5-15	1/2
<input type="checkbox"/> PS5366XGCM	20A 125V	5-20P	<input type="checkbox"/> PS5466XGCM	20A 250V	6-20P	6-15	1 1/2*
<input type="checkbox"/> PS5366XGCMAN	20A 125V	5-20P	<input type="checkbox"/> PS5466XGCMAN	20A 250V	6-20P	7-15	2
						5-20	1
						6-20	2*
						7-20	2
						10-20	2 Line to Line* 1 Line to Neutral

Performance

Electrical

Dielectric Withstand Voltage: 1500V minimum
 Maximum Working Voltage: 250V
 Current Interrupting: Certified for current interrupting at full-rated current
 Temperature Rise: 30°C maximum after 50 cycles at 150% rated current

Mechanical

Cord Accommodation: Round portable service cords of diameters in accordance with the device rating as defined in UL62 .230"-.720" diameter, Angle Plugs – .320"-.655"
 Cord Grip Accommodation: .230"-.720" diameter, Angle Plugs – .320"-.655"
 Terminal Identification: Green = Ground, White = Neutral, Brass = Hot
 Terminal Accommodation: #18 AWG min. – #10 AWG max.
 Product Identification: Amperage, Voltage, 3rd Party Compliance, NEMA Configuration

Environmental

Flammability: UL94 V2
 Operating Temperature: Maximum continuous +75°C, minimum -40°C without impact

Materials

Back Body:	Nylon	Terminal Clamp:	Zinc-Plated Steel
Front Body:	Nylon	Terminal Screws:	Nickel- or Brass-Plated Steel
Terminal Chamber:	Polycarbonate	Ground Screws:	Nickel-Plated Steel
Cord Clamp:	Nylon	Cord Clamp Screws:	Nickel-Plated Steel #8
Insert:	Nylon	Assembly Screws:	Nickel-Plated Steel
Blades:	Brass		

* Suitable for 208V motor applications at the HP rating specified.

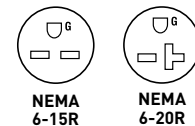
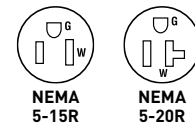

Consult Straight Blade Plugs & Connectors Section F for complete compliance listing.

Project
Location/Type



TECHNICAL SPECIFICATIONS

Straight Blade Ground Continuity Monitoring (GCM) Connectors

2 Pole, 3 Wire Grounding 15 & 20A, 125 & 250V

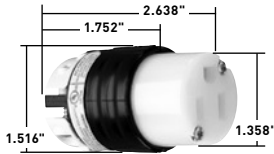

PS5269XGCM

Typical Specifications

Manufacturer's Identification: Pass & Seymour® PS5269XGCM
 Description: Straight Blade Connector, Power Supply
 Type: 2 Pole, 3 Wire Grounding
 Rating: 15A, 125V
 Configuration: NEMA 5-15R
 3rd Party Compliance: cULus Listed, File Number E146159, Standard UL498, Attachment Plugs and Receptacles. Federal Specification WC596. Standard CSA-C22.2 No. 42, General Use Receptacles and Attachment Plugs. Conforms to NEMA WD-1 and WD-6.

CATALOG NUMBER	RATING	NEMA CONFIG. NO.	CATALOG NUMBER	RATING	NEMA CONFIG. NO.	NEMA CONFIG. NO.	AC HP RATING
<input type="checkbox"/> PS5269XGCM	15A 125V	5-15R	<input type="checkbox"/> PS5669XGCM	15A 250V	6-15R	STRAIGHT BLADE HORSEPOWER RATING FOR NEMA CONFIGURATION	
<input type="checkbox"/> PS5369XGCM	20A 125V	5-20R	<input type="checkbox"/> PS5469XGCM	20A 250V	6-20R	5-15	1/2

Performance

Electrical

Dielectric Withstand Voltage: 1500V minimum
 Maximum Working Voltage: 250V
 Current Interrupting: Certified for current interrupting at full-rated current
 Temperature Rise: 30°C maximum after 50 cycles at 150% rated current

Mechanical

Cord Accommodation: Round portable service cords of diameters in accordance with the device rating as defined in UL62
 Cord Grip Accommodation: .230"-.720" diameter
 Terminal Identification: Green = Ground, White = Neutral, Brass = Hot
 Terminal Accommodation: #18 AWG min. - #10 AWG max.
 Product Identification: Amperage, Voltage, 3rd Party Compliance, NEMA Configuration

Environmental

Flammability: UL94 V2
 Operating Temperature: Maximum continuous +75°C, minimum -40°C without impact

Materials

Back Body: Nylon	Terminal Clamp: Zinc-Plated Steel
Front Body: Nylon	Terminal Screws: Nickel- or Brass-Plated Steel
Terminal Chamber: Polycarbonate	Ground Screws: Nickel-Plated Steel
Cord Clamp: Nylon	Cord Clamp Screws: Nickel-Plated Steel #8
Insert: Nylon	Assembly Screws: Nickel-Plated Steel
Contacts: Brass	

6-15	1 1/2*
7-15	2
5-20	1
6-20	2*
7-20	2
10-20	2 Line to Line* 1 Line to Neutral

* Suitable for 208V motor applications at the HP rating specified.

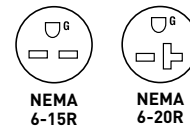
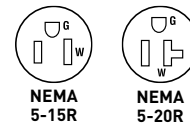

TECHNICAL SPECIFICATIONS

Consult Straight Blade Plugs & Connectors Section F for complete compliance listing.

Project
Location/Type

TECHNICAL SPECIFICATIONS

MaxGrip® M³ Plugs 2 Pole, 3 Wire Grounding 15 & 20A, 125 & 250V

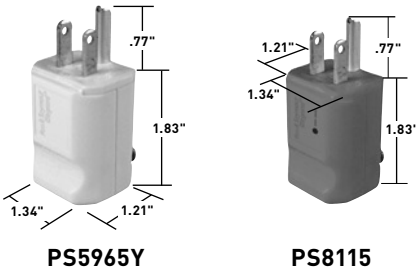

Typical Specifications

Manufacturer's Identification: Pass & Seymour® PS5965Y
 Description: Plug Straight Blade, Power Supply
 Type: 2 Pole, 3 Wire Grounding
 Rating: 15A, 125V
 Configuration: NEMA 5-15P
 3rd Party Compliance: UL Listed, File Number E146159, Standard UL498, Attachment Plugs and Receptacles. Federal Specification WC596. CSA Certified, File Number LR1765, Standard CSA-C22.2 No. 42, General Use Receptacles and Attachment Plugs. Conforms to NEMA WD-1 and WD-6.

CATALOG NUMBER	RATING	NEMA CONFIG. NO.	CATALOG NUMBER	RATING	NEMA CONFIG. NO.
<input type="checkbox"/> PS8115	15A 125V	5-15P	<input type="checkbox"/> PS5364Y	20A 125V	5-20P
<input type="checkbox"/> PS8115BK	15A 125V	5-15P	<input type="checkbox"/> PS5364GRY	20A 125V	5-20P
<input type="checkbox"/> PS5965Y	15A 125V	5-15P	<input type="checkbox"/> PS5666Y	15A 250V	6-15P
<input type="checkbox"/> PS5965GRY	15A 125V	5-15P	<input type="checkbox"/> PS5464Y	20A 250V	6-20P
<input type="checkbox"/> PS59650	15A 125V	5-15P			
<input type="checkbox"/> PS5965BK	15A 125V	5-15P			

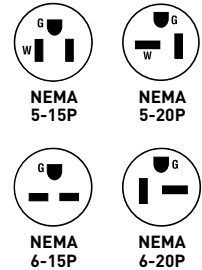

Performance

Electrical

Dielectric Withstand Voltage: 1500V minimum
 Maximum Working Voltage: 250V
 Current Interrupting: Certified for current interrupting at full-rated current
 Temperature Rise: 30°C, maximum after 50 cycles at 150% rated current

Mechanical

Cord Accommodation: Round portable service cords of diameters in accordance with the device rating as defined in UL62
 Cord Grip Accommodation: .230"-.720" diameter cord
 Terminal Identification: Green = Ground, Silver = Neutral, Brass = Hot
 Terminal Accommodation: #18 AWG min. – #12 AWG max.
 Product Identification: Amperage, Voltage, 3rd Party Compliance, NEMA Configuration

Environmental

Flammability: UL94 HB
 Operating Temperatures: Maximum continuous +75°C, minimum -40°C without impact

Materials

Body/Housing: Nylon	Ground Screw: Zinc-Plated Steel
Cord Grip Insert: Nylon	Blades: Brass
Terminal Clamp: Brass	Cord Clamp
Terminal Screws: Zinc- and Brass-Plated Steel	Assembly Screws: Zinc-Plated Steel

Consult Straight Blade Plugs & Connectors Section F for complete compliance listing.

Project
Location/Type

TECHNICAL SPECIFICATIONS

MaxGrip® M³ Connectors 2 Pole, 3 Wire Grounding 15 & 20A, 125 & 250V

PS5969Y

PS8119

Typical Specifications

Manufacturer's Identification: Pass & Seymour® PS5969Y

Description: Connector Straight Blade, Power Supply

Type: 2 Pole, 3 Wire Grounding

Rating: 15A, 125V

Configuration: NEMA 5-15R

3rd Party Compliance: UL Listed, File Number E146159, Standard UL498, Attachment Plugs and Receptacles. Federal Specification WC596. CSA Certified, File Number LR1765, Standard CSA-C22.2 No. 42, General Use Receptacles and Attachment Plugs. Conforms to NEMA WD-1 and WD-6.

CATALOG NUMBER	RATING	NEMA CONFIG. NO.	CATALOG NUMBER	RATING	NEMA CONFIG. NO.
<input type="checkbox"/> PS8119	15A 125V	5-15R	<input type="checkbox"/> PS5369Y	20A 125V	5-20R
<input type="checkbox"/> PS8119BK	15A 125V	5-15R	<input type="checkbox"/> PS5369GRY	20A 125V	5-20R
<input type="checkbox"/> PS5969Y	15A 125V	5-15R	<input type="checkbox"/> PS5669Y	15A 250V	6-15R
<input type="checkbox"/> PS5969GRY	15A 125V	5-15R	<input type="checkbox"/> PS5469Y	20A 250V	6-20R
<input type="checkbox"/> PS59690	15A 125V	5-15R			
<input type="checkbox"/> PS5969BK	15A 125V	5-15R			

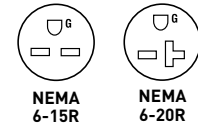
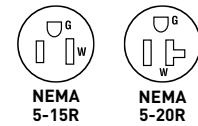

Performance

Electrical

Dielectric Withstand Voltage: 1500V minimum

Maximum Working Voltage: 250V

Current Interrupting: Certified for current interrupting at full-rated current

Temperature Rise: 30°C, maximum after 50 cycles at 150% rated current

Mechanical

Cord Accommodation: Round portable service cords of diameters in accordance with the device rating as defined in UL62

Cord Grip Accommodation: .230"-.720" diameter cord

Terminal Identification: Green = Ground, Silver = Neutral, Brass = Hot

Terminal Accommodation: #18 AWG min. - #12 AWG max.

Product Identification: Amperage, Voltage, 3rd Party Compliance, NEMA Configuration

Environmental

Flammability: UL94 HB

Operating Temperatures: Maximum continuous +75°C, minimum -40°C without impact

Materials

Body/Housing:	Nylon	Ground Screw:	Zinc-Plated Steel
Cord Grip Insert:	Nylon	Contacts:	Brass
Terminal Clamp:	Brass	Cord Clamp	
Terminal Screws:	Zinc- and Brass-Plated Steel	Assembly Screws:	Zinc-Plated Steel

Consult Straight Blade Plugs & Connectors Section F for complete compliance listing.

Project
Location/Type

TECHNICAL SPECIFICATIONS

Rubber Dust-Tight Plugs & Connectors 2 Pole, 3 Wire Grounding 15 & 20A, 125, 250 & 277V
 3 Pole, 4 Wire Grounding 20 & 30A, 125/250, 3ø250, 3ø480, 3ø600V; 3 Pole, 3 Wire 20A, 125/250V

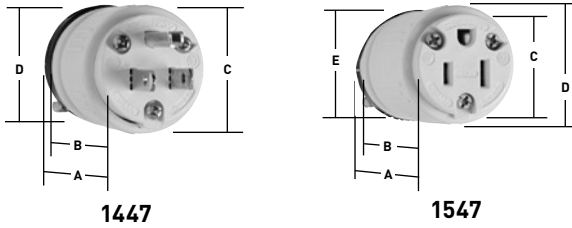

Typical Specifications

Manufacturer's Identification: Pass & Seymour® 1447
 Description: Rubber Dust-Tight Plugs & Connectors
 Type: 2 Pole, 3 Wire Grounding
 Rating: 15 & 20A, 125V & 250V
 Configuration: NEMA 5-15P
 UL Listed, Standard UL498, Attachment Plugs and Receptacles. Federal Specification WC596. CSA Certified Standard CSA-C22.2 No. 42, General Use Receptacles and Attachment Plugs. Conforms to NEMA WD-1.

CATALOG NUMBER	RATING	NEMA CONFIG. NO.	CATALOG NUMBER	RATING	NEMA CONFIG. NO.
□ 1447	15A 125V	5-15P	□ 1449	20A 125/250V	6-15P
□ 1547	15A 125V	5-15R	□ 1549	20A 125/250V	6-15R
□ 1433P	20A 125V	5-20P	□ 1448	30A 125/250V	6-20P
□ 1533	20A 125V	5-20R	□ 1548	30A 125/250V	6-20R

Performance

Electrical

Dielectric Withstand Voltage: 15A = 1600V minimum, 20A & 30A = 2200V minimum
 Maximum Working Voltage: 15A = 277VAC, 20 & 30A = 600VAC
 Current Interrupting: Certified for current interrupting at full-rated current
 Temperature Rise: 30°C maximum after 50 cycles at 150% rated current

Mechanical

Cord Accommodations: Round portable service cords of diameters in accordance with the device rating as defined in UL62
 Terminal Identification: 15A = Green = Ground, White = Neutral, Brass = Hot, 20A & 30A = "GR" and Green color = Ground, "WH" and White, color = Neutral, "X", "Y", "Z" = Hot
 Terminal Accommodation: 15A = #18 AWG min. - #10 AWG max.; 20A = #18 AWG min. - #8 AWG max.; 30A = #18 AWG min. - #6 AWG max.
 Product Identification: Amperage, Voltage, 3rd Party Compliance, NEMA Configuration hot stamped onto device

Environmental:

Flammability: UL94 V2
 Operating Temperatures: Maximum continuous +75°C, minimum -40°C without impact

Materials

Body:	Thermoplastic Elastomer	Ground Screws:	Zinc/Green-Plated
Terminal Chamber:	Polycarbonate		Brass, Hex-Head
Compression Nut:	Nylon	Assembly Screws:	Stainless Steel
Compression Grommet:	Thermoplastic Elastomer		
Dust Cover:	Thermoplastic Elastomer		
Plug Blades:	Brass		
Connector Contacts:	Brass		
Terminal Clamps:	Brass		
Terminal Screws Hot:	Brass		
Terminal Screws			
Hot/Neutral:	Zinc-Plated Brass		

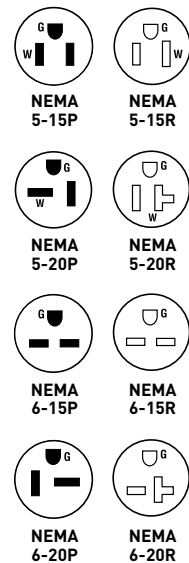

Project
Location/Type

TECHNICAL SPECIFICATIONS

Watertight Plugs, Connectors & Receptacles 2 Pole, 3 Wire Grounding 15 & 20A, 125/250, 250 & 277V

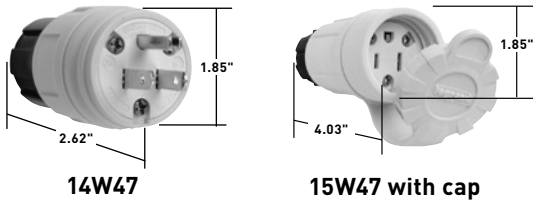

Typical Specifications

Manufacturer's Identification: Pass & Seymour® 24W47
 Description: Watertight Plugs, Connectors & Receptacles
 Type: 2 Pole, 3 Wire Grounding
 Rating: 15 & 20A, 125, 250 & 277V
 Configuration: NEMA L5-15P
 UL Listed, Standard UL498, Plugs and Connectors. Federal Specification WC596. CSA Certified Standard CSA-C22.2 No. 42, General Use Receptacles and Attachment Plugs. Conforms to NEMA WD-1, WD-6 and ANSI standards.

CATALOG NUMBER	RATING	NEMA CONFIG. NO.	CATALOG NUMBER	RATING	NEMA CONFIG. NO.
<input type="checkbox"/> 14W47	15V 125V	5-15P	<input type="checkbox"/> 14W49	15V 250V	6-15
<input type="checkbox"/> 15W47	15V 125V	5-15C	<input type="checkbox"/> 15W49	15V 250V	6-15
<input type="checkbox"/> 14W33	20V 125V	5-20	<input type="checkbox"/> 14W48	20V 250V	6-20
<input type="checkbox"/> 15W33	20V 125V	5-20	<input type="checkbox"/> 15W48	20V 250V	6-20

Performance

Electrical

Dielectric Withstand Voltage:

Connectors: 2000V AC if rated 300V or less; 3000V AC if rated above 300V
 Plugs: 2500V AC if rated 300V or less; 3500V AC if rated above 300V

Maximum Working Voltage: As marked

Current Interrupting: Rated for current interruption per UL498

Temperature Rise: 30°C maximum per UL498 at rated current

Mechanical

Cord & Terminal Accommodations:

Plugs & Connectors:

15A & 20A Straight Blade and 15A locking: Type S, S0, ST, SJ, SJO, SJT, 18/3 to 12/3, .300 min. to .625 in. max [7.6 to 15.9mm] dia.
 20A & 30A 3-wire locking: 12/3 SJ, 14/3 S to 10/3 S, [.475" to .720"] [12.1mm to 19.2mm]
 20A 4-wire locking: 14/4 S to 10/4 S, [.560" to .775"] [14.2mm to 19.9mm]
 30A 4-wire locking: 12/4 S to 8/4 S, 6/4 MSHA [.640" to .930"] [16.3mm to 23.6mm]

All 15A & 20A straight blade: 18 AWG to 12 AWG

20A locking & 30A 3-wire: 14 AWG to 10 AWG

30A 4-wire: 12 AWG to 6 AWG

Environmental

Moisture Resistance: NEMA 4, 4X, 12, 6, 6P (Plug & Connector only)

Flammability: UL94V0 (boxes & wiring device interiors)

Operating Temperature: -40°C (without impact) to +60°C continuous

UV resistance: All exposed materials are UV stabilized

Materials

Body/Contact Carrier:	PBT Thermoplastic, Yellow	Ferrule:	Polypropylene, Natural
Terminal Retainer:	Polycarbonate, Clear	Blades/Contacts:	Brass, Nickel
Housing:	Thermoplastic Elastomer, Yellow	Terminal Screws:	Steel, Chromate
Housing Insert:	Polypropylene, Natural	Terminal Screw Size:	#8-32
Strain Relief Nut:	PBT Thermoplastic, Black	Body Holding Screws:	Stainless Steel
Grommet:	Thermoplastic Elastomer, Various Colors	Drive Screws:	Steel, Chromate

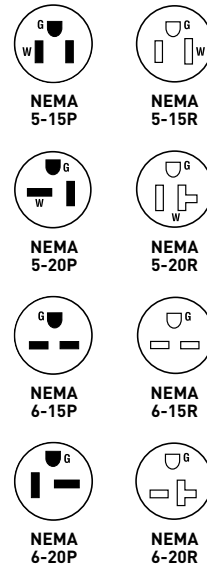

TECHNICAL SPECIFICATIONS

Project
Location/Type

TECHNICAL SPECIFICATIONS

Clamp-Lock™ Plugs & Connectors 2 Pole, 3 Wire Grounding 15A, 125 & 250V; 20A, 125V

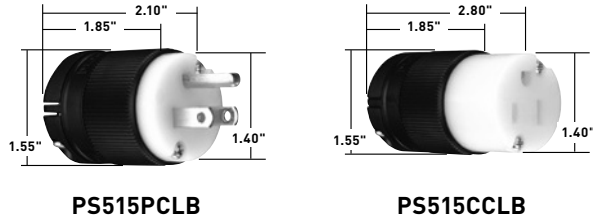

Typical Specifications

Manufacturer's Identification: Pass & Seymour® PS515PCLB
 Description: Connector Straight Blade, Power Supply
 Type: 2 Pole, 3 Wire Grounding
 Rating: 15A, 125V
 Configuration: NEMA 5-15R
 3rd Party Compliance: UL Listed, File Number E146159, Standard UL498, Attachment Plugs and Receptacles. Federal Specification WC596. CSA Certified, File Number LR1765, Standard CSA-C22.2 vNo. 42, General Use Receptacles and Attachment Plugs. Conforms to NEMA WD-1 and WD-6.

CATALOG NUMBER	RATING	NEMA CONFIG. NO.
<input type="checkbox"/> PS515PCLB	15A 125V	5-15P
<input type="checkbox"/> PS515CCLB	15A 125V	5-15R
<input type="checkbox"/> PS520PCLB	20A 125V	5-20P
<input type="checkbox"/> PS520CCLB	20A 125V	5-20R

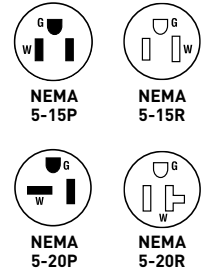

Performance

Electrical

Dielectric Withstand Voltage: 1500V minimum
 Maximum Working Voltage: 250V
 Current Interrupting: Certified for current interrupting at full-rated current
 Temperature Rise: 30°C, maximum after 50 cycles at 150% rated current

Mechanical

Cord Accommodation: Round portable service cords of diameters in accordance with the device rating as defined in UL62
 Cord Grip Accommodation: .20"-.470" diameter cord
 Terminal Identification: Green = Ground, Silver = Neutral, Brass = Hot
 Terminal Accommodation: #18 AWG min. – #12 AWG max.
 Product Identification: Amperage, Voltage, 3rd Party Compliance, NEMA Configuration

Environmental

Flammability: UL94 HB
 Operating Temperatures: Maximum continuous +75°C, minimum -40°C without impact

Materials

Body/Housing: Nylon
 Cord Grip Insert: Nylon
 Terminal Clamp: Brass
 Terminal Screws: Zinc- and Brass-Plated Steel
 Ground Screw: Zinc-Plated Steel
 Contacts: Brass
 Cord Clamp
 Assembly Screws: Zinc-Plated Steel

Consult Straight Blade Plugs & Connectors Section F for complete compliance listing.

Project
Location/Type

TECHNICAL SPECIFICATIONS

15A Turnlok® Receptacles

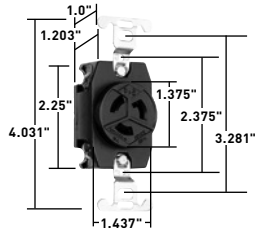

4710

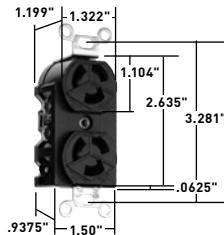

4700

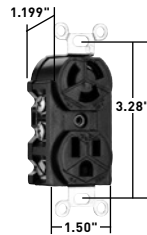

4792

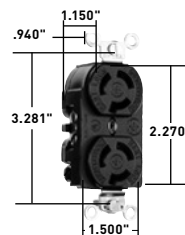

4550

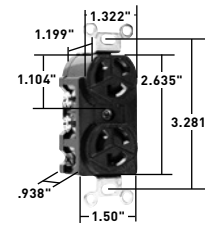

4750

Typical Specifications

Manufacturer's Identification: Pass & Seymour® 4700

Description: Locking Receptacle, Power Supply

Type: 2 Pole, 3 Wire Grounding

Rating: 15A, 125V

Configuration: NEMA L5-15R

3rd Party Compliance: UL Listed, File Number E146159, Standard UL498, Attachment Plugs and Receptacles. Federal Specification WC596. CSA Certified, File Number LR1765, Standard CSA-C22.2 No. 42, General Use Receptacles and Attachment Plugs. Conforms to NEMA WD-1 and WD-6.

AMPS	CATALOG NUMBER	NEMA CONFIG. NO.	AMPS	CATALOG NUMBER	NEMA CONFIG. NO.
15	☐ 4710	L5-15R	15	☐ 4550	L6-15R
15	☐ 4700	L5-15R	15	☐ 4760	L7-15R
15	☐ 4792	L5-15R	15	☐ 4750	L7-15R
15	☐ 4560	L5-15R			

Performance

Electrical

Dielectric Withstand Voltage: 2000V minimum

Maximum Working Voltage: 600VAC

Current Interrupting: Certified for current interrupting at full-rated current

Temperature Rise: 30°C max. after 50 cycles at 150% rated current

Mechanical

Terminal Accommodation: #18 AWG min. – #10 AWG max.

Product Identification: Amperage, Voltage, NEMA Configuration molded into face

Environmental

Flammability: UL94 V2

Operating Temperature: Maximum continuous +75°C, minimum -40°C without impact

Materials

Front Body: Nylon

Back Body: Nylon

Mounting Strap: Steel

Contacts: Brass

Terminal Clamps: Brass

Terminal Screws: Brass

Mounting Screws: Zinc-Plated Steel

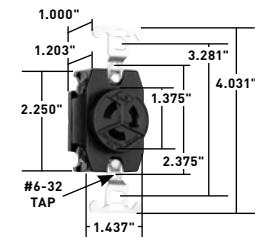

4760

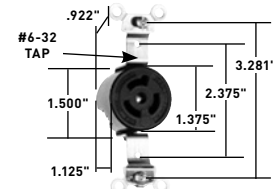

4560



NEMA L5-15R



NEMA L6-15R



NEMA L7-15R

Consult Turnlok® Section G for complete compliance listing.

Project
Location/Type

TECHNICAL SPECIFICATIONS

20A Turnlok® Receptacles

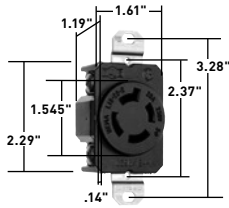

20A Receptacle

Typical Specifications

Manufacturer's Identification: Pass & Seymour® L520R
 Description: Locking Receptacle, Power Supply
 Type: 2 Pole, 3 Wire Grounding
 Rating: 20A, 125V
 Configuration: NEMA L5-20R
 3rd Party Compliance: UL Listed, File Number E146159, Standard UL498, Attachment Plugs and Receptacles. Federal Specification WC596. CSA Certified, File Number LR1765, Standard CSA-C22.2 No. 42, General Use Receptacles and Attachment Plugs. Conforms to NEMA WD-1 and WD-6.

AMPS	CATALOG NUMBER	NEMA CONFIG. NO.	AMPS	CATALOG NUMBER	NEMA CONFIG. NO.
20	<input type="checkbox"/> L520R	L5-20R	20	<input type="checkbox"/> L1420R	L14-20R
20	<input type="checkbox"/> CRL520R	L5-20R	20	<input type="checkbox"/> L1520R	L15-20R
20	<input type="checkbox"/> L620R	L6-20R	20	<input type="checkbox"/> L1620R	L16-20R
20	<input type="checkbox"/> L720R	L7-20R	20	<input type="checkbox"/> L1820R	L18-20R
20	<input type="checkbox"/> L820R	L8-20R	20	<input type="checkbox"/> L1920R	L19-20R
20	<input type="checkbox"/> L920R	L9-20R	20	<input type="checkbox"/> L2020R	L20-20R
20	<input type="checkbox"/> L1020R	L10-20R	20	<input type="checkbox"/> L2120R	L21-20R
20	<input type="checkbox"/> L1120R	L11-20R	20	<input type="checkbox"/> L2220R	L22-20R
20	<input type="checkbox"/> L1220R	L12-20R	20	<input type="checkbox"/> L2320R	L23-20R

Performance

Electrical

Dielectric Withstand Voltage: 2000V minimum
 Maximum Working Voltage: 600VAC
 Current Interrupting: Certified for current interrupting at full-rated current
 Temperature Rise: 30°C max. after 50 cycles at 150% rated current

Mechanical

Terminal Accommodation: #14 AWG min. – #10 AWG max.
 Product Identification: Amperage, Voltage, NEMA Configuration molded into face

Environmental

Flammability: UL94 V2
 Operating Temperature: Maximum continuous +75°C, minimum -40°C without impact

Materials

	Standard	Corrosion-Resistant
Front Body:	Nylon	Nylon
Back Body:	Nylon	Nylon
Mounting Strap:	Brass	Nickel-Plated Brass
Pressure Plate:	Brass	Nickel-Plated Brass
Contacts:	Brass	Nickel-Plated Brass
Terminal Clamps:	Brass	Nickel-Plated Brass
Terminal Screws:	Brass	Brass
Mounting Screws:	Zinc-Plated Steel	Stainless Steel

Consult Turnlok® Section G for complete compliance listing.

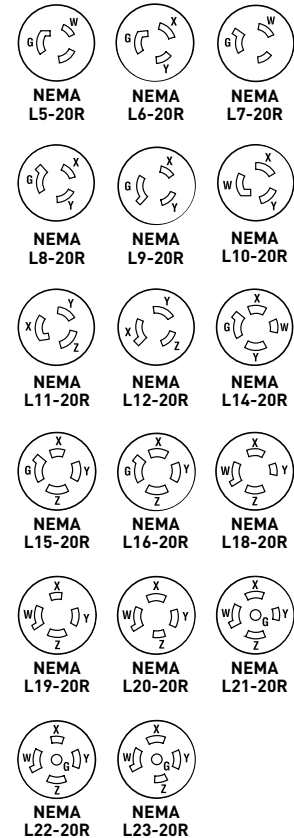

Project
Location/Type

TECHNICAL SPECIFICATIONS

30A Turnlok® Receptacles

Typical Specifications

Manufacturer's Identification: Pass & Seymour® L530R
 Description: Locking Receptacle, Power Supply
 Type: 2 Pole, 3 Wire Grounding
 Rating: 30A, 125V
 Configuration: NEMA L5-30R
 3rd Party Compliance: UL Listed, File Number E146159, Standard UL498, Attachment Plugs and Receptacles. Federal Specification WC596. CSA Certified, File Number LR1765, Standard CSA-C22.2 No. 42, General Use Receptacles and Attachment Plugs. Conforms to NEMA WD-1 and WD-6.

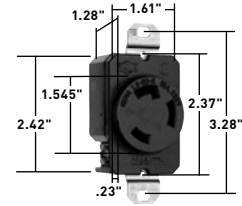

AMPS	CATALOG NUMBER	NEMA CONFIG. NO.	AMPS	CATALOG NUMBER	NEMA CONFIG. NO.
30	<input type="checkbox"/> L530R	L5-30R	30	<input type="checkbox"/> L1430R	L14-30R
30	<input type="checkbox"/> CRL530R	L5-30R	30	<input type="checkbox"/> L1530R	L15-30R
30	<input type="checkbox"/> L630R	L6-30R	30	<input type="checkbox"/> L1630R	L16-30R
30	<input type="checkbox"/> L730R	L7-30R	30	<input type="checkbox"/> L1730R	L17-30R
30	<input type="checkbox"/> L830R	L8-30R	30	<input type="checkbox"/> L1830R	L18-30R
30	<input type="checkbox"/> L930R	L9-30R	30	<input type="checkbox"/> L1930R	L19-30R
30	<input type="checkbox"/> L1030R	L10-30R	30	<input type="checkbox"/> L2030R	L20-30R
30	<input type="checkbox"/> L1130R	L11-30R	30	<input type="checkbox"/> L2130R	L21-30R
30	<input type="checkbox"/> L1230R	L12-30R	30	<input type="checkbox"/> L2230R	L22-30R
30	<input type="checkbox"/> L1330R	L13-30R	30	<input type="checkbox"/> L2330R	L23-30R

Performance

Electrical

Dielectric Withstand Voltage: 2000V minimum
 Maximum Working Voltage: 600VAC
 Current Interrupting: Certified for current interrupting at full-rated current
 Temperature Rise: 30°C max. after 50 cycles at 150% rated current

Mechanical

Terminal Accommodation: #14 AWG min. – #10 AWG max.
 Product Identification: Amperage, Voltage, NEMA Configuration molded into face

Environmental

Flammability: UL94 V2
 Operating Temperature: Maximum continuous +75°C, minimum -40°C without impact

Materials

	Standard	Corrosion-Resistant
Front Body:	Nylon	Nylon
Back Body:	Nylon	Nylon
Mounting Strap:	Brass	Nickel-Plated Brass
Pressure Plate:	Brass	Nickel-Plated Brass
Contacts:	Brass	Nickel-Plated Brass
Terminal Clamps:	Brass	Nickel-Plated Brass
Terminal Screws:	Brass	Brass
Mounting Screws:	Zinc-Plated Steel	Stainless Steel

Consult Turnlok® Section G for complete compliance listing.

30A Receptacle

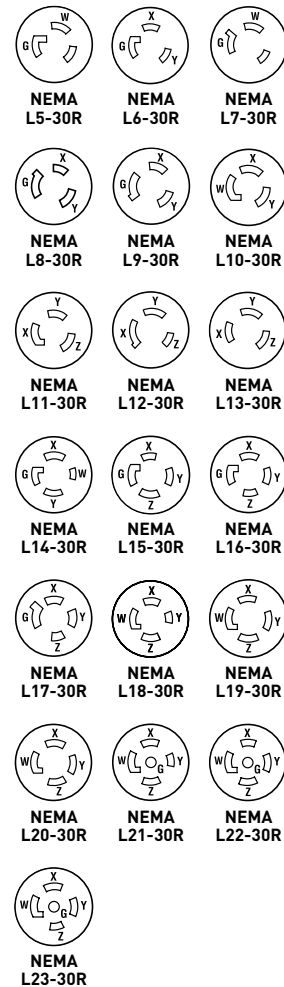

Project
Location/Type

TECHNICAL SPECIFICATIONS

15A Turnlok® EHU Plugs & Connectors

Typical Specifications

Manufacturer's Identification: Pass & Seymour® PSL515C
 Description: Locking Connector, Power Supply
 Type: 2 Pole, 3 Wire Grounding
 Rating: 15A, 125V
 Configuration: NEMA L5-15R
 3rd Party Compliance: UL Listed, File Number E146159, Standard UL498, Attachment Plugs and Receptacles. Federal Specification WC596. CSA Certified, File Number LR1765, Standard CSA-C22.2 No. 42, General Use Receptacles and Attachment Plugs. Conforms to NEMA WD-1 and WD-6.

AMPS	CATALOG NUMBER	NEMA CONFIG. NO.	AMPS	CATALOG NUMBER	NEMA CONFIG. NO.
15	☐ PSL515C	L5-15R	15	☐ PSL615C	L6-15R
15	☐ PSL515P	L5-15P	15	☐ PSL615P	L6-15P
15	☐ CRL515C	L5-15R	15	☐ PSL715C	L7-15R
15	☐ CRL515P	L5-15P	15	☐ PSL715P	L7-15P



15A Connector

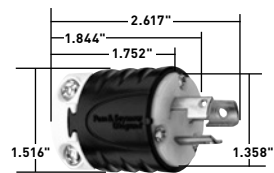

15A Plug

Performance

Electrical

Dielectric Withstand Voltage: 1600V minimum
 Max. Working Voltage: 277VAC
 Current Interrupting: Certified for current interrupting at full-rated current.
 Temperature Rise: 30°C max. after 50 cycles at 150% rated current.

Mechanical

Cord Accommodations: Round portable service cords of diameters in accordance with the device rating as defined in UL62.
 Cord Grip Accommodations: .230"-.720" diameter
 Terminal Identification: Green = Ground, White = Neutral, Brass = Hot
 Terminal Accommodation: #18 AWG min. - #10 AWG max.
 Product Identification: Amperage, Voltage, 3rd Party Compliance, NEMA Configuration

Environmental

Flammability: UL94 V2
 Operating Temperature: Maximum continuous +75°C, minimum -40°C without impact

Materials

Plugs

Back Body: Nylon
 Front Body: Nylon
 Terminal Chamber Separator: Polycarbonate
 Cord Clamp: Nylon
 Insert: Nylon
 Blades: Brass
 Terminal Clamp: Zinc-Plated Steel
 Terminal Screws: Nickel- or Brass-Plated Steel
 Ground Screws: Nickel-Plated Steel
 Cord Clamp Screws: Nickel-Plated Steel
 Assembly Screws: Nickel-Plated Steel

Standard

Corrosion-Resistant

Nylon
 Nylon
 Polycarbonate
 Nylon
 Nylon
 Nickel-Plated Brass
 Nickel-Plated Steel
 Nickel-Plated Steel
 Nickel-Plated Steel
 Nickel-Plated Steel
 Nickel-Plated Steel

Connectors

Back Body: Nylon
 Front Body: Nylon
 Terminal Chamber Separator: Polycarbonate
 Cord Clamp: Nylon
 Insert: Nylon
 Contacts: Brass
 Terminal Clamp: Zinc-Plated Steel
 Terminal Screws: Nickel- or Brass-Plated Steel
 Ground Screws: Nickel-Plated Steel
 Cord Clamp Screws: Nickel-Plated Steel
 Assembly Screws: Nickel-Plated Steel

Standard

Corrosion-Resistant

Nylon
 Nylon
 Polycarbonate
 Nylon
 Nylon
 Nickel-Plated Brass
 Nickel-Plated Steel
 Nickel-Plated Steel
 Nickel-Plated Steel
 Nickel-Plated Steel
 Nickel-Plated Steel

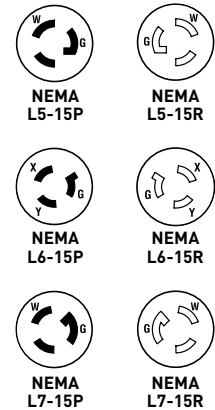

Consult Turnlok® Section G for complete compliance listing.

Project
Location/Type

TECHNICAL SPECIFICATIONS

20A Turnlok® Plugs

Typical Specifications

Manufacturer's Identification: Pass & Seymour® L520P
 Description: Locking Plug, Power Supply
 Type: 2 Pole, 3 Wire Grounding
 Rating: 20A, 125V
 Configuration: NEMA L5-20P
 3rd Party Compliance: UL Listed, File Number E146159, Standard UL498, Attachment Plugs and Receptacles. Federal Specification WC596. CSA Certified, File Number LR1765, Standard CSA-C22.2 No. 42, General Use Receptacles and Attachment Plugs. Conforms to NEMA WD-1 and WD-6.

AMPS	CATALOG NUMBER	NEMA CONFIG. NO.	AMPS	CATALOG NUMBER	NEMA CONFIG. NO.
20	☐ L520P	L5-20P	20	☐ L1520P	L15-20P
20	☐ L520PBK	L5-20P	20	☐ L1520PBK	L15-20P
20	☐ CRL520P	L5-20P	20	☐ L1620P	L16-20P
20	☐ L620P	L6-20P	20	☐ L1820P	L18-20P
20	☐ CRL620P	L6-20P	20	☐ L1920P	L19-20P
20	☐ L720P	L7-20P	20	☐ L2020P	L20-20P
20	☐ L820P	L8-20P	20	☐ L2120P	L21-20P
20	☐ L920P	L9-20P	20	☐ L2220P	L22-20P
20	☐ L1020P	L10-20P	20	☐ L2320P	L23-20P
20	☐ L1120P	L11-20P	20	☐ L3720P	L24-20P
20	☐ L1220P	L12-20P	20	☐ 7311SS	Non-NEMA
20	☐ L1420P	L14-20P	20	☐ 7411SS	Non-NEMA
20	☐ CRL1420P	L14-20P			

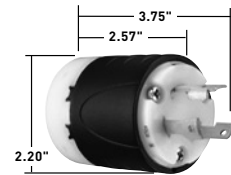

20A Plug

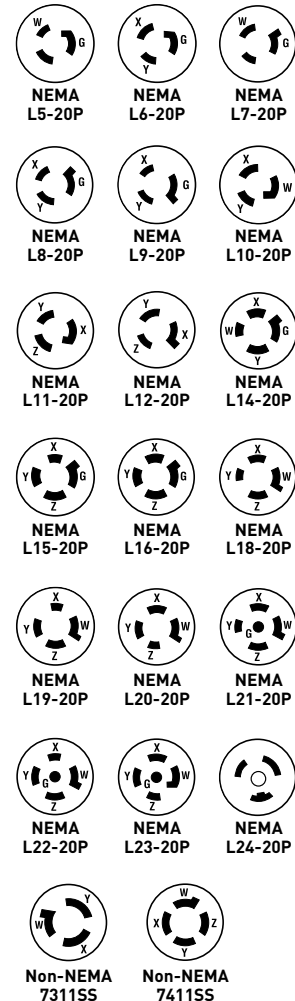

Performance

Electrical

Dielectric Withstand Voltage: 2200V minimum
 Maximum Working Voltage: 600VAC
 Current Interrupting: Certified for current interrupting at full-rated current
 Temperature Rise: 30°C maximum after 50 cycles at 150% rated current

Mechanical

Cord Accommodations: Round portable service cords of diameters in accordance with the device rating as defined in UL62
 Cord Grip Accommodations: All are .225"–1.150" diameter
 Terminal Identification: "GR" and Green Color = Ground, "WH" and White Color = Neutral, "X", "Y", "Z" = Hot
 Terminal Accommodation: #18 AWG min. – #8 AWG max.
 Product Identification: Amperage, Voltage, 3rd Party Compliance, NEMA Configuration hot stamped onto device

Environmental

Flammability: UL94 V2
 Operating Temperature: Maximum continuous +75°C, minimum -40°C without impact

Materials

	Standard	Corrosion-Resistant
Back Body:	Super Tough Nylon	Super Tough Nylon
Front Body:	Nylon	Nylon
Terminal Chamber:	Polycarbonate	Polycarbonate
Cord Clamp:	Nylon	Nylon
Insert:	Nylon	Nylon
Dust Cover:	Neoprene	Neoprene
Blades:	Brass	Nickel-Plated Brass
Terminal Clamp:	Nickel-Plated Steel	Nickel-Plated Steel
Terminal Screws:	Brass	Nickel-Plated Brass
Ground Screws:	Brass	Nickel-Plated Brass
Cord Clamp Screws:	Nickel-Plated Steel	Nickel-Plated Steel
Assembly Screws:	Nickel-Plated Steel	Nickel-Plated Steel

Consult Turnlok® Section G for complete compliance listing.

TECHNICAL SPECIFICATIONS

Project
Location/Type

TECHNICAL SPECIFICATIONS

20A Turnlok® Connectors

Typical Specifications

Manufacturer's Identification: Pass & Seymour® L520C
 Description: Locking Connector, Power Supply
 Type: 2 Pole, 3 Wire Grounding
 Rating: 20A, 125V
 Configuration: NEMA L5-20R
 3rd Party Compliance: UL Listed, File Number E146159, Standard UL498, Attachment Plugs and Receptacles. Federal Specification WC596. CSA Certified, File Number LR1765, Standard CSA-C22.2 No. 42, General Use Receptacles and Attachment Plugs. Conforms to NEMA WD-1 and WD-6.

AMPS	CATALOG NUMBER	NEMA CONFIG. NO.	AMPS	CATALOG NUMBER	NEMA CONFIG. NO.
20	☐ L520C	L5-20R	20	☐ CRL1420C	L14-20R
20	☐ L520CBK	L5-20R	20	☐ L1520C	L15-20R
20	☐ CRL520C	L5-20R	20	☐ L1520CBK	L15-20R
20	☐ L620C	L6-20R	20	☐ L1620C	L16-20R
20	☐ CRL620C	L6-20R	20	☐ L1820C	L18-20R
20	☐ L720C	L7-20R	20	☐ L1920C	L19-20R
20	☐ L820C	L8-20R	20	☐ L2020C	L20-20R
20	☐ L920C	L9-20R	20	☐ L2120C	L21-20R
20	☐ L1020C	L10-20R	20	☐ L2220C	L22-20R
20	☐ L1120C	L11-20R	20	☐ L2320C	L23-20R
20	☐ L1220C	L12-20R	20	☐ L3720C	L24-20R
20	☐ L1420C	L14-20R	20	☐ 7313SS	Non-NEMA

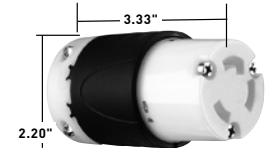

20A Connector

Performance

Electrical

Dielectric Withstand Voltage: 2200V minimum
 Maximum Working Voltage: 600VAC
 Current Interrupting: Certified for current interrupting at full-rated current
 Temperature Rise: 30°C maximum after 50 cycles at 150% rated current

Mechanical

Cord Accommodations: Round portable service cords of diameters in accordance with the device rating as defined in UL62
 Cord Grip Accommodations: All are .225"-1.150" diameter
 Terminal Identification: "GR" and Green Color = Ground, "WH" and White Color = Neutral, "X", "Y", "Z" = Hot
 Terminal Accommodation: #18 AWG min. - #8 AWG max.
 Product Identification: Amperage, Voltage, 3rd Party Compliance, NEMA Configuration hot stamped onto device

Environmental

Flammability: UL94 V2
 Operating Temperature: Maximum continuous +75°C, minimum -40°C without impact

Materials

	Standard	Corrosion-Resistant
Back Body:	Super Tough Nylon	Super Tough Nylon
Front Body:	Nylon	Nylon
Terminal Chamber:	Polycarbonate	Polycarbonate
Cord Clamp:	Nylon	Nylon
Insert:	Nylon	Nylon
Dust Cover:	Neoprene	Neoprene
Contacts:	Brass	Nickel-Plated Brass
Terminal Clamp:	Nickel-Plated Steel	Nickel-Plated Steel
Terminal Screws:	Brass	Nickel-Plated Brass
Ground Screws:	Brass	Nickel-Plated Brass
Cord Clamp Screws:	Nickel-Plated Steel	Nickel-Plated Steel
Assembly Screws:	Nickel-Plated Steel	Nickel-Plated Steel

Consult Turnlok® Section G for complete compliance listing.

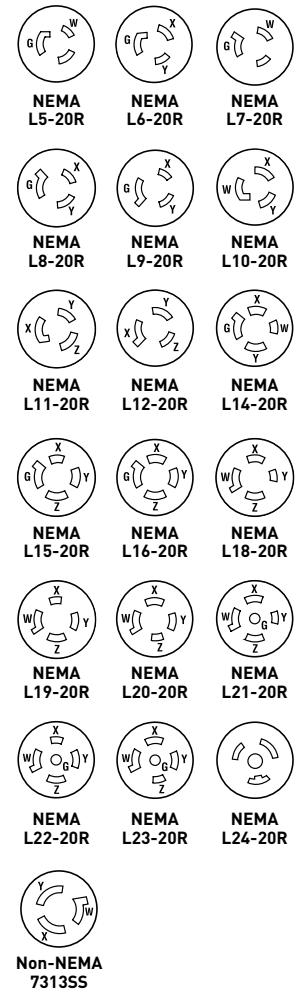

Project
Location/Type

TECHNICAL SPECIFICATIONS

30A Turnlok® Plugs

Typical Specifications

Manufacturer's Identification: Pass & Seymour® L530P
 Description: Locking Plug, Power Supply
 Type: 2 Pole, 3 Wire Grounding
 Rating: 30A, 125V
 Configuration: NEMA L5-30P
 3rd Party Compliance: UL Listed, File Number E146159, Standard UL498, Attachment Plugs and Receptacles. Federal Specification WC596. CSA Certified, File Number LR1765, Standard CSA-C22.2 No. 42, General Use Receptacles and Attachment Plugs. Conforms to NEMA WD-1 and WD-6.

AMPS	CATALOG NUMBER	NEMA CONFIG. NO.	AMPS	CATALOG NUMBER	NEMA CONFIG. NO.
30	□ L530P	L5-30P	30	□ L1530P	L15-30P
30	□ CRL530P	L5-30P	30	□ L1630P	L16-30P
30	□ L630P	L6-30P	30	□ L1730P	L17-30P
30	□ CRL630P	L6-30P	30	□ L1830P	L18-30P
30	□ L730P	L7-30P	30	□ L1930P	L19-30P
30	□ L830P	L8-30P	30	□ L2030P	L20-30P
30	□ L930P	L9-30P	30	□ L2130P	L21-30P
30	□ L1030P	L10-30P	30	□ L2230P	L22-30P
30	□ L1130P	L11-30P	30	□ L2230PBK	L22-30P
30	□ L1230P	L12-30P	30	□ L2330P	L23-30P
30	□ L1330P	L13-30P	30	□ 3331SS	Non-NEMA
30	□ L1430P	L14-30P	30	□ 3431SS	Non-NEMA
30	□ CRL1430P	L14-30P			

Performance

Electrical

Dielectric Withstand Voltage: 2200V minimum
 Maximum Working Voltage: 600VAC
 Current Interrupting: Certified for current interrupting at full-rated current
 Temperature Rise: 30°C maximum after 50 cycles at 150% rated current

Mechanical

Cord Accommodations: Round portable service cords of diameters in accordance with the device rating as defined in UL62
 Cord Grip Accommodations: All are .225"–1.150" diameter
 Terminal Identification: "GR" and Green Color = Ground, "WH" and White Color = Neutral, "X", "Y", "Z" = Hot
 Terminal Accommodation: #18 AWG min. – #8 AWG max.
 Product Identification: Amperage, Voltage, 3rd Party Compliance, NEMA Configuration hot stamped onto device

Environmental

Flammability: UL94 V2
 Operating Temperature: Maximum continuous +75°C, minimum -40°C without impact

Materials

	Standard	Corrosion-Resistant
Back Body:	Super Tough Nylon	Super Tough Nylon
Front Body:	Nylon	Nylon
Terminal Chamber:	Polycarbonate	Polycarbonate
Cord Clamp:	Nylon	Nylon
Insert:	Nylon	Nylon
Dust Cover:	Neoprene	Neoprene
Blades:	Brass	Tin-Plated Brass
Terminal Clamp:	Brass	Nickel-Plated Brass
Terminal Screws:	Brass	Nickel-Plated Brass
Ground Screws:	Brass	Nickel-Plated Brass
Cord Clamp Screws:	Nickel-Plated Steel	Nickel-Plated Steel
Assembly Screws:	Nickel-Plated Steel	Nickel-Plated Steel

Consult Turnlok® Section G for complete compliance listing.

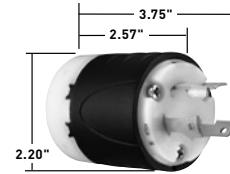

30A Plug

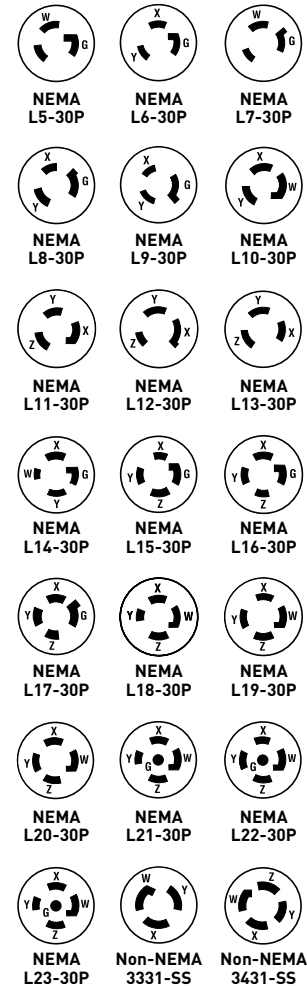

Project
Location/Type

TECHNICAL SPECIFICATIONS

30A Turnlok® Connectors

Typical Specifications

Manufacturer's Identification: Pass & Seymour® L530C
 Description: Locking Connector, Power Supply
 Type: 2 Pole, 3 Wire Grounding
 Rating: 30A, 125V
 Configuration: NEMA L5-30R
 3rd Party Compliance: UL Listed, File Number E146159, Standard UL498, Attachment Plugs and Receptacles. Federal Specification WC596. CSA Certified, File Number LR1765, Standard CSA-C22.2 No. 42, General Use Receptacles and Attachment Plugs. Conforms to NEMA WD-1 and WD-6.

AMPS	CATALOG NUMBER	NEMA CONFIG. NO.	AMPS	CATALOG NUMBER	NEMA CONFIG. NO.
30	☐ L530C	L5-30R	30	☐ L1530C	L15-30R
30	☐ CRL530C	L5-30R	30	☐ L1630C	L16-30R
30	☐ L630C	L6-30R	30	☐ L1730C	L17-30R
30	☐ CRL630C	L6-30R	30	☐ L1830C	L18-30R
30	☐ L730C	L7-30R	30	☐ L1930C	L19-30R
30	☐ L830C	L8-30R	30	☐ L2030C	L20-30R
30	☐ L930C	L9-30R	30	☐ L2130C	L21-30R
30	☐ L1030C	L10-30R	30	☐ L2230C	L22-30R
30	☐ L1130C	L11-30R	30	☐ L2330C	L23-30R
30	☐ L1230C	L12-30R	30	☐ 3333SS	Non-NEMA
30	☐ L1330C	L13-30R	30	☐ 3433SS	Non-NEMA
30	☐ L1430C	L14-30R			
30	☐ CRL1430C	L14-30R			

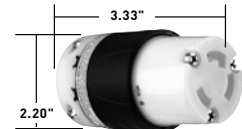

30A Connector

Performance

Electrical

Dielectric Withstand Voltage: 2200V minimum
 Maximum Working Voltage: 600VAC
 Current Interrupting: Certified for current interrupting at full-rated current
 Temperature Rise: 30°C maximum after 50 cycles at 150% rated current

Mechanical

Cord Accommodations: Round portable service cords of diameters in accordance with the device rating as defined in UL62
 Cord Grip Accommodations: All are .225"-1.150" diameter
 Terminal Identification: "GR" and Green Color = Ground, "WH" and White Color = Neutral, "X", "Y", "Z" = Hot
 Terminal Accommodation: #18 AWG min. - #8 AWG max.
 Product Identification: Amperage, Voltage, 3rd Party Compliance, NEMA Configuration hot stamped onto device

Environmental

Flammability: UL94 V2
 Operating Temperature: Maximum continuous +75°C, minimum -40°C without impact

Materials

	Standard	Corrosion-Resistant
Back Body:	Super Tough Nylon	Super Tough Nylon
Front Body:	Nylon	Nylon
Terminal Chamber:	Polycarbonate	Polycarbonate
Cord Clamp:	Nylon	Nylon
Insert:	Nylon	Nylon
Dust Cover:	Neoprene	Neoprene
Contacts:	Brass	Tin-Plated Brass
Terminal Clamp:	Brass	Nickel-Plated Brass
Terminal Screws:	Brass	Nickel-Plated Brass
Ground Screws:	Brass	Nickel-Plated Brass
Cord Clamp Screws:	Nickel-Plated Steel	Nickel-Plated Steel
Assembly Screws:	Nickel-Plated Steel	Nickel-Plated Steel

Consult Turnlok® Section G for complete compliance listing.

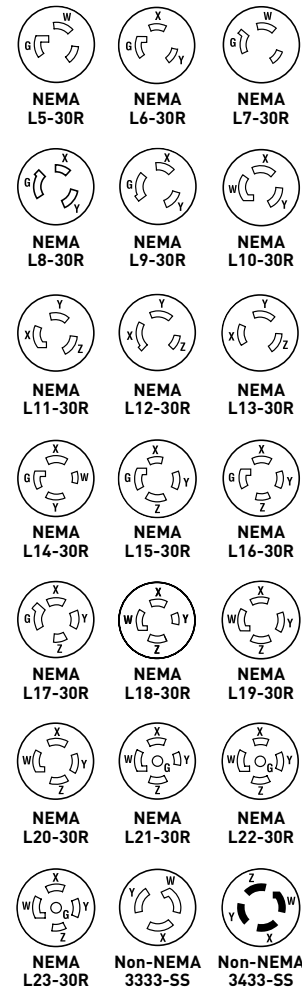

Project
Location/Type

TECHNICAL SPECIFICATIONS



TECHNICAL SPECIFICATIONS

Turnlok® Heavy-Duty Ground Continuity Monitoring (GCM) Plugs

15, 20 & 30A; 125, 250, 277 & 347V, 125/250V

Typical Specifications

Manufacturer's Identification: Pass & Seymour® PSL515PGCM
 Description: Ground Continuity Monitoring (GCM) Locking Plug, Power Supply
 Type: 2 Pole, 3 Wire Grounding
 Rating: 15A, 125V
 Configuration: NEMA 5-15P
 3rd Party Compliance: cULus Listed, File Number E146159, Standard UL498, Attachment Plugs and Receptacles. Federal Specification WC596. Standard CSA-C22.2 No. 42, General Use Receptacles and Attachment Plugs. Conforms to NEMA WD-1 and WD-6.

CATALOG NUMBER	RATING	NEMA CONFIG. NO.	CATALOG NUMBER	RATING	NEMA CONFIG. NO.
<input type="checkbox"/> PSL515PGCM	15 125	L5-15P	<input type="checkbox"/> PSL715PGCM	15 277	L7-15P
<input type="checkbox"/> L520PGCM	20 125	L5-20P	<input type="checkbox"/> L720PGCM	20 277	L7-20P
<input type="checkbox"/> L530PGCM	30 125	L5-30P	<input type="checkbox"/> L730PGCM	30 277	L7-30P
<input type="checkbox"/> PSL615PGCM	15 250	L6-15P	<input type="checkbox"/> L3720PGCM	20 347	L24-20P
<input type="checkbox"/> L620PGCM	20 250	L6-20P	<input type="checkbox"/> L1420PGCM	20 125/250	L14-20P
<input type="checkbox"/> L630PGCM	30 250	L6-30P	<input type="checkbox"/> L1430PGCM	30 125/250	L14-30P

Performance

Electrical

Dielectric Withstand Voltage: 15A = 1600V minimum, 20 & 30A = 2200V minimum
 Maximum Working Voltage: 15A = 277VAC, 20 & 30A = 600VAC
 Current Interrupting: Certified for current interrupting at full-rated current
 Temperature Rise: 30°C maximum after 50 cycles at 150% rated current

Mechanical

Cord Accommodations: Round portable service cords of diameters in accordance with the device rating as defined in UL62
 Cord Grip Accommodations: 15A = .230"-.720" diameter, 20 & 30A 3 Wire = .225"-1.150" diameter, 20 & 30A 4 & 5 Wire = .225"-1.150" diameter
 Terminal Identification: 15A = Green = Ground, White = Neutral, Brass = Hot
 20 & 30A = "GR" and Green Color = Ground, "WH" and white Color = Neutral, "X", "Y", "Z" = Hot
 Terminal Accommodation: 15A = #18 AWG min. - #10 AWG max.
 20A = #18 AWG min. - # 8 AWG max.
 30A = #18 AWG min. - # 6 AWG max.
 Product Identification: Amperage, Voltage, 3rd Party Compliance, NEMA Configuration hot stamped onto device

Environmental

Flammability: UL94 V2
 Operating Temperature: Maximum continuous +75°C, minimum -40°C without impact

Materials

Back Body: Super Tough Nylon
 Front Body: Nylon
 Terminal Chamber: Polycarbonate
 Cord Clamp: Nylon
 Insert: Nylon
 Dust Shield:* Neoprene
 Blades: Brass
 Terminal Clamp: 15A = Zinc-Plated Steel
 20A = Nickel-Plated Steel
 30A = Brass
 Terminal Screws: 15A = Nickel- or Brass-Plated Steel
 20 & 30A = Brass
 Ground Screws: 15A = Nickel-Plated Steel
 20 & 30A = Brass
 Cord Clamp Screws: Nickel-Plated Steel
 Assembly Screws: Nickel-Plated Steel

*Dust Shield for 20 & 30 Amp Plugs. Consult Turnlok® Section G for complete compliance listing.

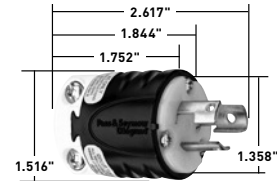

15A Plug

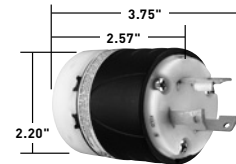

20 & 30A Plug

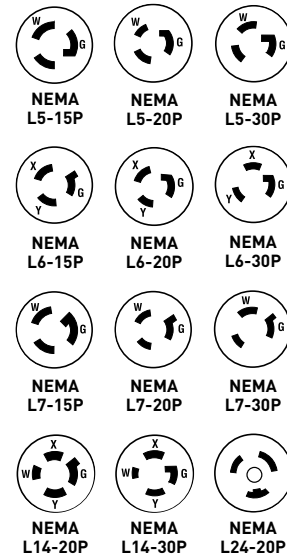

Project
Location/Type



TECHNICAL SPECIFICATIONS

Turnlok® Heavy-Duty Ground Continuity Monitoring (GCM) Connectors

15, 20 & 30A; 125, 250, 277 & 347V, 125/250V

Typical Specifications

Manufacturer's Identification: Pass & Seymour® PSL515CGCM
 Description: Ground Continuity Monitoring (GCM) Locking Connector, Power Supply
 Type: 2 Pole, 3 Wire Grounding
 Rating: 15A, 125V
 Configuration: NEMA 5-15R
 3rd Party Compliance: cULus Listed, File Number E146159, Standard UL498, Attachment Plugs and Receptacles. Federal Specification WC596. Standard CSA-C22.2 No. 42, General Use Receptacles and Attachment Plugs. Conforms to NEMA WD-1 and WD-6.

CATALOG NUMBER	RATING	NEMA CONFIG. NO.	CATALOG NUMBER	RATING	NEMA CONFIG. NO.
☐ PSL515CGCM	15 125	L5-15R	☐ PSL715CGCM	15 277	L7-15R
☐ L520CGCM	20 125	L5-20R	☐ L720CGCM	20 277	L7-20R
☐ L530CGCM	30 125	L5-30R	☐ L730CGCM	30 277	L7-30R
☐ PSL615CGCM	15 250	L6-15R	☐ L3720CGCM	20 347	L24-20R
☐ L620CGCM	20 250	L6-20R	☐ L1420CGCM	20 125/250	L14-20R
☐ L630CGCM	30 250	L6-30R	☐ L1430CGCM	30 125/250	L14-30R

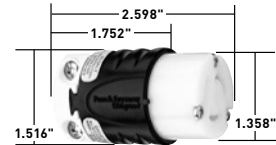

15A Connector

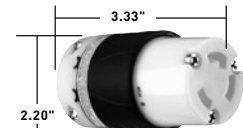

30A Connector

Performance

Electrical

Dielectric Withstand Voltage: 15A = 1600V minimum, 20 & 30A = 2200V minimum
 Maximum Working Voltage: 15A = 277VAC, 20 & 30A = 600VAC
 Current Interrupting: Certified for current interrupting at full-rated current
 Temperature Rise: 30°C maximum after 50 cycles at 150% rated current

Mechanical

Cord Accommodations: Round portable service cords of diameters in accordance with the device rating as defined in UL62
 Cord Grip Accommodations: 15A = .230"-.720" diameter, 20 & 30A 3 Wire = .225"-.1.150" diameter, 20 & 30A 4 & 5 Wire = .225"-.1.150" diameter
 Terminal Identification: 15A = Green = Ground, White = Neutral, Brass = Hot
 20 & 30A = "GR" and Green Color = Ground, "WH" and white Color = Neutral, "X", "Y", "Z" = Hot
 Terminal Accommodation: 15A = #18 AWG min. - #10 AWG max.
 20A = #18 AWG min. - #8 AWG max.
 30A = #18 AWG min. - #6 AWG max.
 Product Identification: Amperage, Voltage, 3rd Party Compliance, NEMA Configuration hot stamped onto device

Environmental

Flammability: UL94 V2
 Operating Temperature: Maximum continuous +75°C, minimum -40°C without impact

Materials

Back Body: Super Tough Nylon
 Front Body: Nylon
 Terminal Chamber: Polycarbonate
 Cord Clamp: Nylon
 Insert: Nylon
 Dust Shield:* Neoprene
 Contacts: Brass
 Terminal Clamp: 15A = Zinc-Plated Steel
 20A = Nickel-Plated Steel
 30A = Brass
 Terminal Screws: 15A = Nickel- or Brass-Plated Steel
 20 & 30A = Brass
 Ground Screws: 15A = Nickel-Plated Steel
 20 & 30A = Brass
 Cord Clamp Screws: Nickel-Plated Steel
 Assembly Screws: Nickel-Plated Steel

*Dust Shield for 20 & 30A Connectors. Consult Turnlok® Section G for complete compliance listing.

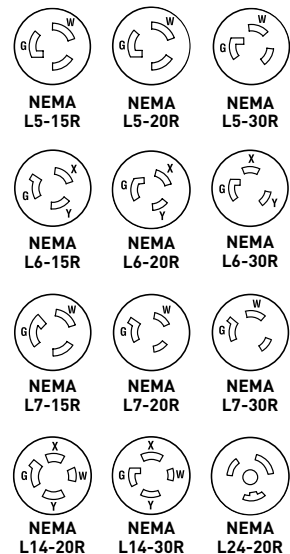

Project
Location/Type

TECHNICAL SPECIFICATIONS

15A Turnlok® Flanged Inlets & Outlets

Typical Specifications

Manufacturer's Identification: Pass & Seymour® 4715SS
 Description: Locking Flanged Outlet, Power Supply
 Type: 2 Pole, 3 Wire Grounding
 Rating: 15A, 125V
 Configuration: NEMA L5-15R
 3rd Party Compliance: UL Listed, File Number E146159, Standard UL498, Attachment Plugs and Receptacles. Federal Specification WC596. CSA Certified, File Number LR1765, Standard CSA-C22.2 No. 42, General Use Receptacles and Attachment Plugs. Conforms to NEMA WD-1 and WD-6.

AMPS	CATALOG NUMBER	NEMA CONFIG. NO.	AMPS	CATALOG NUMBER	NEMA CONFIG. NO.
15	□ 4715SS	L5-15R	15	□ 4716SS	L5-15P

Performance

Electrical

Dielectric Withstand Voltage: 2000V minimum
 Maximum Working Voltage: 277VAC
 Current Interrupting: Certified for current interrupting at full-rated current
 Temperature Rise: 30°C max. after 50 cycles at 150% rated current

Mechanical

Terminal Identification: Green = Ground, White = Neutral, Brass = Hot
 Terminal Accommodation: #18 AWG min. – #10 AWG max.
 Product Identification: Amperage, Voltage, 3rd Party Compliance, NEMA Configuration

Environmental

Flammability: UL94 V2
 Operating Temperature: Maximum continuous +115°C, minimum -40°C without impact

Materials

	Inlet	Outlet
Flanged Casing:	Polycarbonate	Polycarbonate
Body Contact:	Polycarbonate	Polycarbonate
Blades:	Nickel-Plated Brass	Brass
Terminal Clamp:	Zinc-Plated Steel	Zinc-Plated Steel
Terminal Screws:	Zinc- or Brass-Plated Steel	Zinc- or Brass-Plated Steel
Ground Screws:	Zinc-Plated Steel	Zinc-Plated Steel
Assembly Screws:	Zinc-Plated Steel	Zinc-Plated Steel

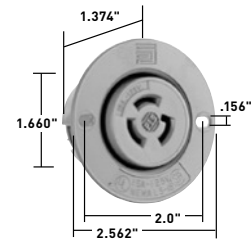
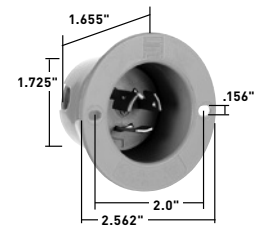
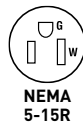
4715SS

4716SS

Consult Turnlok® Section G for complete compliance listing.

Project
Location/Type

TECHNICAL SPECIFICATIONS

20A Turnlok® Flanged Inlets

Typical Specifications

Manufacturer's Identification: Pass & Seymour® L520FI
 Description: Locking Flanged Inlet, Power Supply
 Type: 2 Pole, 3 Wire Grounding
 Rating: 20A, 125V
 Configuration: NEMA L5-20P
 3rd Party Compliance: UL Listed, File Number E146159, Standard UL498, Attachment Plugs and Receptacles. Federal Specification WC596. CSA Certified, File Number LR1765, Standard CSA-C22.2 No. 42, General Use Receptacles and Attachment Plugs. Conforms to NEMA WD-1 and WD-6.

AMPS	CATALOG NUMBER	NEMA CONFIG. NO.	AMPS	CATALOG NUMBER	NEMA CONFIG. NO.
20	<input type="checkbox"/> L520FI	L5-20P	20	<input type="checkbox"/> L1520FI	L15-20P
20	<input type="checkbox"/> L620FI	L6-20P	20	<input type="checkbox"/> L1620FI	L16-20P
20	<input type="checkbox"/> L720FI	L7-20P	20	<input type="checkbox"/> L1820FI	L18-20P
20	<input type="checkbox"/> L820FI	L8-20P	20	<input type="checkbox"/> L1920FI	L19-20P
20	<input type="checkbox"/> L920FI	L9-20P	20	<input type="checkbox"/> L2020FI	L20-20P
20	<input type="checkbox"/> L1020FI	L10-20P	20	<input type="checkbox"/> L2120FI	L21-20P
20	<input type="checkbox"/> L1120FI	L11-20P	20	<input type="checkbox"/> L2220FI	L22-20P
20	<input type="checkbox"/> L1220FI	L12-20P	20	<input type="checkbox"/> L2220FIBK	L22-20P
20	<input type="checkbox"/> L1420FI	L14-20P	20	<input type="checkbox"/> L2320FI	L23-20P

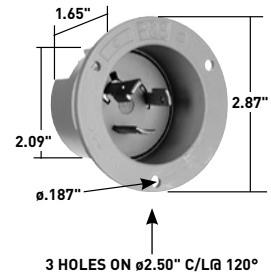

Performance

Electrical

Dielectric Withstand Voltage: 3000V minimum
 Maximum Working Voltage: 600VAC
 Current Interrupting: Certified for current interrupting at full-rated current
 Temperature Rise: 30°C max. after 50 cycles at 150% rated current

Mechanical

Terminal Identification: Green = Ground, White = Neutral, Brass = Hot
 Terminal Accommodation: #12 AWG min. – #8 AWG max.
 Product Identification: Amperage, Voltage, 3rd Party Compliance, NEMA Configuration

Environmental

Flammability: UL94 V2
 Operating Temperature: Maximum continuous +115°C, minimum -40°C without impact

Materials

Flanged Casing: Polycarbonate
 Blade Holder: Polycarbonate
 Blades: Brass
 Terminal Clamp: Zinc-Plated Steel
 Terminal Screws: Zinc- or Brass-Plated Steel
 Ground Screws: Zinc-Plated Steel
 Assembly Screws: Zinc-Plated Steel

Consult Turnlok® Section G for complete compliance listing.

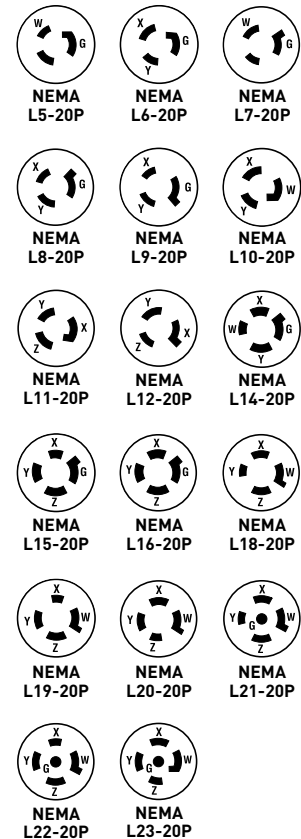

Project
Location/Type

TECHNICAL SPECIFICATIONS

20A Turnlok® Flanged Outlets

Typical Specifications

Manufacturer's Identification: Pass & Seymour® L520FO
 Description: Locking Flanged Outlet, Power Supply
 Type: 2 Pole, 3 Wire Grounding
 Rating: 20A, 125V
 Configuration: NEMA L5-20R
 3rd Party Compliance: UL Listed, File Number E146159, Standard UL498, Attachment Plugs and Receptacles. Federal Specification WC596. CSA Certified, File Number LR1765, Standard CSA-C22.2 No. 42, General Use Receptacles and Attachment Plugs. Conforms to NEMA WD-1 and WD-6.

AMPS	CATALOG NUMBER	NEMA CONFIG. NO.	AMTS	CATALOG NUMBER	NEMA CONFIG. NO.
20	<input type="checkbox"/> L520FO	L5-20R	20	<input type="checkbox"/> L1520FO	L15-20R
20	<input type="checkbox"/> L620FO	L6-20R	20	<input type="checkbox"/> L1620FO	L16-20R
20	<input type="checkbox"/> L720FO	L7-20R	20	<input type="checkbox"/> L1820FO	L18-20R
20	<input type="checkbox"/> L820FO	L8-20R	20	<input type="checkbox"/> L1920FO	L19-20R
20	<input type="checkbox"/> L920FO	L9-20R	20	<input type="checkbox"/> L2020FO	L20-20R
20	<input type="checkbox"/> L1020FO	L10-20R	20	<input type="checkbox"/> L2120FO	L21-20R
20	<input type="checkbox"/> L1120FO	L11-20R	20	<input type="checkbox"/> L2220FO	L22-20R
20	<input type="checkbox"/> L1220FO	L12-20R	20	<input type="checkbox"/> L2220FOBK	L22-20R
20	<input type="checkbox"/> L1420FO	L14-20R	20	<input type="checkbox"/> L2320FO	L23-20R
			20	<input type="checkbox"/> L3720FO	L24-20R

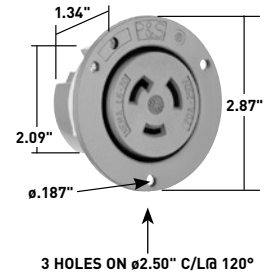

Performance

Electrical

Dielectric Withstand Voltage: 3000V minimum
 Maximum Working Voltage: 600VAC
 Current Interrupting: Certified for current interrupting at full-rated current
 Temperature Rise: 30°C max. after 50 cycles at 150% rated current

Mechanical

Terminal Identification: Green = Ground, White = Neutral, Brass = Hot
 Terminal Accommodation: #12 AWG min. – #8 AWG max.
 Product Identification: Amperage, Voltage, 3rd Party Compliance, NEMA Configuration

Environmental

Flammability: UL94 V2
 Operating Temperature: Maximum continuous +115°C, minimum -40°C without impact

Materials

Flanged Casing: Polycarbonate
 Contact Carrier: Polycarbonate
 Contacts: Brass
 Terminal Clamp: Zinc-Plated Steel
 Terminal Screws: Zinc- or Brass-Plated Steel
 Ground Screws: Zinc-Plated Steel
 Assembly Screws: Zinc-Plated Steel

Consult Turnlok® Section G for complete compliance listing.

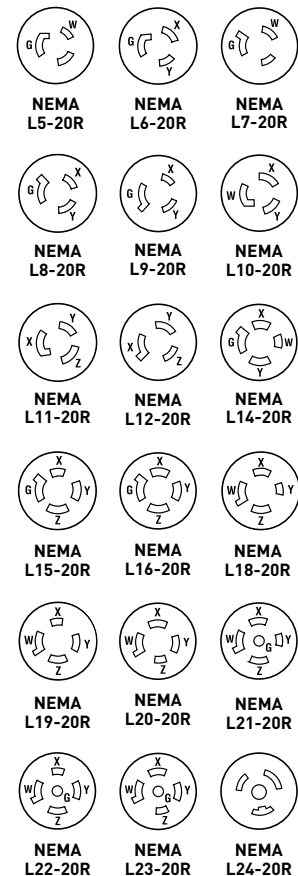

Project
Location/Type

TECHNICAL SPECIFICATIONS

30A Turnlok® Flanged Inlets

Typical Specifications

Manufacturer's Identification: Pass & Seymour® L530FI
 Description: Locking Flanged Inlet, Power Supply
 Type: 2 Pole, 3 Wire Grounding
 Rating: 30A, 125V
 Configuration: NEMA L5-30P
 3rd Party Compliance: UL Listed, File Number E146159, Standard UL498, Attachment Plugs and Receptacles. Federal Specification WC596. CSA Certified, File Number LR1765, Standard CSA-C22.2 No. 42, General Use Receptacles and Attachment Plugs. Conforms to NEMA WD-1 and WD-6.

AMPS	CATALOG NUMBER	NEMA CONFIG. NO.	AMPS	CATALOG NUMBER	NEMA CONFIG. NO.
30	<input type="checkbox"/> L530FI	L5-30P	30	<input type="checkbox"/> L1530FI	L15-30P
30	<input type="checkbox"/> L630FI	L6-30P	30	<input type="checkbox"/> L1530FIBK	L15-30P
30	<input type="checkbox"/> L730FI	L7-30P	30	<input type="checkbox"/> L1630FI	L16-30P
30	<input type="checkbox"/> L830FI	L8-30P	30	<input type="checkbox"/> L1730FI	L17-30P
30	<input type="checkbox"/> L930FI	L9-30P	30	<input type="checkbox"/> L1830FI	L18-30P
30	<input type="checkbox"/> L1030FI	L10-30P	30	<input type="checkbox"/> L1930FI	L19-30P
30	<input type="checkbox"/> L1130FI	L11-30P	30	<input type="checkbox"/> L2030FI	L20-30P
30	<input type="checkbox"/> L1230FI	L12-30P	30	<input type="checkbox"/> L2130FI	L21-30P
30	<input type="checkbox"/> L1430FI	L14-30P	30	<input type="checkbox"/> L2230FI	L22-30P
			30	<input type="checkbox"/> L2230FIBK	L22-30P
			30	<input type="checkbox"/> L2330FI	L23-30P

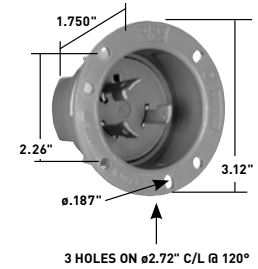

Performance

Electrical

Dielectric Withstand Voltage: 3000V minimum
 Maximum Working Voltage: 600VAC
 Current Interrupting: Certified for current interrupting at full-rated current
 Temperature Rise: 30°C max. after 50 cycles at 150% rated current

Mechanical

Terminal Identification: Green = Ground, White = Neutral, Brass = Hot
 Terminal Accommodation: #12 AWG min. – #8 AWG max.
 Product Identification: Amperage, Voltage, 3rd Party Compliance, NEMA Configuration

Environmental

Flammability: UL94 V2
 Operating Temperature: Maximum continuous +75°C, minimum -40°C without impact

Materials

Flanged Casing: Polycarbonate
 Blade Holder: Nylon
 Blades: Tin-Plated Stresscon
 Terminal Clamp: Brass
 Terminal Screws: Brass
 Ground Screws: Brass
 Assembly Screws: Zinc-Plated Steel

Consult Turnlok® Section H for complete compliance listing.

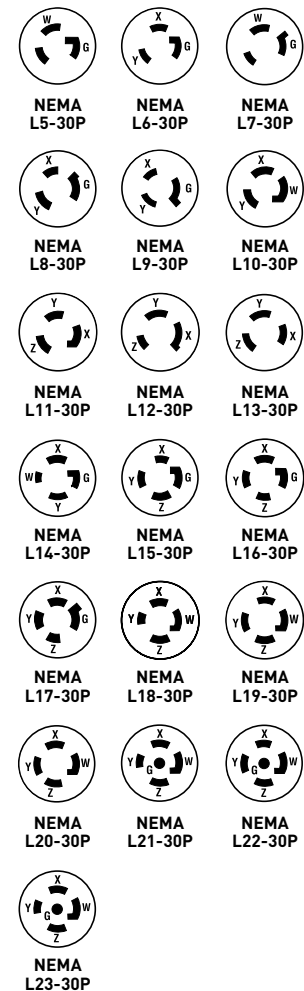

Project
Location/Type

TECHNICAL SPECIFICATIONS

30A Turnlok® Flanged Outlets

Typical Specifications

Manufacturer's Identification: Pass & Seymour® L530FO
 Description: Locking Flanged Outlet, Power Supply
 Type: 2 Pole, 3 Wire Grounding
 Rating: 30A, 125V
 Configuration: NEMA L5-30R
 3rd Party Compliance: UL Listed, File Number E146159, Standard UL498, Attachment Plugs and Receptacles. Federal Specification WC596. CSA Certified, File Number LR1765, Standard CSA-C22.2 No. 42, General Use Receptacles and Attachment Plugs. Conforms to NEMA WD-1 and WD-6.

AMPS	CATALOG NUMBER	NEMA CONFIG. NO.	AMPS	CATALOG NUMBER	NEMA CONFIG. NO.
30	<input type="checkbox"/> L530FO	L5-30R	30	<input type="checkbox"/> L1530FO	L15-30R
30	<input type="checkbox"/> L630FO	L6-30R	30	<input type="checkbox"/> L1530FOBK	L15-30R
30	<input type="checkbox"/> L730FO	L7-30R	30	<input type="checkbox"/> L1630FO	L16-30R
30	<input type="checkbox"/> L830FO	L8-30R	30	<input type="checkbox"/> L1730FO	L17-30R
30	<input type="checkbox"/> L930FO	L9-30R	30	<input type="checkbox"/> L1830FO	L18-30R
30	<input type="checkbox"/> L1030FO	L10-30R	30	<input type="checkbox"/> L1930FO	L19-30R
30	<input type="checkbox"/> L1130FO	L11-30R	30	<input type="checkbox"/> L2030FO	L20-30R
30	<input type="checkbox"/> L1230FO	L12-30R	30	<input type="checkbox"/> L2130FO	L21-30R
30	<input type="checkbox"/> L1330FO	L13-30R	30	<input type="checkbox"/> L2230FO	L22-30R
30	<input type="checkbox"/> L1430FO	L14-30R	30	<input type="checkbox"/> L2230FOBK	L22-30R
			30	<input type="checkbox"/> L2330FO	L23-30R

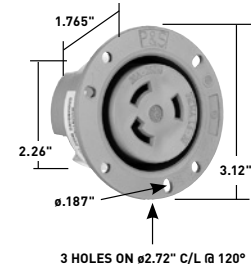

Performance

Electrical

Dielectric Withstand Voltage: 3000V minimum
 Maximum Working Voltage: 600VAC
 Current Interrupting: Certified for current interrupting at full-rated current
 Temperature Rise: 30°C max. after 50 cycles at 150% rated current

Mechanical

Terminal Identification: Green = Ground, White = Neutral, Brass = Hot
 Terminal Accommodation: #12 AWG min. – #8 AWG max.
 Product Identification: Amperage, Voltage, 3rd Party Compliance, NEMA Configuration

Environmental

Flammability: UL94 V2
 Operating Temperature: Maximum continuous +75°C, minimum -40°C without impact

Materials

Flanged Casing: Polycarbonate
 Contact Carrier: Nylon
 Contacts: Tin-Plated Brass
 Terminal Clamp: Brass- or Nickel-Plated Steel
 Terminal Screws: Brass- or Nickel-Plated Steel
 Ground Screws: Nickel-Plated Brass
 Assembly Screws: Zinc-Plated Steel

Consult Turnlok® Section H for complete compliance listing.

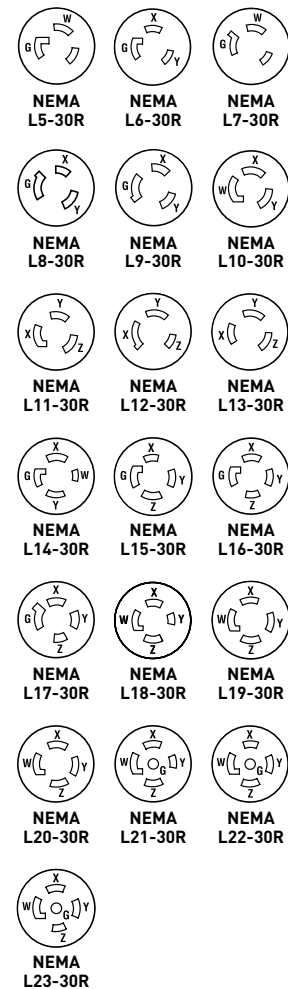

TECHNICAL SPECIFICATIONS

Project
Location/Type

TECHNICAL SPECIFICATIONS

Turnlok® Rubber Dust-Tight Plugs & Connectors

Typical Specifications

Manufacturer's Identification: Pass & Seymour® 2447
 Description: Rubber Dust-Tight Locking Plug, Power Supply
 Type: 2 Pole, 3 Wire Grounding
 Rating: 15A, 125V
 Configuration: NEMA L5-15P
 3rd Party Compliance: UL Listed, Standard UL498, Attachment Plugs and Receptacles.
 Federal Specification WC596. CSA Certified Standard CSA-C22.2 No. 42, General Use Receptacles and Attachment Plugs. Conforms to NEMA WD-1.



2647

2747

AMPS	CATALOG NUMBER	NEMA CONFIG. NO.	AMPS	CATALOG NUMBER	NEMA CONFIG. NO.	AMPS	CATALOG NUMBER	NEMA CONFIG. NO.
15	2447	L5-15P	15	2434	L7-15P	30	2875	L15-30P
15	2547	L5-15R	15	2534	L7-15R	30	2975	L15-30R
20	2647	L5-20P	20	2649	L7-20P	20	2676	L16-20P
20	2747	L5-20R	20	2749	L7-20R	20	2776	L16-20R
30	2847	L5-30P	30	2849	L7-30P	30	2876	L16-30P
30	2947	L5-30R	30	2949	L7-30R	30	2976	L16-30R
15	2449	L6-15P	20	2674	L14-20P	30	2877	L17-30P
15	2549	L6-15R	20	2774	L14-20R	30	2977	L17-30R
20	2648	L6-20P	30	2874	L14-30P	20	2608	NON
20	2748	L6-20R	30	2974	L14-30R	20	2708	NON
30	2848	L6-30P	20	2675	L15-20P			
30	2948	L6-30R	20	2775	L15-20R			

Performance

Electrical

Dielectric Withstand Voltage: 15A = 1600V minimum, 20A & 30A = 2200V minimum
 Maximum Working Voltage: 15A = 277VAC, 20 & 30A = 600VAC
 Current Interrupting: Certified for current interrupting at full-rated current
 Temperature Rise: 30°C maximum after 50 cycles at 150% rated current

Mechanical

Cord Accommodations: Round portable service cords of diameters in accordance with the device rating as defined in UL62
 Terminal Identification: 15A = Green = Ground, White = Neutral, Brass = Hot
 20A & 30A = "GR" and Green color = Ground, "WH" and White color = Neutral, "X", "Y", "Z" = Hot
 Terminal Accommodation: 15A = #18 AWG min. - #10 AWG max.;
 20A = #18 AWG min. - #8 AWG max.
 30A = #18 AWG min. - #6 AWG max.
 Product Identification: Amperage, Voltage, 3rd Party Compliance, NEMA Configuration hot stamped onto device

Environmental

Flammability: UL94 V2
 Operating Temperature: Maximum continuous +75°C, minimum -40°C without impact

Materials

Body: Thermoplastic Elastomer
 Terminal Chamber: Polycarbonate
 Compression Nut: Nylon
 Compression Grommet: Thermoplastic Elastomer
 Dust Cover: Thermoplastic Elastomer
 Plug Blades: Brass
 Connector Contacts: Brass
 Terminal Clamps: Brass
 Terminal Screws Hot: Brass
 Terminal Screws Hot/Neutral: Zinc-Plated Brass
 Ground Screws: Zinc/Green-Plated Brass, Hex-Head
 Assembly Screws: Stainless Steel

Consult Turnlok® Section H for complete compliance listing.

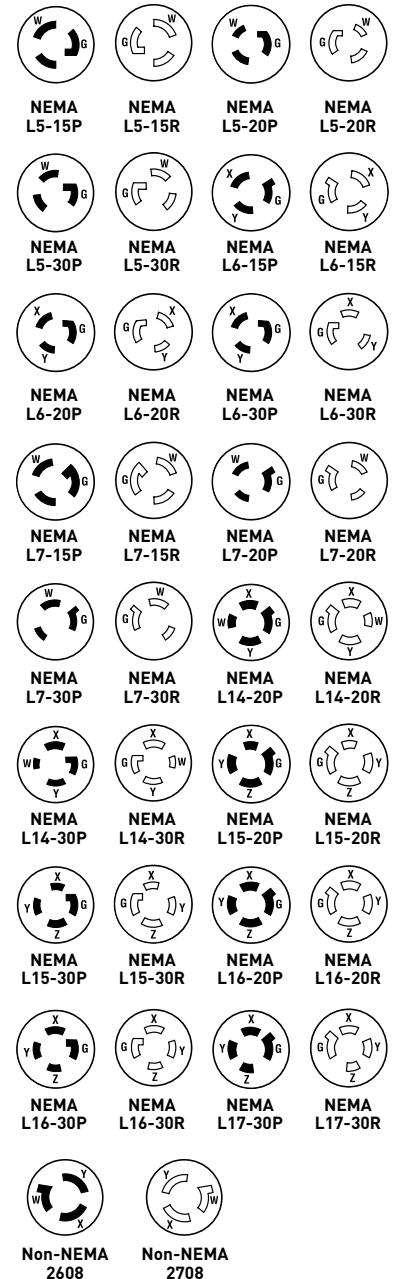

Project
Location/Type

TECHNICAL SPECIFICATIONS

Turnlok® Watertight Plugs, Connectors & Receptacles

Typical Specifications

Manufacturer's Identification: Pass & Seymour® 24W47
 Description: Watertight Locking Plug, Power Supply
 Type: 2 Pole, 3 Wire Grounding
 Rating: 15A, 125V
 Configuration: NEMA L5-15P
 3rd Party Compliance: UL Listed, Standard UL498 (Plug/Connector).
 CSA Certified, Standard CSA C22.2 No. 42. Conforms to NEMA WD-1, WD-6 and ANSI standards.



24W49

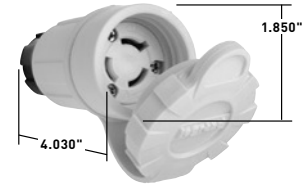

25W49

AMPS	CATALOG NUMBER	NEMA CONFIG. NO.	AMPS	CATALOG NUMBER	NEMA CONFIG. NO.	AMPS	CATALOG NUMBER	NEMA CONFIG. NO.
15	24W47	L5-15P	15	24W49	L6-15P	15	24W34	L7-15P
15	25W47	L5-15R	15	25W49	L6-15R	15	25W34	L7-15R
15	65W47	L5-15R	15	65W49	L6-15R	15	65W34	L7-15R
15	65W47DPLX	L5-15R	15	65W49DPLX	L6-15R	15	65W34DPLX	L7-15R
20	26W47	L5-20P	20	26W48	L6-20P	20	26W49	L7-20P
20	26W47GCM	L5-20R	20	27W48	L6-20R	20	27W49	L7-20R
20	27W47	L5-20R	20	67W48	L6-20R	20	67W49	L7-20R
20	27W47GCM	L5-20R	30	28W48	L6-30P	30	28W49	L7-30P
20	67W47	L5-20R	30	29W48	L6-30R	30	29W49	L7-30R
30	28W47	L5-30P	30	69W48	L6-30R	30	69W49	L7-30R
30	29W47	L5-30R						
30	69W47	L5-30R						

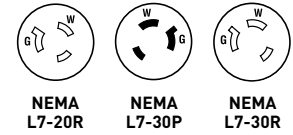
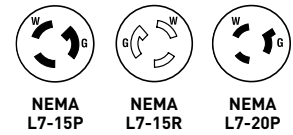
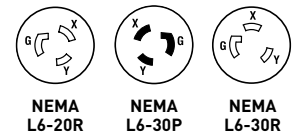
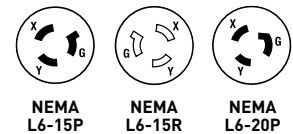
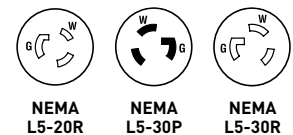
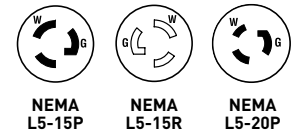

Performance

Electrical

Dielectric Withstand Voltage Connectors: 2000V AC if rated 300V or less
 3000V AC if rated above 300V
 Plugs: 2500V AC if rated 300V or less
 3500V AC if rated above 300V
 Maximum Working Voltage: As marked
 Current Interrupting: Rated for current interruption per UL498
 Temperature Rise: 30°C maximum per UL498 at rated current

Mechanical

Cord & Terminal Accommodations
 Plugs & Connectors

15A & 20A Straight Blade and 15A locking:	Type S, SO, ST, SJ, SJO, SJT, 18/3 to 12/3, .300 min. to .625 in. max [7.6 to 15.9mm] dia.
20A & 30A 3-wire locking:	12/3 SJ, 14/3 S to 10/3 S, (.475" to .720") [12.1mm to 19.2mm]
20A 4-wire locking:	14/4 S to 10/4 S, (.560" to .775") [14.2mm to 19.9mm]
30A 4-wire locking:	12/4 S to 8/4 S, 6/4 MSHA (.640" to .930") [16.3mm to 23.6mm]
All 15A & 20A straight blade:	18 AWG to 12 AWG
20A locking & 30A 3-wire:	14 AWG to 10 AWG
30A 4-wire:	12 AWG to 6 AWG

Environmental

Moisture Resistance: NEMA 4, 4X, 12, 6, 6P (Plug & Connector only)
 Flammability: UL94V0 (boxes & wiring device interiors)
 Operating Temperature: -40°C (without impact) to +60°C continuous
 UV resistance: All exposed materials are UV stabilized

Materials

Body/Contact Carrier:	PBT Thermoplastic, Yellow	Ferrule:	Polypropylene, Natural
Terminal Retainer:	Polycarbonate, Clear	Blades/Contacts:	Brass, Nickel
Housing:	Thermoplastic Elastomer, Yellow	Terminal Screws:	Steel, Chromate
Housing Insert:	Polypropylene, Natural	Terminal Screw Size:	#8-32
Strain Relief Nut:	PBT Thermoplastic, Black	Body Holding Screws:	Stainless Steel
Grommet:	Thermoplastic Elastomer, Various Colors	Drive Screws:	Steel, Chromate

Project
Location/Type

TECHNICAL SPECIFICATIONS

Turnlok® Watertight Plugs, Connectors & Receptacles

Typical Specifications

Manufacturer's Identification: Pass & Seymour® 26W74
 Description: Watertight Locking Plug, Power Supply
 Type: 3 Pole, 4 Wire Grounding 20 & 30A, 125/250
 Rating: 20A, 125/250V
 Configuration: NEMA L14-20P
 3rd Party Compliance: UL Listed, Standard UL498 (Plug/Connector).
 CSA Certified, Standard CSA C22.2 No. 42. Conforms to NEMA WD-1, WD-6 and ANSI standards.

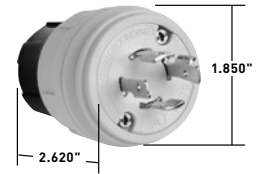

26W74

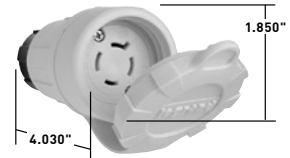

27W74

AMPS	CATALOG NUMBER	NEMA CONFIG. NO.	AMPS	CATALOG NUMBER	NEMA CONFIG. NO.	AMPS	CATALOG NUMBER	NEMA CONFIG. NO.
20	26W74	L14-20P	30	29W75	L15-30R	30	69W77	L17-30R
20	27W74	L14-20R	30	69W75	L15-30R	20	26W08	NON
20	67W74	L14-20R	20	26W76	L16-20P	20	27W08	NON
30	28W74	L14-30P	20	27W76	L16-20R	20	67W08	NON
30	29W74	L14-30R	20	67W76	L16-20R	30	28W08	NON
30	69W74	L14-30R	30	28W76	L16-30P	30	29W08	NON
20	26W75	L15-20P	30	29W76	L16-30R	30	69W08	NON
20	27W75	L15-20R	30	69W76	L16-30R	30	28W09	NON
20	67W75	L15-20R	30	28W77	L17-30P	30	29W09	NON
30	28W75	L15-30P	30	29W77	L17-30R	30	69W09	NON

Performance

Electrical

Dielectric Withstand Voltage Connectors: 2000V AC if rated 300V or less
 3000V AC if rated above 300V
 Plugs: 2500V AC if rated 300V or less
 3500V AC if rated above 300V
 Maximum Working Voltage: As marked
 Current Interrupting: Rated for current interruption per UL498
 Temperature Rise: 30°C maximum per UL498 at rated current

Mechanical

Cord & Terminal Accommodations:

Plugs & Connectors

15A & 20A Straight Blade and 15A locking:	Type S, SO, ST, SJ, SJO, SJT, 18/3 to 12/3, .300 min. to .625 in. max [7.6 to 15.9mm] dia.
20A & 30A 3-wire locking:	12/3 SJ, 14/3 S to 10/3 S, (.475" to .720") [12.1mm to 19.2mm]
20A 4-wire locking:	14/4 S to 10/4 S, (.560" to .775") [14.2mm to 19.9mm]
30A 4-wire locking:	12/4 S to 8/4 S, 6/4 MSHA (.640" to .930") [16.3mm to 23.6mm]
All 15A & 20A straight blade:	18 AWG to 12 AWG
20A locking & 30A 3-wire:	14 AWG to 10 AWG
30A 4-wire:	12 AWG to 6 AWG

Environmental

Moisture Resistance: NEMA 4, 4X, 12, 6, 6P (Plug & Connector only)
 Flammability: UL94V0 (boxes & wiring device interiors)
 Operating Temperature: -40°C [without impact] to +60°C continuous
 UV resistance: All exposed materials are UV stabilized

Materials

Body/Contact Carrier:	PBT Thermoplastic, Yellow	Ferrule:	Polypropylene, Natural
Terminal Retainer:	Polycarbonate, Clear	Blades/Contacts:	Brass, Nickel
Housing:	Thermoplastic Elastomer, Yellow	Terminal Screws:	Steel, Chromate
		Terminal Screw Size:	#8-32
Housing Insert:	Polypropylene, Natural	Body Holding Screws:	Stainless Steel
Strain Relief Nut:	PBT Thermoplastic, Black	Drive Screws:	Steel, Chromate
Grommet:	Thermoplastic Elastomer, Various Colors		

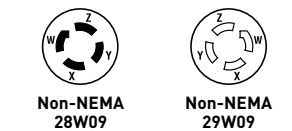
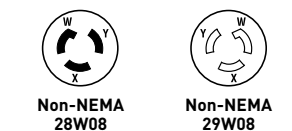
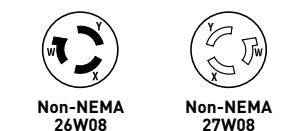
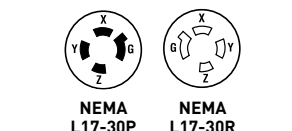
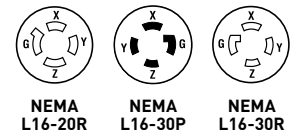
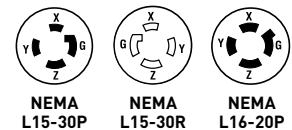
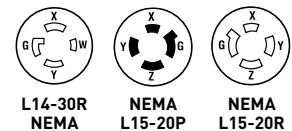
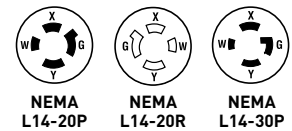

Project
Location/Type

TECHNICAL SPECIFICATIONS

TECHNICAL SPECIFICATIONS

California Standard & Corrosion-Resistant

Typical Specifications

Manufacturer's Identification: Pass & Seymour® CS6370
 Description: California Standard Locking Receptacle
 Type: 3 Wire Grounding
 Rating: 50A, 125V
 Configuration: Non-NEMA
 3rd Party Compliance: UL Listed, Standard UL498. Federal Specification WC596.
 CSA Certified, Standard CSA. Conforms to NEMA WD-1 and WD-6.

CATALOG NUMBER	RATING	
	A.	V.
RECEPTACLES		
<input type="checkbox"/> CR6370	50	125
<input type="checkbox"/> CS6370	50	125
<input type="checkbox"/> CS8269	50	250
<input type="checkbox"/> CS8469	50	480
<input type="checkbox"/> 3771	50	250VDC, 600VAC
CONNECTORS IP20 SUITABILITY		
<input type="checkbox"/> CR6360	50	125
<input type="checkbox"/> CS6360	50	125
<input type="checkbox"/> CS8264	50	250
<input type="checkbox"/> CS8464	50	480
<input type="checkbox"/> 3762	50	250VDC, 600VAC

CATALOG NUMBER	RATING*	
	A.	V.
PLUGS IP20 SUITABILITY		
<input type="checkbox"/> CR6361	50	125
<input type="checkbox"/> CS6361	50	125
<input type="checkbox"/> CS8265	50	250
<input type="checkbox"/> CS8465	50	480
<input type="checkbox"/> 3763M	50	250VDC, 600VAC
FLANGED INLETS & OUTLETS		
<input type="checkbox"/> CS6377	50	125
<input type="checkbox"/> CS8275	50	250
<input type="checkbox"/> CS8475	50 </td <td>480</td>	480
<input type="checkbox"/> 3777	50	250VDC, 600VAC

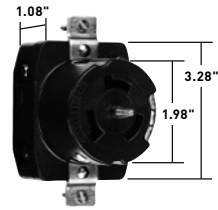

California Standard Receptacle

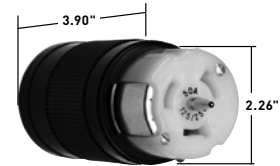

California Standard Connector

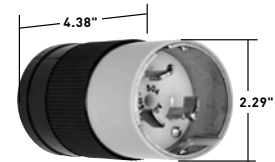

California Standard Plug

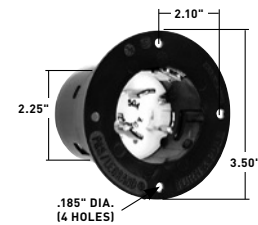

Corrosion-Resistant Flanged Inlet

Performance

Electrical

Dielectric Withstand Voltage: 3000V minimum
 Maximum Working Voltage: 600VAC
 Current Interrupting: Certified for current interrupting at full-rated current
 Temperature Rise: 30°C maximum after 50 cycles at 150% rated current

Mechanical

Cord Accommodations: Round portable service cords of diameters in accordance with the device rating as defined in UL62
 Cord Grip Accommodations: .680"–1.125" diameter
 Terminal Identification: Color Coded Terminal Screws
 Terminal Accommodation: #10 AWG min. – #4 AWG max.
 Product Identification: Amperage, Voltage hot stamped on device

Environmental

Flammability: UL94 HB or better
 Operating Temperature: Maximum continuous: +75°C, Minimum: -40°C without impact

Materials

PLUGS	Corrosion-Resistant	California Standard	CONNECTORS	Corrosion-Resistant	California Standard
Plug Shroud:	Zytel Super Tough Nylon	Zytel Super Tough Nylon	Back Body:	Nylon	Nylon
Back Body:	Nylon	Nylon	Front Body:	Nylon	Nylon
Front Body:	Nylon	Nylon	Terminal Chamber:	Nylon	Nylon
Terminal Chamber:	Nylon	Nylon	Cord Clamp:	Nylon	Nylon
Cord Clamp:	Nylon	Nylon	Contacts:	Nickel-Plated Brass	Brass
Blades:	Nickel-Plated Brass	Brass	Terminal Clamp:	Nickel-Plated Brass	Brass
Terminal Clamp:	Nickel-Plated Brass	Brass	Terminal Screws:	Nickel-Plated Brass	Brass
Terminal Screws:	Nickel-Plated Brass	Brass	Ground Screw:	Nickel-Plated Brass	Brass
Ground Screw:	Nickel-Plated Brass	Brass	Assembly Screws:	Stainless Steel	Stainless Steel
Assembly Screws:	Stainless Steel	Stainless Steel			

INLETS

Flanged Casing: Nylon
 Contact Carrier: Nylon
 Blades: Brass
 Terminal Clamps: Brass
 Terminal Screws: Brass
 Assembly Screws: Nickel-Plated Steel

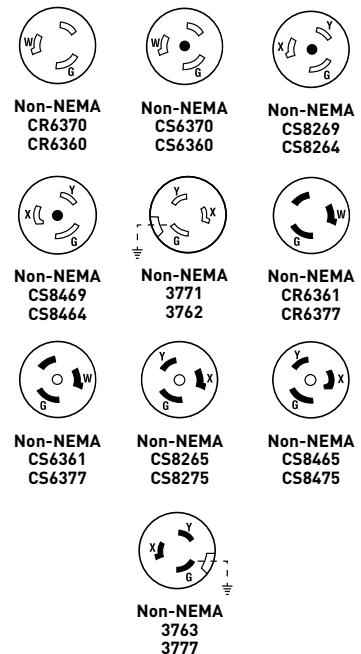

TECHNICAL SPECIFICATIONS

Project
Location/Type

TECHNICAL SPECIFICATIONS

California Standard & Corrosion-Resistant

Typical Specifications

Manufacturer's Identification: Pass & Seymour® CR6369
 Description: Corrosion-Resistant Locking Receptacle
 Type: 4 Wire Grounding
 Rating: 50A, 125V/250V
 Configuration: Non-NEMA
 3rd Party Compliance: UL Listed, Standard UL498. Federal Specification WC596.
 CSA Certified, Standard CSA. Conforms to NEMA WD-1 and WD-6.

CATALOG NUMBER	RATING		CATALOG NUMBER	RATING*	
	A.	V.		A.	V.
RECEPTACLES					
☐ CR6369	50	125/250	☐ CR6365	50	125/250
☐ CS6369	50	125/250	☐ CS6365	50	125/250
☐ CS8369	50	3ø, 250	☐ CS8365	50	3ø, 250
☐ CS8169	50	3ø, 480	☐ CS8165	50	3ø, 480
☐ 3769	50	250VDC, 600VAC	☐ 3765	50	250VDC, 600VAC
☐ 7379*	50	250VDC, 600VAC	☐ 7765*	50	250VDC, 600VAC
CONNECTORS					
☐ CR6364	50	125/250	☐ CR6375	50	125/250
☐ CS6364	50	125/250	☐ CS6375	50	125/250
☐ CS8364	50	3ø, 250	☐ CS8375	50	3ø, 250
☐ CS8164	50	3ø, 480	☐ CS8175	50	3ø, 480
☐ 3764	50	250VDC, 600VAC	☐ CS8177	50	3ø, 480
☐ 7764*	50	250VDC, 600VAC	☐ 3775	50	250VDC, 600VAC
			☐ 7958P*	50	250VDC, 600VAC
PLUGS					
FLANGED INLETS					

*Devices for replacement use only in existing installations.

Performance

Electrical

Dielectric Withstand Voltage: 3000V minimum
 Maximum Working Voltage: 600VAC
 Current Interrupting: Certified for current interrupting at full-rated current
 Temperature Rise: 30°C maximum after 50 cycles at 150% rated current

Mechanical

Cord Accommodations: Round portable service cords of diameters in accordance with the device rating as defined in UL62
 Cord Grip Accommodations: .680"–1.125" diameter
 Terminal Identification: Color Coded Terminal Screws
 Terminal Accommodation: #10 AWG min. – #4 AWG max.
 Product Identification: Amperage, Voltage hot stamped on device

Environmental

Flammability: UL94 HB or better
 Operating Temperature: Maximum continuous: +75°C, Minimum: -40°C without impact

Materials

PLUGS	Corrosion-Resistant	California Standard	CONNECTORS	Corrosion-Resistant	California Standard
Plug Shroud:	Zytel Super Tough Nylon	Zytel Super Tough Nylon	Back Body:	Nylon	Nylon
Back Body:	Nylon	Nylon	Front Body:	Nylon	Nylon
Front Body:	Nylon	Nylon	Terminal Chamber:	Nylon	Nylon
Terminal Chamber:	Nylon	Nylon	Cord Clamp:	Nylon	Nylon
Cord Clamp:	Nylon	Nylon	Contacts:	Nickel-Plated Brass	Brass
Blades:	Nickel-Plated Brass	Brass	Terminal Clamp:	Nickel-Plated Brass	Brass
Terminal Clamp:	Nickel-Plated Brass	Brass	Terminal Screws:	Nickel-Plated Brass	Brass
Terminal Screws:	Nickel-Plated Brass	Brass	Ground Screw:	Nickel-Plated Brass	Brass
Ground Screw:	Nickel-Plated Brass	Brass	Assembly Screws:	Stainless Steel	Stainless Steel
Assembly Screws:	Stainless Steel	Stainless Steel			

INLETS

Flanged Casing:	Nylon	Blades:	Brass	Terminal Screws:	Brass
Contact Carrier:	Nylon	Terminal Clamps:	Brass	Assembly Screws:	Nickel-Plated Steel

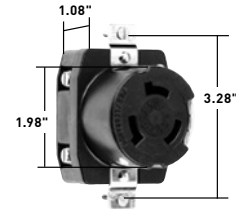

Corrosion-Resistant Receptacle



Corrosion-Resistant Connector

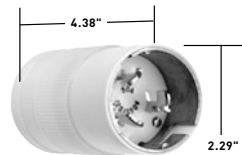

Corrosion-Resistant Plug

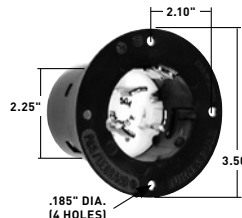

Corrosion-Resistant Flanged Inlet

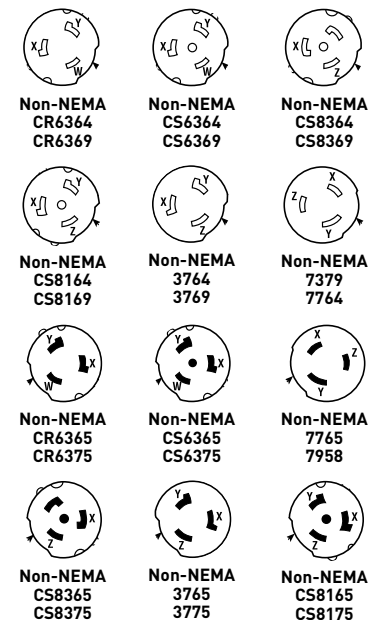

Project
Location/Type

TECHNICAL SPECIFICATIONS

Power Interrupting Devices

Typical Specifications

Manufacturer's Identification: Pass & Seymour® 23000HG
 Description: Power Interrupting Hospital Grade Receptacle
 Type: 2 Pole, 3 Wire
 Rating: 20A, 125V Hospital Use
 3rd Party Compliance: UL Listed, Standard UL498. Conforms to NEMA WD-1 AND WD-6.

Hospital Grade Power Interrupting Devices

CATALOG NUMBER	RATING*	
	A.	V.
<input type="checkbox"/> 23000HG	20	125
<input type="checkbox"/> 23050	20	125
<input type="checkbox"/> 23054N	20	125
<input type="checkbox"/> 23056N	20	125

3-Pole, 4-Wire

CATALOG NUMBER	RATING	
	A.	V.
<input type="checkbox"/> 20443N	30	480
<input type="checkbox"/> 20403N	30	600VAC
	20	250VDC
<input type="checkbox"/> 21420	30	600VAC
	20	250VDC
<input type="checkbox"/> 26420	60	600
<input type="checkbox"/> 20444N	30	480
<input type="checkbox"/> 20414	30	600VAC
	20	250VDC
<input type="checkbox"/> 20414N	30	600VAC
	20	250VDC
<input type="checkbox"/> 21414	30	600VAC
	20	250VDC
<input type="checkbox"/> 26414	60	600
<input type="checkbox"/> 26427	60	600
<input type="checkbox"/> 20445N	30	480
<input type="checkbox"/> 20415	30	600VAC
	20	250VDC
<input type="checkbox"/> 20415N	30	600VAC
	20	250VDC
<input type="checkbox"/> 21415	30	600VAC
	20	250VDC
<input type="checkbox"/> 21426	30	600VAC
	20	250VDC
<input type="checkbox"/> 21426S	30	600VAC
	20	250VDC
<input type="checkbox"/> 26415	60	600
<input type="checkbox"/> 26426	60	600
<input type="checkbox"/> 20418	30	600VAC
	20	250VDC
<input type="checkbox"/> 26415A	60	600

2-Pole, 3-Wire

CATALOG NUMBER	RATING*	
	A.	V.
<input type="checkbox"/> 23000G	20	125
	10	250VDC, 480VAC
<input type="checkbox"/> 23000	2010	125
		250VDC, 480VAC
<input type="checkbox"/> 23002N	20	125
	10	250VDC, 480VAC
<input type="checkbox"/> 23035N	20	125
<input type="checkbox"/> 23005N	20	125
	10	250VDC, 480VAC

4-Pole, 5-Wire

CATALOG NUMBER	RATING	
	A.	V.
<input type="checkbox"/> 25250	30	600VAC
	20	250VDC
<input type="checkbox"/> 26520	60	600
<input type="checkbox"/> 25414N	30	600VAC
	20	250VDC
<input type="checkbox"/> 25414	30	600VAC
	20	250VDC
<input type="checkbox"/> 26514	60	600
<input type="checkbox"/> 26527	60	600
<input type="checkbox"/> 25415N	30	600VAC
	20	250VDC
<input type="checkbox"/> 25415	30	600VAC
	20	250VDC
<input type="checkbox"/> 26515	60	600
<input type="checkbox"/> 26526	60	600
<input type="checkbox"/> 26515A	60	600
<input type="checkbox"/> 26514A	60	600

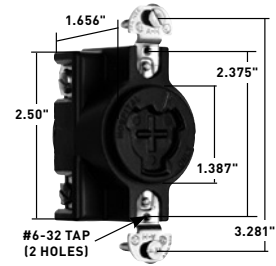

23000HG

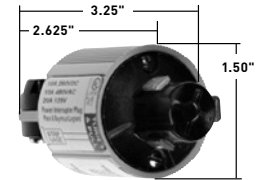

23005N

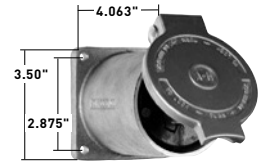

26420

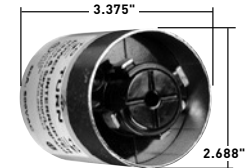

26415

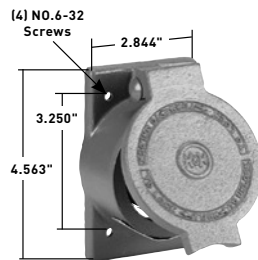

25250

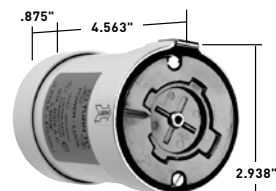

26527

TECHNICAL SPECIFICATIONS

Project
Location/Type

TECHNICAL SPECIFICATIONS

Cam-Type Devices 45° Angled Receptacles

Typical Specifications

Manufacturer's Identification: Pass & Seymour® PS45MRBBK, PS45FRBBK

Description: 45° Angled Receptacles

Type: Single Pole

Electrical Rating: 400A, 600V

Enclosure Rating: NEMA 3R

3rd Party Compliance: UL Listed, File Number E111198, cCSAus Certified, File Number LR81290.

Applicable standards: UL50, Enclosures for Electrical Equipment, UL498, Attachment Plugs and Receptacles, UL1682, Plugs, Receptacles and Cable Connectors of the Pin & Sleeve Type, CSA-C22.2 No. 65-93, Wire Connectors, CSA-C22.2 No. 94-M91, Special Purpose Enclosures, CSA-C22.2 No. 182.1-1988, Industrial Type, Special Use Attachment Plugs, Receptacles. Conforms to NEMA WD-1 and WD-6.

CATALOG NUMBER	RATING*		CABLE SIZE	COLOR	CATALOG NUMBER	RATING*		CABLE SIZE	COLOR
	A.	V.				A.	V.		
<input type="checkbox"/> PS45MRSBBK	400	600	#2 - 4/0	Black	<input type="checkbox"/> PS45FR2SBBK	400	600	#2 - 4/0	Black
<input type="checkbox"/> PS45MRSBW	400	600	#2 - 4/0	White	<input type="checkbox"/> PS45FR2SBW	400	600	#2 - 4/0	White
<input type="checkbox"/> PS45MRSBR	400	600	#2 - 4/0	Red	<input type="checkbox"/> PS45FR2SBR	400	600	#2 - 4/0	Red
<input type="checkbox"/> PS45MRSBBL	400	600	#2 - 4/0	Blue	<input type="checkbox"/> PS45FR2SBBL	400	600	#2 - 4/0	Blue
<input type="checkbox"/> PS45MRSBG	400	600	#2 - 4/0	Green	<input type="checkbox"/> PS45FR2SBG	400	600	#2 - 4/0	Green
<input type="checkbox"/> PS45MR2SBBK	400	600	#2 - 4/0	Black	<input type="checkbox"/> PS45MRBBK	400	600	2/0 - 4/0	Black
<input type="checkbox"/> PS45MR2SBW	400	600	#2 - 4/0	White	<input type="checkbox"/> PS45MRBW	400	600	2/0 - 4/0	White
<input type="checkbox"/> PS45MR2SBR	400	600	#2 - 4/0	Red	<input type="checkbox"/> PS45MRBR	400	600	2/0 - 4/0	Red
<input type="checkbox"/> PS45MR2SBBL	400	600	#2 - 4/0	Blue	<input type="checkbox"/> PS45MRBBL	400	600	2/0 - 4/0	Blue
<input type="checkbox"/> PS45MR2SBG	400	600	#2 - 4/0	Green	<input type="checkbox"/> PS45MRBG	400	600	2/0 - 4/0	Green
<input type="checkbox"/> PS45FRSBBK	400	600	#2 - 4/0	Black	<input type="checkbox"/> PS45FRBBK	400	600	2/0 - 4/0	Black
<input type="checkbox"/> PS45FRSBW	400	600	#2 - 4/0	White	<input type="checkbox"/> PS45FRBW	400	600	2/0 - 4/0	White
<input type="checkbox"/> PS45FRSBR	400	600	#2 - 4/0	Red	<input type="checkbox"/> PS45FRBR	400	600	2/0 - 4/0	Red
<input type="checkbox"/> PS45FRSBBL	400	600	#2 - 4/0	Blue	<input type="checkbox"/> PS45FRBBL	400	600	2/0 - 4/0	Blue
<input type="checkbox"/> PS45FRSBG	400	600	#2 - 4/0	Green	<input type="checkbox"/> PS45FRBG	400	600	2/0 - 4/0	Green



PS45MRBBK



PS45FRBBK

Performance

Electrical

Dielectric Withstand Voltage: 2200V minimum

Maximum Working Voltage: 600VAC

Current Interrupting: Not for interrupting current

Temperature Rise: 45°C maximum

Mechanical

Cord Accommodation: Individual conductor, Type SC, SCE, SCT or W, 75°C, copper wire only

Terminal Accommodation: #2 AWG min. - 4/0 AWG max. - Threaded Type
2/0 AWG min. - 4/0 AWG max. - Set Screw Type

Product Identification: Amperage, Voltage, 3rd Party Compliance, NEMA Standards molded into external product body

Environmental

Flammability: UL94V2

Operating Temperature: Maximum continuous +75°C, minimum -40°C without impact

Enclosure: NEMA Type 3R and 4

Materials

Body - Panel Mounts: Santoprene Thermoplastic Vulcanized

Terminal / Pin / Cam: Brass

Terminal Screw: Plated Steel

Eyelets: Brass

Project
Location/Type

TECHNICAL SPECIFICATIONS

Cam-Type Devices Series 16 In-Line Connectors

Typical Specifications

Manufacturer's Identification: Pass & Seymour® PS40MBBK, PS40FBBK
 Description: Series 16 Single Pole In-Line Connector
 Type: Single Pole
 Electrical Rating: 400A, 600V
 Enclosure Rating: NEMA 3R, 4
 3rd Party Compliance: UL Listed, File Number E111198, cCSAus Certified, File Number LR81290.
 Applicable standards: UL50, Enclosures for Electrical Equipment, UL498, Attachment Plugs and Receptacles, UL1682, Plugs, Receptacles and Cable Connectors of the Pin & Sleeve Type, CSA-C22.2 No. 65-93, Wire Connectors, CSA-C22.2 No. 94-M91, Special Purpose Enclosures, CSA-C22.2 No. 182.1-1988, Industrial Type, Special Use Attachment Plugs, Receptacles. Conforms to NEMA WD-1 and WD-6.

CATALOG NUMBER	RATING*	CABLE SIZE	COLOR	CATALOG NUMBER	RATING*	CABLE SIZE	COLOR
<input type="checkbox"/> PS20MBBK	400 600	#2 - 2/0	Black	<input type="checkbox"/> PS20FBBK	400 600	#2 - 2/0	Black
<input type="checkbox"/> PS20MBW	400 600	#2 - 2/0	White	<input type="checkbox"/> PS20FBW	400 600	#2 - 2/0	White
<input type="checkbox"/> PS20MBR	400 600	#2 - 2/0	Red	<input type="checkbox"/> PS20FBR	400 600	#2 - 2/0	Red
<input type="checkbox"/> PS20MBBL	400 600	#2 - 2/0	Blue	<input type="checkbox"/> PS20FBBL	400 600	#2 - 2/0	Blue
<input type="checkbox"/> PS20MBG	400 600	#2 - 2/0	Green	<input type="checkbox"/> PS20FBG	400 600	#2 - 2/0	Green
<input type="checkbox"/> PS20MBBR	400 600	#2 - 2/0	Brown	<input type="checkbox"/> PS20FBBR	400 600	#2 - 2/0	Brown
<input type="checkbox"/> PS20MBO	400 600	#2 - 2/0	Orange	<input type="checkbox"/> PS20FBO	400 600	#2 - 2/0	Orange
<input type="checkbox"/> PS20MBY	400 600	#2 - 2/0	Yellow	<input type="checkbox"/> PS20FBY	400 600	#2 - 2/0	Yellow
<input type="checkbox"/> PS40MBBK	400 600	2/0 - 4/0	Black	<input type="checkbox"/> PS40FBBK	400 600	2/0 - 4/0	Black
<input type="checkbox"/> PS40MBW	400 600	2/0 - 4/0	White	<input type="checkbox"/> PS40FBW	400 600	2/0 - 4/0	White
<input type="checkbox"/> PS40MBR	400 600	2/0 - 4/0	Red	<input type="checkbox"/> PS40FBR	400 600	2/0 - 4/0	Red
<input type="checkbox"/> PS40MBBL	400 600	2/0 - 4/0	Blue	<input type="checkbox"/> PS40FBBL	400 600	2/0 - 4/0	Blue
<input type="checkbox"/> PS40MBG	400 600	2/0 - 4/0	Green	<input type="checkbox"/> PS40FBG	400 600	2/0 - 4/0	Green
<input type="checkbox"/> PS40MBBR	400 600	2/0 - 4/0	Brown	<input type="checkbox"/> PS40FBBR	400 600	2/0 - 4/0	Brown
<input type="checkbox"/> PS40MBO	400 600	2/0 - 4/0	Orange	<input type="checkbox"/> PS40FBO	400 600	2/0 - 4/0	Orange
<input type="checkbox"/> PS40MBY	400 600	2/0 - 4/0	Yellow	<input type="checkbox"/> PS40FBY	400 600	2/0 - 4/0	Yellow



*All ratings are both AC/DC.

Performance

Electrical

Dielectric Withstand Voltage: 2200V minimum
 Maximum Working Voltage: 600VAC
 Current Interrupting: Not for interrupting current
 Temperature Rise: 45°C maximum

Mechanical

Cord Accommodation: Individual conductor, Type SC, SCE, SCT or W, 75°C, copper wire only
 Terminal Accommodation: PS20 Series = #2 AWG min. - 2/0 AWG max.
 PS40 Series = 2/0 AWG min. - 4/0 AWG max.
 Product Identification: Amperage, Voltage, 3rd Party Compliance, NEMA Standards molded into external product body

Environmental

Flammability: UL94V2
 Operating Temperature: Maximum continuous +75°C, minimum -40°C without impact
 Enclosure: NEMA Type 3R and 4

Materials

Body - Connectors: Thermoplastic Elastomer
 Body - Panel Mounts: Nylon
 Body - Adapters: Thermoplastic Elastomer
 Terminal / Pin / Cam: Brass
 Terminal Screw: Plated Steel
 Retaining Screw: Plastic
 Strain Relief Wire: Copper
 Shim: Copper

TECHNICAL SPECIFICATIONS

Project
Location/Type

TECHNICAL SPECIFICATIONS

Cam-Type Devices Series 15 In-Line Connectors

Typical Specifications

Manufacturer's Identification: Pass & Seymour® PSM2MBK, PSM2FBK

Description: Series 15 Single Pole In-Line Connector

Type: Single Pole

Electrical Rating: 150A, 600V

Enclosure Rating: NEMA 3R, 4

3rd Party Compliance: UL Listed, File Number E111198, cCSAus Certified, File Number LR81290. Applicable standards: UL50, Enclosures for Electrical Equipment, UL498, Attachment Plugs and Receptacles, UL1682, Plugs, Receptacles and Cable Connectors of the Pin & Sleeve Type, CSA-C22.2 No. 65-93, Wire Connectors, CSA-C22.2 No. 94-M91, Special Purpose Enclosures, CSA-C22.2 No. 182.1-1988, Industrial Type, Special Use Attachment Plugs, Receptacles. Conforms to NEMA WD-1 and WD-6.

CATALOG NUMBER	RATING*	CABLE SIZE	COLOR	CATALOG NUMBER	RATING*	CABLE SIZE	COLOR
<input type="checkbox"/> PSM2MBK	150 600	#8 - #2	Black	<input type="checkbox"/> PSM2FBK	150 600	#8 - #2	Black
<input type="checkbox"/> PSM2MW	150 600	#8 - #2	White	<input type="checkbox"/> PSM2FW	150 600	#8 - #2	White
<input type="checkbox"/> PSM2MR	150 600	#8 - #2	Red	<input type="checkbox"/> PSM2FR	150 600	#8 - #2	Red
<input type="checkbox"/> PSM2MBL	150 600	#8 - #2	Blue	<input type="checkbox"/> PSM2FBL	150 600	#8 - #2	Blue
<input type="checkbox"/> PSM2MG	150 600	#8 - #2	Green	<input type="checkbox"/> PSM2FG	150 600	#8 - #2	Green



Performance

Electrical

Dielectric Withstand Voltage: 2200V minimum

Maximum Working Voltage: 600VAC

Current Interrupting: Not for interrupting current

Temperature Rise: 45°C maximum

Mechanical

Cord Accommodation: Individual conductor, Type SC, SCE, SCT or W, 75°C, copper wire only

Terminal Accommodation: PSM Series = #8 AWG min. - #2 AWG max.

Product Identification: Amperage, Voltage, 3rd Party Compliance, NEMA Standards molded into external product body

Environmental

Flammability: UL94V2

Operating Temperature: Maximum continuous +75°C, minimum -40°C without impact

Enclosure: NEMA Type 3R and 4

Materials

Body - Connectors: Thermoplastic Elastomer

Body - Panel Mounts: Nylon

Body - Adapters: Thermoplastic Elastomer

Terminal / Pin / Cam: Brass

Terminal Screw: Plated Steel

Retaining Screw: Plastic

Strain Relief Wire: Copper

Shim: Copper

Project
Location/Type

TECHNICAL SPECIFICATIONS

Cam-Type Devices Series 18 In-Line Connectors

Typical Specifications

Manufacturer's Identification: Pass & Seymour® PLS182MBK, PLS182FBK

Description: Series 18 Single Pole In-Line Connector

Type: Single Pole

Electrical Rating: 400A, 600V

Enclosure Rating: NEMA 3R, 4

3rd Party Compliance: UL Listed, File Number E111198, cCSAus Certified, File Number LR81290. Applicable standards: UL50, Enclosures for Electrical Equipment, UL498, Attachment Plugs and Receptacles, UL1682, Plugs, Receptacles and Cable Connectors of the Pin & Sleeve Type, CSA-C22.2 No. 65-93, Wire Connectors, CSA-C22.2 No. 94-M91, Special Purpose Enclosures, CSA-C22.2 No. 182.1-1988, Industrial Type, Special Use Attachment Plugs, Receptacles. Conforms to NEMA WD-1 and WD-6.

CATALOG NUMBER	RATING*	CABLE SIZE	COLOR	CATALOG NUMBER	RATING*	CABLE SIZE	COLOR
<input type="checkbox"/> PLS182MBK	400 600	#6 - #2	Black	<input type="checkbox"/> PLS182FBK	400 600	#6 - #2	Black
<input type="checkbox"/> PLS182MW	400 600	#6 - #2	White	<input type="checkbox"/> PLS182FW	400 600	#6 - #2	White
<input type="checkbox"/> PLS182MR	400 600	#6 - #2	Red	<input type="checkbox"/> PLS182FR	400 600	#6 - #2	Red
<input type="checkbox"/> PLS182MBL	400 600	#6 - #2	Blue	<input type="checkbox"/> PLS182FBL	400 600	#6 - #2	Blue
<input type="checkbox"/> PLS182MG	400 600	#6 - #2	Green	<input type="checkbox"/> PLS182FG	400 600	#6 - #2	Green
<input type="checkbox"/> PLS1820MBK	400 600	#2 - 2/0	Black	<input type="checkbox"/> PLS1820FBK	400 600	#2 - 2/0	Black
<input type="checkbox"/> PLS1820MW	400 600	#2 - 2/0	White	<input type="checkbox"/> PLS1820FW	400 600	#2 - 2/0	White
<input type="checkbox"/> PLS1820MR	400 600	#2 - 2/0	Red	<input type="checkbox"/> PLS1820FR	400 600	#2 - 2/0	Red
<input type="checkbox"/> PLS1820MBL	400 600	#2 - 2/0	Blue	<input type="checkbox"/> PLS1820FBL	400 600	#2 - 2/0	Blue
<input type="checkbox"/> PLS1820MG	400 600	#2 - 2/0	Green	<input type="checkbox"/> PLS1820FG	400 600	#2 - 2/0	Green
<input type="checkbox"/> PLS1840MBK	400 600	4/0	Black	<input type="checkbox"/> PLS1840FBK	400 600	4/0	Black
<input type="checkbox"/> PLS1840MBL	400 600	4/0	Blue	<input type="checkbox"/> PLS1840FBL	400 600	4/0	Blue



*All ratings are both AC/DC.

Performance

Electrical

Dielectric Withstand Voltage: 2200V minimum

Maximum Working Voltage: 600VAC

Current Interrupting: Not for interrupting current

Temperature Rise: 45°C maximum

Mechanical

Cord Accommodation: Individual conductor, Type SC, SCE, SCT or W, 75°C, copper wire only

Terminal Accommodation: PLS182 Series = #6 AWG min. - #2 AWG max.
 PLS1820 Series = #2 AWG min. - 2/0 AWG max.
 PLS1840 Series = 2/0 AWG min. - 4/0 AWG max.

Product Identification: Amperage, Voltage, 3rd Party Compliance, NEMA Standards molded into external product body

Environmental

Flammability: UL94V2

Operating Temperature: Maximum continuous +75°C, minimum -40°C without impact

Enclosure: NEMA Type 3R and 4

Materials

Body - Connectors: Thermoplastic Elastomer

Body - Panel Mounts: Nylon

Body - Adapters: Thermoplastic Elastomer

Terminal / Pin / Cam: Brass

Terminal Screw: Plated Steel

Retaining Screw: Plastic

Strain Relief Wire: Copper

Shim: Copper

Project
Location/Type

TECHNICAL SPECIFICATIONS

Configuration & Clocking System

Adapting To Worldwide Configuration Standards

Application

Legrand's Pass & Seymour® Pin & Sleeve products are designed to meet IEC 309-1, 309-2 specifications. These specifications are recognized around the world and are intended to prevent the mating of plugs and receptacles of different voltage and current ratings (see Section 406.3(F) of the National Electrical Code® relating to this noninterchangeability feature).

Global Product Offering

Legrand provides IEC 309-1, 309-2 Pass & Seymour® Pin & Sleeve products in both Series I (International) and Series II (North American) current ratings:

Series I (International)	16, 32, 63, 125 Amps
Series II (North American)	20, 30, 60, 100 Amps

North American Catalog Numbering System

Catalog numbers within the North American product offering are structured to communicate the following: manufacturer, number of conductors, amperage rating, device type, clocking position of the ground sleeve, and environmental rating. This applies to all receptacles, inlets, plugs, and connectors in the Pass & Seymour® North American Pin & Sleeve product line (see sample below).

Here's How It Works

The amperage rating is determined by the size of the device. Voltage rating is determined by the location of the ground sleeve on the receptacle and/or connector along with the number of conductors.

Ground sleeve position for all connectors and receptacles is based on a clock face with the keyway always being at 6 o'clock. The ground sleeve is positioned at a specific hour point, depending on the device's voltage rating.

The clocking position for plugs and inlets is a mirror image of the mating device, allowing for interconnection.

In addition, voltage ratings for all Pin & Sleeve products are color coded for visual identification.

IEC 309 Clocking System

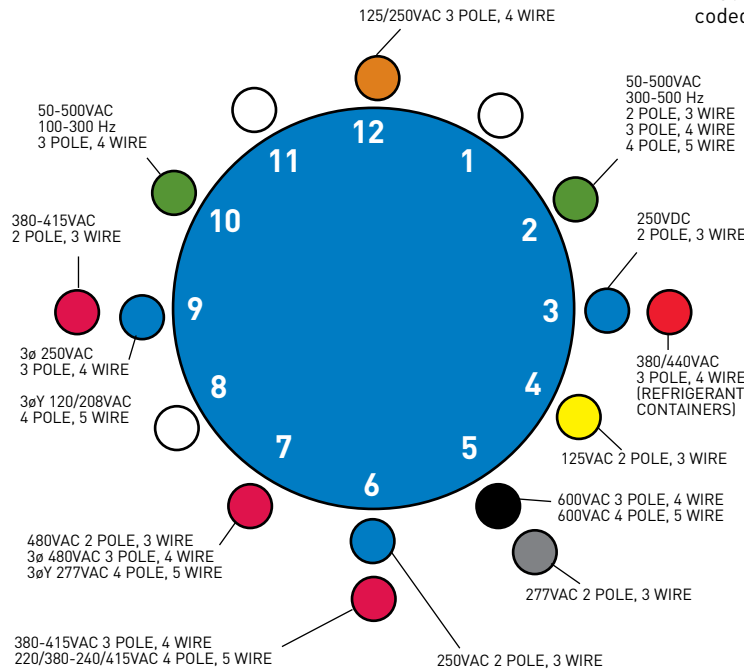

Application Specific

North American Catalog Numbering System

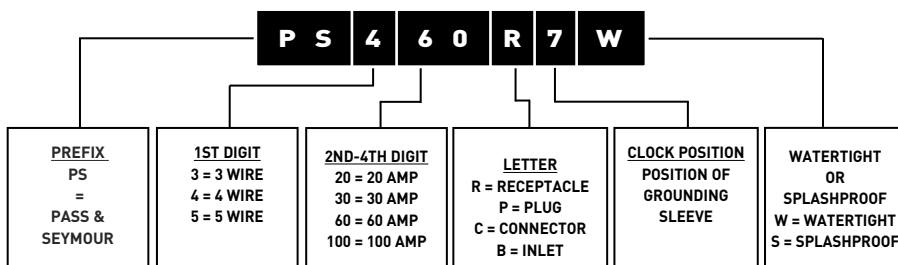

Project
Location/Type

TECHNICAL SPECIFICATIONS

Watertight Pin & Sleeve Receptacles 20, 30, 60 & 100A

Typical Specifications

Manufacturer's Identification: Pass & Seymour® PS460R7W

Description: Receptacle, Power Supply

Type: 3 Pole, 4 Wire Grounding

Rating: 60A, 3 Phase 480VAC

Configuration: IEC 309-2, Clock Position 7, Watertight (IP67)

3rd Party Compliance: UL Listed to UL Standard 1682; CSA Certified to CSA 22.2 No. 182.2; UL Classified to IEC 309-1 and IEC 309-2

AMPS	POLES & WIRES	CONFIG. RECEP/ CONN.	VOLTAGE/ COLOR CODING	CATALOG NUMBER	AMPS	POLES & WIRES	CONFIG. RECEP/ CONN.	VOLTAGE/ COLOR CODING	CATALOG NUMBER
20	□ 2P3W		125	PS320R4W	30	□ 2P3W		125	PS330R4W
20	□ 2P3W		250	PS320R6W	30	□ 2P3W		250	PS330R6W
20	□ 2P3W		480	PS320R7W	30	□ 2P3W		480	PS330R7W
20	□ 2P3W		277	PS420R12W	30	□ 3P4W		125/250	PS430R12W
20	□ 3P4W		125/250	PS420R12W	30	□ 3P4W		3Ø250	PS430R9W
20	□ 3P4W		3Ø250	PS420R9W	30	□ 3P4W		3Ø480	PS430R7W
20	□ 3P4W		3Ø480	PS420R7W	30	□ 3P4W		3Ø600	PS430R5W
20	□ 3P4W		3Ø600	PS420R5W	30	□ 3P4W		380/440	PS430R3W*
20	□ 4P5W		3ØY120/208	PS520R9W	30	□ 4P5W		3ØY120/208	PS530R9W
20	□ 4P5W		3ØY277/480	PS520R7W	30	□ 4P5W		3ØY277/480	PS530R7W
20	□ 4P5W		3ØY347/600	PS520R5W	30	□ 4P5W		3ØY347/600	PS530R5W

AMPS	POLES & WIRES	CONFIG. RECEP/ CONN.	VOLTAGE/ COLOR CODING	CATALOG NUMBER	AMPS	POLES & WIRES	CONFIG. RECEP/ CONN.	VOLTAGE/ COLOR CODING	CATALOG NUMBER
60	□ 2P3W		125	PS360R4W	100	□ 2P3W		125	PS3100R4W
60	□ 2P3W		250	PS360R6W	100	□ 2P3W		250	PS3100R6W
60	□ 2P3W		480	PS360R7W	100	□ 2P3W		480	PS3100R7W
60	□ 3P4W		125/250	PS460R12W	100	□ 3P4W		125/250	PS4100R12W
60	□ 3P4W		3Ø250	PS460R9W	100	□ 3P4W		3Ø250	PS4100R9W
60	□ 3P4W		3Ø480	PS460R7W	100	□ 3P4W		3Ø480	PS4100R7W
60	□ 3P4W		3Ø600	PS460R5W	100	□ 3P4W		3Ø600	PS4100R5W
60	□ 4P5W		3ØY120/208	PS560R9W	100	□ 4P5W		3ØY120/208	PS5100R9W
60	□ 4P5W		3ØY277/480	PS560R7W	100	□ 4P5W		3ØY277/480	PS5100R7W
60	□ 4P5W		3ØY347/600	PS560R5W	100	□ 4P5W		3ØY347/600	PS5100R5W

*Application specific.

Project
Location/Type

TECHNICAL SPECIFICATIONS

Watertight Pin & Sleeve Receptacles 20, 30, 60 & 100A

Performance

Electrical

Dielectric Voltage Withstand:	3000V maximum
Maximum Working Voltage:**	600V RMS, 60Hz - 400Hz
Current Interrupting:	Certified for current interrupting at full-rated current
Temperature Rise:	Maximum 30°C temperature rise at full-rated current after 50 cycles of 150% overload (at 0.75 to 0.80 power factor)
Endurance:	20 Amp: 5000 cycles with full-rated current and voltage 30, 60 & 100 Amp: 2000 cycles with full-rated current and voltage applied on every other cycle

Mechanical

Impact Resistance: Device dropped 8 times from a height of 2.5 feet with 7.5 feet of cord attached (per CSA 182.1)

Cord Grip Retention:	Force, Lbs.*	Torque, Ft. lbs.*
20A	30	.4
30A	75	.5
60A	150	1
100A	150	1

*Applied to minimum recommended cable size

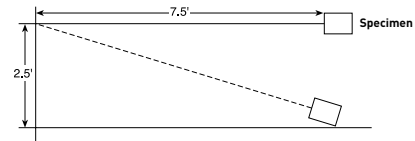

Cord Accommodation: Round portable service cords. Diameters commensurate with the device rating as defined in UL62, CSA C22.2, No. 49, and the harmonized (HAR) European Standard

Terminal Identification: Identified in accordance with North American convention, UL1682, and IEC 309-1, 309-2

Product Identification: Identification and ratings are labeled on the device housing

Environmental

Moisture Resistance:	Watertight per IEC 309-1.
Flammability:	Contact with live parts: V2 or V0. Enclosure: HB or better per UL94
Operating Temperature:	+80°C maximum continuous, -50°C minimum without impact

Materials

	20 Amp	30 Amp	60 Amp	100 Amp
Housing:	Polyamide 6	Polyamide 6	Valox	Valox
Cover	Polyamide 66	Polyamide 66	Valox	Valox
Cover Spring:	Stainless Steel	Stainless Steel	Stainless Steel	Stainless Steel
Sealing Gasket:	Neoprene	Neoprene	Neoprene	Neoprene
Mounting Gasket:	Neoprene	Neoprene	Neoprene	Neoprene
Contact Carrier:	Polyamide 6	Polyamide 6	Polyamide 6	Polyamide 6
Sleeves:	Brass with Nickel Plate	Brass with Nickel Plate	Brass with Nickel Plate	Brass with Nickel Plate
Terminal Screws:	Zinc-Plated Steel	Zinc-Plated Steel	Zinc-Plated Steel	Zinc-Plated Steel

**Rated for copper wire only.

AMPS	WIRE CONFIG.		A	B	C	D	E	F
WATERTIGHT RECEPTACLES								
20	2 Pole, 3 Wire	inch	2.85	1.80	1.60	3.40	2.05	2.36
	3 Pole, 4 Wire	inch	3.20	1.90	1.60	3.80	2.36	2.75
	4 Pole, 5 Wire	inch	3.40	2.00	1.70	3.80	2.36	2.75
30	2 Pole, 3 Wire	inch	3.72	2.60	1.80	4.30	2.75	3.15
	3 Pole, 4 Wire	inch	3.72	2.60	1.90	4.30	2.75	3.15
	4 Pole, 5 Wire	inch	3.98	2.70	1.95	4.30	2.75	3.15
60	2 Pole, 3 Wire	inch	4.20	3.10	3.50	5.00	3.03	3.35
	3 Pole, 4 Wire	inch	4.20	3.10	3.50	5.00	3.03	3.35
	4 Pole, 5 Wire	inch	4.20	3.10	3.50	5.00	3.03	3.35
100	2 Pole, 3 Wire	inch	5.20	2.20	4.40	5.60	4.88	4.88
	3 Pole, 4 Wire	inch	5.20	2.20	4.40	5.60	4.88	4.88
	4 Pole, 5 Wire	inch	5.20	2.20	4.40	5.60	4.88	4.88

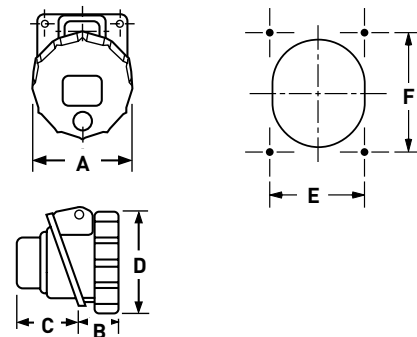

Project
Location/Type

TECHNICAL SPECIFICATIONS

Watertight Pin & Sleeve Plugs 20, 30, 60 & 100A

Typical Specifications

Manufacturer's Identification: Pass & Seymour® PS460P7W
 Description: Plug, Power Supply
 Type: 3 Pole, 4 Wire Grounding
 Rating: 60A, 3 Phase 480VAC
 Configuration: IEC 309-2, Clock Position 7, Watertight (IP67)
 3rd Party Compliance: UL Listed to UL Standard 1682; CSA Certified to CSA 22.2 No. 182.2;
 UL Classified to IEC 309-1 and IEC 309-2

AMPS	POLES & WIRES	CONFIG. RECEP/ CONN.	VOLTAGE/ COLOR CODING	CATALOG NUMBER	AMPS	POLES & WIRES	CONFIG. RECEP/ CONN.	VOLTAGE/ COLOR CODING	CATALOG NUMBER	AMPS	POLES & WIRES	CONFIG. RECEP/ CONN.	VOLTAGE/ COLOR CODING	CATALOG NUMBER
20	□ 2P3W		125	PS320P4W	30	□ 2P3W		125	PS330P4W	60	□ 2P3W		125	PS360P4W
20	□ 2P3W		250	PS320P6W	30	□ 2P3W		250	PS330P6W	60	□ 2P3W		250	PS360P6W
20	□ 2P3W		480	PS320P7W	30	□ 2P3W		480	PS330P7W	60	□ 2P3W		480	PS360P7W
20	□ 2P3W		277	PS320P5W	30	□ 3P4W		125/250	PS430P12W	60	□ 3P4W		125/250	PS460P12W
20	□ 3P4W		125/250	PS420P12W	30	□ 3P4W		3Ø250	PS430P9W	60	□ 3P4W		3Ø250	PS460P9W
20	□ 3P4W		3Ø250	PS420P9W	30	□ 3P4W		3Ø480	PS430P7W	60	□ 3P4W		3Ø480	PS460P7W
20	□ 3P4W		3Ø480	PS420P7W	30	□ 3P4W		3Ø600	PS430P5W	60	□ 3P4W		3Ø600	PS460P5W
20	□ 3P4W		3Ø600	PS420P5W	30	□ 3P4W		380/440	PS430P3W*	60	□ 4P5W		3ØY120/208	PS560P9W
20	□ 4P5W		3ØY120/208	PS520P9W	30	□ 4P5W		3ØY120/208	PS530P9W	60	□ 4P5W		3ØY277/480	PS560P7W
20	□ 4P5W		3ØY277/480	PS520P7W	30	□ 4P5W		3ØY277/480	PS530P7W	60	□ 4P5W		3ØY347/600	PS560P5W
20	□ 4P5W		3ØY347/600	PS520P5W	30	□ 4P5W		3ØY347/600	PS530P5W					

*Application specific.

AMPS	POLES & WIRES	CONFIG. RECEP/ CONN.	VOLTAGE/ COLOR CODING	CATALOG NUMBER
100	□ 2P3W		125	PS3100P4W
100	□ 2P3W		250	PS3100P6W
100	□ 2P3W		480	PS3100P7W
100	□ 3P4W		125/250	PS4100P12W
100	□ 3P4W		3Ø250	PS4100P9W
100	□ 3P4W		3Ø480	PS4100P7W
100	□ 3P4W		3Ø600	PS4100P5W
100	□ 4P5W		3ØY120/208	PS5100P9W
100	□ 4P5W		3ØY277/480	PS5100P7W
100	□ 4P5W		3ØY347/600	PS5100P5W

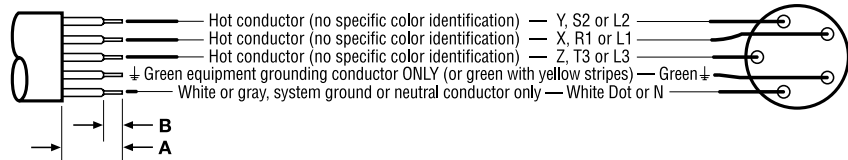

Cable Stripping Guide

DEVICE SIZE	CONDUCTORS	A		B	
		INCHES	(MM)	INCHES	(MM)
20 AMP	All	1-1/8	29	1/2	12
30 AMP	All	1-1/2	38	13/16	21
60 AMP	All	2-3/4	70	13/16	21
100 AMP	All	5-5/16	135	1-3/8	35

Tightening Guide

DEVICE SIZE	TERMINAL SCREW		CABLE CLAMP SCREW		ASSEMBLY SCREW		COMPRESSION NUT	
	IN-LBS	N-M	IN-LBS	N-M	IN-LBS	N-M	IN-LBS	N-M
20 AMP	7	.8	6	.8	7	.8	18-36	2-4
30 AMP	7	.8	6	.8	7	.8	18-36	2-4
60 AMP	17	1.9	12	1.4	7	.8	45-90	5-10
100 AMP	70	7.9	15	1.8	7	.8	45-90	5-10

TECHNICAL SPECIFICATIONS

Project
Location/Type

TECHNICAL SPECIFICATIONS

Watertight Pin & Sleeve Plugs 20, 30, 60 & 100A

Performance

Electrical

Dielectric Voltage Withstand: 3000V maximum
 Maximum Working Voltage:** 600V RMS, 60Hz - 400Hz
 Current Interrupting: Certified for current interrupting at full-rated current
 Temperature Rise: Maximum 30°C temperature rise at full-rated current after 50 cycles of 150% overload (at 0.75 to 0.80 power factor)
 Endurance: 20 Amp: 5000 cycles with full-rated current and voltage
 30, 60 & 100 Amp: 2000 cycles with full-rated current and voltage applied on every other cycle

Mechanical

Impact Resistance: Device dropped 8 times from a height of 2.5 feet with 7.5 feet of cord attached (per CSA 182.1)
 Cord Grip Retention:

	Force, Lbs.*	Torque, Ft. lbs.*
20A	30	.4
30A	75	.5
60A	150	1
100A	150	1

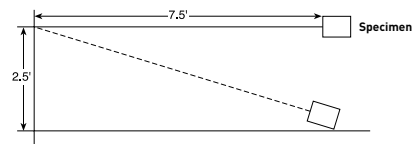

*Applied to minimum recommended cable size

Cord Accommodation: Round portable service cords. Diameters commensurate with the device rating as defined in UL62, CSA C22.2, No. 49, and the harmonized (HAR) European Standard
 Terminal Identification: Identified in accordance with North American convention, UL1682, and IEC 309-1, 309-2
 Product Identification: Identification and ratings are labeled on the device housing

Environmental

Moisture Resistance: Watertight per IEC 309-1.
 Flammability: Contact with live parts: V2 or V0. Enclosure: HB or better per UL94
 Operating Temperature: +80°C maximum continuous, -50°C minimum without impact

Materials

	20 Amp	30 Amp	60 Amp	100 Amp
Housing:	Polyamide 6	Polyamide 6	Valox	Valox
Locking Ring:	Polyamide 66	Polyamide 66	Valox	Valox
Sealing Gasket:	Neoprene	Neoprene	Neoprene	Neoprene
Housing Gasket:	Neoprene	Neoprene	Neoprene	Neoprene
Back Body:	Polyamide 6	Polyamide 6	Valox	Valox
Contact Carrier:	Polyamide 6	Polyamide 6	Polyamide 6	Polyamide 6
Pins:	Brass with Nickel Plate	Brass with Nickel Plate	Brass with Nickel Plate	Brass with Nickel Plate
Terminal Screws:	Zinc-Plated Steel	Zinc-Plated Steel	Zinc-Plated Steel	Zinc-Plated Steel
Cord Grip:	Polyamide 6	Polyamide 6	Polyamide 66	Polyamide 66
Grommet:	Natural Rubber	Natural Rubber	Natural Rubber	Natural Rubber
Cord Grip Screws:	Stainless Steel	Stainless Steel	Stainless Steel	Stainless Steel
Assembly Screws:	Stainless Steel	Stainless Steel	Stainless Steel	Stainless Steel

**Rated for copper wire only.

AMPS	WIRE CONFIG.		A	B	C	D	E	F
WATERTIGHT CONNECTORS								
20	2 Pole, 3 Wire	inch	5.30	2.85		.31-.59		
	3 Pole, 4 Wire	inch	5.50	3.20		.31-.59		
	4 Pole, 5 Wire	inch	6.00	3.40		.39-.71		
30	2 Pole, 3 Wire	inch	6.50	3.70		.39-.71		
	3 Pole, 4 Wire	inch	6.50	3.70		.47-.87		
	4 Pole, 5 Wire	inch	6.70	3.98		.47-.87		
60	2 Pole, 3 Wire	inch	10.00	4.50		.63-1.04		
	3 Pole, 4 Wire	inch	10.00	4.50		.73-1.14		
	4 Pole, 5 Wire	inch	10.00	4.50		.80-1.26		
100	2 Pole, 3 Wire	inch	13.40	5.20		.59-1.97		
	3 Pole, 4 Wire	inch	13.40	5.20		.59-1.97		
	4 Pole, 5 Wire	inch	13.40	5.20		.59-1.97		

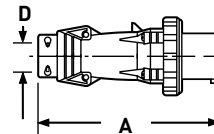

Project
Location/Type

TECHNICAL SPECIFICATIONS

Watertight Pin & Sleeve Connectors 20, 30, 60 & 100A

Typical Specifications

Manufacturer's Identification: Pass & Seymour® PS460C7W

Description: Connector, Power Supply

Type: 3 Pole, 4 Wire Grounding

Rating: 60A, 3 Phase 480VAC

Configuration: IEC 309-2, Clock Position 7, Watertight (IP67)

3rd Party Compliance: UL Listed to UL Standard 1682; CSA Certified to CSA 22.2 No. 182.2; UL Classified to IEC 309-1 and IEC 309-2

AMPS	POLES & WIRES	CONFIG. RECEP/ CONN.	VOLTAGE/ COLOR CODING	CATALOG NUMBER	AMPS	POLES & WIRES	CONFIG. RECEP/ CONN.	VOLTAGE/ COLOR CODING	CATALOG NUMBER	AMPS	POLES & WIRES	CONFIG. RECEP/ CONN.	VOLTAGE/ COLOR CODING	CATALOG NUMBER
20	□ 2P3W		125	PS320C4W	30	□ 2P3W		125	PS330C4W	60	□ 2P3W		125	PS360C4W
20	□ 2P3W		250	PS320C6W	30	□ 2P3W		250	PS330C6W	60	□ 2P3W		250	PS360C6W
20	□ 2P3W		480	PS320C7W	30	□ 2P3W		480	PS330C7W	60	□ 2P3W		480	PS360C7W
20	□ 2P3W		277	PS320C5W	30	□ 3P4W		125/250	PS430C12W	60	□ 3P4W		125/250	PS460C12W
20	□ 3P4W		125/250	PS420C12W	30	□ 3P4W		3Ø250	PS430C9W	60	□ 3P4W		3Ø250	PS460C9W
20	□ 3P4W		3Ø250	PS420C9W	30	□ 3P4W		3Ø480	PS430C7W	60	□ 3P4W		3Ø480	PS460C7W
20	□ 3P4W		3Ø480	PS420C7W	30	□ 3P4W		3Ø600	PS430C5W	60	□ 3P4W		3Ø600	PS460C5W
20	□ 3P4W		3Ø600	PS420C5W	30	□ 3P4W		380/440	PS430C3W*	60	□ 4P5W		3ØY120/208	PS560C9W
20	□ 4P5W		3ØY120/208	PS520C9W	30	□ 4P5W		3ØY120/208	PS530C9W	60	□ 4P5W		3ØY277/480	PS560C7W
20	□ 4P5W		3ØY277/480	PS520C7W	30	□ 4P5W		3ØY277/480	PS530C7W	60	□ 4P5W		3ØY347/600	PS560C5W
20	□ 4P5W		3ØY347/600	PS520C5W	30	□ 4P5W		3ØY347/600	PS530C5W					

*Application specific.

AMPS	POLES & WIRES	CONFIG. RECEP/ CONN.	VOLTAGE/ COLOR CODING	CATALOG NUMBER
100	□ 2P3W		125	PS3100C4W
100	□ 2P3W		250	PS3100C6W
100	□ 2P3W		480	PS3100C7W
100	□ 3P4W		125/250	PS4100C12W
100	□ 3P4W		3Ø250	PS4100C9W
100	□ 3P4W		3Ø480	PS4100C7W
100	□ 3P4W		3Ø600	PS4100C5W
100	□ 4P5W		3ØY120/208	PS5100C9W
100	□ 4P5W		3ØY277/480	PS5100C7W
100	□ 4P5W		3ØY347/600	PS5100C5W

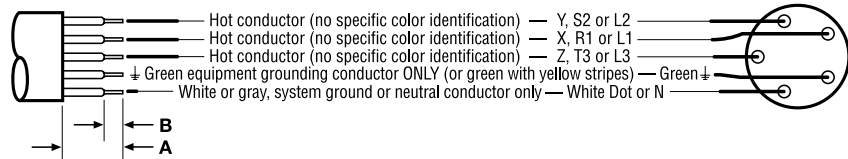

Cable Stripping Guide

DEVICE SIZE	CONDUCTORS	A		B	
		INCHES	(MM)	INCHES	(MM)
20 AMP	All	1-1/8	29	1/2	12
30 AMP	All	1-1/2	38	13/16	21
60 AMP	All	2-3/4	70	13/16	21
100 AMP	All	5-5/16	135	1-3/8	35

Tightening Guide

DEVICE SIZE	TERMINAL SCREW		CABLE CLAMP SCREW		ASSEMBLY SCREW		COMPRESSION NUT	
	IN-LBS	N-M	IN-LBS	N-M	IN-LBS	N-M	IN-LBS	N-M
20 AMP	7	.8	6	.8	7	.8	18-36	2-4
30 AMP	7	.8	6	.8	7	.8	18-36	2-4
60 AMP	17	1.9	12	1.4	7	.8	45-90	5-10
100 AMP	70	7.9	15	1.8	7	.8	45-90	5-10

TECHNICAL SPECIFICATIONS

Project
Location/Type

TECHNICAL SPECIFICATIONS

Watertight Pin & Sleeve Connectors 20, 30, 60 & 100A

Performance

Electrical

Dielectric Voltage Withstand:	3000V maximum
Maximum Working Voltage:**	600V RMS, 60Hz - 400Hz
Current Interrupting:	Certified for current interrupting at full-rated current
Temperature Rise:	Maximum 30°C temperature rise at full-rated current after 50 cycles of 150% overload (at 0.75 to 0.80 power factor)
Endurance:	20 Amp: 5000 cycles with full-rated current and voltage 30, 60 & 100 Amp: 2000 cycles with full-rated current and voltage applied on every other cycle

Mechanical

Impact Resistance: Device dropped 8 times from a height of 2.5 feet with 7.5 feet of cord attached (per CSA 182.1)

Cord Grip Retention:	Force, Lbs.*	Torque, Ft. lbs.*
20A	30	.4
30A	75	.5
60A	150	1
100A	150	1

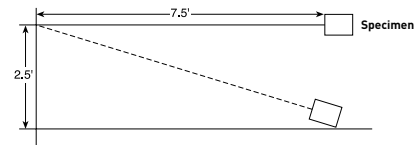

*Applied to minimum recommended cable size

Cord Accommodation: Round portable service cords. Diameters commensurate with the device rating as defined in UL62, CSA C22.2, No. 49, and the harmonized (HAR) European Standard

Terminal Identification: Identified in accordance with North American convention, UL1682, and IEC 309-1, 309-2

Product Identification: Identification and ratings are labeled on the device housing

Environmental

Moisture Resistance:	Watertight per IEC 309-1.
Flammability:	Contact with live parts: V2 or V0. Enclosure: HB or better per UL94
Operating Temperature:	+80°C maximum continuous, -50°C minimum without impact

Materials

	20 Amp	30 Amp	60 Amp	100 Amp
Housing:	Polyamide 6	Polyamide 6	Valox	Valox
Cover:	Polyamide 66	Polyamide 66	Valox	Valox
Cover Spring:	Stainless Steel	Stainless Steel	Stainless Steel	Stainless Steel
Sealing Gasket:	Neoprene	Neoprene	Neoprene	Neoprene
Housing Gasket:	Neoprene	Neoprene	Neoprene	Neoprene
Back Body:	Polyamide 6	Polyamide 6	Valox	Valox
Contact Carrier:	Polyamide 6	Polyamide 6	Polyamide 6	Polyamide 6
Sleeves:	Brass with Nickel Plate	Brass with Nickel Plate	Brass with Nickel Plate	Brass with Nickel Plate
Terminal Screws:	Zinc-Plated Steel	Zinc-Plated Steel	Zinc-Plated Steel	Zinc-Plated Steel
Cord Grip:	Polyamide 6	Polyamide 6	Polyamide 66	Polyamide 66
Grommet:	Natural Rubber	Natural Rubber	Natural Rubber	Natural Rubber
Cord Grip Screws:	Stainless Steel	Stainless Steel	Stainless Steel	Stainless Steel
Assembly Screws:	Stainless Steel	Stainless Steel	Stainless Steel	Stainless Steel

**Rated for copper wire only.

AMPS	WIRE CONFIG.		A	B	C	D	E	F
WATERTIGHT CONNECTORS								
20	2 Pole, 3 Wire	inch	5.90	2.85	3.00	.31-.59		
	3 Pole, 4 Wire	inch	6.00	3.20	3.40	.31-.59		
	4 Pole, 5 Wire	inch	6.70	3.40	3.50	.39-.71		
30	2 Pole, 3 Wire	inch	7.00	3.70	3.90	.39-.71		
	3 Pole, 4 Wire	inch	7.00	3.70	3.90	.47-.87		
	4 Pole, 5 Wire	inch	7.30	3.98	4.10	.47-.87		
60	2 Pole, 3 Wire	inch	10.90	4.50	4.70	.63-1.04		
	3 Pole, 4 Wire	inch	10.90	4.50	4.70	.73-1.14		
	4 Pole, 5 Wire	inch	10.90	4.50	4.70	.80-1.26		
100	2 Pole, 3 Wire	inch	14.30	5.20	5.30	.59-1.97		
	3 Pole, 4 Wire	inch	14.30	5.20	5.30	.59-1.97		
	4 Pole, 5 Wire	inch	14.30	5.20	5.30	.59-1.97		

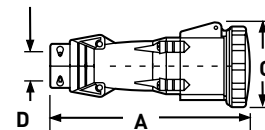

Project	
Location/Type	

TECHNICAL SPECIFICATIONS

Watertight Pin & Sleeve Inlets 60 & 100A

Typical Specifications

Manufacturer's Identification: Pass & Seymour® PS460B7W
 Description: Inlet, Power Supply
 Type: 3 Pole, 4 Wire Grounding
 Rating: 60A, 3 Phase 480VAC
 Configuration: IEC 309-2, Clock Position 7, Watertight (IP67)
 3rd Party Compliance: UL Listed to UL Standard 1682; CSA Certified to CSA 22.2 No. 182.2; UL Classified to IEC 309-1 and IEC 309-2

AMPS	POLES & WIRES	CONFIG. RECEP/ CONN.	VOLTAGE/ COLOR CODING	CATALOG NUMBER	AMPS	POLES & WIRES	CONFIG. RECEP/ CONN.	VOLTAGE/ COLOR CODING	CATALOG NUMBER
60	□ 2P3W		125	PS360B4W	100	□ 2P3W		125	PS3100B4W
60	□ 2P3W		250	PS360B6W	100	□ 2P3W		250	PS3100B6W
60	□ 2P3W		480	PS360B7W	100	□ 2P3W		480	PS3100B7W
60	□ 3P4W		125/250	PS460B12W	100	□ 3P4W		125/250	PS4100B12W
60	□ 3P4W		3Ø250	PS460B9W	100	□ 3P4W		3Ø250	PS4100B9W
60	□ 3P4W		3Ø480	PS460B7W	100	□ 3P4W		3Ø480	PS4100B7W
60	□ 3P4W		3Ø600	PS460B5W	100	□ 3P4W		3Ø600	PS4100B5W
60	□ 4P5W		3ØY120/208	PS560B9W	100	□ 4P5W		3ØY120/208	PS5100B9W
60	□ 4P5W		3ØY277/480	PS560B7W	100	□ 4P5W		3ØY277/480	PS5100B7W
60	□ 4P5W		3ØY347/600	PS560B5W	100	□ 4P5W		3ØY347/600	PS5100B5W

Performance

Electrical

Dielectric Voltage Withstand: 3000V maximum
 Maximum Working Voltage:** 600V RMS, 60Hz - 400Hz
 Current Interrupting: Certified for current interrupting at full-rated current
 Temperature Rise: Maximum 30°C temperature rise at full-rated current after 50 cycles of 150% overload (at 0.75 to 0.80 power factor)
 Endurance: 20 Amp: 5000 cycles with full-rated current and voltage
 30, 60 & 100 Amp: 2000 cycles with full-rated current and voltage applied on every other cycle

Mechanical

Impact Resistance: Device dropped 8 times from a height of 2.5 feet with 7.5 feet of cord attached (per CSA 182.1)

Cord Grip Retention:	Force, Lbs.*	Torque, Ft. lbs.*
20A	30	.4
30A	75	.5
60A	150	1
100A	150	1

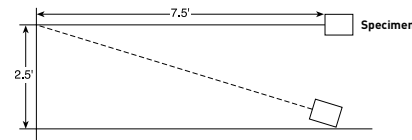

*Applied to minimum recommended cable size

Cord Accommodation: Round portable service cords. Diameters commensurate with the device rating as defined in UL62, CSA C22.2, No. 49, and the harmonized (HAR) European Standard

Terminal Identification: Identified in accordance with North American convention, UL1682, and IEC 309-1, 309-2

Product Identification: Identification and ratings are labeled on the device housing

Environmental

Moisture Resistance: Watertight per IEC 309-1.
 Flammability: Contact with live parts: V2 or V0. Enclosure: HB or better per UL94
 Operating Temperature: +80°C maximum continuous, -50°C minimum without impact

**Rated for copper wire only.

TECHNICAL SPECIFICATIONS

Project
Location/Type

TECHNICAL SPECIFICATIONS

Watertight Pin & Sleeve Inlets 60 & 100A

Materials

	60 Amp	100 Amp
Housing:	Valox	Valox
Mounting Flange:	Valox	Valox
Locking Ring:	Valox	Valox
Sealing Gasket:	Neoprene	Neoprene
Mounting Gasket:	Neoprene	Neoprene
Contact Carrier:	Polyamide 6	Polyamide 6
Pins:	Brass with Nickel Plate	Brass with Nickel Plate
Terminal Screws:	Zinc-Plated Steel	Zinc-Plated Steel

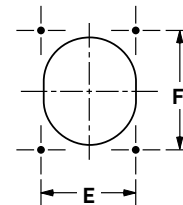
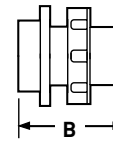
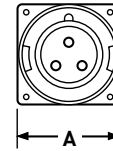

AMPS	WIRE CONFIG.		A	B	C	D	E	F
WATERTIGHT INLETS								
60	2 Pole, 3 Wire	inch	4.50	4.25			3.03	3.35
	3 Pole, 4 Wire	inch	4.50	4.25			3.03	3.35
	4 Pole, 5 Wire	inch	4.50	4.25			3.03	3.35
100	2 Pole, 3 Wire	inch	5.75	5.71			4.88	4.88
	3 Pole, 4 Wire	inch	5.75	5.71			4.88	4.88
	4 Pole, 5 Wire	inch	5.75	5.71			4.88	4.88

Project
Location/Type

TECHNICAL SPECIFICATIONS

Splashproof Pin & Sleeve Receptacles 20, 30 & 60A

Typical Specifications

Manufacturer's Identification: Pass & Seymour® PS460R7S

Description: Receptacle, Power Supply

Type: 3 Pole, 4 Wire Grounding

Rating: 60A, 3 Phase 480VAC

Configuration: IEC 309-2, Clock Position 7, Splashproof (IP44)

3rd Party Compliance: UL Listed to UL Standard 1682; CSA Certified to CSA 22.2 No. 182.2; UL Classified to IEC 309-1 and IEC 309-2

AMPS	POLES & WIRES	CONFIG. RECEP/ CONN.	VOLTAGE/ COLOR CODING	CATALOG NUMBER	AMPS	POLES & WIRES	CONFIG. RECEP/ CONN.	VOLTAGE/ COLOR CODING	CATALOG NUMBER
20	□ 2P3W		125	PS320R4S	30	□ 2P3W		125	PS330R4S
20	□ 2P3W		250	PS320R6S	30	□ 2P3W		250	PS330R6S
20	□ 2P3W		277	PS320R5S	30	□ 2P3W		480	PS330R7S
20	□ 3P4W		125/250	PS420R12S	30	□ 3P4W		125/250	PS430R12S
20	□ 3P4W		3Ø250	PS420R9S	30	□ 3P4W		3Ø250	PS430R9S
20	□ 3P4W		3Ø480	PS420R7S	30	□ 3P4W		3Ø480	PS430R7S
20	□ 3P4W		3Ø600	PS420R5S	30	□ 3P4W		3Ø600	PS430R5S
20	□ 4P5W		3ØY120/208	PS520R9S	30	□ 4P5W		3ØY120/208	PS530R9S
20	□ 4P5W		3ØY277/480	PS520R7S	30	□ 4P5W		3ØY277/480	PS530R7S
20	□ 4P5W		3ØY347/600	PS520R5S	30	□ 4P5W		3ØY347/600	PS530R5S

AMPS	POLES & WIRES	CONFIG. RECEP/ CONN.	VOLTAGE/ COLOR CODING	CATALOG NUMBER
60	□ 2P3W		250	PS360R6S
60	□ 2P3W		480	PS360R7S
60	□ 3P4W		125/250	PS460R12S
60	□ 3P4W		3Ø250	PS460R9S
60	□ 3P4W		3Ø480	PS460R7S
60	□ 3P4W		3Ø600	PS460R5S
60	□ 4P5W		3ØY120/208	PS560R9S
60	□ 4P5W		3ØY277/480	PS560R7S
60	□ 4P5W		3ØY347/600	PS560R5S

Project

Location/Type

TECHNICAL SPECIFICATIONS

Splashproof Pin & Sleeve Receptacles 20, 30 & 60A

Performance

Electrical

Dielectric Voltage Withstand: 3000V maximum
 Maximum Working Voltage:** 600V RMS, 60Hz - 400Hz
 Current Interrupting: Certified for current interrupting at full-rated current
 Temperature Rise: Maximum 30°C temperature rise at full-rated current after 50 cycles of 150% overload (at 0.75 to 0.80 power factor)
 Endurance: 20 Amp: 5000 cycles with full-rated current and voltage
 30, 60 & 100 Amp: 2000 cycles with full-rated current and voltage applied on every other cycle

Mechanical

Impact Resistance: Device dropped 8 times from a height of 2.5 feet with 7.5 feet of cord attached (per CSA 182.1)

Cord Grip Retention:	Force, Lbs.*	Torque, Ft. lbs.*
20A	30	.4
30A	75	.5
60A	150	1
100A	150	1

*Applied to minimum recommended cable size

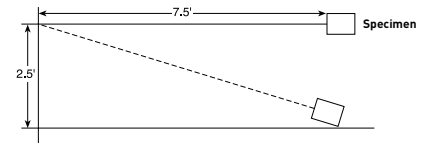

Cord Accommodation: Round portable service cords. Diameters commensurate with the device rating as defined in UL62, CSA C22.2, No. 49, and the harmonized (HAR) European Standard
 Terminal Identification: Identified in accordance with North American convention, UL1682, and IEC 309-1, 309-2
 Product Identification: Identification and ratings are labeled on the device housing

Environmental

Moisture Resistance: Watertight per IEC 309-1.
 Flammability: Contact with live parts: V2 or V0. Enclosure: HB or better per UL94
 Operating Temperature: +80°C maximum continuous, -50°C minimum without impact

Materials

	20 Amp	30 Amp	60 Amp
Housing:	Polyamide 6	Polyamide 6	Valox
Cover:	Polyamide 66	Polyamide 66	Valox
Cover Spring:	Stainless Steel	Stainless Steel	Stainless Steel
Mounting Gasket:	Neoprene	Neoprene	Neoprene
Contact Carrier:	Polyamide 6	Polyamide 6	Polyamide 6
Sleeves:	Brass	Brass	Brass with Nickel Plate
Terminal Screws:	Zinc-Plated Steel	Zinc-Plated Steel	Zinc-Plated Steel

**Rated for copper wire only.

AMPS	WIRE CONFIG.		A	B	C	D	E	F
SPLASHPROOF RECEPTACLES								
20	2 Pole, 3 Wire	inch	2.50	1.57	1.60	3.10	2.05	2.36
	3 Pole, 4 Wire	inch	2.90	1.57	1.73	3.46	2.36	2.75
	4 Pole, 5 Wire	inch	2.90	1.73	1.73	3.66	2.36	2.75
30	2 Pole, 3 Wire	inch	3.30	2.10	1.97	4.06	2.75	3.15
	3 Pole, 4 Wire	inch	3.30	2.10	1.97	4.06	2.75	3.15
	4 Pole, 5 Wire	inch	3.30	2.20	2.05	4.20	2.75	3.15
60	2 Pole, 3 Wire	inch	4.20	3.50	2.76	5.08	3.03	3.35
	3 Pole, 4 Wire	inch	4.20	3.50	2.76	5.08	3.03	3.35
	4 Pole, 5 Wire	inch	4.20	3.50	2.76	5.08	3.03	3.35

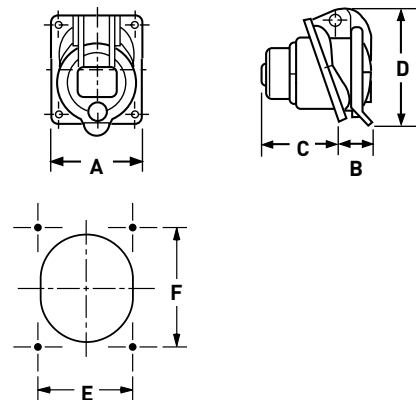

Project
Location/Type

TECHNICAL SPECIFICATIONS

Splashproof Pin & Sleeve Plugs 20, 30 & 60A

Typical Specifications

Manufacturer's Identification: Pass & Seymour® PS320P4S

Description: Plug, Power Supply

Type: 3 Pole, 4 Wire Grounding

Rating: 60A, 3 Phase 480VAC

Configuration: IEC 309-2, Clock Position 7, Splashproof (IP44)

3rd Party Compliance: UL Listed to UL Standard 1682; CSA Certified to CSA 22.2 No. 182.2; UL Classified to IEC 309-1 and IEC 309-2

AMPS	POLES & WIRES	CONFIG. RECEP/ CONN.	VOLTAGE/ COLOR CODING	CATALOG NUMBER	AMPS	POLES & WIRES	CONFIG. RECEP/ CONN.	VOLTAGE/ COLOR CODING	CATALOG NUMBER
20	□ 2P3W		125	PS320P4S	30	□ 2P3W		125	PS330P4S
20	□ 2P3W		250	PS320P6S	30	□ 2P3W		250	PS330P6S
20	□ 2P3W		277	PS320P5S	30	□ 2P3W		480	PS330P7S
20	□ 3P4W		125/250	PS420P12S	30	□ 3P4W		125/250	PS430P12S
20	□ 3P4W		3ø250	PS420P9S	30	□ 3P4W		3ø250	PS430P9S
20	□ 3P4W		3ø480	PS420P7S	30	□ 3P4W		3ø480	PS430P7S
20	□ 3P4W		3ø600	PS420P5S	30	□ 3P4W		3ø600	PS430P5S
20	□ 4P5W		3øY120/208	PS520P9S	30	□ 4P5W		3øY120/208	PS530P9S
20	□ 4P5W		3øY277/480	PS520P7S	30	□ 4P5W		3øY277/480	PS530P7S
20	□ 4P5W		3øY347/600	PS520P5S	30	□ 4P5W		3øY347/600	PS530P5S

AMPS	POLES & WIRES	CONFIG. RECEP/ CONN.	VOLTAGE/ COLOR CODING	CATALOG NUMBER
60	□ 2P3W		250	PS360P6S
60	□ 2P3W		480	PS360P7S
60	□ 3P4W		125/250	PS460P12S
60	□ 3P4W		3ø250	PS460P9S
60	□ 3P4W		3ø480	PS460P7S
60	□ 3P4W		3ø600	PS460P5S
60	□ 4P5W		3øY120/208	PS560P9S
60	□ 4P5W		3øY277/480	PS560P7S
60	□ 4P5W		3øY347/600	PS560P5S

Project

Location/Type

TECHNICAL SPECIFICATIONS

Splashproof Pin & Sleeve Plugs 20, 30 & 60A

Performance

Electrical

- Dielectric Voltage Withstand: 3000V maximum
- Maximum Working Voltage:** 600V RMS, 60Hz-400Hz
- Current Interrupting: Certified for current interrupting at full-rated current
- Temperature Rise: Maximum 30°C temperature rise at full-rated current after 50 cycles of 150% overload (at 0.75 to 0.80 power factor)
- Endurance: 20 Amp: 5000 cycles with full-rated current and voltage
30, 60 & 100 Amp: 2000 cycles with full-rated current and voltage applied on every other cycle

Mechanical

Impact Resistance: Device dropped 8 times from a height of 2.5 feet with 7.5 feet of cord attached (per CSA 182.1)

Cord Grip Retention:	Force, Lbs.*	Torque, Ft. lbs.*
20A	30	.4
30A	75	.5
60A	150	1
100A	150	1

*Applied to minimum recommended cable size

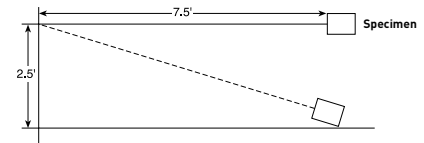

- Cord Accommodation: Round portable service cords. Diameters commensurate with the device rating as defined in UL62, CSA C22.2, No. 49, and the harmonized (HAR) European Standard
- Terminal Identification: Identified in accordance with North American convention, UL1682, and IEC 309-1, 309-2
- Product Identification: Identification and ratings are labeled on the device housing

Environmental

- Moisture Resistance: Watertight per IEC 309-1.
- Flammability: Contact with live parts: V2 or V0. Enclosure: HB or better per UL94
- Operating Temperature: +80°C maximum continuous, -50°C minimum without impact

Materials

	20 Amp	30 Amp	60 Amp
Housing:	Polyamide 6	Polyamide 6	Valox
Housing Gasket:	Neoprene	Neoprene	Neoprene
Back Body:	Polyamide 6	Polyamide 6	Valox
Contact Carrier:	Polyamide 6	Polyamide 6	Polyamide 6
Pins:	Brass	Brass	Brass with Nickel Plate
Terminal Screws:	Zinc-Plated Steel	Zinc-Plated Steel	Zinc-Plated Steel
Cord Grip:	Polyamide 6	Polyamide 6	Polyamide 66
Grommet:	Natural Rubber	Natural Rubber	Natural Rubber
Cord Grip Screws:	Stainless Steel	Stainless Steel	Stainless Steel
Assembly Screws:	Stainless Steel	Stainless Steel	Stainless Steel

**Rated for copper wire only.

AMPS	WIRE CONFIG.		A	B	C	D	E	F
SPLASHPROOF PLUGS								
20	2 Pole, 3 Wire	inch	5.30	2.17		.31-.59		
	3 Pole, 4 Wire	inch	5.50	2.36		.31-.59		
	4 Pole, 5 Wire	inch	6.00	2.60		.39-.71		
30	2 Pole, 3 Wire	inch	6.50	2.78		.39-.71		
	3 Pole, 4 Wire	inch	6.50	2.78		.47-.87		
	4 Pole, 5 Wire	inch	6.70	3.03		.47-.87		
60	2 Pole, 3 Wire	inch	10.00	4.02		.63-1.04		
	3 Pole, 4 Wire	inch	10.00	4.02		.73-1.14		
	4 Pole, 5 Wire	inch	10.00	4.02		.80-1.26		

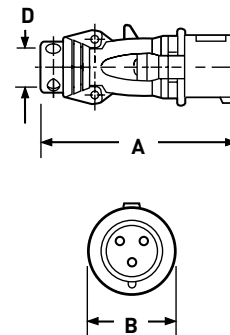

Project	
Location/Type	

TECHNICAL SPECIFICATIONS

Splashproof Pin & Sleeve Connectors 20, 30 & 60A

Typical Specifications

Manufacturer's Identification: Pass & Seymour® PS320C4S

Description: Connector, Power Supply

Type: 3 Pole, 4 Wire Grounding

Rating: 60A, 3 Phase 480VAC

Configuration: IEC 309-2, Clock Position 7, Splashproof (IP44)

3rd Party Compliance: UL Listed to UL Standard 1682; CSA Certified to CSA 22.2 No. 182.2; UL Classified to IEC 309-1 and IEC 309-2

AMPS	POLES & WIRES	CONFIG. RECEP/ CONN.	VOLTAGE/ COLOR CODING	CATALOG NUMBER	AMPS	POLES & WIRES	CONFIG. RECEP/ CONN.	VOLTAGE/ COLOR CODING	CATALOG NUMBER
20	□ 2P3W		125	PS320C4S	30	□ 2P3W		125	PS330C4S
20	□ 2P3W		250	PS320C6S	30	□ 2P3W		250	PS330C6S
20	□ 2P3W		277	PS320C5S	30	□ 2P3W		480	PS330C7S
20	□ 3P4W		125/250	PS420C12S	30	□ 3P4W		125/250	PS430C12S
20	□ 3P4W		3ø250	PS420C9S	30	□ 3P4W		3ø250	PS430C9S
20	□ 3P4W		3ø480	PS420C7S	30	□ 3P4W		3ø480	PS430C7S
20	□ 3P4W		3ø600	PS420C5S	30	□ 3P4W		3ø600	PS430C5S
20	□ 4P5W		3øY120/208	PS520C9S	30	□ 4P5W		3øY120/208	PS530C9S
20	□ 4P5W		3øY277/480	PS520C7S	30	□ 4P5W		3øY277/480	PS530C7S
20	□ 4P5W		3øY347/600	PS520C5S	30	□ 4P5W		3øY347/600	PS530C5S

AMPS	POLES & WIRES	CONFIG. RECEP/ CONN.	VOLTAGE/ COLOR CODING	CATALOG NUMBER
60	□ 2P3W		250	PS360C6S
60	□ 2P3W		480	PS360C7S
60	□ 3P4W		125/250	PS460C12S
60	□ 3P4W		3ø250	PS460C9S
60	□ 3P4W		3ø480	PS460C7S
60	□ 3P4W		3ø600	PS460C5S
60	□ 4P5W		3øY120/208	PS560C9S
60	□ 4P5W		3øY277/480	PS560C7S
60	□ 4P5W		3øY347/600	PS560C5S

Project
Location/Type

TECHNICAL SPECIFICATIONS

Splashproof Pin & Sleeve Connectors 20, 30 & 60A

Performance

Electrical

Dielectric Voltage Withstand:	3000V maximum
Maximum Working Voltage:**	600V RMS, 60Hz - 400Hz
Current Interrupting:	Certified for current interrupting at full-rated current
Temperature Rise:	Maximum 30°C temperature rise at full-rated current after 50 cycles of 150% overload (at 0.75 to 0.80 power factor)
Endurance:	20 Amp: 5000 cycles with full-rated current and voltage 30 & 60 Amp: 2000 cycles with full-rated current and voltage applied on every other cycle

Mechanical

Impact Resistance: Device dropped 8 times from a height of 2.5 feet with 7.5 feet of cord attached (per CSA 182.1)

Cord Grip Retention:	Force, Lbs.*	Torque, Ft. lbs.*
20A	30	.4
30A	75	.5
60A	150	1
100A	150	1

*Applied to minimum recommended cable size

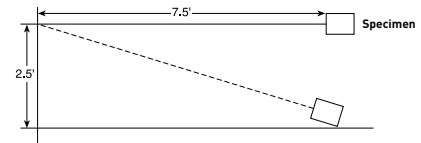

Cord Accommodation: Round portable service cords. Diameters commensurate with the device rating as defined in UL62, CSA C22.2, No. 49, and the harmonized (HAR) European Standard

Terminal Identification: Identified in accordance with North American convention, UL1682, and IEC 309-1, 309-2

Product Identification: Identification and ratings are labeled on the device housing

Environmental

Moisture Resistance: Watertight per IEC 309-1.

Flammability: Contact with live parts: V2 or V0. Enclosure: HB or better per UL94

Operating Temperature: +80°C maximum continuous, -50°C minimum without impact

Materials

	20 Amp	30 Amp	60 Amp
Housing:	Polyamide 6	Polyamide 6	Valox
Cover:	Polyamide 66	Polyamide 66	Valox
Cover Spring:	Stainless Steel	Stainless Steel	Stainless Steel
Housing Gasket:	Neoprene	Neoprene	Neoprene
Back Body:	Polyamide 6	Polyamide 6	Valox
Contact Carrier:	Polyamide 6	Polyamide 6	Polyamide 66
Sleeves:	Brass	Brass	Brass with Nickel Plate
Terminal Screws:	Zinc-Plated Steel	Zinc-Plated Steel	Zinc-Plated Steel
Cord Grip:	Polyamide 6	Polyamide 6	Polyamide 66
Grommet:	Natural Rubber	Natural Rubber	Natural Rubber
Cord Grip Screws:	Stainless Steel	Stainless Steel	Stainless Steel
Assembly Screws:	Stainless Steel	Stainless Steel	Stainless Steel

**Rated for copper wire only.

AMPS	WIRE CONFIG.		A	B	C	D	E	F
SPLASHPROOF CONNECTORS								
20	2 Pole, 3 Wire	inch	5.79	2.15	2.91	.31-.59		
	3 Pole, 4 Wire	inch	5.94	2.42	3.19	.31-.59		
	4 Pole, 5 Wire	inch	6.77	2.73	3.54	.39-.71		
30	2 Pole, 3 Wire	inch	6.97	2.80	3.66	.39-.71		
	3 Pole, 4 Wire	inch	6.97	2.80	3.66	.47-.87		
	4 Pole, 5 Wire	inch	7.20	3.05	3.94	.47-.87		
60	2 Pole, 3 Wire	inch	10.75	3.78	4.67	.63-1.04		
	3 Pole, 4 Wire	inch	10.75	3.78	4.67	.73-1.14		
	4 Pole, 5 Wire	inch	10.75	3.78	4.67	.80-1.26		

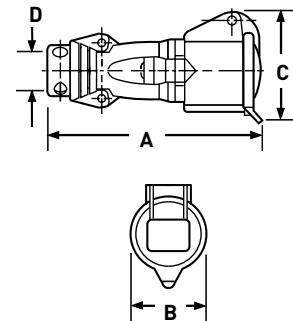

Project
Location/Type

TECHNICAL SPECIFICATIONS

Splashproof Pin & Sleeve Inlets 20, 30 & 60A

Typical Specifications

Manufacturer's Identification: Legrand/Pass & Seymour PS460B7S

Description: Inlet, Power Supply

Type: 3 Pole, 4 Wire Grounding

Rating: 60A, 3 Phase 480VAC

Configuration: IEC 309-2, Clock Position 7, Splashproof (IP44)

3rd Party Compliance: UL Listed to UL Standard 1682; CSA Certified to CSA 22.2 No. 182.2; UL Classified to IEC 309-1 and IEC 309-2

AMPS	POLES & WIRES	CONFIG. RECEP/ CONN.	VOLTAGE/ COLOR CODING	CATALOG NUMBER	AMPS	POLES & WIRES	CONFIG. RECEP/ CONN.	VOLTAGE/ COLOR CODING	CATALOG NUMBER
20	□ 2P3W		125	PS320B4S	30	□ 2P3W		125	PS330B4S
20	□ 2P3W		250	PS320B6S	30	□ 2P3W		250	PS330B6S
20	□ 2P3W		277	PS320B5S	30	□ 2P3W		480	PS330B7S
20	□ 3P4W		125/250	PS420B12S	30	□ 3P4W		125/250	PS430B12S
20	□ 3P4W		3ø250	PS420B9S	30	□ 3P4W		3ø250	PS430B9S
20	□ 3P4W		3ø480	PS420B7S	30	□ 3P4W		3ø480	PS430B7S
20	□ 3P4W		3ø600	PS420B5S	30	□ 3P4W		3ø600	PS430B5S
20	□ 4P5W		3øY120/208	PS520B9S	30	□ 4P5W		3øY120/208	PS530B9S
20	□ 4P5W		3øY277/480	PS520B7S	30	□ 4P5W		3øY277/480	PS530B7S
20	□ 4P5W		3øY347/600	PS520B5S	30	□ 4P5W		3øY347/600	PS530B5S

AMPS	POLES & WIRES	CONFIG. RECEP/ CONN.	VOLTAGE/ COLOR CODING	CATALOG NUMBER
60	□ 2P3W		250	PS360B6S
60	□ 2P3W		480	PS360B7S
60	□ 3P4W		125/250	PS460B12S
60	□ 3P4W		3ø250	PS460B9S
60	□ 3P4W		3ø480	PS460B7S
60	□ 3P4W		3ø600	PS460B5S
60	□ 4P5W		3øY120/208	PS560B9S
60	□ 4P5W		3øY277/480	PS560B7S
60	□ 4P5W		3øY347/600	PS560B5S

Project

Location/Type

TECHNICAL SPECIFICATIONS

Splashproof Pin & Sleeve Inlets 20, 30 & 60A

Performance

Electrical

Dielectric Voltage Withstand: 3000V maximum
 Maximum Working Voltage:** 600V RMS, 60Hz - 400Hz
 Current Interrupting: Certified for current interrupting at full-rated current
 Temperature Rise: Maximum 30°C temperature rise at full-rated current after 50 cycles of 150% overload (at 0.75 to 0.80 power factor)
 Endurance: 20 Amp: 5000 cycles with full-rated current and voltage
 30 & 60 Amp: 2000 cycles with full-rated current and voltage applied on every other cycle

Mechanical

Impact Resistance: Device dropped 8 times from a height of 2.5 feet with 7.5 feet of cord attached (per CSA 182.1)

Cord Grip Retention:	Force, Lbs.*	Torque, Ft. lbs.*
20A	30	.4
30A	75	.5
60A	150	1
100A	150	1

*Applied to minimum recommended cable size

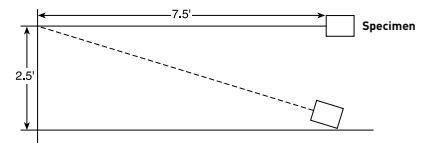

Cord Accommodation: Round portable service cords. Diameters commensurate with the device rating as defined in UL62, CSA C22.2, No. 49, and the harmonized (HAR) European Standard
 Terminal Identification: Identified in accordance with North American convention, UL1682, and IEC 309-1, 309-2
 Product Identification: Identification and ratings are labeled on the device housing

Environmental

Moisture Resistance: Watertight per IEC 309-1.
 Flammability: Contact with live parts: V2 or V0. Enclosure: HB or better per UL94
 Operating Temperature: +80°C maximum continuous, -50°C minimum without impact

Materials

	20 Amp	30 Amp	60 Amp
Housing:	Polyamide 6	Polyamide 6	Valox
Mounting Flange:	Polyamide 6	Polyamide 6	Valox
Mounting Gasket:	Neoprene	Neoprene	Neoprene
Contact Carrier:	Polyamide 6	Polyamide 6	Polyamide 6
Pins:	Brass	Brass	Brass with Nickel Plate
Terminal Screws:	Zinc-Plated Steel	Zinc-Plated Steel	Zinc-Plated Steel

**Rated for copper wire only.

AMPS	WIRE CONFIG.		A	B	C	D	E	F
SPLASHPROOF INLETS								
20	2 Pole, 3 Wire	inch	2.83	3.07			2.44	3.70
	3 Pole, 4 Wire	inch	3.70	3.39			3.27	4.29
	4 Pole, 5 Wire	inch	3.70	3.39			3.27	4.29
30	2 Pole, 3 Wire	inch	3.98	4.37			3.54	5.86
	3 Pole, 4 Wire	inch	3.98	4.37			3.54	5.86
	4 Pole, 5 Wire	inch	3.98	4.25			3.54	5.86
60	2 Pole, 3 Wire	inch	4.50	4.25			3.03	3.35
	3 Pole, 4 Wire	inch	4.50	4.25			3.03	3.35
	4 Pole, 5 Wire	inch	4.50	4.25			3.03	3.35

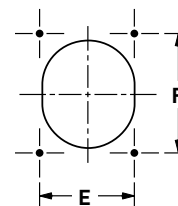
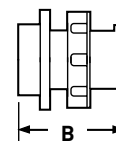
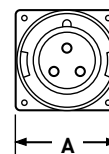

Project
Location/Type

TECHNICAL SPECIFICATIONS

Watertight Pin & Sleeve Non-Fusible Mechanical Interlock 20, 30, 60 & 100A

Typical Specifications

Manufacturer's Identification: Pass & Seymour® PS560MIR5W
 Description: Non-Fusible Pin & Sleeve Mechanical Interlock
 Electrical Type: 3 Pole + Neutral + Earth
 Rating: 60A, 3Ø, 600VAC 15 HP standard, 40 HP maximum
 Configuration: IEC Clock Position 5
 Enclosure Type: NEMA 4X (watertight, hosedown), 12K (dusttight, falling dirt), IP67 suitability
 Conduit Location: Top or bottom feed. Unit shipped with no holes drilled; a top and bottom feed spot drill is provided for locating hole saw or knockout. End user decides at installation whether top or bottom feed is appropriate. No closure plug kits required.

AMPS	CATALOG NUMBER	VOLTAGE/COLOR CODING	HORSEPOWER RATING
20	PS320MIR4W	120VAC	5
20	PS320MIR6W	240VAC	5
20	PS320MIR7W	480VAC	5
20	PS420MIR12W	120/240VAC	1 HP @ 120V 2 HP @ 208-240V L-L
20	PS420MIR9W	3Ø 240VAC	5
20	PS420MIR7W	3Ø 480VAC	10
20	PS420MIR5W	3Ø 600VAC	15
20	PS520MIR9W	3ØY 120/208VAC	5

AMPS	CATALOG NUMBER	VOLTAGE/COLOR CODING	HORSEPOWER RATING
30	PS330MIR4W	120VAC	2
30	PS330MIR6W	240VAC	5
30	PS330MIR7W	480VAC	10
30	PS430MIR9W	3Ø 240VAC	7.5
30	PS430MIR7W	3Ø 480VAC	15
30	PS430MIR5W	3Ø 600VAC	20
30	PS430MIR3W	380/440VAC	15
30	PS530MIR9W	3ØY 120/208VAC	5
30	PS530MIR7W	3ØY 277/480VAC	15
30	PS530MIR5W	3ØY347/600	20

AMPS	CATALOG NUMBER	VOLTAGE/COLOR CODING	HORSEPOWER RATING
60	PS360MIR4W	120VAC	5
60	PS360MIR6W	240VAC	7.5 @ 208-240V
60	PS360MIR7W	480VAC	10
60	PS460MIR12W	120/240VAC	3 @ 120V 7.5 @ 208-240VAC L-L
60	PS460MIR9W	3Ø 240VAC	15
60	PS460MIR7W	3Ø 480VAC	30
60	PS460MIR5W	3Ø 600VAC	40
60	PS560MIR9W	3ØY 120/208VAC	15
60	PS560MIR7W	3ØY 277/480VAC	30
60	PS560MIR5W	3ØY 347/600VAC	40
60	PS560MIR5W	347/600VAC	40

AMPS	CATALOG NUMBER	VOLTAGE/COLOR CODING	HORSEPOWER RATING
100	PS3100MIR4W	120VAC	5
100	PS3100MIR6W	240VAC	10 @ 208V 15 @ 240V
100	PS3100MIR7W	480VAC	30
100	PS4100MIR5W	3Ø 600VAC	50
100	PS4100MIR7W	3Ø 480VAC	50
100	PS4100MIR9W	3Ø 240VAC	25
100	PS4100MIR12W	120/240VAC	5 @ 120V 10 @ 208V L-L 15 @ 240V L-L
100	PS5100MIR5W	3ØY 347/600VAC	50
100	PS5100MIR7W	3ØY 277/480VAC	50
100	PS5100MIR9W	3ØY 120/208VAC	20



TECHNICAL SPECIFICATIONS

Project
Location/Type

TECHNICAL SPECIFICATIONS

Watertight Pin & Sleeve Non-Fusible Mechanical Interlock 20, 30, 60 & 100A

Performance

Electrical

- Dielectric Voltage Withstand: 3000V minimum
- Maximum Working Voltage:** 600V RMS, 60Hz - 400Hz
- Current Interrupting: Listed for current interrupting at full-rated current and voltage
- Short Circuit Withstand Rating: For use on circuit capable of delivering not more than 10,000 RMS amps at receptacle voltage rating
- Operations: Mechanical: 15,000 cycles
Electrical: 10,000 cycles
- Auxiliary Contacts: 10A @ 600V
1 N.O. & 1 N.C.

Mechanical

- Impact Resistance: Per UL746C
- Terminal Identification: Per UL, CSA, and IEC specifications
- Product Identification: Identification and rating on external and internal labels
- Mounting : External adjustable feet with five (5) positions.
Can be mounted directly to channel or strut
(no washer required)

Environmental

- Moisture Resistance: Per UL50, section 35, NEMA Enclosure Type 4X (watertight, hosesdown)
Per UL50, section 35, NEMA Enclosure Type 12K (dusttight, falling dirt) IP67 suitability
- Flammability: UL94 5VA and VO Classification
- Operating Temperature: Maximum continuous: +60°C
Minimum continuous: -50°C without impact
- UV Resistance: All enclosure materials are UV stable

Materials

- Enclosure Cover: Valox 357®
- Enclosure Base: Valox 357®
- Enclosure Gasket: Neoprene
- Switch Handle: Valox 357®
- Switch Handle Seal: Neoprene
- Shaft: Brass
- Gear Mechanism: 1/8" Zinc-Plated Steel
- Locktab: 10% Glass-Filled Nylon
- Switch Key: 10% Glass-Filled Nylon
- Mounting Feet: Valox 357®
- Mounting Feet Screws: 300 Series Stainless Steel
- Enclosure Assembly Screws: 300 Series Stainless Steel
- Enclosure Assembly Inserts: Brass
- Receptacle Lid: Valox 357®
- Receptacle Gasketing: Neoprene
- Receptacle Lid Hinge Spring: 300 Series Stainless Steel
- Receptacle Contact Carrier: Polyamide 6
- Receptacle Sleeves: Brass/Nickel-Plate
- Receptacle Terminal Screws: Zinc-Plated Steel
- Grounding Plate: Zinc-Plated Steel
- Cover Chain: 300 Series Stainless Steel
- Conduit Hub: Aluminum/Zinc
20/30 amp shipped with one (1) 1" 60 amp shipped with one (1) 1 1/4" 100 amp shipped with one (1) 1 1/2" (will also fit a 2" hub, not provided)

**Rated for copper wire only.

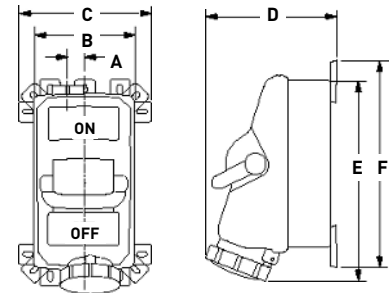

Front

Side

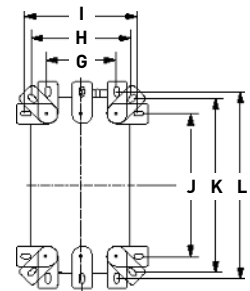

Back

(See dimensions below.)

Non-Fusible Mechanical Interlock Dimensions

AMPS	A	B	C	D	E	F	G	H	I	J	K	L
20	1.38	6.88	9.13	8.00	12.38	11.06	4.75	6.88	7.75	8.00	10.13	11.00
30	1.38	6.88	9.13	8.25	12.38	11.50	4.75	6.88	7.75	8.00	10.13	11.00
60	1.19	6.88	9.13	9.00	13.63	14.13	4.75	6.88	7.75	9.75	11.88	12.75
100	1.19	6.88	9.13	9.50	14.13	14.13	4.75	6.88	7.75	9.75	11.88	12.75

All measurements shown in inches.

Project
Location/Type

TECHNICAL SPECIFICATIONS

Occupancy Sensors



General Specifications

- Occupancy sensors shall control lighting and/or HVAC in the sensed area only.
- Controlled lighting and/or HVAC zones shall not be larger than 2500 sq. ft.
- The contractor shall be responsible for a complete, operable system, and installation should be warranted for a period of one year after acceptance.
- The product shall be warranted for a period of (5) five years for wall switch sensors, ceiling sensors, and power packs.
- Occupancy sensors shall be installed as per manufacturer's recommendations.
- Specific low-voltage wire surface routing shall be approved by the facilities engineer.
- Sensor and control unit manufacturer must have experience in the lighting and/or HVAC controls industry equal to a minimum of (5) five years with a minimum of (5) five similar projects.
- Contractor shall be responsible for contacting the manufacturer for proper placement and adjustment of sensor.

Wall Box Switches

WP250, DSW100*, DSW200* Features & Benefits

Zero Crossing:	This feature ensures the closing of the contacts as close to 0° as possible, extending the life of the relay contacts, and limiting the effect of inrush current from some electronic ballasts.
ASIC Chip:	Application Specific Integrated Component chip is a custom-designed microprocessor that improves reliability and boosts immunity to RFI and EMI.
30 sec. - 30 min. Time Delay:	Such a large range allows users to adjust time delay to fit the application and ensure maximum savings without compromising convenience.
180° Coverage	Provides detection even along the wall it is mounted on.
Maximum Rating:	Allows for the combining of potential savings with room size. Wall switches that offer too much wattage handling capacity are used in larger rooms where ceiling sensors should be used, compromising the reliability of the installation.
Self-Adaptive:	On the DSW units only: Units automatically adjust the delay time by monitoring room usage patterns. No user adjustment required, automatically sets delay time for most efficient use of energy.
2 relays for bi-level switching:	The DSW200 is designed for areas with two lighting zones or bi-level lighting applications.
Adjustable Sensitivity:	Enables the installer or user to adjust the sensitivity level to suit the application.
Voltage Drop Protection:	Protects the electronics to ensure long-term performance.
Five-Year Warranty:	Allows installer or user to receive a replacement or refund if a sensor is found to be defective within 5 years of purchase.

*Dual Technology

Wall- and Ceiling-Mount Sensors

Feature	CX105	CX1051	CI2051/CI205	WT605/1105/2205	DT300
Technology:	Passive Infrared	Passive Infrared	Passive Infrared	Ultrasonic**	Dual Technology
Coverage Pattern:	Wide Angle	Long Range	360°	360°	360°
Mounting Method:	Wall or Ceiling	Wall or Ceiling	Ceiling	Ceiling	Ceiling
Adjustable Sensitivity:	Yes	Yes	Yes	Yes	Yes
Viewing Range:	2000 sq. ft.	90 x 20 ft.	500/1200 sq. ft.	600/1100/2200 sq. ft.	1000 sq. ft.
Fresnel Lens:***	Yes	Yes	Yes	N/A	Yes
ASIC:†	Yes	Yes	Yes	Yes	Yes
5-Year Warranty:	Yes	Yes	Yes	Yes	Yes

**Provides occupancy detection around obstacles.

***Dual tech has both Ultrasonic and PIR Fresnel lens.

†Improves reliability and boosts immunity to RFI and EMI.

Power Packs

BZ50 Features

Load Rating at 120V:	20A Ballast 20A Incandescent	Mounting Method:	1/2" Knockout
Load Rating at 277V:	20A Ballast	Sized to Fit into Approved	
Output Rating:	24VDC; 225mA	Enclosure for Plenum Applications:	Yes
		Teflon-Coated Leads:	Yes
		Five Year Warranty:	Yes

S120/277/347EP Features

120/277VAC Form C Auxiliary Relay Pack	
General Purpose:	(120 & 277) 20A NO/20A NC
Fluorescent Load:	(120 & 277) 20A NO/10A NC
Incandescent Load:	(120) 15A NO/2A NC
Motor Load:	(120) 1 HP NO/1 HP NC, (277) 2 HP NO/2 HP NC

Project
Location/Type

TECHNICAL SPECIFICATIONS

Optional Neutral Sensors

Typical Specifications

Wall switch occupancy sensors shall be cULus listed and California Title 24 Compliant as provided by Wattstopper®. Sensors shall be self-contained and fit in a standard wall box. Sensors shall be suitable for neutral required or neutral-less locations in a single unit. Sensors shall be capable of detecting changes in the infrared background caused by motion. Sensors shall be capable of switching incandescent and fluorescent lighting loads on and off. Sensors shall use optics that operate with a 180 degree view. The wall switch occupancy sensor shall be equipped with controls to adjust sensitivity and ambient light threshold. The sensor shall also offer time delay adjustment from 30 seconds to 30 minutes, as well as an override. Conforms to NEMA WD-1 and WD-6. Wall switch occupancy sensors shall be CULus listed and California Title 24.

Wall Box Switches

WS301, PW301, PW302, DSW301, DSW302 Features & Benefits

Optional Neutral:	Optional Neutral to work with existing wiring or to meet local or national code requirements.
Zero Crossing:	This feature ensures the closing of the contacts as close to 0° as possible, extending the life of the relay contacts, and limiting the effect of inrush current from some electronic ballasts.
ASIC Chip:	Application Specific Integrated Component chip is a custom-designed microprocessor that improves reliability and boosts immunity to RFI and EMI.
30 sec. - 30 min. Time Delay:	Such a large range allows users to adjust time delay to fit the application and ensure maximum savings without compromising convenience.
180° Coverage	Provides detection even along the wall it is mounted on.
Maximum Rating:	Allows for the combining of potential savings with room size. Wall switches that offer too much wattage handling capacity are used in larger rooms where ceiling sensors should be used, compromising the reliability of the installation.
Self-Adaptive:	Units automatically adjust the delay time by monitoring room usage patterns. No user adjustment required, automatically sets delay time for most efficient use of energy.
2 Relays for Bi-Level Switching:	The PW302 and DSW302 are designed for areas with two lighting zones or bi-level lighting applications.
Adjustable Sensitivity:	Enables the installer or user to adjust the sensitivity level to suit the application.
Voltage Drop Protection:	Protects the electronics to ensure long-term performance.
Five-Year Warranty:	Allows installer or user to receive a replacement or refund if a sensor is found to be defective within 5 years of purchase.

Wall- and Ceiling-Mount Sensors

Features	WS301	PW301	PW302	DSW301	DSW302
Technology:	Passive Infrared	Passive Infrared	Passive Infrared	Dual Technology	Dual Technology
Coverage Pattern:	180°	180°	180°	180°	180°
Controls:	Wall Box – Single Relay	Wall Box – Single Relay	Wall Box – Dual Relay	Wall Box – Single Relay	Wall Box – Dual Relay
Neutral:	Optional	Optional	Optional	Optional	Optional
Single Pole/Multi-Way:	Single Pole	Multi	Multi	Multi	Multi
Adjustable Sensitivity:	Yes	Yes	Yes	Yes	Yes
Viewable Range:	900 sq. ft.	1000 sq. ft.	1000 sq. ft.	1000 sq. ft./400 sq. ft.	1000 sq. ft./400 sq. ft.
Audio Shutoff Alert:		Selectable	Selectable	Selectable	Selectable
Fresnel Lens:*	Yes	Yes	Yes	Yes	Yes
ASIC**	Yes	Yes	Yes	Yes	Yes
Load 120V	0-1000W Ballast, LED, Tungsten, 1/6hp	0-1000W Ballast, LED, Tungsten, 1/6hp	0-800W Ballast, LED, Tungsten, 1/6hp	0-1000W Ballast, LED, Tungsten, 1/6hp	0-800W Ballast, LED, Tungsten, 1/6hp
Load 277V	0-1200W Ballast, LED, 1/6hp	0-1200W Ballast, LED, 1/6hp	0-1000W Ballast, LED, 1/6hp	0-1200W Ballast, LED, 1/6hp	0-1000W Ballast, LED, 1/6hp
5 Year Warranty	Yes	Yes	Yes	Yes	Yes

* Dual tech has both Ultrasonic and PIR Fresnel Lens.

** Improves reliability and boosts immunity to RFI and EMI interference.

Project
Location/Type



TECHNICAL SPECIFICATIONS

Wall Switch – WS250, WS301

Typical Specifications

Wall switch occupancy sensors shall be cULus Listed, and California Title 24 Compliant as provided by Wattstopper®. Sensors shall be self-contained and fit in a standard wall box. Sensors shall be capable of detecting changes in the infrared background caused by motion. Sensors shall be capable of switching incandescent and fluorescent lighting loads on and off. Sensors shall use optics that operate with a 180° field of view. The wall switch occupancy sensor shall be equipped with controls to adjust sensitivity and ambient light threshold. The sensor shall also offer a time-delay adjustment from 30 seconds to 30 minutes, as well as an override. Conforms to NEMA WD-1 and WD-6.

CATALOG NUMBER	DESCRIPTION
□ WS250	Passive Infrared Wall Switch
□ WS301	Passive Infrared Wall Switch, Optional Neutral

Performance

Electrical

Supply Voltage: 120/277 Volt AC 60 Hz
 Maximum Load: 800W Incandescent/Fluorescent at 120V 1/6 HP
 1200W Fluorescent at 277V

Minimum Load: None
 AC Switching: WSP250: Normally Open Relay, Zero Crossing Circuitry

Sensor

Technology: Passive Infrared
 Time Delay: Adjustable 30 sec. to 30 min.
 Light Level Adjustment: Adjustable from full daylight to 10 foot-candles
 Sensitivity Adjustment: 20% to 100%
 Spectral Response: 6 to 14 μm
 Field of View: Horizontal: 180°
 Vertical: 2° and 8.6° down from the center

Indicator Light: Red LED flashes when motion is detected
 Lens Type: Two-tier lens

Environmental

Temperature Range: 0°C to 35°C
 Non-condensing Relative Humidity: 20 to 90%

Mechanical

Enclosure Material: Thermoplastic, UV-resistant plastic
 Color(s): Ivory, White, Gray, Light Almond

Third Party Compliance: cULus Listed – UL508 and C22.2 No. 14
 California Title 24 Compliant



WS250W

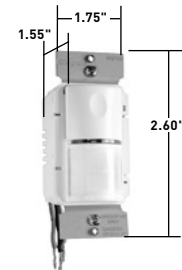

WS301W

Wiring Diagrams on Page N-8.

Project
Location/Type

TECHNICAL SPECIFICATIONS

Dual Technology Wall Switch – DSW100, DSW200



Typical Specifications

Dual technology wall switch occupancy sensors shall be cULus Listed UL508 and C22.2 No. 14, California Title 24 Compliant and RoHS-Compliant as provided by Wattstopper®. Conforms to NEMA WD-1 and WD-6.

CATALOG NUMBER	DESCRIPTION
<input type="checkbox"/> DSW100	Dual Technology Wall Switch Sensor
<input type="checkbox"/> DSW200	Bi-Level Dual Technology Wall Switch Sensor

Performance

Electrical

Supply Voltage:	120/230/277VAC
Maximum Supply Voltage:	277VA
Maximum Load	@ 120 VAC, 0-800 W ballast or tungsten, 1/6 hp @ 277 VAC, 0-1200 W ballast
Frequency:	50-60 Hz

Sensor

Technology:	Passive Infrared and Ultrasonic
PIR Adjustment:	Two Settings – Maximum (100%) and Minimum (50%)
Ultrasonic Adjustment:	Ultrasonic sensitivity can be adjusted using a trimpot. Output frequency of transmitter is fixed at 40kHz.
Time Delay:	Adjustable 5 min. to 30 min.
Light Level Adjustment:	8fc to 180+fc
Spectral Response:	6 to 14 μm
Field of View:	88°; 110° Vertical, 360° Horizontal
Coverage:	1050 sq. ft., 180°
Indicator Light(s):	Red and Green LEDs
Lens Type:	Two Horizontal Layers
Sensor Type:	Multi-Directional Transmitter/Receiver with Quartz Oscillator
Audible Alert:	Selectable

Environmental

Temperature Range:	0°C to 55°C
--------------------	-------------

Mechanical

Enclosure Material:	ABS KJW Flame-Retardant Cicolac, 940-0 or Equivalent
Color(s):	Ivory, White, Black, Gray, Light Almond
Third Party Compliance:	cULus Listed – UL508 and C22.2 No. 14 California Title 24 Compliant RoHS-Compliant

Coverage Diagram on Page N-10.



DSW100W

Project

Location/Type



TECHNICAL SPECIFICATIONS

PIR Wide Angle Sensor – CX105

Typical Specifications

Wide angle motion sensors shall be cULus Listed, and California Title 24 Compliant as provided by Wattstopper®. Sensors shall be ceiling or wall mount type, capable of detecting infrared emissions from personnel movement, and switching lighting and HVAC systems on and off based on occupancy. Wide angle motion sensor switch shall make use of optics that operate within an 88° field of view, offering a typical coverage of up to 1200 sq ft. Mounting shall be wall or ceiling. Motion sensor switch must be used in conjunction with the BZ50 (120/277 VAC supply) switching modules, and capable of handling additional loads with the support of an Auxiliary Relay Pack S120/277/347EP. Also, the sensor shall offer a time delay adjustment from 15 seconds to 30 minutes, as well as an override. Conforms to NEMA WD-1 and WD-6.

CATALOG NUMBER	DESCRIPTION
□ CX105	Passive Infrared Wall/Ceiling Sensor

Performance

Electrical

Supply Voltage:	+ 24VDC Typical
Minimum Supply Voltage:	+ 20VDC
Maximum Supply Voltage:	+ 30VDC
Sensor Output:	+ 24VDC for external relay DC coil drive

Sensor

Technology:	Passive Infrared
Time Delay:	Adjustable 15 sec. to 30 min.
Light Level Adjustment:	No
Sensitivity Adjustment:	14% to 100%
Spectral Response:	6 to 14 μm
Field of View:	88°
Coverage:	Up to 2000 sq. ft.
Indicator Light:	Red LED flashes when motion is detected
Lens Type:	Four horizontal layers

Environment

Temperature Range:	0°C to 35°C
Non-condensing Relative Humidity:	20 to 90%

Mechanical

Enclosure Material:	Thermoplastic, UV-resistant plastic
Color:	White

Third Party Compliance:	cULus Listed – UL508 and C22.2 No. 14 California Title 24 Compliant
--------------------------------	--

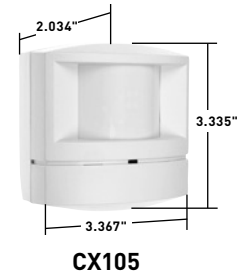

CX105

Coverage Diagram on Page N-15.

Project
Location/Type

TECHNICAL SPECIFICATIONS

PIR Hallway Sensor – CX1051



Typical Specifications

Hallway motion sensors shall be cULus Listed, and California Title 24 Compliant as provided by Wattstopper®. Sensors shall be ceiling or wall mount type, capable of detecting infrared emissions from personnel movement, and switching lighting and HVAC systems on and off based on occupancy. Hallway motion sensor switches shall make use of optics that operate within field of view 90 feet long by 20 feet wide. Mounting shall be wall or ceiling. Motion sensor switch must be used in conjunction with the BZ50 (120/277 VAC supply) switching modules, and capable of handling additional loads by including the support of an Auxiliary Relay Pack S120/277/347EP. Also, the sensor shall offer a time delay adjustment from 15 seconds to 30 minute, as well as an override. Conforms to NEMA WD-1 and WD-6.

CATALOG NUMBER	DESCRIPTION
□ CX1051	Passive Infrared Wall/Ceiling Sensor for hallway applications

Performance

Electrical

Supply Voltage:	+ 24VDC Typical
Minimum Supply Voltage:	+ 20VDC
Maximum Supply Voltage:	+ 30VDC
Sensor Output:	+ 24VDC for external relay DC coil drive

Sensor

Technology:	Passive Infrared
Time Delay:	Adjustable 15 sec. to 30 min.
Light Level Adjustment:	No
Sensitivity Adjustment:	14% to 100%
Spectral Response:	6 to 14 μm
Field of View:	13°
Coverage:	90 linear feet typical
Indicator Light:	Red LED flashes when motion is detected
Lens Type:	Two horizontal layers

Environment

Temperature Range:	0°C to 35°C
Non-condensing Relative Humidity:	20 to 90%

Mechanical

Enclosure Material:	Thermoplastic, UV-resistant plastic
Color:	White
Third Party Compliance:	cULus Listed – UL508 and C22.2 No. 14 California Title 24 Compliant

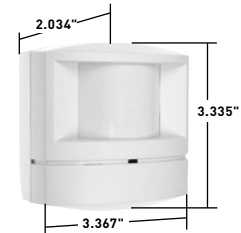

CX1051

Wiring Diagrams on Page N-15.

Project
Location/Type



TECHNICAL SPECIFICATIONS

PIR Occupancy Ceiling Sensors – CI2051, CI205, CI355

Typical Specifications

Motion sensor switches shall be cULus Listed, and California Title 24 Compliant as provided by Wattstopper®. Sensors shall be ceiling mount type, capable of detecting infrared emissions from personnel movement and switching incandescent and fluorescent lighting loads on and off. Motion sensor switches shall make use of optics that operate within a 110° field of view. Motion sensors may be mounted in a drop ceiling, solid ceiling, or wall. Motion sensor switch must be used in conjunction with the BZ50 (120/277 VAC supply) switching modules, and capable of handling additional loads with the support of an Auxiliary Relay Pack S120/277/347EP. Conforms to NEMA WD-1 and WD-6.

CATALOG NUMBER	DESCRIPTION
□ CI2051	Ceiling Sensor, 500 sq. ft.
□ CI205	Ceiling Sensor, 1200 sq. ft.
□ CI355*	Line Voltage Ceiling Sensor, 1200 sq. ft.

*Does not require a power pack.

Performance

Electrical

Supply Voltage: + 24VDC Typical
 Minimum Supply Voltage: + 20VDC
 Maximum Supply Voltage: + 30VDC
 Sensor Output: + 24VDC for external relay DC coil drive

Sensor

Technology: Passive Infrared
 Time Delay: 15 sec. to 30 min.
 Light Level Adjustment: No
 Sensitivity Adjustment: Yes
 Spectral Response: 6 to 14 μm
 Field of View: 110° Vertical, 360° Horizontal
 Coverage: Up to 900 sq. ft.
 Indicator Light: Red LED flashes when motion is detected
 Lens Type: Multi-zone fresnel type

Environment

Temperature Range: 0°C to 35°C
 Non-condensing Relative Humidity: 20 to 90%

Mechanical

Enclosure Material: Thermoplastic, UV-resistant plastic
 Color: White

Third Party Compliance: cULus Listed – UL508 and C22.2 No. 14
 California Title 24 Compliant

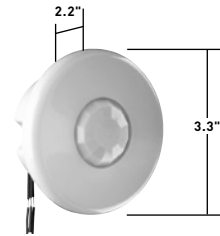

CI2051
CI205

CI2051, CI205 Wiring Diagram

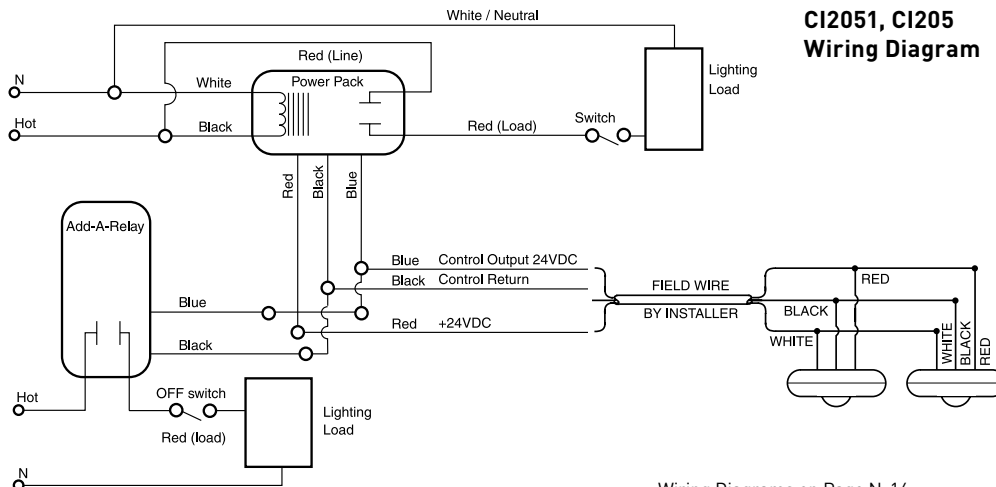

Wiring Diagrams on Page N-16.

TECHNICAL SPECIFICATIONS

Project
Location/Type

TECHNICAL SPECIFICATIONS

Ultrasonic Ceiling Sensors – WT605, WT1105, WT2205



Typical Specifications

Ultrasonic motion sensors shall be cULus Listed, and California Title 24 Compliant as provided by Wattstopper®. Sensors shall be ceiling or wall mount ceiling mount type, capable of detecting motion from personnel movement, and switching lighting and HVAC systems on and off based on occupancy. Ultrasonic motion sensor switches shall use a multi-directional transmitter/receiver system to broadcast ultrasonic 32 kHz sound waves generated by a quartz oscillator. The ultrasonic motion sensor switch must be used in conjunction with BZ50 (120/277 VAC supply) switching modules, and capable of handling additional loads by including the support of an Auxiliary Relay Pack S120/277/347EP. Also, the sensor shall offer a time delay adjustment from 15 seconds to 30 minutes, as well as an override. Conforms to NEMA WD-1 and WD-6.

CATALOG NUMBER	DESCRIPTION
<input type="checkbox"/> WT605	Ultrasonic Ceiling Sensor
<input type="checkbox"/> WT1105	Ultrasonic Ceiling Sensor
<input type="checkbox"/> WT2205	Ultrasonic Ceiling Sensor

Performance

Electrical

Supply Voltage:	+ 24VDC Typical
Minimum Supply Voltage:	+ 20VDC
Maximum Supply Voltage:	+ 30VDC
Sensor Output:	+ 24VDC for external relay DC coil drive

Sensor

Technology:	Ultrasonic
Time Delay:	Adjustable 15 sec. to 30 min.
Light Level Adjustment:	No
Sensitivity Adjustment:	14% to 100%
Frequency:	32 kHz +/- 4 Hz
Coverage:	Up to 600/1100/2200 sq. ft.
Indicator Light:	Red LED flashes when motion is detected
Sensor Type:	Multidirectional transmitter/receiver with quartz oscillator

Environment

Temperature Range:	0°C to 35°C
Non-condensing Relative Humidity:	20 to 90%

Mechanical

Enclosure Material:	Thermoplastic, UV-resistant plastic
Color:	White
Third Party Compliance:	cULus Listed – UL508 and C22.2 No. 14 California Title 24 Compliant

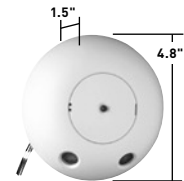

WT605

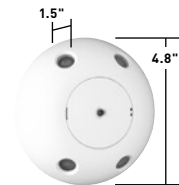

**WT1105
WT2205**

Wiring Diagrams on Page N-17.

Project
Location/Type

TECHNICAL SPECIFICATIONS



Dual-Technology Ceiling Sensor – DT300, DT355

Typical Specifications

The Wattstopper® DT300 Dual Technology Ceiling Sensor shall be cULus Listed, and California Title 24 Compliant as provided by Wattstopper®. The sensor shall detect occupancy in the control area by detecting Doppler shifts in transmitted ultrasound and passive infrared heat changes. Detection verification of both technologies must occur in order to activate lighting systems. Upon verification, detection by either shall hold lighting on. Unit shall be white, ceiling mounted with a flat, unobtrusive appearance and provide 360° coverage. DT300 sensor shall operate at 24 VDC/VAC and utilize a power pack. For additional loads use the Auxiliary Relay Pack S120/277/347EP. Sensor shall have a time delay that is adjustable from 15 seconds to 30 minutes, set by DIP switch. Each sensing technology shall have an LED indicator that remains active at all times in order to verify detection within the area to be controlled. Sensor shall have standard 5 year warranty. Conforms to NEMA WD-1 and WD-6.

CATALOG NUMBER	DESCRIPTION
<input type="checkbox"/> DT300	Dual-Technology Ceiling Sensor
<input type="checkbox"/> DT355*	Line Voltage Dual-Technology Ceiling Sensor

*Does not require a power pack.

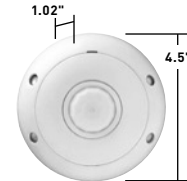

DT300

Performance

Electrical

Supply Voltage: 24VDC Typical for DT300 (DT355 is 120/277VAC)
 Sensor output: + 24VDC for external relay DC coil drive, + 24VDC for external relay DC coil (DT300)
 Current Consumption: 35mA

Sensor

Technology: Ultrasonic and Passive Infrared
 Time Delay: 15 seconds to 30 minutes
 Ultrasonic Sensitivity Adjustment: Min to max (trim pot)
 Passive Infrared Sensitivity Adjustment: 30% to 100% (dip switches)
 Frequency: 40 kHz
 Ultrasonic Coverage: 1076 sq. ft. (100 sq. m)
 Passive Infrared Coverage: 1290 sq. ft. (120 sq m)
 Indicator Lights: Red and Green LEDs

Environment

Temperature Range: 32° to 131°F (0° to 55°C)
 Non-condensing Relative Humidity: 20 to 90%

Mechanical

Material: Thermoplastic, UV-resistant plastic
 Color: White
 Mounting: Mounting hardware for acoustic ceiling tile and keyhole mounting template included

Third Party Compliance: cULus Listed – UL508 and C22.2 No. 14
 California Title 24 Compliant

Wiring Diagrams on Page N-18.

TECHNICAL SPECIFICATIONS

Project
Location/Type

TECHNICAL SPECIFICATIONS

High Bay Passive Infrared (PIR), Line Voltage Occupancy Sensors

Typical Specifications

Manufacturer's Identification: Wattstopper® HBP112L7 and HB350WL

Description: Passive Infrared (PIR) Occupancy Sensor

Type: Passive Infrared Occupancy/Vacancy Sensors with Neutral

Rating: 120/277 VAC, 60Hz

3rd Party Compliance: cULus Listed, UL508 and C22.2 No. 14. Conforms to NEMA WD-1 and WD-6, California Title 24 Compliant.

CATALOG NUMBER	DESCRIPTION
<input type="checkbox"/> HBP112L7	Hi Bay Dry Location Sensor
<input type="checkbox"/> HB350WL3	Hi Bay Wet Location Sensor
<input type="checkbox"/> HB350WL4	

Performance

Electrical

Voltages:	120/277 VAC, 60Hz
Compatible Load Types:	Tungsten, electronic and magnetic ballasts, fluorescent
Load Requirements:	120VAC, 60Hz: 0-1000VA, 1/4HP 230VAC, 50/60Hz: 0-1000VA 277VAC, 60Hz: 0-1200VA, 1/4HP 347VAC, 60Hz: 0-1500VA, 1/4HP

Sensor

Technology:	Passive Infrared
Time Delay:	5, 10, 15, 20, 30 Min via trim
Light Level Adjustment:	Yes on HBP112L7, No on HB350WL
Sensitivity Adjustment:	60% to 100%
Indicator Light(s):	Red LED flashes when motion is detected

Environment

Temperature Range:	HBP112L7: Operating Temperature: 32°F to 158°F (0°C to 70°C) Operating Humidity: 5-95% RH, non-condensing For indoor use only HB350WL: Operating Temperature: -40°F to 131°F (-40°C to 55°C) Operating Humidity: 5-95% RH, non-condensing Maximum Dew Point: 85° F (29°C) UL rated raintight (UL244A and UL508) IP65 rated
--------------------	---

Mechanical:

HBP112L7:	HBP112L7: ABS, flame retardant, UV resistant, impact resistant 100' Aisleway with incl mask ring
HB350WL3:	HB350WL: Polycarbonate, flame retardant, UV resistant, impact resistant Wet Location 360° lens, 40' diameter coverage from 20' height
HB350WL4:	Wet Location 360° lens, 60' diameter coverage from 40' height



HBP112L7



HB350WL3



HB350WL4

Project
Location/Type



TECHNICAL SPECIFICATIONS

Power Pack – BZ50 & Auxiliary Relay Pack - S120/277/347EP

Typical Specifications

Switching modules shall be cULus Listed as provided by Wattstopper®. Switching modules shall contain a 24VAC transformer, a full wave bridge rectifier, and a 24VDC coil-isolated relay capable of handling both incandescent and fluorescent lighting loads as well as inductive loads. Normal current consumption for the relay shall be 36mA, and the coil resistance shall be 660 Ohms. The transformer input shall be 120VAC or 277VAC; output shall be 24VDC, with a maximum current of 114mA. Power Packs shall have Teflon-coated wire leads for use in plenum ceilings.

Auxiliary Relay Pack modules shall be UL and CUL Listed as provided by Wattstopper®. Auxiliary Relay Pack modules shall contain a 24VDC coil-isolated relay capable of handling both incandescent and fluorescent lighting loads as well as inductive loads. Nominal current consumption for the relay shall be 36mA, and the coil resistance shall be 660 Ohms. Auxiliary Relay Pack modules shall have Teflon-coated wire leads for use in plenum ceilings. Conforms to NEMA WD-1 and WD-6.

CATALOG NUMBER	DESCRIPTION
□ BZ50	Power Pack
□ S120/277/347EP	Auxiliary Relay Pack (120/277/347 VAC)

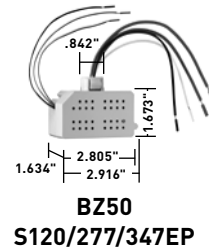

Performance

Transformer

Supply Voltage:	BZ50; 120/277 Volt AC 50/60Hz
Output:	24VDC
	Maximum Current: 225mA (with relay connected)

Relay

Type:	Normally Open
Control Input	

Nominal Current:	36mA
Coil Resistance:	660 Ohms
Nominal Voltage:	24VDC
Maximum Voltage:	28.8VDC
Minimum Voltage:	18VDC

AC Load Output

BZ50/BZ150

Incandescent:	20 Amp Max. (120V, 50 Hz only)
Fluorescent:	20 Amp Max. (120V, 50 Hz or 277V, 60 Hz)
Motor Load:	1 HP (120V, 60 Hz only or 240VAC)

BZ200

Ballast/ELV/MLV/Inc/LED:	20 Amp Max
E-Ballast CFL:	16 Amp Max
Plug Load:	20 Amp Max

Motor Load: 1HP

Environment

Temperature Range:	0°C to 40°C
Non-condensing Relative Humidity:	20 to 90%

Mechanical

Enclosure Material:	Thermoplastic, UL flame class rating 94 V0
Color:	Gray

Third Party Compliance:	cULus Listed – UL508 and C22.2 No. 14 California Title 24 Compliant UL 2043 Plenum Rated
--------------------------------	--

Wiring Diagrams on Page N-20.

Project
Location/Type

TECHNICAL SPECIFICATIONS

Titan® Series Incandescent & Magnetic Low-Voltage

Typical Specifications

Manufacturer's Identification: Wattstopper® CD700

Description: Incandescent Dimmer

Type: Single Pole

Rating: 120V, 700W

3rd Party Compliance: cULus Listed, File Number E95219 Standard UL1472 Solid State Dimming Controls, Standard C22.2 No. 184-1; File Number E109655 Standard UL1917 Solid State Fan Controls, Standard C22.2 No. 156. California Title 24 Compliant. Conforms to NEMA WD-1 and WD-6.

CATALOG NUMBER	DESCRIPTION	RATINGS	NARROW OR WIDE
<input type="checkbox"/> CD700	Single Pole, Slide-to-OFF	120V, 700W	Narrow
<input type="checkbox"/> CD703P	Single Pole/3-Way, Preset	120V, 700W	Narrow
<input type="checkbox"/> CD1100	Single Pole, Slide-to-OFF	120V, 1100W	Narrow
<input type="checkbox"/> CD1103P	Single Pole/3-Way, Preset	120V, 1100W	Narrow
<input type="checkbox"/> CD1600	Single Pole, Slide-to-OFF	120V, 1600W	Wide
<input type="checkbox"/> CD1603P	Single Pole/3-Way, Preset	120V, 1600W	Wide
<input type="checkbox"/> CD2000	Single Pole, Slide-to-OFF	120V, 2000W	Wide
<input type="checkbox"/> CD2003P	Single Pole/3-Way, Preset	120V, 2000W	Wide
<input type="checkbox"/> CDLV700	Single Pole, Slide-to-OFF	120V, 700VA	Narrow
<input type="checkbox"/> CDLV703P	Single Pole/3-Way, Preset	120V, 700VA	Narrow
<input type="checkbox"/> CDLV1100	Single Pole, Slide-to-OFF	120V, 1100VA	Narrow
<input type="checkbox"/> CDLV1103P	Single Pole/3-Way, Preset	120V, 1100VA	Narrow
<input type="checkbox"/> CDLV1600	Single Pole, Slide-to-OFF	120V, 1600VA	Wide
<input type="checkbox"/> CDLV1603P	Single Pole/3-Way, Preset	120V, 1600VA	Wide

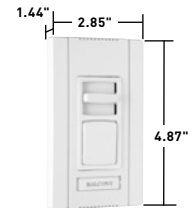

**CD703PW
Narrow**

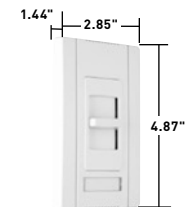

**CD1100W
Narrow**

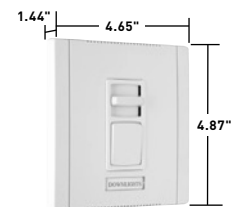

**CD1603PW
Wide**

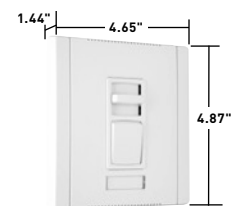

**CDLV1103PW
Wide**

Performance

Electrical

Supply Voltage: 120VAC 60Hz

Maximum Load: Up to rating of device (including derating)

Environment

Ambient Temperature: Between 0° and 40°C

Humidity: Less than 95% non-condensing

Mechanical

Aluminum Heat Sink: Thermoplastic enclosure, wall plate, and ganging parts

Materials

Back Body: Thermoplastic

Spacers: Thermoplastic

Front Body: Thermoplastic

Heat Sink/Strap: Aluminum

Wall Plate: Thermoplastic

Screws: Plated Steel

End Caps: Thermoplastic

Project
Location/Type



TECHNICAL SPECIFICATIONS

Titan® Series Incandescent & Magnetic Low-Voltage

De-Rating for Multi-Gang Installations

DIMMER CATALOG NO.	1-GANG INSTALLATION	FINS: NOT REMOVED		FINS: REMOVED	
		2-GANG INSTALLATION	3- OR MORE GANG INSTALLATION	2-GANG INSTALLATION	3- OR MORE GANG INSTALLATION
CD700	700W	700W	700W	700W	700W
CDLV700	700VA	700VA	700VA	700VA	700VA
CD703P	700W	700W	700W	700W	700W
CDLV703P	700VA	700VA	700VA	700VA	700VA
CD1100	1100W	1100W	1000W	1000W	900W
CDLV1100	1100VA	1100VA	1000VA	1000VA	850VA
CD1103P	1100W	1100W	1000W	1000W	950W
CDLV1103P	1100VA	1100VA	1000VA	1000VA	850VA
CD1600	1600W	1600W	1600W	1600W	1550W
CDLV1600	1600VA	1600VA	1600VA	1600VA	1550VA
CD1603P	1600W	1600W	1600W	1600W	1550W
CDLV1603P	1600VA	1600VA	1600VA	1600VA	1550VA
CD2000	2000W	2000W	2000W	—	—
CD2003P	2000W	2000W	2000W	—	—

Wall Box Gang Requirements

1. Choose fin style (not removed or removed).
2. Select the column for the number of narrow dimmers to be installed.
3. Select the row for the number of wide dimmers to be installed.
4. The number at the intersection of the selected column and row indicates the number of wall box gangs required.

FINS: NOT REMOVED								FINS: NOT REMOVED							
WIDE DIMMERS	NARROW DIMMERS							WIDE DIMMERS	NARROW DIMMERS						
	0	1	2	3	4	5	6		0	1	2	3	4	5	6
0	0	1	1+1*	4	4+1*	7	7+1*	0	0	1	2	3	4	5	6
1	1	3	5	6	8	9	11	1	1	3	4	5	6	7	8
2	4	5	7	8	10	11	13	2	3	4	5	6	7	8	9
3	6	8	9	11	12	14	15	3	5	6	7	8	9	10	11
4	9	10	12	13	15	16		4	7	8	9	10	11	12	13
5	11	13	14	16				5	9	10	11	12	13	14	15
6	14	15						6	11	12	13	14	15	16	17

*Refer to instruction sheets for exact placement of boxes for even number of narrow dimmers.

Project
Location/Type

TECHNICAL SPECIFICATIONS

Titan® Series Fluorescent 2, 3 & 4 Wire



Typical Specifications

Manufacturer's Identification: Wattstopper® CDFB5

Description: Fluorescent Dimmer

Type: Single Pole 2 Wire

Rating: 5A, 120V

3rd Party Compliance: cULus Listed, File Number E95219 Standard UL1472 Solid State Dimming Controls, Standard C22.2 No. 184-1; File Number E109655 Standard UL1917 Solid State Fan Controls, Standard C22.2 No. 156. California Title 24 Compliant. Conforms to NEMA WD-1 and WD-6.

CATALOG NUMBER	DESCRIPTION	RATINGS	NARROW OR WIDE
<input type="checkbox"/> CDFB5	2 Wire, Electronic, Single Pole, Slide-to-OFF	5A, 120V	Narrow
<input type="checkbox"/> CDFB8	2 Wire, Electronic, Single Pole, Slide-to-OFF	8A, 120V	Narrow
<input type="checkbox"/> CDFB10	2 Wire, Electronic, Single Pole, Slide-to-OFF	10A, 120V	Wide
<input type="checkbox"/> CDFB16	2 Wire, Electronic, Single Pole, Slide-to-OFF	16A, 120V	Wide
<input type="checkbox"/> CDFB7277	2 Wire, Electronic, Single Pole, Slide-to-OFF	7A, 277V	Wide
<input type="checkbox"/> CDFB10277	2 Wire, Electronic, Single Pole, Slide-to-OFF	10A, 277V	Wide
<input type="checkbox"/> CDFB53P	2 Wire, Electronic, Single Pole/3-Way, Preset	5A, 120V	Narrow
<input type="checkbox"/> CDFB83P	2 Wire, Electronic, Single Pole/3-Way, Preset	8A, 120V	Narrow
<input type="checkbox"/> CDFB103P	2 Wire, Electronic, Single Pole/3-Way, Preset	10A, 120V	Wide
<input type="checkbox"/> CDFB163P	2 Wire, Electronic, Single Pole/3-Way, Preset	16A, 120V	Wide
<input type="checkbox"/> CDFB73P277	2 Wire, Electronic, Single Pole/3-Way, Preset	7A, 277V	Wide
<input type="checkbox"/> CDFB103P277	2 Wire, Electronic, Single Pole/3-Way, Preset	10A, 277V	Wide
<input type="checkbox"/> CD3FB16	3 Wire, Electronic, Single Pole, Slide-to-OFF	16A, 120V	Narrow
<input type="checkbox"/> CD3FB163P	3 Wire, Electronic, Single Pole/3-Way, Preset	16A, 120V	Narrow
<input type="checkbox"/> CD3FB10277	3 Wire, Electronic, Single Pole, Slide-to-OFF	10A, 277V	Narrow
<input type="checkbox"/> CD3FB103P277	3 Wire, Electronic, Single Pole/3-Way, Preset	10A, 277V	Narrow
<input type="checkbox"/> CD4FB*	4 Wire, Electronic, Single Pole, Slide-to-OFF	24VDC	Narrow
<input type="checkbox"/> CD4FB3P*	4 Wire, Electronic, Single Pole/3-Way, Preset	24VDC	Narrow
<input type="checkbox"/> CD4FBL	4 Wire, Electronic, Single Pole/3-Way, Preset	0-10V	Narrow
<input type="checkbox"/> CD4FBL3P	4 Wire, Electronic, Single Pole/3-Way, Preset	0-10V	Narrow

*4 Wire Dimmers require BZ50 Power Pack, refer to Technical Specifications Page U-168.

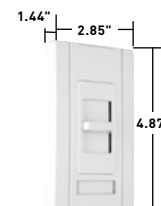

Narrow

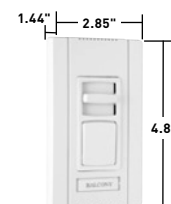

Narrow Preset

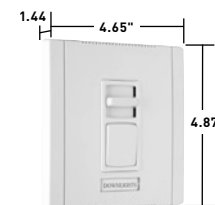

Wide Preset

Performance

Electrical

Supply Voltage: 2 & 3 Wire – 120VAC or 277VAC, 60Hz
4 Wire – 24VDC Class Two Wiring

Maximum Load: Up to rating of device (including de-rating)

Environment

Ambient Temperature: Between 0° and 40°C

Humidity: Less than 95% non-condensing

Mechanical

Aluminum Heat Sink: Thermoplastic enclosure, wall plate, and ganging parts

Materials

Back Body: Thermoplastic

Spacers: Thermoplastic:

Front Body: Thermoplastic

Heat Sink/Strap: Aluminum

Wall Plate: Thermoplastic

Screws: Plated Steel:

End Caps: Thermoplastic

Project
Location/Type



TECHNICAL SPECIFICATIONS

Titan® Series Fluorescent 2, 3 & 4 Wire

De-Rating for Multi-Gang Installations

DIMMER CATALOG NO.	1-GANG INSTALLATION	FINS: NOT REMOVED		FINS: REMOVED	
		2-GANG INSTALLATION	3- OR MORE GANG INSTALLATION	2-GANG INSTALLATION	3- OR MORE GANG INSTALLATION
CDFB5	5A	5A	5A	5A	5A
CDFB8	8A	8A	8A	7.7A	6.3A
CDFB53P	5A	5A	5A	5A	5A
CDFB83P	8A	8A	8A	7.7A	6.3A
CDFB10	10A	10A	10A	10A	10A
CDFB16	16A	16A	16A	—	—
CDFB7277	7A	7A	7A	7A	7A
CDFB10277	10A	10A	10A	10A	10A
CDFB103P	10A	10A	10A	10A	10A
CDFB163P	16A	16A	16A	—	—
CDFB73P277	7A	7A	7A	7A	7A
CDFB103P277	10A	10A	10A	10A	10A
CD3FB16	16A	16A	16A	16A	16A
CD3FB163P	16A	16A	16A	16A	16A
CD3FB10277	10A	10A	10A	10A	10A
CD3FB103P277	10A	10A	10A	10A	10A
CD4FB	DO NOT EXCEED 60 BALLASTS				
CD4FB3P	DO NOT EXCEED 60 BALLASTS				

2 & 4 Wire Electronic Fluorescent Dimmer Ballast Compatibility

COMPATIBLE CATALOG NUMBER	VOLTAGE	BALLAST MANUFACTURER	MODEL & SERIES
2 WIRE BALLAST COMPATABILITY			
CDFB5 CDFB8 CDFB53P CDFB83P CDFB10 CDFB16 CDFB103P CDFB163P	120VAC 60Hz	Advance	REZ-132-SC, REZ-2S32-SC, REZ-3S32-SC, REZ-154, REZ-2554, REZ-1Q18-M2, REZ-2Q18-M2, REZ-1T42-M2, REZ-2T42-M3, REZ-1TTS40/REZ-1TTS40-SC, REZ-2TTS40/REZ-2TTS40-SC, IEZ-2S24-D, REB-2S26-M1-LS-DIM/REB-2S26-M1-BS-DIM
		Lutron	2W-T426-120-1-S, 2W-T426-120-2-S, 2W-T432-120-1-S, 2W-T432-120-2-S, 2W-T832-120-1-S, 2W-T832-120-2-S
		Sylvania/Osram	
CDFB7277 CDFB10277 CDFB73P277 CDFB103P277	277VAC 60Hz	Advance	VEZ-132-SC, VEZ-2S32-SC, VEZ-3S32-SC, VEZ-154, VEZ2S54, VEZ-1Q18-M2, VEZ-2Q18-M2, VEZ-2T42-M3, VEZ-1TTS40/VEZ-1TTS40-SC, VEZ-2TTS40/VEZ-2TTS40-SC, IEZ-2S24-D
		Sylvania/Osram	QTP1x32T8/UNV DIM, QTP2x32T8/UNV DIM, QTP3x32T8/UNV DIM, QTP4x32T8/UNV DIM
4 WIRE BALLAST COMPATABILITY*			
CD4FB CD4FB3 CD4FBL3P CD4FBL	0-10V	Advance Transformer	Mark 7, Xitanium, IZT, RZT, VZT, LED120
		Lutron	Eco-10 TVE
		Sylvania/Osram	Quicktronic Powersense, Helios, Optotronic QTP, QT, OT
		Universal	SuperDim, Ballastar ES, B132, B232, B332, B432
		GE	T8 Dimming Ballasts B132, B232, B332

* 0-10V Dimmers comply with IEC standard 60929 Annex E. Additional 0-10V ballasts and/or LED drivers may also be compatible with this control. Contact Legrand to verify compatibility.

Project
Location/Type

TECHNICAL SPECIFICATIONS

Titan® Series Fluorescent 2, 3 & 4 Wire



3 Wire Electronic Fluorescent Dimmer Ballast Compatibility

COMPATIBLE CATALOG NUMBER	VOLTAGE	BALLAST MANUFACTURER	COMPATIBLE DIMMER BALLAST MODEL & SERIES				
			1% HI-LUME, HI-LUME 3D		5% COMPACT SE	10% ECO-10	
2 WIRE BALLAST COMPATABILITY							
CD3FB16 CD3FB163P	120VAC 60Hz	Lutron	HL3-T426-120-1-S	FDB-3627-120-3	FDB-T418-120-1-S	E3-T514C-120-1	ECO-T540-120-1
			HL3-T432-120-1-S	FDB-4827-120-1	FDB-T418-120-2-S	E3-T514C-120-2	ECO-T540-120-2
			FDB-T524-120-1	FDB-4827-120-2	FDB-T426-120-1-S	E3-T521C-120-1	ECO-T540-120-3
			FDB-T524-120-2	FDB-4827-120-3	FDB-T426-120-2-S	E3-T521C-120-2	ECO-T550-120-1
			FDB-T539-120-1	FDB-6027-120-1	FDB-T418-120-1-S	ECO-T528-120-1	ECO-T550-120-2
			FDB-T539-120-2	FDB-6027-120-2	FDB-T418-120-2-S	ECO-T528-120-2	ECO-T817-120-1
			FDB-T554-120-1	FDB-7280-120-1	FDB-T426-120-1-S	ECO-T524-120-1	ECO-T817-120-2
			FDB-T554-120-2	FDB-8480-120-1	FDB-T426-120-2-S	ECO-T524-120-2	ECO-T817-120-3
			FDB-2427-120-1	FDB-9680-120-1	FDB-T432-120-1-S	ECO-T5H39-120-1	ECO-T825-120-1
			FDB-2427-120-2	H3DT832CUNV110	FDB-T432-120-2-S	ECO-T5H39-120-2	ECO-T825-120-2
			FDB-2427-120-3	H3DT832CUNV117	FDB-T442-120-1-S	ECO-T554-120-1	ECO-T832-120-1-L
			FDB-3627-120-1	H3DT832CUNV210	FDB-T442-120-2-S	ECO-T554-120-2	ECO-T832-120-1-T
			FDB-3627-120-2	H3DT832CUNV217	FDB-1643-120-1	ECO-T539-120-1	ECO-T832-120-2-L
					FDB-1643-120-2	ECO-T539-120-2	ECO-T832-120-2-T
					FDB-1643-120-3	ECO-T539-120-3	ECO-T832-120-3
		FDB-2227-120-1					
		FDB-2227-120-2					
		FDB-2227-120-3					
		FDB-2243-120-1					
		FDB-2243-120-2					
CD3FB10277 CD3FB103P277	277VAC 60Hz	Lutron	HL3-T426-277-1-S	FDB-3627-277-2	FDB-T418-277-1-S	E3-T514C-277-1	ECO-T540-277-3
			HL3-T432-277-1-S	FDB-3627-277-3	FDB-T418-277-2-S	E3-T514C-277-2	ECO-T550-277-1
			FDB-T524-277-1	FDB-4827-277-1	FDB-T426-277-1-S	E3-T521C-277-1	ECO-T550-277-2
			FDB-T524-277-2	FDB-4827-277-2	FDB-T426-277-2-S	E3-T521C-277-2	ECO-T817-277-1
			FDB-T539-277-1	FDB-4827-277-3	FDB-T418-277-1-S	ECO-T528-277-1	ECO-T817-277-2
			FDB-T539-277-2	FDB-6027-277-1	FDB-T418-277-2-S	ECO-T528-277-2	ECO-T817-277-3
			FDB-T554-277-1	FDB-6027-277-2	FDB-T426-277-1-S	ECO-T524-277-1	ECO-T825-277-1
			FDB-T554-277-2	H3DT832CUNV110	FDB-T426-277-2-S	ECO-T524-277-2	ECO-T825-277-2
			FDB-2427-277-1	H3DT832CUNV117	FDB-T432-277-1-S	ECO-T5H39-277-1	ECO-T817-277-1
			FDB-2427-277-2	H3DT832CUNV210	FDB-T432-277-2-S	ECO-T5H39-277-2	ECO-T832-277-1-L
			FDB-2427-277-3	H3DT832CUNV217	FDB-T442-277-1-S	ECO-T554-277-1	ECO-T832-277-1-T
			FDB-3627-277-1		FDB-T442-277-2-S	ECO-T554-277-2	ECO-T832-277-1
					FDB-1643-277-1	ECO-T539-277-1	E3-T832C-277-2
					FDB-1643-277-2	ECO-T539-277-2	ECO-T832-277-2-L
					FDB-1643-277-3	ECO-T539-277-3	ECO-T832-277-2-T
		FDB-2227-277-1	ECO-T540-277-1	ECO-T832-277-2			
		FDB-2227-277-2	ECO-T540-277-2	ECO-T832-277-3			
		FDB-2227-277-3					
		FDB-2243-277-1					
		FDB-2243-277-2					

Wall Box Gang Requirements

1. Choose fin style (not removed or removed).
2. Select the column for the number of narrow dimmers to be installed.
3. Select the row for the number of wide dimmers to be installed.
4. The number at the intersection of the selected column and row indicates the number of wall box gangs required.

FINS: NOT REMOVED								FINS: REMOVED							
WIDE DIMMERS	NARROW DIMMERS							WIDE DIMMERS	NARROW DIMMERS						
	0	1	2	3	4	5	6		0	1	2	3	4	5	6
0	0	1	1+1*	4	4+1*	7	7+1*	0	0	1	2	3	4	5	6
1	1	3	5	6	8	9	11	1	1	3	4	5	6	7	8
2	4	5	7	8	10	11	13	2	3	4	5	6	7	8	9
3	6	8	9	11	12	14	15	3	5	6	7	8	9	10	11
4	9	10	12	13	15	16		4	7	8	9	10	11	12	13
5	11	13	14	16				5	9	10	11	12	13	14	15
6	14	15						6	11	12	13	14	15	16	17

*Refer to instruction sheets for exact placement of boxes for even number of narrow dimmers.

Project
Location/Type



TECHNICAL SPECIFICATIONS

Incandescent Wide Slide Dimmers 120VAC, 60 Hz

Typical Specifications

Incandescent dimmer shall be UL Listed/CSA Certified Wattstopper® Specification Grade, with full range solid-state circuitry that shall provide even control by means of a slide mechanism. Preset lighting levels may be maintained by means of a separate ON/OFF switch. Dimmers shall fit in standard single gang wall boxes. California Title 24 Compliant. Conforms to NEMA WD-1 and WD-6.

CATALOG NUMBER	DESCRIPTION	RATINGS	NARROW OR WIDE
<input type="checkbox"/> WS700TC	Single Pole, Slide to OFF	120V, 700W	Ivory/White/Lt. Almond
<input type="checkbox"/> WS700W	Single Pole, Slide to OFF	120V, 700W	White
<input type="checkbox"/> WS703PTC	Preset, Single Pole/3-Way	120V, 700W	Ivory/White/Lt. Almond
<input type="checkbox"/> WS703PW	Preset, Single Pole/3-Way	120V, 700W	White
<input type="checkbox"/> WS1100TC	Single Pole, Slide to OFF	120V, 1100W	Ivory/White/Lt. Almond
<input type="checkbox"/> WS1100W	Single Pole, Slide to OFF	120V, 1100W	White
<input type="checkbox"/> WS1103PTC	Preset, Single Pole/3-Way	120V, 1100W	Ivory/White/Lt. Almond
<input type="checkbox"/> WS1103PW	Preset, Single Pole/3-Way	120V, 1100W	White

Features

- Maximum ratings are for continuous full load.
- Preset models include ON/OFF rocker switch that allows ON/OFF switching without disturbing preset intensity levels.
- 700 Watt models may be ganged without de-rating.
- RFI suppression built-in.
- Installs in NEMA standard single-gang wall boxes.
- Screw-pressure-plate back and side wire.
- Package comes with three face colors – Ivory, White, Light Almond (TC).
- White only option also available (W).
- Interchangeable faces available in four colors (sold separately, see Page 0-13).

Performance

Electrical

Voltage: 120VAC 60 Hz
 Rated Load: (See Above) Incandescent Only
 Filtering: Radio Frequency Interference Filtering
 Construction: Printed Circuit Board for Reliability
 3rd Party Compliance: UL Listed, CSA Certified

Physical

Size: One Gang
 Heat Sink: Black Anodized Aluminum Mounting Strap
 Wiring: 6" Color-Coded Leads Pre-Stripped

Environmental

Application: Indoor Use Only

Materials

Front Cover and Knob: Flame Retardant UL94 V0, UV Stable Polycarbonate
 Back Body: Unbreakable ABS

Accessories

Installation and Operating Instructions Provided

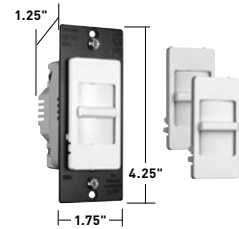

WS700TC

Shown with the Three Interchangeable Faces
 All 1100W versions are 2.50" W

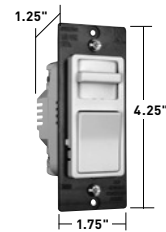

Preset Models

Project
Location/Type

TECHNICAL SPECIFICATIONS

Magnetic Low-Voltage Wide Slide Dimmers 120VAC, 60 Hz



Typical Specifications

Low-voltage dimmer shall be UL Listed/CSA Certified Wattstopper® Specification Grade, with full range solid-state circuitry that shall provide even control by means of a slide mechanism. Preset lighting levels may be maintained by means of a separate ON/OFF switch. Dimmers shall fit in standard single gang wall boxes. California Title 24 Compliant. Conforms to NEMA WD-1 and WD-6.

CATALOG NUMBER	DESCRIPTION	RATINGS	NARROW OR WIDE
☐ WSLV700TC	Single Pole	120V, 700VA	Ivory/White/Lt. Almond
☐ WSLV700W	Single Pole	120V, 700VA	White
☐ WSLV703PTC	Preset, Single Pole/3-Way	120V, 700VA	Ivory/White/Lt. Almond
☐ WSLV703PW	Preset, Single Pole/3-Way	120V, 700VA	White

Features

- Maximum ratings are for continuous full load.
- 700VA dimmers may be ganged without de-rating.
- Installs in NEMA standard single-gang wall boxes.
- Preset models include ON/OFF rocker switch that allows ON/OFF switching without disturbing preset intensity levels.
- RFI suppression built-in.
- Screw-pressure-plate back and side wire.
- Package comes with three face colors – Ivory, White, Light Almond (TC).
- White only option also available (W).
- Interchangeable faces available in four colors (sold separately, see Page 0-13).

Performance

Electrical

Voltage:	120VAC 60 Hz
Rated Load:	[See Above] Low-Voltage Only
Filtering:	Radio Frequency Interference Filtering
Construction:	Printed Circuit Board for Reliability
3rd Party Compliance:	UL Listed, CSA Certified

Physical

Size:	One Gang
Heat Sink:	Black Anodized Aluminum Mounting Strap
Wiring:	6" Color-Coded Leads Pre-Stripped

Environmental

Application:	Indoor Use Only
--------------	-----------------

Materials

Front Cover and Knob:	Flame Retardant UL94 V0, UV Stable Polycarbonate
Back Body:	Unbreakable ABS

Accessories

Installation and Operating Instructions Provided

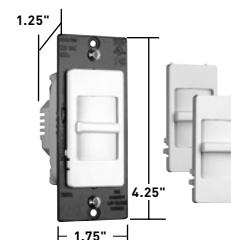

WSLV700TC

Shown with the Three Interchangeable Faces

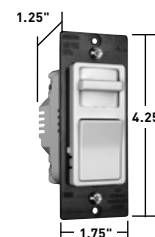

WSLV703PW

Project
Location/Type



TECHNICAL SPECIFICATIONS

Incandescent Rotary Dimmers 120VAC, 60 Hz

Typical Specifications

Incandescent dimmer shall be UL Listed/CSA Certified Wattstopper® Specification Grade, with full range solid-state circuitry giving even control by means of rotary action and positive ON/OFF switching. All dimmers shall fit standard single gang wall boxes. California Title 24 Compliant. Conforms to NEMA WD-1 and WD-6.

CATALOG NUMBER	DESCRIPTION	RATED LOAD
<input type="checkbox"/> R600V	Rotary Dial ON/Dial OFF Incandescent Dimmer, Single Pole Rotate to OFF	600W
<input type="checkbox"/> R1000V	Rotary Dial ON/Dial OFF Incandescent Dimmer, Single Pole Rotate to OFF	1000W
<input type="checkbox"/> R600P	Rotary Preset Incandescent Dimmer, Single Pole Push ON/Push OFF	600W
<input type="checkbox"/> R603P	Rotary Preset Incandescent Dimmer, 3-Way Push ON/Push OFF	600W
<input type="checkbox"/> R1000P	Rotary Preset Incandescent Dimmer, Single Pole Push ON/Push OFF	1000W
<input type="checkbox"/> R1003P	Rotary Preset Incandescent Dimmer, 3-Way Push ON/Push OFF	1000W

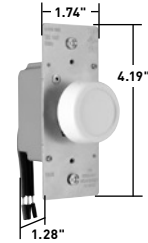
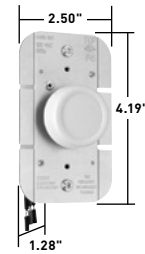
R600WV

R1000WV

Features

- Maximum ratings are for continuous full load.
- Push-ON/OFF rotary switch permits full-range dimming control and switching at any pre-set level.
- Excellent state-of-the-art solid-state electronic circuitry design saves energy and extends bulb life when lighting level is reduced.
- 600V, UL/CSA hook-up wire, multi-stranded, fray-resistant, pre-tinned, 18-gauge wire, insulation rated at 105°C.
- Thick aluminum mounting strap provides heat sink for electronic components.
- Installs in NEMA standard single-gang wall boxes.
- May be ganged without de-rating.
- RFI protected.

Performance

Electrical

Voltage: 120VAC 60 Hz
 Rated Load: 600 Watt Incandescent Only
 Construction: Printed Circuit Board for Reliability
 3rd Party Compliance: UL Listed
 CSA Certified

Controls

Range: Dial with Push On and Off
 Output: Safety Power Off Switch

Physical

Size: Single Gang, No Derating Necessary
 Heat Sink: Aluminum Mounting Strap
 Wiring: 6" Color-Coded Leads Pre-Stripped

Environmental

Application: Indoor Use Only

Materials

Knob: Unbreakable ABS
 Back Body: Unbreakable ABS

Accessories

Twist Wire Connectors: Provided Installation and Operating Instructions: Provided

Project
Location/Type

TECHNICAL SPECIFICATIONS

UTP Outlet Wiring Configurations

UTP Outlet Wiring Configurations

T568A

- Adopted by TIA/EIA and 11801 standards.
- Compatible with one- or two-pair USOC.
- May be used for ISDN.
- Supports Categories 3, 4, 5, 5e, and 6.

Pair ID	PIN Number
T1	5
R1	4
T2	3
R2	6
T3	1
R3	2
T4	7
R4	8

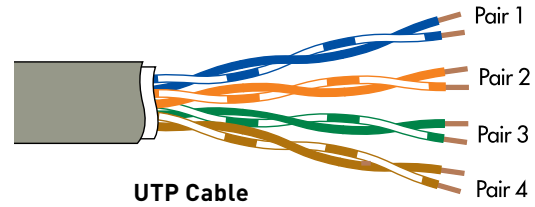

T568B

- Adopted by TIA/EIA and 11801 standards.
- Not compatible with one- or two-pair USOC.
- May be used for ISDN.
- Supports Categories 3, 4, 5, 5e, and 6.

Pair ID	PIN Number
T1	5
R1	4
T2	1
R2	2
T3	3
R3	6
T4	7
R4	8

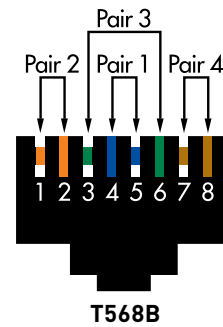
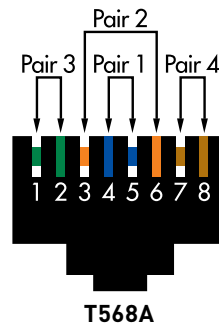

USOC

- Available for 1-, 2-, 3-, or 4-pair systems.
- Maintains pair continuity in 6-position plugs configured with one, two, or three pairs.
- Inferior performance compared to T568A or T568B.
- Not cabling standard compliant.

Pair ID	PIN Number
T1	5
R1	4
T2	3
R2	6
T3	2
R3	7
T4	1
R4	8

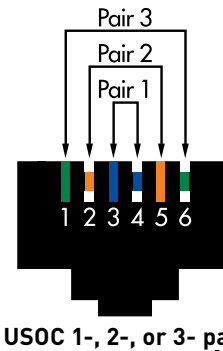
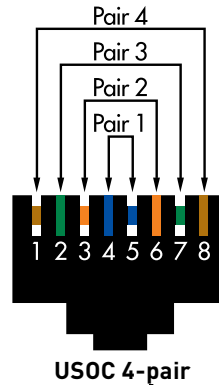

10Base-T/100Base-T

- Eight-position jack, but only two pairs used.

Pair ID	PIN Number
T1	1
R1	2
T2	3
R2	6

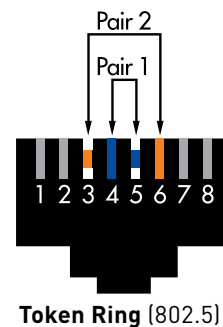
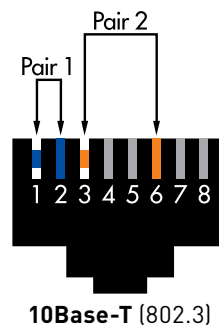

Token Ring

- Uses either a six-position or eight-position jack.
- Eight-position compatible with T568A, T568B, and USOC.
- Six-position compatible with one- or two-pair USOC.

Pair ID	PIN Number
T1	5
R1	4
T2	3
R2	6

10Base-T (802.3)

Token Ring (802.5)

Project
Location/Type

TECHNICAL SPECIFICATIONS

Universal & Six-Pin Wiring Guides & UTP Cabling Installation

Universal Wiring Guide

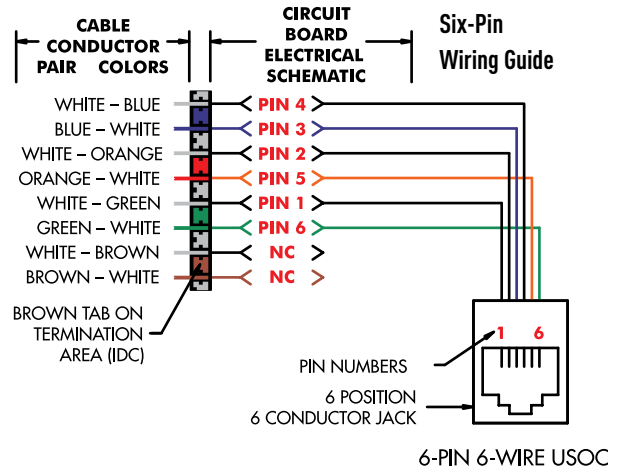
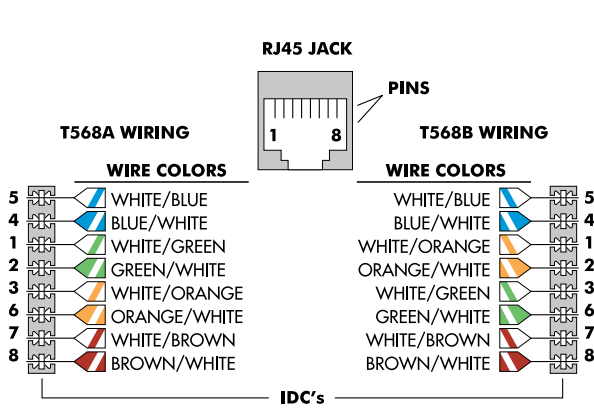

Application Example

In some retrofit applications you may encounter quad-wire. This is the red, green, yellow, and black phone cable that was common in most phone installations before the 90's. Legrand recommends that you remove this cable whenever possible and replace it with Category 5e cable and connectors. If removal is not possible, follow the color-code guidelines below to make connections to jacks bearing current UTP color markings.

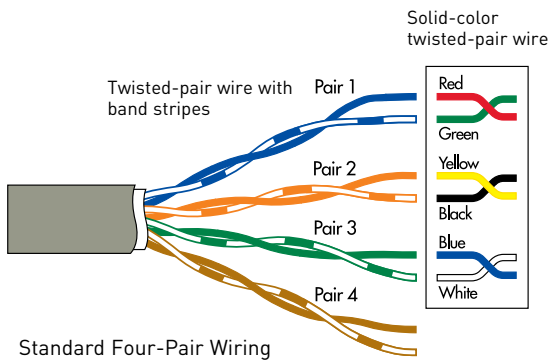

Pair 1	T	White/Blue	Pair 3	T	White/Green
	R	Blue/White		R	Green/White
Pair 2	T	White/Orange	Pair 4	T	White/Brown
	R	Orange/White		R	Brown/White

Basic practices for installing unshielded twisted-pair (UTP) network cabling

Minimize untwisting of twisted pairs.

When making terminations at jack modules, untwist no more than 1/2" for Category 5e cable or above; no more than 1" for Category 3. Untwisting pairs beyond these specifications can increase the risk of failed cable performance testing.

Limit cable bend radius.

Cable should not bend more sharply than four times its diameter. For Category 5e cable or above, that means a minimum bend radius of about one inch. Bending cable to tighter-than-minimum bend radius causes pairs to separate, compromising cable performance.

Observe maximum pulling tension.

Cable is commonly pulled through walls, raceways, and other passageways. No more than 25 pounds of tension should be applied. Excess pulling tension can distort twisted pairs, again posing a threat to performance.

Stay away from high-voltage and electromagnetism.

Avoid running cable in proximity to high-voltage sources or electromagnetic fields, as these can cause interference. Examples include ballasts, electric motors, transformers, and copiers.

Test to ensure performance.

Test completed cabling to ensure that customers get what they're paying for — and to prevent insufficient-performance liability. Test parameters are outlined in TIA/EIA-568-B.1 and vary depending on type of cable.

Project
Location/Type

TECHNICAL SPECIFICATIONS

Wall Plate Specifications



Thermoset Smooth



TP Nylon Smooth

Application

Legrand's broad line of Pass & Seymour® Standard Size Plastic and Metal Wall Plates features the most complete range of types, sizes, colors, and finishes available. Choose from more than 1,900 standard plates in non-combustible thermoset plastic material, self-extinguishing nylon material, screwless polycarbonate material, or attractively finished metal, for residential, commercial, institutional, and industrial applications. All plastic wall plates color match to Pass & Seymour® devices.

3rd Party Compliance

UL Listed, Standard UL514, Cover Plates for Flush-Mounted Wiring Devices.
 Plastic Wall Plates UL File No. E143222.
 Metal Wall Plates UL File No. E143223.
 CSA Certified.

Thermoset Plastic Wall Plates

- Molded of non-combustible mar-proof material.
- Available in "SP" series in Standard, Junior-Jumbo, and Jumbo sizes.
- Seven standard colors available – Ivory, White, Brown, Gray, Black, Red, and Light Almond.
- Individually wrapped with color-matching screws.
- Resistant to discoloration, grease, oil, solvent and moisture.
- Nominal thickness, .070"

Materials

Wall Plate Material: Urea
 Mounting Screws: Metal, oval heads painted to match plate color

TradeMaster® Thermoplastic Wall Plates

- Molded of rugged, practically indestructible self-extinguishing nylon. ("TP" series only.)
- Available in "TP" series, extra 3/16" width and height than Standard size plates; and "TPJ" series, extra 3/16" width and height than Junior-Jumbo size plates.
- Available in Ivory, White, Brown, Gray, Black, Blue, Orange, Red, and Light Almond.
- Preferred for hospital, industrial, institutional, and other high-abuse applications.
- Nominal thickness, .070"

Performance

Mechanical

Mechanical Strength: Exceeds UL514 Bend Test
 Deformation: Exceeds UL514 Corner Peel

Environmental

Chemical-Resistant Flammability: UL94 V2

Materials

Wall Plate Material: .070" Nylon 6
 Wall Plate Finish: Matte
 Mounting Screws: Steel, oval heads painted to match plate color

Project

Location/Type

TECHNICAL SPECIFICATIONS

Wall Plate Specifications



**radiant® Screwless
Polycarbonate
RWP Series**



**302/304
Stainless Steel**



Polished Brass



Aluminum

3rd Party Compliance

UL Listed, Standard UL514, Cover Plates for Flush-Mounted Wiring Devices.

Plastic Wall Plates UL File No. E143222.

Metal Wall Plates UL File No. E143223.

CSA Certified.

Screwless Polycarbonate Wall Plates

- Molded of .065" thick polycarbonate, matte finish.
- One-piece plastic subplate made of polycarbonate.
- Extra 3/8" width and height than Standard size plates.
- Part of the radiant® collection.
- Available in Ivory, White, Brown, Gray, Black, and Light Almond; and two metallic finishes - Nickel, Dark Bronze.

Performance

Flammability: .UL94 V2

Plastic Subplate Material: Polycarbonate

Materials

Wall Plate Material: .065" Polycarbonate

Wall Plate Finish: Matte

Metal Wall Plates

- Constructed of corrosion-resistant stainless steel, brass, aluminum, chrome, brushed bronze or galvanized steel.
- Standard, Jumbo, and Tandem plates available, as well as special Panel plates up to 5-gangs high and 10-gangs wide.
- Packaged in protective film, with finish-matching screws.
- Variety of special plated finishes. Paintable to match plastic plates.
- Can be silk-screened or engraved, and custom punched with over 300 opening styles.

Materials

- Type 302/304 Stainless Steel, non-magnetic, .032" nominal thickness, brushed finish. This alloy contains 18% chromium and 8% nickel for superior resistance to corrosion. Recommended for use in food processing plants, dairies, chemical plants, and other industrial, institutional, and commercial applications where corrosive atmospheres exist.
- Type 430 Stainless Steel, magnetic, .032" nominal thickness, brushed finish. Less corrosion-resistant than Type 302/304, but ideal for general service in high abuse applications in industrial plants, commercial, and institutional buildings.
- Chrome and Polished Brass, .040" thick. 70% copper, 30% zinc alloy gives warm, appealing finish to modern decor as well as retrofit applications. Lacquered to prevent corrosion.
- Aluminum, .040" thick. Lustrous satin finish. Lacquered to prevent corrosion.
- Galvanized Steel. Used only for Handy Box Plates.
- Brushed Bronze, .040" thick. 90% copper, 10% zinc. Lacquered to prevent corrosion.

Project
Location/Type

TECHNICAL SPECIFICATIONS

Wall Plate Dimensions

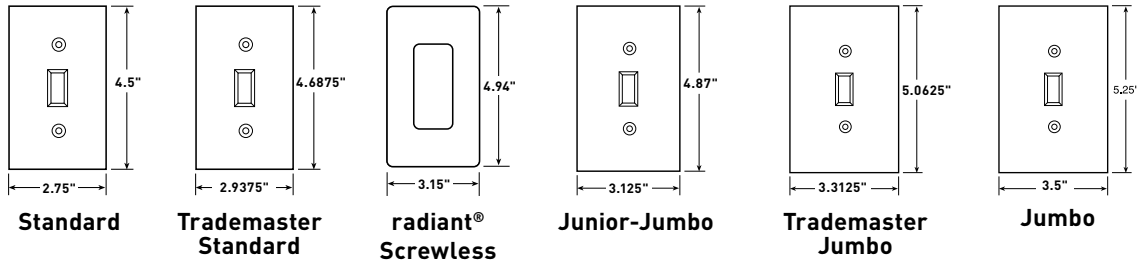

Standard Size Wall Plates

- Standard size wall plates for all applications.
- Best fit for surface mount boxes.
- Available in plastic and metal only.

Dimensions

1 gang	2.75" x 4.5"
2 gang	4.56" x 4.5"
3 gang	6.375" x 4.5"
4 gang	8.125" x 4.5"
5 gang	10" x 4.5"
6 gang	11.812" x 4.5"
7 gang	13.62" x 4.5"
8 gang	15.44" x 4.5"

TradeMaster[®] Wall Plates

- Extra 3/16" width and height than Standard size wall plates.
- Provide better sheet rock coverage with standard size appearance.
- Available in unbreakable nylon 6 construction only.
- Screws pre-installed in the duplex, toggle and decorator single gang plates.

Dimensions

1 gang	2.9375" x 4.6875"
2 gang	4.75" x 4.6875"
3 gang	6.563" x 4.6875"
4 gang	8.375" x 4.6875"
5 gang	10.188" x 4.6875"
6 gang	12" x 4.6875"

radiant[®] Screwless Polycarbonate Wall Plates

- Available in decorator-style openings.
- Extra 3/8" width and height than Standard size wall plates.
- Provide better sheet rock coverage with standard size appearance.
- Molded of .065" thick polycarbonate.
- One-piece plastic subplate.
- Available in 2 metallic and 6 standard colors.

Wall Plate Dimensions

1 gang	3.15" x 4.94"
2 gang	4.96" x 4.94"
3 gang	6.77" x 4.94"
4 gang	8.59" x 4.94"
5 gang	10.40" x 4.94"
6 gang	12.21" x 4.94"

Subplate Dimensions

1 gang	1.81" x 4.78" x .15"
2 gang	3.62" x 4.78" x .15"
3 gang	5.44" x 4.78" x .15"
4 gang	7.25" x 4.78" x .15"
5 gang	9.06" x 4.78" x .15"
6 gang	10.87" x 4.78" x .15"

Junior-Jumbo Wall Plates

- Extra 3/8" width and height than Standard size wall plates.
- Additional coverage for sheet rock gaps.
- Available in plastic and metal only.

Dimensions

1 gang	3.125" x 4.87"
2 gang	4.93" x 4.87"
3 gang	6.75" x 4.87"
4 gang	8.56" x 4.87"

TradeMaster Jumbo Wall Plates

- Extra 3/16" width and height than Junior-Jumbo size wall plates.
- Provide additional coverage for sheet rock gaps, matching the appearance of the TradeMaster Plates.
- Available in unbreakable nylon 6 construction only.
- Screws pre-installed in the duplex, toggle, and decorator-style single gang plates.

Dimensions

1 gang	3.3125" x 5.0625"
2 gang	5.125" x 5.0625"
3 gang	6.9375" x 5.0625"
4 gang	8.75" x 5.0625"

Jumbo Wall Plates

- Extra 3/4" width and height than Standard size wall plates.
- Largest size wall plates to cover larger wall damage.
- Available in plastic and metal only.

Dimensions

1 gang	3.5" x 5.25"
2 gang	5.31" x 5.25"
3 gang	7.12" x 5.25"
4 gang	8.93" x 5.25"

Project
Location/Type

TECHNICAL SPECIFICATIONS

radiant® Tamper-Resistant AFCI Receptacles

2 Pole, 3 Wire Grounding 15 & 20A, 125VAC

Typical Specifications

Manufacturer's Identification: Pass & Seymour AF152TR

Description: radiant Tamper-Resistant Outlet Branch Circuit AFCI Receptacle

Type: 2 Pole, 3 Wire Grounding

Rating: 20A, 125VAC Feed Thru; 15 or 20A, 125VAC Face

3rd Party Compliance: cULus Listed, File Number E483695; Standard UL498 Tamper-Resistant, Attachment Plugs and Receptacles; UL1699A OBC AFCI, Federal Specification WC596. Standard CSA-C22.2 No. 42, General Use Receptacles, CSA-C22.2 No. 270-14, conforms to NEMA WD-1 and WD-6.

CATALOG NUMBER	COLOR	RATING	NEMA CONFIG. NO.
<input type="checkbox"/> AF152TRW	White	15A 125V	5-15R
<input type="checkbox"/> AF152TRI	Ivory	15A 125V	5-15R
<input type="checkbox"/> AF152TR	Brown	15A 125V	5-15R
<input type="checkbox"/> AF152TRBK	Black	15A 125V	5-15R
<input type="checkbox"/> AF152TRLA	Lt. Almond	15A 125V	5-15R
<input type="checkbox"/> AF152TRGRY	Gray	15A 125V	5-15R
<input type="checkbox"/> AF202TRW	White	20A 125V	5-20R
<input type="checkbox"/> AF202TRI	Ivory	20A 125V	5-20R
<input type="checkbox"/> AF202TR	Brown	20A 125V	5-20R
<input type="checkbox"/> AF202TRBK	Black	20A 125V	5-20R
<input type="checkbox"/> AF202TRLA	Lt. Almond	20A 125V	5-20R
<input type="checkbox"/> AF202TRGRY	Gray	20A 125V	5-20R
<input type="checkbox"/> AF202DFW	White	20A 125V	—
<input type="checkbox"/> AF202DFI	Ivory	20A 125V	—
<input type="checkbox"/> AF202DFLA	Lt. Almond	20A 125V	—

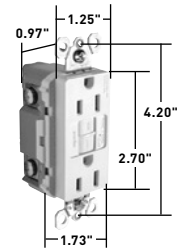

AF152TRW

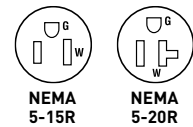

All AFCIs are Fed Spec, FSUL Listed. UL and CSA Listed.

Performance

Electrical

Dielectric:	Withstands 1500V minimum
Frequency:	60 Hz
Voltage:	125VAC
Voltage Range:	102-132 VAC

Mechanical

Indicator Light (LED):	Red, On when GFCI is tripped
Terminal Identification:	Terminals identified in accordance with UL498 (Hot, White, Green)
Product Identification:	Ratings are a permanent part of device

Safety

SafeLock™ Protection:	If critical components are damaged and protection is lost, power to the receptacle is disconnected
-----------------------	--

Environmental

Operating Temperature:	-35°C to +66°C
Maximum Humidity:	95%
Flammability	UL94 V2

Materials

Face:	Nylon	Hex Head Grounding Screw:	Steel (Green)
Body:	Thermoplastic	Flat Head Mounting Screws:	Zinc-Plated Steel
Contacts:	.03" Brass (.8)	Test/Reset Buttons:	Nylon
Mounting Straps:	.05" Zinc-Plated Steel (1.3)	Tamper-Resistant Shutter:	Thermoplastic
Terminal Screws:	Steel #8 - 32	Auto-Ground Clip:	Brass Alloy C260

TECHNICAL SPECIFICATIONS

Project
Location/Type

TECHNICAL SPECIFICATIONS

the
radiant®
collection

radiant® Tamper-Resistant Dual Function AFCI/GFCI Receptacles

2 Pole, 3 Wire Grounding 15 & 20A, 125VAC

Typical Specifications

Manufacturer's Identification: Pass & Seymour AFGF152TR

Description: radiant® Tamper-Resistant Dual Function AFCI/GFCI Receptacles

Type: 2 Pole, 3 Wire Grounding

Rating: 20A, 125VAC Feed Thru; 15 or 20A, 125VAC Face

3rd Party Compliance: cULus Listed, File Number E483695; Standard UL498 Tamper-Resistant, Attachment Plugs and Receptacles; UL943 GFCI, UL1699A OBC AFCI, Federal Specification WC596. Standard CSA-C22.2 No. 42, General Use Receptacles, CSA-C22.2 No. 270-14, conforms to NEMA WD-1 and WD-6.

CATALOG NUMBER	COLOR	RATING	NEMA CONFIG. NO.
<input type="checkbox"/> AFGF152TRW	White	15A 125V	5-15R
<input type="checkbox"/> AFGF152TRI	Ivory	15A 125V	5-15R
<input type="checkbox"/> AFGF152TR	Brown	15A 125V	5-15R
<input type="checkbox"/> AFGF152TRBK	Black	15A 125V	5-15R
<input type="checkbox"/> AFGF152TRLA	Lt. Almond	15A 125V	5-15R
<input type="checkbox"/> AFGF152TRGRY	Gray	15A 125V	5-15R
<input type="checkbox"/> AFGF202TRW	White	20A 125V	5-20R
<input type="checkbox"/> AFGF202TRI	Ivory	20A 125V	5-20R
<input type="checkbox"/> AFGF202TR	Brown	20A 125V	5-20R
<input type="checkbox"/> AFGF202TRBK	Black	20A 125V	5-20R
<input type="checkbox"/> AFGF202TRLA	Lt. Almond	20A 125V	5-20R
<input type="checkbox"/> AFGF202TRGRY	Gray	20A 125V	5-20R

All AFCI/GFCI are Fed Spec, FSUL listed and cULus listed.

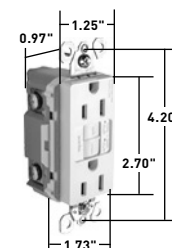

AFGF152TRW

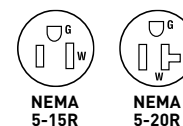

Performance

Electrical

Dielectric: Withstands 1500V minimum

Frequency: 60 Hz

Voltage: 125VAC

Voltage Range: 102-132 VAC

Mechanical

Indicator Light (LED): Red, On when GFCI is tripped. Flashes to indicate GFCI has failed self-test and device should be replaced

Terminal Identification: Terminals identified in accordance with UL498 (Hot, White, Green)

Product Identification: Ratings are a permanent part of device

Safety

Self-Test: Self-tests every three seconds

SafeLock™ Protection: If critical components are damaged and protection is lost, power to the receptacle is disconnected

Environmental

Operating Temperature: -35°C to +66°C

Maximum Humidity: 95%

Flammability: UL94 V2

Materials

Face:	Nylon	Hex Head Grounding Screw:	Steel (Green)
Body:	Thermoplastic	Flat Head Mounting Screws:	Zinc-Plated Steel
Contacts:	.03" Brass (.8)	Test/Reset Buttons:	Nylon
Mounting Straps:	.05" Zinc-Plated Steel (1.3)	Tamper-Resistant Shutter:	Thermoplastic
Terminal Screws:	Steel #8 - 32	Auto-Ground Clip:	Brass Alloy C260

Project
Location/Type

TECHNICAL SPECIFICATIONS

U-184

GLOSSARY OF TERMS

A.C. (Alternating Current) – An electric current, such as normal household current, that reverses direction in a circuit at regular intervals.

A.C. Only – A device for use on alternating current (A.C.) circuits only.

Active Equipment – Energized equipment used for receiving or transmitting analog or digital signals (e.g., hubs, routers, PBXs, etc.).

Adapter – An accessory used for interconnecting non-mating devices or converting an existing device to a new or modified use.

Administration – The method for labeling, documentation, and usage needed to implement moves, additions, and changes to a telecommunications infrastructure.

AFCI – An arc-fault circuit interrupter is a device intended to provide protection from the effects of arc faults.

Air Gap Switch – A mechanical switch which is capable of creating a space between two contacts.

AL/CU – A marking designation used on certain devices to indicate their suitability for connection to either aluminum or copper conductors. Also referred to as CO/ALR.

Analog Signal – A signal that uses continuous physical variables such as voltage amplitude or frequency variations to transmit information. Contrast with Digital Signal.

Angle Plug – A plug that allows the attached flexible cord to exit at a right angle to the plug face.

ANSI (American National Standards Institute) – An organization that identifies industrial and public requirements for national consensus standards and coordinates and manages their development, resolves national standards problems, and ensures effective participation in international standardization.

ANSI/ASHRAE/IESNA Standard 90.1 – An energy standard for buildings except low-rise residential buildings, adopted by the Department of Energy as the commercial building reference standard for state building energy codes under the federal Energy Policy Act.

Asynchronous Transfer Mode (ATM) – A high-speed switching transmission protocol that uses payload packages organized into 53-byte cells to carry data.

Attenuation – The decrease in power received from power transmitted due to loss through transmission lines; measured in decibels.

Attenuation-to-Crosstalk Ratio (ACR) – The difference between attenuation and crosstalk measured in decibels (dB) at a given frequency. This difference is critical to ensure that the signal sent down the twisted-pair cable is stronger at the receiving end of the cable than any interference signals (crosstalk) from other cable pairs.

Attenuator – Electrical or optical element that reduces (attenuates) the intensity of the signal passing through it.

Automatic Grounding – A component that provides automatic grounding of an electrical wiring device when installed in a grounded metal enclosure. Eliminates the need for a bonding jumper.

AWG (American Wire Gauge) – Standard American measuring scheme for classifying wires according to the diameter of the conductors.

Auto ON/OFF – A control strategy used with occupancy sensors of turning lights on and off automatically; OFF when a space is unoccupied and ON whenever occupancy is detected.

Back Wire Terminal – A termination that can be accomplished by inserting a pre-stripped solid or stranded conductor into a wiring device terminal opening, followed by tightening the adjacent terminal screw.

Backbone Cabling – The physical interconnections between the entrance facility, equipment room, and various floors or telecommunications rooms.

Ballast – A device used with an electric-discharge lamp to obtain the necessary circuit conditions (voltage, current, and waveform) for starting and operating.

Bandwidth – A measure of the amount of information which can pass through a channel, expressed in Hertz (Hz). Higher bandwidth means greater capacity to carry data.

Bar Coil – A bar coil is constructed of a ferrite bar and is wrapped with copper wire. This device is used to reduce RFI generated by a dimmer or other electronic switching devices.

Bend Radius – The minimum radius to which a cable or fiber can be bent before excessive signal attenuation occurs.

BICSI (Building Industry Consulting Service International) – An industry association dedicated to the design and installation of communication wiring.

Bi-level Switching – A control strategy that focuses on switching individual lamps within a luminaire, or groups of luminaires to achieve a reduced, balanced lighting level.

Binding Post – Type of connecting device used in audio speaker circuits. A knurled nut is tightened over a speaker wire conductor inserted through a hole in a threaded post. Binding posts may also offer a female jack connection for use of banana-type jacks.

Bit Error Rate (BER) – The ratio of incorrectly transmitted bits to total transmitted bits. A primary specification for all transmission systems, it is usually expressed as a power of 10. The number of errors made in a digital transmission as compared to complete accuracy.

Box Mounted Dimmers/Fan Speed Control – Any dimmer or fan speed control that mounts in or on a NEMA standard switch box.

Bulb Sing (Filament Hum) – The audible noise which can come from an incandescent lamp controlled by a dimmer.

Bundle – More than one cable held in a single Grip.

Byte – A data unit made up of eight bits, sometimes referred to as an octet. Megabytes and gigabytes are commonly used measures of storage or memory capacity.

Cable – One or more electrical and/or optical conductors within a protective sheath.

Cable Assembly – A cable that has connectors installed on one or both ends. See Jumper and Pigtail.

Cable Modem – A modem used to link cable-supplied data to a computer network; for example, when a CATV provider offers high-speed, cable-based Internet service.

California Title 24 – In an effort to reduce electrical power consumption, California has enacted requirements for residential lighting. These requirements are that all permanently installed fixtures must be either high efficacy, controlled by a manual-on/automatic-off vacancy sensor or controlled by a dimmer. Visit www.energy.ca.gov/title24 for additional information.



Campus – A complex of buildings which operates as one continuous facility – e.g., multibuilding corporate headquarters, university, military base.

Candelabra – A small screw-base threaded lampholder accepting a bulb approximately 1/2" in diameter commonly used in night lights, indicator lights and Christmas tree bulbs.

Candlepower – A measurement of light at the source, not the object you light up.

GLOSSARY OF TERMS

Cascade Cable – A specialized cable used to link compatible computer network hardware (usually hubs) together to form a compound device that acts as a single, larger device. In the P&S Home Network Center, a cascade cable can link two hub modules to increase the number of ports available.

Category 3 – 100 ohm twisted-pair copper cable that meets or exceeds specifications in ANSI/TIA/EIA-568-B.2, Commercial Building Telecommunications Cabling Standard, and ISO/IEC 11801, Generic Cabling for Customer Premises, for transmissions up to 16 MHz.

Category 5 – 100 ohm twisted-pair copper cable that meets or exceeds specifications in ANSI/TIA/EIA-568-B.2 Annex N, Commercial Building Telecommunications Cabling Standard. Category 5 is no longer recognized for new commercial installation.

Category 5e – An enhanced form of Category 5, supporting high-speed data transmission per TIA/EIA-568-B.1.

Category 6 – 100 ohm twisted-pair copper cable that meets or exceeds specifications in ANSI/TIA/EIA-568-B.2-1, Commercial Building Telecommunications Cabling Standard, and ISO/IEC 11801, Generic Cabling for Customer Premises, for transmissions up to 250 MHz. Positive power sum attenuation-to-crosstalk ratio is characterized to 200 MHz.

Capacitor – An electronic device capable of storing an electrical charge. Used in circuits for a variety of functions often to reduce or eliminate noise.

CATV – Community Antenna Television, known as cable television.

CE Marking – A product marking required in Europe that indicates conformity to the “common level of safety” and is used to insure “free movement of goods” within the 19 countries of the European Union.

CEC – Canadian Electrical Code.

Centralized Cabling – An optical fiber cabling configuration, based on TIA/EIA-568-B.1, Optical Fiber Cabling Guidelines, from the work area to a centralized cross-connect using pull-through cables, an interconnect, or splice in the telecommunications room.

CFL – Compact fluorescent lamp. CFLs are a type of fluorescent lamp that provide similar light levels compared with incandescent lamps but offer longer lifecycles and consume less electricity.

Channel – The complete communications path between telecommunications room equipment and workstation equipment, which includes cross-connects and patch cords.

Choke – A device used to filter RFI noise generated by dimmers or other electronic switching devices.

Circuit Breaking Capability – Capability of a plug/receptacle combination to break live circuits up to their maximum load rating. Except in emergency situations, plugs and receptacles should not be engaged or disengaged while power is on.

Circuit Breaking Rating – A rating which indicates the ability of a connector to make and/or break a circuit under load. Such ratings are determined through testing by qualified laboratories.

Cladding – In fiber cable, the transparent outer concentric glass layer that surrounds the optical fiber core and has a lower index of refraction than the core. It provides total internal reflection and protects against scattering from contaminants at the core surface.

Clamping Voltage – The peak voltage that can be measured after a surge protective device has limited or “clamped” a transient voltage surge. Clamping voltage must be determined by using IEEE Standard C62 testing and evaluated by UL Standard 1449.

Clock Hanger – A single receptacle generally recessed behind a special cover plate having a hook or other means of supporting a wall-hung clock.

CO/ALR – A marking designation used on certain devices to indicate their suitability for connection to either aluminum or copper conductors.

Coaxial Cable – An electrical-transmission cable with a center conductor, insulating spacer, and an outer electrical shield. Provides high quality signal transmission for video and data applications.

Combination Wall Plates – A multiple gang wall plate with different openings in each gang for different devices.

Communications Plenum Cable (CMP) – Cable listed as suitable for use in ducts, plenums, and other spaces used for environmental air. It has adequate fire-resistant and low smoke-producing characteristics. Cables must pass required test for fire and smoke characteristics of wires and cables, NFPA 262 or UL 910.

Communications Riser Cable (CMR) – Cable listed as suitable for use in a vertical run in a shaft or from floor to floor. It has fire-resistant characteristics capable of preventing the carrying of fire from floor to floor. Cables must pass requirements of the Standard Test for Flame Propagation Height of Electrical and Optical-Fiber Cable Installed Vertically in Shafts, ANSI/UL 1666.

Configuration – A description of the arrangement, size, and number of contacts in an insert assembly. Typical configuration descriptions include the number of wires and poles and the presence of a separate grounding contact. The combination of such factors determine the connector’s electrical rating.

Connecting Block – A plastic block with metal wiring clips used to establish an electrical connection.

Connector – A mechanical device used to provide a means for aligning, attaching, and achieving continuity between conductors or optical fibers.

Connector Grip – A strain-relief grip for specific customer requirements. Usually attached to a connector retaining nut.

Connector, Small Form Factor – An optical fiber duplex connector with a footprint approximating that of an 8-position outlet connector typically used with 4-pair copper connectors.

Consolidation Point (CP) – A location for interconnection between horizontal cables extending from building pathways and horizontal cables extending into furniture pathways.

Cord Connector – A portable receptacle, which is provided, with means for attachment to a flexible cord and which is not intended for permanent mounting.

Core – The central, light-carrying part of an optical fiber through which light pulses are transmitted.

Corrosion-Resistant – A device constructed of special materials and/or suitably plated to withstand corrosive environments.

Cross-Connect – System component where jumper wires and patch cords are used to rearrange communications circuits in order to administer the network. Usually located in a telecommunications room or equipment room.

Crosstalk – Undesired signal in one circuit transferred from another circuit by induction.

CSA (Canadian Standards Association) – An organization serving a function for Canadian electrical manufacturers similar to that provided in the U.S. by Underwriters Laboratories, Inc. (UL). CSA develops safety and performance standards for electrical products that parallel, but are not always identical to, UL standards. CSA tests products and grants paying clients “certification” that their products meet CSA standards.

GLOSSARY OF TERMS

C-UL  – UL certification to CSA requirements, C-UL is a marking approved by the Standards Council of Canada. C-UL can be used on products to be installed in accordance with the Canadian Electrical Code.

Current – The flow of electrons through an electrical conductor, measured in amperes.

Daisy Chain – A cabling method (topology) of connecting devices in series. Daisy chaining is no longer recommended.

DALI – Digital Addressable Lighting Interface. A communication protocol developed primarily for fluorescent dimming systems. Part of an IEC standard.

Daylighting Control – A lighting control method that changes the amount of light provided by lighting fixtures as the contribution of ambient daylight changes.

dB (Decibel) – The standard unit of measure of signal gain or loss, used in attenuation and crosstalk measurements.

DBS (Direct Broadcast Satellite) – Satellite television service that is purchased through a subscription (DirecTV, DISH Network).

D.C. (Direct Current) – An electric current, for example, battery power, that flows only in one direction through a circuit.

Dedicated Circuit – A circuit established to provide control voltage and current to one load or one type of load, such as an electric range or a computer.

Deep Wall Plate – A wall plate that provides greater clearance for device mounting straps than standard wall plates.

Demarcation Point – The interface which marks the division between telephone company facilities and private building wiring, where ownership and operational control changes.

De-Rating – When two or more dimmers are ganged and heat sinking material is removed, it is important to “de-rate” or lower the wattage rating of the dimmer. This is due to the heat rise caused by the devices.

Digital Signal (DS) – A signal with a fixed number of discrete values. Commonly, a binary signal with two values that are used to transmit the two states (0,1) used by digital computers. Most data transmission in optical fibers is by digital optical pulses. Contrast with Analog Signal.

Dimmer – A switch with electronic components that permits variable control of lighting intensity.

Dimmer Derating – The reduced maximum load for a dimmer in a specific application. When dimmers are used in a multigang application they run hotter and therefore must be derated depending upon the number of dimmers being used and their locations within the box.

Dimming Ballast – A special ballast used with fluorescent dimmers to control the light intensity of fluorescent lamps.

DIN Rail – Metal component found in enclosures used for mounting control devices or power packs.

Direct-Buried Cable – A telecommunications cable designed to be installed under the surface of the earth, in direct contact with the soil.

Disconnect Use Only – Description of a connector not designed for engaging or disengaging under load. Such connectors are commonly used as cost-effective hard wiring alternatives.

“Disconnect Use Only” Rating – A rating of the current-carrying capability of individually engaged pin and sleeve contacts. Such ratings are established through testing for compliance with applicable standards or codes, as well as wire conductor size and insulation as defined in the National Electrical Code® (NEC®).

Dispersion – The spreading of light pulses as they travel through an optical fiber.

Door Switch – A momentary contact switch normally installed in a door-jamb. The switch is activated when the door is opened or closed.

Double Pole Switch (double-pole single-throw) – A switch that makes or breaks the connection of conductors of a single branch circuit.

Double Weave – Mesh braid with rows of two strands each.

DSL (Digital Subscriber Line) – A new digital connection method that provides high-speed Internet or other network connections over standard telephone wire.

Dual Cable Systems – CATV systems in which the incoming service is provided over two different cables, sometimes called A/B cable systems. For example, a system in which one cable (cable A) carries channels 2-50 and the other cable (cable B) carries channels 51-100. This is an older method of providing service, used when the initially installed cable lacks capacity to meet current needs.

Dual Relay – Control device containing two relays that enables simultaneous but independent control of two different loads.

Dual Technology – The combination of passive infrared and ultrasonic technologies used to detect occupancy.

Duplex Receptacle – Two receptacles in a common housing or mounting means which accepts two plugs.

Dustproof – A receptacle so constructed or protected that dust will not interfere with its operation.

DVD (Digital Video Disc) – An acronym commonly used to describe a device that plays DVD-format discs. Such devices (both dedicated DVD players and computer DVD drives) can supply video or other signals through a video or computer network.

DV/DT (Delta Voltage/Delta Time) – DV/DT is the rate of change in voltage over a certain time frame.

Electronic Dimming Ballast – A variable output electronic fluorescent ballast.

Electronic Industries Alliance (EIA) – Industry trade association which works with the Telecommunications Industry Association (TIA) in developing standards.

EMI – Electromagnetic interference or unwanted signal pick-up. One of two types of electrical “noise” caused by varying magnetic fields conducted into branch wiring from inductive load switching.

Energy – A measure of electrical power rated in joules.

Entrance Facility (EF) (telecommunications) – An entrance to a building for both public and private network service cables (including antennae) encompassing the entrance point at the building wall and continuing to the entrance room or space.

Equipment Room (ER) – A centralized space for telecommunications equipment serving one or multiple buildings. It contains more complex equipment than the telecommunications room, which serves each floor of a building.

Ethernet – The most commonly used protocol (language) in computer networking. Originally supported (and still commonly used) in 10 Mbps form (10Base-T), 100 Mbps Ethernet (Fast Ethernet or 100Base-T) is also available.

External Video – A video signal provided by an external source, such as cable, satellite, or antenna-received broadcast.

Fan Hum – Noise created by a fan motor when controlled by a standard speed control.

Far-End Crosstalk (FEXT) – Crosstalk measured at the cable end opposite from where the signal originates.

FCC – Federal Communications Commission.

GLOSSARY OF TERMS

F Connector – The 75 ohm radio frequency connector used with coaxial cable to attach drop cables to taps and other devices. The F connector does not have center pins. The F connector uses the solid copper center conductor of the coaxial cable itself as the center pin to establish the connection.

FDDI (Fiber Distributed Data Interface) – An ANSI standard for 100 Mbps fiber physical and data protocols, generally used in “backbone” applications.

Fed Spec – Devices which comply with Federal Specifications such as W-C-596 for connecting and W-S-896 for switches. Fed Spec Standards for switches and connecting devices include NEMA Performance Standards.

Feed Through – The practice of wiring a single branch circuit through a device and feeding power to other devices wired downstream. (Feeding through a GFCI would provide protection to downstream receptacles.)

Fiber (Optical Fiber) – A thin filament of glass or plastic capable of carrying information in the form of light.

Fiber Optics – Communications scheme which converts electrical energy to light in order to transmit through optical fiber.

Field Adjustable Trim Potentiometer – A small, typically screwdriver-adjustable, variable resistor. Used to adjust minimum level of light or speed of a fan.

Firestop – A material or device installed in a cable pathway to prevent the passage of flames, smoke, and gases.

Flanged Inlet – A plug which is intended for flush mounting on an appliance or equipment and which serves to connect utilization equipment to a cord connector.

Flanged Outlet – A receptacle which is intended for flush mounting on an appliance or equipment which is intended to establish electrical connection with an inserted plug.

Fluorescent Lamp – A glass housing that contains phosphorus in a sealed vacuum. When the phosphorus is excited from a voltage charge, it becomes ionized and gives off light.

Fluorescent Starter – A device rated in watts having a voltage-sensitive switch and a capacitor whose function is to provide a high-voltage pulse to start a fluorescent lamp.

Flush Wall Plate – A wall plate designed to mount flush with the wall surface or the plane surface of electrical equipment.

Foot-Candle – The amount of light one candle generates one foot away.

Four-Way Switch – A switch which is used in conjunction with two three-way switches to control one light or other connected equipment from three or more locations.

Floor Receptacle – A receptacle with a protective cover plate intended for mounting flush with the surface of the floor.

Frequency – The number of cycles completed by a signal in one second, expressed in Hertz.

Fresnel Lens – A lens recognized by its concentric rings that is used for passive infrared sensors.

Fusible Mechanical Interlock – A switchable IEC pin and sleeve receptacle that is mechanically interlocked to ensure that a plug cannot be engaged or disengaged under load. Fusible mechanical interlocks include a fusible disconnect switch inside a single, non-metallic enclosure. They are typically used to provide overload protection for portable equipment at the source of power access.

Fusion Splice – A permanent joint accomplished by applying localized heat sufficient to fuse or melt the ends of two optical fibers together, forming a continuous single fiber.

Gang – The space required for one wiring device, wall plate, etc.

GFCI (Ground Fault Circuit Interrupter) – A personnel protection device that detects current leakage and removes power to the receptacle.

Gigabit Ethernet – A carrier-sense multiple access with collision detection LAN standard developed by the IEEE 802 group operating at one Gb/s.

GigaHertz – A unit of frequency equal to one billion Hertz.

Grip – A flexible wire mesh cable holding device.

Ground Conductor – A conductor (identified as the bare or green conductor, normally non-current carrying) which is intentionally connected to earth ground to provide an intentional path for fault current to ground.

Grounding – A system in a connector assembly to ensure ground continuity. Ground conductors connect normally nonenergized metal components to earth and are not part of the electrical circuit.

GSA (General Services Administration, Federal Supply Service) – The U.S. Government administration responsible for the approval of Federal Specifications used in the purchase of products by all Federal agencies.

Headroom – The overhead or margin, expressed in decibels, by which a communications system exceeds minimum requirements.

Heat Sink – A metal plate used for absorbing or removing heat from the switching device (triac) in a dimmer or fan speed control.

Heat Sink Dimmer/Fan Speed Control – Any dimmer or fan speed control that mounts onto a NEMA standard switch box, but whose strap protrudes beyond the box and onto the surface of the wall itself. Heat sink dimmers and fan controls will not accept a traditional wall plate and usually are supplied with their own unique cover.

Hertz – A unit of frequency, one cycle.

Home Network Center – In the P&S Home Network Wiring System, the center point for all network cabling. The Home Network Center is configured for varying network needs, with modules.

Home Run – Also known as star topology, a cabling system where individual cables are run directly from the telecommunications room to each work area outlet.

Home Theater – Home entertainment system using television video and multi-channel audio to more closely approximate a movie theater experience. Typical home theater systems incorporate traditional front right and left audio channels, a front center channel, and a two-speaker rear channel.

Horsepower Rated – A device having a marked horsepower rating is intended for control of motor loads.

Horizontal Cabling – The portion of the wiring system extending from the workstation to the horizontal cross-connect in the telecommunications room.

Horizontal Cross-Connect – The cross-connection between horizontal and other cabling, such as backbone cabling.

Horizontal Length – The cable distance from the workstation to the telecommunications room cross-connect, a maximum of 295 ft. (100 meters).

Hospital Grade – A device constructed to meet performance requirements of high abuse areas found in hospital locations, tested to “Hospital Grade” requirements of Underwriters Laboratories Standard UL 498.

Hub – Equipment which serves as a centralized connection point for a network or a portion of network. Hubs contain multiplexing, switching, and bridging functions and are not considered part of the cabling infrastructure.

GLOSSARY OF TERMS

IEC (International Electrotechnical Commission) – The IEC is a worldwide standards organization having 43 countries as its members. The United States is active in many areas of the IEC and the standards it develops.

IECC – The International Energy Conservation Code, developed by the International Code Council® (ICC®), that provides the minimum energy efficiency provisions for residential and commercial buildings. It is written so that state and local jurisdictions can easily adopt the model as their energy code.

IEEE – Institute of Electrical and Electronic Engineers.

Illuminated – A device that, when connected to an electrical circuit, is lighted in the area of the face or handle.

Illumination – What results from light use. Point a flashlight on an object and you light it up or “illuminate” it.

Impedance – The resistance or opposition to the flow of alternating current within a circuit.

Impedance Matching – Matching impedances of adjoining circuit elements so that power transfer across the interface is maximized, in order to improve performance or to accomplish a specific effect.

Incandescent Lamp – A light bulb which contains a filament in a sealed vacuum. When voltage is applied to the filament, it heats, producing light.

Inductive Load – Electrical devices made of coiled or wound wire that create a magnetic field when energized. Components such as motors, solenoids and coils are all inductive loads.

Infrared (I.R.) – The invisible light emitted by all people, animals, and objects. Infrared is measured in terms of micrometers on the wavelength spectrum.

Inlet (Male Base) – A plug which is intended for flush or surface mounting on an appliance or equipment and which serves to connect utilization equipment to a connector.

Inrush Current – The maximum current drawn by a device during the starting period.

Insertion Loss – 1. The loss resulting from the insertion of a device in a transmission line. 2. In an optical fiber system, the loss of optical power caused by inserting a component, such as a connector, coupler, or splice into a previously continuous optical path.

Insulation Displacement Connection (IDC) – An electrical connection made by “punching down” a wire in a terminal, which cuts through the insulation to make contact with the conductor.

Interbuilding (Campus) Backbone – A backbone network providing communications among multiple buildings.

Interbuilding Backbone Cable – 1. Cable that runs between buildings in a campus environment. 2. Outside plant cabling.

Interchangeable – A device or combination of devices, each individually housed and having common mounting dimensions and intended for field installation on a single or multiple opening mounting strap. Also known as Despard®.

Interconnection – A connection scheme that provides for the connection of a cable to another cable or to an equipment cable.

Intermediate Cross-Connect (IC) – The cross-connection between the first and second level of backbone cabling.

Internal Video – A video signal provided by such in-home sources as a DVD player, VCR, camcorder, or video camera.

Intrabuilding Backbone Cable – Cable that runs between telecommunications rooms inside a building. Can be vertical or horizontal in physical configuration.

ISDN (Integrated Services Digital Network) – An integrated digital network in which the same time division switches and digital transmission paths are used to establish connections for different services, for example, telephony, data, telex, and fax.

Isolated Ground – A grounding type device in which the equipment ground contact and terminal are electrically isolated from the receptacle mounting means.

Jack – A device into which a plug is inserted in order to make electrical contact in a communication circuit.

Joule Rating – The measurement of a surge protective device’s ability to absorb heat energy created by transient surges. Note that the Joule rating is not a part of IEEE or UL Standards. It is not as significant a specification as clamping voltage, maximum surge current and other parameters recognized by these agencies.

Jumper – 1. An assembly of twisted pairs without connectors, used to join telecommunications circuits/links at the cross-connect. 2. An optical fiber cable with connectors installed on both ends. See Cable Assembly.

Jumper Wire – A short length of twisted pair cable used to route a circuit between two cross-connect termination points.

Key – A lampholder with a means of switching the lamp on or off as part of the device.

Keyless – A lampholder with no means of switching the light on or off at the lampholder.

Lace – Strand of wire usually the same material as the mesh used to weave closed a split mesh.

Lampholder – A device that establishes mechanical and electrical connection to an inserted lamp.

LAN (Local Area Network) – A network of computers and peripheral devices with a limited area such as a department, single building, or campus environment.

Launch Cable – Length of optical fiber cable used to condition the launch of the optical time domain reflectometer test signal so that the correct results will be obtained.

LED – Light Emitting Diode.

LEED® – Leadership in Energy and Environmental Design, a voluntary program administered by the U.S. Green Building Council. Projects achieve Certified, Silver, Gold, or Platinum ratings by satisfying standard prerequisites and going beyond this threshold to earn points in specific categories.

Lighted Handle – A switch with an integral lamp in the actuator that lights when the switch is in the “OFF” position.

Light Source – Used in conjunction with a power meter, the test equipment unit that normally contains a light-emitting diode or laser used to create a light wavelength for testing optical fiber cable loss or continuity.

Link – The basic, permanently installed, horizontal cabling path between the work area outlet and telecommunications room cross-connect. Often referred to as the contractor link.

Load Shedding – A lighting control strategy for selectively reducing the output of lighting fixtures or lamps on a temporary basis as a means to reduce peak demand charges.

Locking (Turnlok®) – A device designated to lock in place when it is rotated in a clockwise direction. The device can then only be removed when turned in a counterclockwise direction.

Locking Switch – A switch with a separate actuator key, rather than a toggle, to prevent unauthorized use.

Loss – Attenuation of the optical signal, usually measured in dB.

Loss Budget – The total allowable loss between source and detector allocated among fiber, connectors, splices, and safety margin.

Low-Voltage – A device designed for use under 50 volts.

GLOSSARY OF TERMS

Lumen – One foot-candle falling on one square foot of area.

Lux – Luminance measured in metric units vs. English units. Lux is the measurement of actual light available at a given distance. Lux = one lumen incident per square meter of illuminated surface area.

Main Cross-Connect (MC) – A cross-connect used with first level backbone, entrance, or equipment cables.

Maintained Contact Switch – When the actuator is moved to the “ON” position, this switch makes and retains the circuit contact until the actuator is manually moved to the “OFF” position.

MAN (Metropolitan Area Network) – A data communications network that covers an area larger than a campus area and smaller than that of a wide area network. It usually interconnects two or more LANs and covers an entire metropolitan area, such as a large city and its suburbs.

Manual Controller – A horsepower rated switch without overload protection. Used for the operation of small A.C. or D.C. motors.

Maximum (Peak) Surge Current – The peak surge current a surge protective device can withstand, based on IEEE Standard C62.45 test waveforms.

Mbps (MegaBits Per Second) – One million bits per second.

Mechanical Interlock – A switchable IEC pin and sleeve receptacle that is mechanically interlocked to ensure that a plug cannot be engaged or disengaged under load. They are typically used to provide a disconnect point in power circuits supplying portable equipment.

Mechanical Splicing – For optical fibers, permanently joining two fibers together by mechanical means to enable a continuous signal.

Media (telecommunications) – Wire, cable, or conductors used for telecommunications.

Medium Base (Edison) – The most common type of screw-in lampholder found in everyday lighting fixtures, table lamps and accepting incandescent bulbs with screw bases approximately 1" in diameter.

Megahertz (MHz) – A unit of frequency equal to one million cycles per second (Hertz).

Mesh – The tubular open braid portion of a wire mesh grip.

Mesh Termination – The method of securing woven strands at the ends of a wire mesh grip.

Microprocessor – Single chip computer element containing the control unit, central processing circuitry; arithmetic and logic function.

Midget – A device with a body diameter smaller than those of devices of a similar rating.

MLD (Multi-Location Dimming) – This is achieved through the use of specific components designed to interface and allow dimming control from any location, master or remote. In a true MLD situation, the master unit performs all dimming and switching functions. The remote units provide input to the master (i.e.; dim, bright, on or off, as desired).

Mode – 1. Loosely, a possible light path followed by light rays, as in multimode or single-mode. 2. Strictly, a distribution of electromagnetic energy that satisfies Maxwell's equations and boundary conditions in guided wave propagation, such as through a waveguide or optical fiber.

Modular Jack – A female telecommunications connector, which is mounted in a fixed location. Jacks are specified in IEC 603-7 and FCC Part 68 Subpart F. Also see Outlet.

Modular Plug – A male telecommunications connector, specified in IEC 603-7 and FCC Part 68 Subpart F.

Modulation – A process whereby certain characteristics of a wave, often called the carrier, are varied or selected in accordance with a modulating function. This includes amplitude, frequency or phase, and other modulation techniques.

Mogul – The largest screw-in type of lampholder accepting incandescent lamp bulbs having screw bases approximately 1-1/2" in diameter. Used in street lighting fixtures and industrial high bay fixtures.

Molded On – A connector that is factory molded to a length of flexible cord.

Momentary Contact – A switch which establishes circuit contact when its actuator is moved to, and held in, the “ON” position. The circuit is broken when the actuator is allowed to return, of itself, to the “OFF” position (such a switch may also be furnished to operate in the opposite mode).

M.O.V. – Metal Oxide Varistor, primary component of TVSS.

MTP™ – Factory-terminated multiple-termination fiber optic connector for 12-strand ribbon-fiber optic cable. Most commonly used in backbone (riser) applications such as the P&S PFOB System. MTP is a trademark of US Conec Ltd.

Multimedia – Applications which communicate information using more than one cabling means.

Multimode Optical Fiber – An optical fiber cable that allows light to travel in many bound modes; used in LAN applications. Multimode fibers have a larger core than single-mode (core/cladding 62.5/125 micrometers).

Multiple Weave – Wire mesh grips woven utilizing single, double, and triple strands of each wire material.

Multiplexing – Combining a number of individual messages over a common path – usually by frequency division or time division.

Multi-User Telecommunications Outlet Assembly (MUTOA) – A device grouping several telecommunications outlets into one location.

Narrow Wall Plate – A cover plate designed for flush mounting on narrow partitions having a width dimension of two inches or less.

Near-End Crosstalk (NEXT) – Electrical noise coupled from one pair of wires to another, measured from where the signal is transmitted.

NEC (National Electrical Code®) – A code providing for practical safeguarding of persons and property from hazards arising from the use of electricity.

NEC Amperage Rating – The most widely recognized rating for industrial applications. A current-carrying capability of a pin and sleeve system in accordance with Underwriters Laboratories Standards and wire conductor size and insulation per the National Electrical Code. Determined by qualified laboratory testing.

NEMA (National Electrical Manufacturers' Association) – An organization of electrical manufacturers that establishes standards for manufacturing and testing of performance and reliability of electrical products. NEMA tests are often the basis or prerequisite for approval by the Federal Government and/or by Underwriters' Laboratories, Inc.

NEMA Type 1 Enclosures – Intended for indoor use primarily to provide a degree of protection against limited amounts of falling dirt in locations where unusual service conditions do not exist.

NEMA Type 3 Enclosures – Intended for outdoor use primarily to provide a degree of protection against rain, sleet, and windblown dust; and to be undamaged by the formation of ice on the enclosure. They are not intended to provide protection against conditions such as internal condensation or internal icing.

GLOSSARY OF TERMS

NEMA Type 3R Enclosures – Intended for outdoor use primarily to provide a degree of protection against rain and sleet; and to be undamaged by the formation of ice on the enclosure. They are not intended to provide protection against conditions such as internal condensation, or internal icing.

NEMA Type 4 Enclosures – Enclosures intended for indoor or outdoor use primarily to provide a degree of protection against windblown dust and rain, splashing water, hose-directed water, and external ice formation.

NEMA Type 4X Enclosures – Enclosures intended for indoor or outdoor use primarily to provide a degree of protection against corrosion, windblown dust and rain, splashing water, hose-directed water, and external ice formation.

NEMA Type 7 Enclosures – Intended for indoor use in locations classified as Class 1, Group A, B, C, or D, as defined in the National Electrical Code. They shall be capable of withstanding the pressures resulting from an internal explosion of specified gases, and contain such an explosion sufficient that an explosive gas-air mixture existing in the atmosphere surrounding the enclosure will not be ignited. Enclosed heat generating devices shall not cause external surfaces to reach temperatures capable of igniting explosive gas-air mixtures in the surrounding atmosphere. Enclosures shall meet explosion, hydrostatic, and temperature design tests.

NEMA Type 9 Enclosures – Intended for indoor use in locations classified as Class II, Groups E, F, or G, as defined in the National Electrical Code. They shall be capable of preventing the entrance of dust. Enclosed heat generating devices shall not cause external surfaces to reach temperatures capable of igniting or discoloring dust on the enclosure or igniting dust-air mixtures in the surrounding atmosphere. Enclosures shall meet dust penetration and temperature design tests, and aging of gaskets (if used).

NEMA Type 12 Enclosures – Intended for indoor use primarily to provide a degree of protection against circulating dust, falling dirt, and dripping non-corrosive liquids. They are not intended to provide protection against such conditions as internal condensation.

NEMA Type 13 Enclosures – Intended for indoor use primarily to provide a degree of protection against lint, dust, spraying of water, oil, and non-corrosive coolant. They are not intended to provide protection against conditions such as internal condensation.

Network – An interconnection of computers, peripherals, and data/voice communications facilities.

NFPA (National Fire Protection Association) – An organization devoted to promoting the science and improving the methods of Fire Protection. Membership is open to anyone interested. Every three years the NFPA produces a new edition of the NEC (see above). The NFPA also provides many other useful publications dealing with fire prevention.

N.P.S. – National Pipe Straight Thread.

N.P.T. – National Pipe Tapered Thread.

Occupancy Sensor – A device that switches lights on and off or dims and brightens lights based on the presence or absence of people.

OFNP (Optical Fiber Non-conductive Plenum) – NFPA designation for optical fiber cable that contains no electrically conductive components and meets fire rating requirements for plenum (backbone) applications.

Ohm – The unit of measurement for electrical resistance.

Ohm's Law – States that, in a given electrical circuit, the amount at current in amps is equal to the pressure in volts divided by the resistance in ohms. The formula is:

I (Current) = V voltage or $V = I \times R$

R resistance or $R = V/I$

Open System Architecture – International standards for data networking which allow multi-vendor/multi-product applications.

Optical Fiber – A thin filament of glass or plastic capable of carrying information in the form of light.

Optical Power Meter – Test equipment that measures in dBm the strength of a light wave over a fiber cable.

Optical Time Domain Reflectometer (OTDR) – An instrument that measures transmission characteristics of fiber by measuring the backscatter and reflection of injected light as a function of time. Used to measure attenuation of fiber, splices, connectors, and locate faults.

OSHA (Occupational Safety and Health Administration) – That part of the U.S. Department of Labor responsible for assuring that employers provide safe and healthful working conditions and equipment for employees, and that employees properly avail themselves of these conditions. Note: OSHA does not approve products. Compliance with OSHA regulations is contingent on approval or listing of the product by an authorized testing laboratory, such as UL, and proper installation and/or use of the product in accordance with OSHA guidelines.

Oversized Wall Plate – A wall plate with length and width dimensions greater than standard wall plates.

Outlet – A point on the wiring system at which current is taken to supply utilization equipment.

Outlet (DataCom) – A fixed connection where horizontal cable terminates and work area equipment can be connected.

Outside Plant (OSP) – Telecommunications infrastructure designed for installation exterior to buildings.

Pair – Two wires, twisted together with a reciprocal color code.

Pair Twist – The uniform twist of an insulated copper pair that helps to improve the effects of capacitance imbalance and electromagnetic induction.

Passive Infrared-(P.I.R.) – Typically this term is used in reference to detecting infrared. A P.I.R. detector functions as a receiver of infrared emitted from a transmitter, such as the human body.

Patch Cord – A length of cable, with connectors on the ends, used to join telecommunications links at a cross-connect.

Patch Panel – Connecting hardware that can be accessed with patch cords to form cross-connection (usually located in a telecommunications room) used to modify, reconfigure, or administer communications networks.

PBX (Private Branch Exchange) – A telephone switching system serving one organization or business, which is connected to the public telephone system.

Peripherals – Devices used to extend the capability of a computer or network. These can include printers, scanners, external drives, modems, and more.

Permanent Link – The transmission path between any two interfaces of cabling, excluding patch cords, equipment, and work area cables.

Phase Control – The electronic process of chopping or turning on and off the AC line every half line cycle. It is commonly used in dimming and fan speed control applications.

Pigtail – A short length of copper or optical fiber cable that has a pre-installed connector on one end. See Cable Assembly and Jumper.

GLOSSARY OF TERMS

Pin and Sleeve – Industrial wiring devices utilizing round pin-shaped blades and tubular designed sleeve contacts.

Pilot Light – A switch with an integral lamp in the actuator which lights when the switch is in the “ON” position.

Plenum – A chamber which forms part of a building’s air distribution system.

Plug – A device utilizing blades which, when inserted into a receptacle, establishes connection between the conductors of the attached flexible cord and the conductors connected to the receptacle.

Polarization (plugs and receptacles) – A means of assuring the mating of plugs and receptacles of the same rating in only the correct position.

Polarity – The alignment of a plug and receptacle to ensure correct connection.

Pole – The term “pole” as used in designating plugs and receptacles refers to a terminal to which a circuit conductor (always current carrying) is connected. In switches, the number of poles indicates the number of conductors being controlled.

Port – Hardware entity at the end of each link.

Potentiometer (POT) – A variable resistor, when used in a phase control it adjusts the light intensity.

Power Budget – In fiber optics, the difference between the strength of the signal transmitter and the sensitivity of the signal receiver. It represents the maximum acceptable loss for the combination of components and connectors used on a link.

Power Connector – A plug or receptacle that provides connection for distribution of secondary electrical power from a power source to electrical equipment, either portable or stationary.

Powersum – A test method for four-pair cable which compares the sum of the pair-to-pair crosstalk from three pairs to the fourth pair.

Premises Wiring – The technology of wiring buildings and equipment for data, telephone, video and other electrical/electronic functions.

Preset – The ability of a dimmer or fan speed control to “remember” a desired level of output.

Pressure Termination – An electrical connection in which a stripped cable is secured in a wire well by a set screw. The simplest method of termination.

Propagation Delay – Time between when a signal is transmitted and when it is received at the opposite end of the cable.

Protocol – A set of rules governing the transmission of information over a data channel.

PDN (Public Data Network) – A network established and operated for the specific purpose of providing data transmission services to the public.

Pulling Grip – A reusable wire mesh grip for pulling cable, rope, or bare conductor.

Pulling Tension – The amount of pull (foot-pounds of tension) placed on a cable during installation.

Pull Switch – A switch with an actuator mechanism operated by a downward or outward pull.

Punchdown – Securing a conductor to a wiring terminal by placing the insulated conductor in the terminal groove and pushing down with a “punchdown” (impact) tool – creating an insulation displacement connection (IDC).

Push/Push – A means of achieving the preset features on a rotary dimmer or fan speed control. The secondary switching mechanism is activated by pushing the knob at any preset of light or speed.

RCDD (Registered Communications Distribution Designer) – Professional certification granted by BICSI (Building Industry Consulting Services International).

Recessed F Connector – A type of video connector in which the termination is recessed for a smoother appearance and greater termination protection.

Receptacle – A contact device which is intended to establish electrical connection with an inserted plug.

Refractive Index – The ratio of the velocity of light in a vacuum to the velocity of light in a given material.

Relay Rack – A vertical metal frame that is equipped with threaded holes at a predefined spacing in accordance with EIA-310-D, on the front of the rack (or on both the front and rear sides of the rack). It is used to mount termination hardware, electronic equipment, or a combination of both. It can be floor mounted (free standing) or wall mounted.

Resistive Load – A device which opposes the flow of electric current. There is a voltage drop across a resistive load, which causes the device to dissipate heat.

Response Time – The interval time required for a device to perform its stated function in reaction to specific condition(s), such as a transient voltage surge or ground fault.

Return Loss – 1. Noise or interference caused by impedance of a cable, expressed in decibels. 2. The amount of reflected power compared to the amount of incident power at an interface, expressed in dB. Return loss is a critical factor in single-mode links because reflected light can destabilize some lasers.

RF Control – Radio Frequency Control. Systems that use RF communication to propagate control messages between devices and/or throughout the system.

RFI (Radio Frequency Interference) – Electrical noise.

Ring – One of the two conductors or cable pair in a telephone circuit.

Riser – The path between floors of a building.

RJ (Registered Jack) – Telephone and data jack applications registered with FCC.

RJ31X – A specialized jack used to allow security systems to take immediate control of a phone line, even when it is already in use. The security module used in the P&S Home Network Wiring Center includes an RJ31X jack for this purpose.

R.M.S. (Root Means Square) – Used as an A.C. value of voltage or current. Expressed, for example, as 120 volts AC RMS.

Rocker Switch – A switch that is operated by a paddle-type actuator, such as a decorator switch.

RoHS – Restriction of Hazardous Substances Directive. This directive restricts the use of six hazardous materials in the manufacture of various types of electronic and electrical equipment. It has been adopted by the European Union and in modified form by some jurisdictions in the U.S.

Rotary Dimming – Is achieved through the rotation of a knob of any style to control the lighting level components.

Rough-In – Stage of network installation during which boxes are mounted and cabling is run.

Safety Switch – Common term for an enclosed switch, commonly used in service or motor-circuit disconnect applications or as a motor controller. It is typically used to provide a disconnect point in power circuits supplying stationary or permanently installed equipment. Safety switches may be either fusible or non-fusible.

Scattering – A property of a fiber that causes light to deflect from the fiber, contributing to losses.

Sectional Wall Plate – Individual section wall plates with different openings that can be field assembled into a custom multi-gang wall plate.

GLOSSARY OF TERMS

Self Modulating – A video device, for example, a VCR or video camera, which supplies video signals to a specified CATV or UHF channel. No separate modulator is required.

Series Circuit – A circuit in which the components are arranged end to end to form a single path for current.

Service Loop – The slack which should be left in the cable at the communications outlet to accommodate future needs.

Shield – Metallic layer placed around a conductor or group of conductors to prevent electrostatic or electromagnetic coupling between the enclosed wires and external fields.

Side Wire Terminal – A termination that can be accomplished by a 3/4" turn looping pre-stripped solid or stranded conductor under terminal screws.

Signal-to-Noise Ratio (SNR) – The ratio between the detected signal power and noise in a receiver, expressed in dB. The prime determining factor in bit error rate.

Single-Mode Fiber – An optical fiber that will allow only one mode to propagate. This fiber is typically a step index fiber.

Single Receptacle – A receptacle which accepts only one plug.

Single Pole Switch – (single-pole single-throw) – A switch that makes or breaks the connection of one conductor and controls one load from one location.

Single Weave – A wire mesh grip woven with single strands of wire material.

Slant Symbol (/) – As used in wiring device ratings, indicates that two or more voltage potentials can be used.

Slide Switch – A switch having a sliding actuating member which makes or breaks the switch contact mechanism.

Slide Dimming – Is achieved through the linear movement up and down or horizontal of a slide mechanism to control the lighting level.

Splice Tray – A container used to organize and protect fiber splices, as well as a means for storing fiber slack.

Split Circuit – A duplex receptacle that can be wired for two separate circuits.

Split Mesh – A wire mesh grip separated at one row along the wire mesh axis utilizing an additional lace or rods to weave closed around cable.

Star Wiring – Called Star Topology and Home Run, a method of cabling each telecommunications outlet directly to the horizontal cross-connect in the telecommunications room with an individual pair of cables.

Straight Blade – A plug, connector, receptacle, flanged inlet or flanged outlet providing no locking features.

Straight Tip (ST) – A type of optical fiber connector identified by its bayonet housing. The ferrule may be metallic, ceramic, or plastic.

Strain Relief Grip – A wire mesh grip used to relieve strain or stress at the transition point between relatively flexible cable or conduit and the rigid connection point.

Stranded – A number of solid wires twisted together to form a flexible conductor.

Strap Dimmer/Fan Speed Control – Any dimmer or fan speed control that will fit into a traditional NEMA standard switch box, without an external heat sink.

Subscriber Connector (SC) – A type of optical fiber identified by the square cross-section of its plastic housing.

Support Grip – A wire mesh grip used for permanent or temporary support of a length of cable.

Surface-Mounted – A device intended to be installed on the surface of a wall, panel, or equipment.

Surge-Suppression – The use of a device containing electronic components which limits peak voltage to a predetermined value when voltage spikes or surges appear on the connected line.

Switch – A device for making, breaking, or changing the connections in an electric current. An enclosed switch is located in a box or cabinet, may be fusible or non-fusible, and is commonly used in a service or motor-circuit disconnect capacity, as a disconnect when equipment is to be serviced, or as a motor controller.

"T" Rated Switch – A switch for tungsten filament lamps for both AC and DC current.

Tamper-Resistant – A receptacle which by its construction limits improper access to its energized contacts.

Tandem – A wall plate in which individual gangs are arranged vertically one above the other.

Telecommunications Room (TR) – An enclosed space for housing telecommunications equipment, cable terminations, and cross-connects. The room is the recognized cross-connect between the backbone cable and horizontal cabling.

Terminal – A terminal is a fixed location on a wiring device where a conductor is intended to be connected.

Three Position Center "OFF" – A two-circuit, three-position switch of either the maintained or momentary type, in which the "OFF" position is indicated by the centered position of the actuator.

Three-Way Switch (single-pole double-throw) – A switch which is used in pairs to control one load from two or more locations.

TIA (Telecommunications Industry Association) – Industry trade association which works with the Electronics Industry Association (EIA) in developing standards.

Tight-Buffered Cable – Type of cable construction in which each glass fiber is tightly buffered by a protective thermoplastic coating to a diameter of 900 microns. Increased buffering provides ease of handling and installing connectors.

Time Delay – A period of time when a load is energized or de-energized. At the end of the desired time period, the load changes state (i.e.; on or off).

Time Switch – An electronic or electromechanical control, used to schedule "turn on" and "turn off" time based on the time of day.

Timer – An electronic or electromechanical control, used to produce a time delay to control a load.

Tip – The positive conductor of a pair in a basic telephone circuit. The tip is grounded.

Toggle Switch – A switch having a lever-type actuating member which makes or breaks the switch contacts when its position is changed.

Toggle Dimming – Is achieved through up or down toggling of traditional switch style toggle used to control the dimming components.

Topology – The physical or geometric configuration of a local area network.

Toroid Choke – An electronic component constructed of a ferrite ring wrapped with copper wire, used to reduce RFI generated by an electronic switching device.

Touch Dimming – The ability of a dimmer to control lighting levels by sensing the touch of a hand to its sensor plate.

Transient Voltage Surge Suppressor (TVSS) – A device designed to protect sensitive electronic equipment from the harmful effects of transient voltage surges having entered the power line to which it is connected.

GLOSSARY OF TERMS

Transmitter (TX) – 1. An optoelectronic circuit that converts an electrical logic signal to an optical signal. 2. In fiber optics, using a source such as light-emitting diode or laser.

TRIAC (Bidirectional Triode Thyristor) – A solid-state output device capable of switching alternating current.

Trim Kit – For P&S Home Network Centers, a set of components enabling complete installation of capability-providing modules and cabling following cabinet rough-in, as well as providing a finished appearance.

Turnkey – An installation in which the user receives a complete, operational system, ready to be used.

Twisted Pair – Two insulated copper wires twisted together to reduce interference from each other.

UL (Underwriters Laboratories, Inc.) – “An independent not-for-profit organization testing for public safety.”

UL Listed – Indicates an item that has been tested and approved to the standards established by UL for safety.

UL Recognized – Refers to products that have been tested and approved to be used as component parts of equipment or products that are to be UL listed.

Ultrasonic – Technology to detect occupancy using high frequency (ultrasonic) sound waves and measuring the changes in the returning waves. Can sense around partitions.

USOC (Uniform Service Order Code) – Bell system term to denote varying pin configurations on registered jacks (RJ's).

UTP (Unshielded Twisted Pair) – Twisted-pair copper cables without metallic braid shielding – capable of high-speed voice and data transmission. The most common cabling used in the U.S. in structured wiring.

Ultraviolet – The invisible rays of the spectrum of light which are at its violet end. Sometimes abbreviated U.V.

Vacancy Sensor – A device that operates as a standard ON/OFF switch that will automatically turn lights off if the space becomes vacant. Required for certain residential applications under California Title 24.

Varistor – Variable resistor.

Voltage – A difference of potential measured in volts. The electric pressure available to cause a flow of electrons.

Voltage Rating – Ratings that indicate the current-carrying capability of a connector up to a specified voltage. Voltage ratings are determined by the air gap between contacts and between contacts and the shell.

Wall Plate – A plate designed to enclose a device box, with or without a device installed in the box.

Watertight – A classification of a device and/or enclosure with design considerations for preventing water from entering under specific conditions.

Wavelength – The length of a wave measured from any point on one wave to the corresponding point on the next wave, such as from crest to crest. The wavelength of light is usually measured in nanometers (nm).

WD-1 – Standards Publications by NEMA. General requirements for wiring devices.

WD-5 – Has been merged with WD-1.

WD-6 – Standards Publications by NEMA. Wiring devices – dimensional requirements.

Weatherproof – A device constructed or protected such that exposure to weather will not interfere with successful operation (N.E.C.).

Wet Location; Cover Open – A cover, UL Listed, in accordance with specific test standards for use in wet and damp locations with the cover opened (plug cap inserted) or closed.

Wet Location; Only with Cover Closed – A cover, UL Listed, in accordance with specific test standards for use in damp locations with the cover closed, or wet locations only when the cover is closed.

Wide-Area Network (WAN) – Computer networks where devices are connected over extended distances using telecommunications links, such as telephone lines, satellites, and microwave connections, rather than a length of cable.

Wire Size – Conductors for building wiring are available in AWG (American Wire Gauge) sizes ranging from #14 to 4/0. The larger the number size, the smaller the diameter. For example: #10 is smaller than #8. The larger the diameter of a wire, the less the resistance.

Wire Mesh Grip (Flexcor) – Woven wire mesh holding devices used to support, pull, or relieve strain exerted upon cables, conduit, tubing, and various other items.

Wiring Closet – Termination point for customer premises wiring offering access to service personnel.

Work Area Outlet – A connecting device in the work area where horizontal cable terminates and work area equipment can be connected. Also called information outlet and telecommunications outlet.

Workstation – The location where telecommunications cabling is connected to work area equipment (PCs and peripherals) by means of a telecommunications outlet. Also called work area outlet and information outlet.

Note: Some definitions courtesy of BICSI.

INDEX

A — C

CAT. NO.	PAGE	CAT. NO.	PAGE	CAT. NO.	PAGE	CAT. NO.	PAGE
A							
ACD1	T-11	CD4FB	0-25	CG12511255	K-8	CG1830	K-9
ACD3	T-11	CD4FB3P	0-25	CG12512505	K-8	CG1834	K-9
AF152TR	D-2	CD4FBL	0-25	CG12513755	K-8	CG1836	K-9
AF202DFW	D-2	CD4FBL3P	0-25	CG125451000	K-8	CG1838	K-9
AF202TR	D-2	CD700	0-20	CG125451125	K-8	CG1840	K-9
AFGF152TR	D-3	CD703P	0-20	CG125451250	K-8	CG1842	K-9
AFGF202DFW	D-3	CD703PW	0-19	CG125451375	K-8	CG1844	K-9
AFGF202TR	D-3	CDADAPTORKIT	0-21	CG12545688	K-8	CG1846	K-9
AX30	M-9, M-18, M-20, M-24	CDDH16	0-26, 0-30	CG12545812	K-8	CG1848	K-9
AX60	M-9, M-18, M-20, M-24	CDFB10	0-22	CG12545875	K-8	CG1850	K-9
AXD60	M-18, M-20	CDFB10277	0-22	CG1256885	K-8	CG20013756	K-8
B							
BOX120	K-17	CDFB103P	0-23	CG1258125	K-8	CG20014376	K-8
BOX140	K-17	CDFB103P277	0-23	CG1258755	K-8	CG20015626	K-8
BOX22	K-17	CDFB16	0-22	CG125901000	K-8	CG20016886	K-8
BOX30	K-17	CDFB163P	0-23	CG125901125	K-8	CG20018126	K-8
BOX40	K-17	CDFB5	0-22	CG125901250	K-8	CG20018127	K-8
BOX52	K-17	CDFB53P	0-23	CG125901375	K-8	CG20019387	K-8
BOX70	K-17	CDFB7277	0-22	CG12590688	K-8	CG20020627	K-8
BOX94	K-17	CDFB73P277	0-23	CG12590812	K-8	CG20021887	K-8
BZ150	N-20	CDFB8	0-22	CG12590875	K-8	CG20023127	K-8
BZ200	N-20	CDFB83P	0-23	CG1422	K-9	CG20024387	K-8
BZ250	N-20	CDLV1100	0-21	CG142290	K-9	CG2009013756	K-8
BZ50	N-20	CDLV1103P	0-21	CG1424	K-9	CG2009015626	K-8
C							
C118HAC	P-12	CDLV1600	0-21	CG142490	K-9	CG2009016886	K-8
C118HGAC	P-12	CDLV1603P	0-21	CG1426	K-9	CG2009018126	K-8
C118RAC	P-12	CDLV700	0-21	CG142690	K-9	CG25018127	K-8
C118RGAC	P-12	CDLV703P	0-21	CG1428	K-9	CG25019387	K-8
C118WAC	P-12	CDSC12	0-26, 0-30	CG142890	K-9	CG25020627	K-8
C118WGAC	P-12	CDSC6	0-26, 0-30	CG1430	K-9	CG25021887	K-8
C5EF	T-17	CG10010004	K-7	CG143090	K-9	CG25023127	K-8
CA126GRY	R-8	CG10010005	K-7	CG1432	K-9	CG25024387	K-8
CA17G	R-8	CG10011255	K-7	CG143290	K-9	CG25188	K-7
CA18G	R-8	CG10012505	K-7	CG1434	K-9	CG25250	K-7
CA1G	R-7	CG10013755	K-7	CG1436	K-9	CG25312	K-7
CA1GL	R-7	CG100451000	K-7	CG1438	K-9	CG25375	K-7
CA1GS	R-7	CG10045562	K-7	CG1440	K-9	CG25438	K-7
CA1U2681G	R-6	CG10045625	K-7	CG1442	K-9	CG30018127	K-8
CA262G	R-8	CG10045688	K-7	CG15010005	K-8	CG30019387	K-8
CA268G	R-8	CG10045750	K-7	CG15011255	K-8	CG30020627	K-8
CA26GH	R-7	CG10045812	K-7	CG15012505	K-8	CG30021887	K-8
CA26GV	R-7	CG10045875	K-7	CG15013755	K-8	CG30023127	K-8
CA2G	R-8	CG10045938	K-7	CG15013756	K-8	CG30024387	K-8
CA2GS	R-8	CG1005624	K-7	CG15015626	K-8	CG30026259	K-8
CA2U2681G	R-6	CG1006254	K-7	CG15016886	K-8	CG30028129	K-8
CA721G	R-6	CG1006884	K-7	CG15018126	K-8	CG30030009	K-8
CA723G	R-6	CG1007504	K-7	CG150451000	K-8	CG30032509	K-8
CA726G	R-8	CG1008124	K-7	CG150451125	K-8	CG35031808	K-8
CA72G	R-8	CG1008754	K-7	CG150451250	K-8	CG35033358	K-8
CA78G	R-8	CG100901000	K-7	CG150451375	K-8	CG35035308	K-8
CA7GV	R-6	CG10090562	K-7	CG15045688	K-8	CG38188	K-7
CA82G	R-8	CG10090625	K-7	CG15045812	K-8	CG38250	K-7
CA8GH	R-6, R-15	CG10090688	K-7	CG15045875	K-8	CG38312	K-7
CA8GJ	R-6	CG10090750	K-7	CG1506885	K-8	CG38375	K-7
CA8GVFS	R-6	CG10090812	K-7	CG1508125	K-8	CG38438	K-7
CD1100	0-20	CG10090875	K-7	CG1508755	K-8	CG3890188	K-7
CD1103P	0-20	CG10090938	K-7	CG150901000	K-8	CG3890250	K-7
CD1600	0-20	CG1009384	K-7	CG150901125	K-8	CG3890312	K-7
CD1603P	0-20	CG1016	K-9	CG150901250	K-8	CG3890375	K-7
CD2000	0-20	CG101690	K-9	CG150901375	K-8	CG3890438	K-7
CD2003P	0-20	CG1018	K-9	CG150901562	K-8	CG40036909	K-8
CD250	N-7	CG101890	K-9	CG150901688	K-8	CG40038559	K-8
CD3FB10277	0-24	CG1020	K-9	CG150901812	K-8	CG40040259	K-8
CD3FB103P277	0-24	CG1022	K-9	CG15090688	K-8	CG406	K-9
CD3FB16	0-24	CG102245	K-9	CG15090812	K-8	CG40645	K-9
CD3FB163P	0-24	CG1218	K-9	CG15090875	K-8	CG40690	K-9
		CG1220	K-9	CG1630	K-9	CG408	K-9
		CG122090	K-9	CG1634	K-9	CG40890	K-9
		CG1222	K-9	CG1636	K-9	CG410	K-9
		CG122245	K-9	CG1638	K-9	CG41045	K-9
		CG122290	K-9	CG1640	K-9	CG41090	K-9
		CG12510005	K-8	CG1642	K-9	CG410F	K-9

INDEX

C

CAT. NO.	PAGE	CAT. NO.	PAGE	CAT. NO.	PAGE	CAT. NO.	PAGE
CG411	K-9	CG758124	K-7	CGN1251000	K-10	CGN7542UF	K-10
CG412	K-9	CG758754	K-7	CGN1251125	K-10	CGN75437	K-10
CG501881	K-7	CG7590500	K-7	CGN1251250	K-10	CGN75437BK	K-10
CG501882	K-7	CG7590562	K-7	CGN125750	K-10	CGN75437M	K-11
CG502501	K-7	CG7590625	K-7	CGN125875	K-10	CGN75437NM	K-12
CG502502	K-7	CG7590688	K-7	CGN125901000	K-10	CGN75500	K-10
CG503121	K-7	CG7590750	K-7	CGN125901125	K-10	CGN75500BK	K-10
CG503122	K-7	CG7590812	K-7	CGN125901250	K-10	CGN75500M	K-11
CG503751	K-7	CG759384	K-7	CGN12590750	K-10	CGN75500NM	K-12
CG503752	K-7	CG809	K-9	CGN12590875	K-10	CGN75562	K-10
CG504381	K-7	CG811	K-9	CGN25075	K-10	CGN75562BK	K-10
CG504382	K-7	CG812	K-9	CGN25135	K-10	CGN75562M	K-11
CG5045188	K-7	CG81245	K-9	CGN25200	K-10	CGN75562NM	K-12
CG5045312	K-7	CG81290	K-9	CGN38125	K-10	CGN75625	K-10
CG5045375	K-7	CG812F	K-9	CGN38187	K-10	CGN75625BK	K-10
CG5045438	K-7	CG814	K-9	CGN38250	K-10	CGN75625M	K-11
CG5045500	K-7	CG81445	K-9	CGN38312	K-10	CGN75625NM	K-12
CG5045562	K-7	CG81490	K-9	CGN38375	K-10	CGN7564UF	K-10
CG5045625	K-7	CG816	K-9	CGN50062	K-10	CGN75687	K-10
CG505002	K-7	CG81645	K-9	CGN50125	K-10	CGN75687M	K-11
CG505003	K-7	CG81690	K-9	CGN50187	K-10	CGN7590250	K-10
CG505622	K-7	CG816F	K-9	CGN50187M	K-11	CGN7590250M	K-11
CG505623	K-7	CGN1001000	K-10	CGN50187NM	K-12	CGN7590250NM	K-12
CG506252	K-7	CGN100437	K-10	CGN50250	K-10	CGN7590375	K-10
CG506253	K-7	CGN100437M	K-11	CGN50250M	K-11	CGN7590375M	K-11
CG506883	K-7	CGN100437NM	K-12	CGN50250NM	K-12	CGN7590375NM	K-12
CG507503	K-7	CGN100500	K-10	CGN50312	K-10	CGN759042UF	K-10
CG508123	K-7	CGN100500M	K-11	CGN50312BK	K-10	CGN7590437	K-10
CG5090188	K-7	CGN100500NM	K-12	CGN50312M	K-11	CGN7590437M	K-11
CG5090250	K-7	CGN100562	K-10	CGN50312NM	K-12	CGN7590437NM	K-12
CG5090312	K-7	CGN100562M	K-11	CGN50375	K-10	CGN7590500	K-10
CG5090375	K-7	CGN100562NM	K-12	CGN50375BK	K-10	CGN7590500M	K-11
CG5090438	K-7	CGN100625	K-10	CGN50375M	K-11	CGN7590500NM	K-12
CG5090500	K-7	CGN100625BK	K-10	CGN50375NM	K-12	CGN7590562	K-10
CG5090562	K-7	CGN100625M	K-11	CGN5042UF	K-10	CGN7590562M	K-11
CG5090625	K-7	CGN100625NM	K-12	CGN50437	K-10	CGN7590562NM	K-12
CG606	K-9	CGN100687	K-10	CGN50437BK	K-10	CGN7590625	K-10
CG608	K-9	CGN100687BK	K-10	CGN50437M	K-11	CGN7590625M	K-11
CG60845	K-9	CGN100687M	K-11	CGN50437NM	K-12	CGN7590625NM	K-12
CG60890	K-9	CGN100687NM	K-12	CGN50500	K-10	CGN759064UF	K-10
CG610	K-9	CGN100750	K-10	CGN50500BK	K-10	CGN7590687	K-10
CG61045	K-9	CGN100750BK	K-10	CGN50500M	K-11	CGN7590687M	K-11
CG61090	K-9	CGN100750M	K-11	CGN50562	K-10	CGSS1001000	K-14
CG612	K-9	CGN100750NM	K-12	CGN50562M	K-11	CGSS1001000M	K-15
CG61245	K-9	CGN100812	K-10	CGN5064UF	K-10	CGSS100562	K-14
CG61290	K-9	CGN100812BK	K-10	CGN5090187M	K-11	CGSS100562M	K-15
CG7510004	K-7	CGN100812M	K-11	CGN5090187NM	K-12	CGSS100625	K-14
CG751882	K-7	CGN100812NM	K-12	CGN5090250M	K-11	CGSS100625M	K-15
CG752502	K-7	CGN100875	K-10	CGN5090250NM	K-12	CGSS100687M	K-15
CG753122	K-7	CGN100875BK	K-10	CGN5090312M	K-11	CGSS100688	K-14
CG753752	K-7	CGN100875M	K-11	CGN5090312NM	K-12	CGSS100750	K-14
CG754382	K-7	CGN100875NM	K-12	CGN5090375M	K-11	CGSS100750M	K-15
CG7545500	K-7	CGN100901000	K-10	CGN5090375NM	K-12	CGSS100812	K-14
CG7545562	K-7	CGN10090437	K-10	CGN509042UF	K-10	CGSS100812M	K-15
CG7545625	K-7	CGN10090437NM	K-12	CGN5090437M	K-11	CGSS100875	K-14
CG7545688	K-7	CGN10090500	K-10	CGN5090437NM	K-12	CGSS100875M	K-15
CG7545750	K-7	CGN10090500NM	K-12	CGN5090500M	K-11	CGSS100937M	K-15
CG7545812	K-7	CGN10090562	K-10	CGN5090562M	K-11	CGSS100938	K-14
CG755002	K-7	CGN10090562M	K-11	CGN509064UF	K-10	CGSS1251000	K-14
CG755003	K-7	CGN10090625	K-10	CGN75187	K-10	CGSS1251000M	K-15
CG755622	K-7	CGN10090625M	K-11	CGN75187BK	K-10	CGSS1251125	K-14
CG755623	K-7	CGN10090625NM	K-12	CGN75187M	K-11	CGSS1251125M	K-15
CG755624	K-7	CGN10090687	K-10	CGN75187NM	K-12	CGSS1251250	K-14
CG756252	K-7	CGN10090687M	K-11	CGN75250	K-10	CGSS1251250M	K-15
CG756253	K-7	CGN10090687NM	K-12	CGN75250BK	K-10	CGSS1251375	K-14
CG756254	K-7	CGN10090750	K-10	CGN75250M	K-11	CGSS1251375M	K-15
CG756883	K-7	CGN10090750M	K-11	CGN75250NM	K-12	CGSS125688	K-14
CG756884	K-7	CGN10090750NM	K-12	CGN75375	K-10	CGSS125688M	K-15
CG757503	K-7	CGN10090812	K-10	CGN75375BK	K-10	CGSS125812	K-14
CG757504	K-7	CGN10090875	K-10	CGN75375M	K-11	CGSS125812M	K-15
CG758123	K-7	CGN10090875M	K-11, K-12	CGN75375NM	K-12	CGSS125875	K-14

INDEX

C — F

CAT. NO.	PAGE	CAT. NO.	PAGE	CAT. NO.	PAGE	CAT. NO.	PAGE
CGSS125875M	K-15	CGSS50438	K-14	CS15AC3	A-7	E	
CGSS1501000	K-14	CGSS50438M	K-15	CS20AC1	A-7	ECS1200	N-13
CGSS1501000M	K-15	CGSS50500	K-14	CS20AC3	A-7	EHR100I	N-14
CGSS1501125	K-14	CGSS50500M	K-15	CS500	N-3	EHR200I	N-14
CGSS1501125M	K-15	CGSS50562	K-14	CS6360	H-32	EHU15AN	E-33, G-4, G-5, G-6
CGSS1501250	K-14	CGSS50562M	K-15	CS6361	H-32	ERS100	N-14
CGSS1501250M	K-15	CGSS50625	K-14	CS6364	H-33	ERS200	N-14
CGSS1501375	K-14	CGSS50625M	K-15	CS6365	H-33	EWS100	N-13
CGSS1501375M	K-15	CGSS75500	K-14	CS6369	H-33	EWS101	N-13
CGSS150688	K-14	CGSS75500M	K-15	CS6370	H-32	EWS200	N-13
CGSS150688M	K-15	CGSS75562	K-14	CS6375	H-33	EWS201	N-13
CGSS150812	K-14	CGSS75562M	K-15	CS6377	H-32	EXT1	P-2
CGSS150812M	K-15	CGSS75625	K-14	CS8164	H-33	EXT2	P-2
CGSS150875	K-14	CGSS75625M	K-15	CS8165	H-33	F	
CGSS150875M	K-15	CGSS75687M	K-15	CS8169	H-33	FB1TRDRB	P-13
CGSS2001375	K-14	CGSS75688	K-14	CS8175	H-33	FB1TRDRN	P-13
CGSS2001375M	K-15	CGSS75750	K-14	CS8177	H-33	FB1TRSRB	P-13
CGSS2001562	K-14	CGSS75750M	K-15	CS8264	H-32	FB1TRSRN	P-13
CGSS2001562M	K-15	CGSS75812	K-14	CS8265	H-32	FB2TRDR2B	P-14
CGSS2001688	K-14	CGSS75812M	K-15	CS8269	H-32	FB2TRDR2N	P-14
CGSS2001688M	K-15	CH250	N-6	CS8275	H-32	FB2TRDRKS4B	P-14
CGSS2001812	K-14	CI205	N-16	CS8364	H-33	FB2TRDRKS4N	P-14
CGSS2001812M	K-15	CI2051	N-16	CS8365	H-33	FBOX1	R-10
CGSS2001938	K-14	CI355	N-16	CS8369	H-33	FC050LB	K-19
CGSS2001938M	K-15	CR15	B-25	CS8375	H-33	FC050OF	K-19
CGSS2002062	K-14	CR20	B-25	CS8464	H-32	FC050U	K-19
CGSS2002062M	K-15	CR5266X	G-5	CS8465	H-32	FC050UU	K-19
CGSS2002188	K-14	CR5269X	G-5	CS8469	H-32	FC062LB	K-19
CGSS2002188M	K-15	CR6200	B-10	CS8475	H-32	FC062OF	K-19
CGSS2002312	K-14	CR6300	B-10	CSB15AC1	A-7	FC062U	K-19
CGSS2002312M	K-15	CR6307	B-77	CSB15AC2	A-7	FC062UU	K-19
CGSS2002438	K-14	CR6360	H-36	CSB15AC3	A-7	FC075LB	K-19
CGSS2002438M	K-15	CR6361	H-32, H-36	CSB15AC4	A-7	FC075OF	K-19
CGSS2501812	K-14	CR6364	H-33, H-36	CSB20AC1	A-7	FC075U	K-19
CGSS2501812M	K-15	CR6365	H-33, H-36	CSB20AC2	A-7	FC075UU	K-19
CGSS2501938	K-14	CR6369	H-33, H-36	CSB20AC3	A-7	FC100LB	K-19
CGSS2501938M	K-15	CR6370	H-32, H-36	CSB20AC4	A-7	FC100OF	K-19
CGSS2502062	K-14	CR6375	H-33	CT1	P-7	FC100U	K-19
CGSS2502062M	K-15	CR7716N	H-32, H-33, H-34, H-36	CX105	N-15	FC100UU	K-19
CGSS2502188	K-14	CR7717N	H-32, H-33, H-34, H-36	CX1051	N-15	FC125LB	K-19
CGSS2502188M	K-15	CRB5262	B-24	D		FC125OF	K-19
CGSS2502312	K-14	CRB5262SI	B-24	D0531	B-78, G-12	FC125U	K-19
CGSS2502312M	K-15	CRB5362	B-24	D0533	B-78, G-12	FC125UU	K-19
CGSS3002635	K-14	CRB5362S	B-24	D0551	B-78, G-12	FC150LB	K-19
CGSS3002635M	K-15	CRL1420C	H-13	D0553	B-78, G-12	FC150OF	K-19
CGSS3002812	K-14	CRL1420P	H-13	D0631	B-78, G-12	FC150U	K-19
CGSS3002812M	K-15	CRL1430C	H-20	D0633	B-78, G-12	FC150UU	K-19
CGSS3003000	K-14	CRL1430P	H-20	D0651	B-78, G-12	FC175LB	K-19
CGSS3003000M	K-15	CRL2030RBC	H-9, H-21, H-27, H-34, H-36	D0653	B-78, G-12	FC175OF	K-19
CGSS3003250	K-14	CRL2030RBP	H-9, H-21, H-27, H-34, H-36	D0731	G-12	FC175U	K-19
CGSS3003250M	K-15	CRL515C	H-6	D0751	G-12	FC175UU	K-19
CGSS38188	K-14	CRL515P	H-6	D1861	B-78, G-12	FC200LB	K-19
CGSS38250	K-14	CRL520C	H-9	DC1	H-34	FC200OF	K-19
CGSS38250M	K-15	CRL520P	H-9	DR1103PV	O-12	FC200U	K-19
CGSS38312	K-14	CRL520R	H-9, H-11, H-12, H-16, H-17	DR703PV	O-12	FC200UU	K-19
CGSS38312M	K-15	CRL530C	H-16, H-36	DRCL453P	O-12	FC22	K-23
CGSS38375	K-14	CRL530P	H-16, H-36	DRDH163PV	O-12, O-27	FC22GL	E-33, G-4, G-5, H-21, H-35, K-17
CGSS38375M	K-15	CRL530R	H-16, H-36	DRLV703PV	O-12	FC250LB	K-19
CGSS38438	K-14	CRL620C	H-10	DRSC53PV	O-12, O-27	FC250OF	K-19
CGSS38438M	K-15	CRL620P	H-10	DSW100	N-10	FC250U	K-19
CGSS50188	K-14	CRL620R	H-10	DSW200	N-10	FC250UU	K-19
CGSS50250	K-14	CRL630C	H-17	DSW301	N-12	FC30	K-23
CGSS50250M	K-15	CRL630P	H-17	DSW302	N-12	FC300LB	K-19
CGSS50312	K-14	CS1200	N-3	DT300	N-18	FC300OF	K-19
CGSS50312M	K-15	CS15AC1	A-7	DT355	N-18	FC300U	K-19
CGSS50375	K-14						
CGSS50375M	K-15						

INDEX

F – L

CAT. NO.	PAGE	CAT. NO.	PAGE	CAT. NO.	PAGE	CAT. NO.	PAGE
FC30GL	E-33, G-4, G-5, H-21, H-35, K-17	FR175U	K-21	GASKET3780	R-22	IGL820R	H-11, F-15
FC30LB	K-23	FR175UU	K-21	GASKET38	R-22	J	
FC350LB	K-19	FR200LB	K-21	GH5	K-23	JP12845C5E	T-18
FC3500F	K-19	FR200U	K-21	H			
FC40	K-23	FR200UU	K-21	HB350WL	N-3	JP24845C5E	T-18
FC40GL	E-33, G-4, G-5, H-21, H-35, K-17	FS050LB	K-20	HB350WL3	N-19	JP36845C5E	T-18
FC40LB	K-23	FS0500F	K-20	HB350WL4	N-19	K	
FC52	K-23	FS050U	K-20	HBP112L7	N-19	K1	S-19
FC52GL	E-33, G-4, G-5, H-21, H-35, K-17	FS050UU	K-20	HCL453PMMTC	0-4	K2	S-19
FC52LB	K-23	FS062LB	K-20	HCL453PMMW	0-4	K3	S-19
FC70	K-23	FS0620F	K-20	HDH163PMMTC	0-27	K4	S-19
FC70GL	H-21, H-35, K-17	FS062UU	K-20	HDH163PMMW	0-27	KS226	T-16
FC70LB	K-23	FS0750F	K-20	HDHKIT	0-4, 0-27	KS326	T-16
FC94	K-23	FS075U	K-20	HMKIT	0-4	KS426	T-16
FC94GL	H-21, H-35, K-17	FS100LB	K-20	HMRKIT	0-4	KSBNC	T-16
FC94LB	K-23	FS1000F	K-20	HMRTC	0-4	KSRCAB	T-16
FCHL075U	K-22	FS100U	K-20	HMRW	0-4	KSRCAR	T-16
FCHL075UU	K-22	FS100UU	K-20	HP30EX	A-27, M-5	KSRCAY	T-16
FCHL100U	K-22	FS125LB	K-20	I			
FCHL100UU	K-22	FS1250F	K-20	IG26262	F-13, B-35	KSSC	T-16
FCHL125U	K-22	FS125U	K-20	IG26262HG	F-13, B-35, B-42, E-16, E-19	KSST	T-16
FCHL125UU	K-22	FS150LB	K-20	IG26362	F-13, B-35	KSSV	T-16
FCHL150U	K-22	FS1500F	K-20	IG26362HG	F-13, B-35, B-42, E-16, E-19	KTPD4	T-16
FCHL150UU	K-22	FS150U	K-20	IG420	B-75	KTPD6	T-16
FCHL200UU	K-22	FS150UU	K-20	IG420HISP	B-75, E-34	KTPDL1	T-16
FCHL250UU	K-22	FS175LB	K-20	IG4700	F-15	KTPDL4	T-16
FCHL300UU	K-22	FS1750F	K-20	IG4700	H-6	KTPDL6	T-16
FCHL350UU	K-22	FS175U	K-20	IG4710	F-15, H-6	L	
FCSD22	K-23	FS2	T-10	IG4760	F-15, H-7	L0115	H-5
FCSD30	K-23	FS200LB	K-20	IG5261	F-13, B-35	L1020C	H-12
FCSD30LB	K-23	FS2000F	K-20	IG5262	F-11, F-13, B-35	L1020FI	H-12
FCSD40	K-23	FS200U	K-20	IG5262ISP	F-6, B-72	L1020FO	H-12
FCSD52	K-23	FS200UU	K-20	IG5361	F-13, B-35	L1020P	H-12
FCSD52LB	K-23	FS25	T-10	IG5362	F-13, B-35, E-16	L1020R	H-12
FCSD70	K-23	FS250LB	K-20	IG5362SP	F-6, B-72	L1030C	H-19
FCSD70LB	K-23	FS2500F	K-20	IG5662	B-35, F-13	L1030FI	H-19
FCSD94	K-23	FS250U	K-20	IG5862	F-13, B-35, E-16	L1030FO	H-19
FCSD94LB	K-23	FS250UU	K-20	IG8200	F-13, B-13, B-35, E-10, E-16	L1030P	H-19
FD11	L-7	FS300LB	K-20	IG8200ISP	F-5, B-71, E-30	L1030R	H-19
FD12	L-7	FS3000F	K-20	IG8300	F-13, B-13, B-35, E-10, E-16	L1120C	H-12
FD13	L-7	FS300U	K-20	IG8300ISP	F-5, B-71, E-30	L1120FO	H-12
FD21	L-7	FS300UU	K-20	IG8301	F-13, B-35, E-16	L1120P	H-12
FD22	L-7	FS350LB	K-20	IG8800	F-13, B-13, B-35, E-10, E-16	L1120R	H-12
FD23	L-7	FS3500F	K-20	IGL1420R	F-15, H-13	L1130C	H-19
FDC21	L-7	FS350U	K-20	IGL1430R	F-15, H-20	L1130FI	H-19
FDC22	L-7	FS350UU	K-20	IGL1520R	F-15, H-13	L1130FO	H-19
FDC23	L-7	FS4	T-10	IGL1530R	F-15, H-20	L1130P	H-19
FO22	L-7	FS5	T-10	IGL1620R	F-15, H-13	L1130R	H-19
FR050LB	K-21	FSHL075U	K-22	IGL2120R	F-15, H-15	L1220C	H-12
FR050U	K-21	FSHL075UU	K-22	IGL2130R	F-15, H-23	L1220FI	H-12
FR050UU	K-21	FSHL100U	K-22	IGL2220R	F-15, H-15	L1220FO	H-12
FR062LB	K-21	FSHL100UU	K-22	IGL2230R	F-15, H-23	L1220P	H-12
FR062U	K-21	FSHL125U	K-22	IGL2320R	F-15, H-15	L1220R	H-12
FR062UU	K-21	FSHL125UU	K-22	IGL2330R	F-15, H-23	L1230C	H-19
FR075LB	K-21	FSHL150U	K-22	IGL520P	F-15, H-9	L1230FI	H-19
FR075U	K-21	FSHL150UU	K-22	IGL520R	F-15, H-9, H-11, H-12, H-16, H-17	L1230FO	H-19
FR075UU	K-21	FSHL200UU	K-22	IGL530R	F-15, H-16	L1230P	H-19
FR100LB	K-21	FSHL250UU	K-22	IGL620R	F-15, H-10	L1230R	H-19
FR100U	K-21	FSHL300UU	K-22	IGL630P	F-15	L1330C	H-19
FR100UU	K-21	FSHL350UU	K-22	IGL630R	F-15	L1330FI	H-19
FR125LB	K-21	FSHL400UU	K-22	IGL720R	F-15	L1330FO	H-19
FR125U	K-21	G				L1330P	H-19
FR125UU	K-21	GARD3GR	R-21	IGL720R	H-10	L1330R	H-19
FR150LB	K-21	GASKET1	S-36	L			
FR150U	K-21	GASKET2	R-22	IGL1420P	H-13	L1420C	H-13
FR150UU	K-21	GASKET3726	R-22	L1420CGCM	H-25	L1420FI	H-13
FR175LB	K-21			L1420FO	H-13	L1420P	H-13

INDEX

L – P

CAT. NO.	PAGE	CAT. NO.	PAGE	CAT. NO.	PAGE	CAT. NO.	PAGE
L1420PGCM	H-25	L2030RBC	H-9, H-12, H-21, H-27, H-34	L630FO	H-17	LTB15090SS	K-16
L1420R	H-13	L2030RBP	H-9, H-12, H-21, H-27, H-34	L630P	H-2, H-17	LTB20090SS	K-16
L1430C	H-20	L2120C	H-15	L630PGCM	H-25	LVDIV1	P-5
L1430CGCM	H-25	L2120FI	H-15	L630R	G-2, H-17	M	
L1430FI	H-20	L2120FO	H-15	L720C	H-10	M118W	P-4
L1430FIKIT	H-20	L2120P	H-15	L720FI	H-10	ML1113	H-4
L1430FO	H-20	L2120R	H-15	L720FO	H-10	ML1133	H-4
L1430KIT	R-16	L2130C	H-23	L720P	H-10	ML114	H-4
L1430KIT	R-16	L2130FI	H-23	L720PGCM	H-25	ML115	H-4
L1430P	H-20	L2130FO	H-23	L720R	H-10	ML2113	H-4
L1430PGCM	H-25	L2130P	H-23	L730C	H-17	ML2133	H-4
L1430R	H-20	L2130R	H-23	L730CGCM	H-25	ML214	H-4
L1520C	H-13	L2220C	H-15	L730FI	H-17	ML215	H-4
L1520CBK	H-13	L2220FI	H-15	L730FO	H-17	ML3113	H-4
L1520FI	H-13	L2220FO	H-15	L730P	H-17	ML3133	H-4
L1520FO	H-13	L2220P	H-15	L730PGCM	H-25	ML314	H-4
L1520P	H-13	L2220R	H-15	L730R	H-17	ML315	H-4
L1520PBK	H-13	L2230C	H-23	L820C	H-11	MSP025	K-28
L1520R	H-13	L2230FI	H-23	L820FI	H-11	MSP050	K-28
L1530C	H-20	L2230FO	H-23	L820FO	H-11	MSP075	K-28
L1530FI	H-20	L2230P	H-23	L820P	H-11	MSP100	K-28
L1530FIBK	H-20	L2230R	H-23	L820R	H-11	MSP125	K-28
L1530FO	H-20	L2320C	H-15	L830C	H-18	MSP150	K-28
L1530FOBK	H-20	L2320FI	H-15	L830FI	H-18	N	
L1530P	H-20	L2320FO	H-15	L830FO	H-18	NTL81TRICC6	B-54
L1530R	H-20	L2320P	H-15	L830P	H-18	NTL873AMBERWCC6	B-54
L15AN	H-8, H-35	L2320R	H-15	L830R	H-18	NTL885TRAMBERWCC6	B-54
L15RBC	G-5, H-21, H-27, H-34	L2330C	H-23	L920C	H-11	NTL885TRICC6	B-54
L15RBP	G-5, H-21, H-27, H-34	L2330FI	H-23	L920FI	H-11, H-17, H-18	NTLFULLAMBERWCC6	B-54
L1620C	H-13	L2330FO	H-23	L920FO	H-11, H-17, H-18	NTLFULLTCCC6	B-54
L1620FI	H-13	L2330P	H-23	L920P	H-11	NTLFULLWCC6	B-54
L1620FO	H-13	L2330R	H-23	L920R	H-11	P	
L1620P	H-13	L3720C	H-11	L930C	H-18	P0501	K-27
L1620R	H-13	L3720FI	H-11	L930FI	H-18	P0751	K-27
L1630C	H-21	L3720FO	H-11	L930FO	H-18	P0752	K-27
L1630FI	H-21	L3720PGCM	H-25	L930P	H-18	P1001	K-27
L1630FO	H-21	L3720P	H-11	LLRKV	0-10, 0-28	P1002	K-27
L1630P	H-21	L3720R	H-11	LRKV	0-10, 0-28	P100ND	P-5
L1630R	H-21	L520C	H-9, H-11, H-16, H-17, H-18	LS1000	0-8	P100WD	P-5
L1730C	H-21	L520CBK	H-9	LS1000P	0-8	P108N	P-4
L1730FI	H-21	L520CGCM	H-25	LS1003P	0-8	P108W	P-4
L1730FO	H-21	L520FI	H-9, H-10, H-11, H-16, H-17, H-18	LS600	0-8	P116W	P-4
L1730P	H-21	L520FO	H-9, H-10, H-11, H-16, H-17, H-18	LS600P	0-8	P118R	P-3
L1730R	H-21	L520P	H-9, H-11, H-16, H-17, H-18	LS603P	0-8	P118RN	P-3
L1820C	H-14, H-22	L520PBK	H-9, H-11	LSCL450	0-9	P122B	P-6
L1820FI	H-14, H-22	L520PGCM	H-25	LSCL453P	0-9	P122C	P-3
L1820FO	H-14, H-22	L520R	H-9, H-11, H-12, H-16, H-17, H-18	LSCLDC163P	0-9, 0-11, 0-28	P122N	P-3
L1820P	H-14, H-22	L530CGCM	H-25	LSDC163PV	0-11, 0-28	P122RN	P-3
L1820R	H-14, H-22	L530C	H-16	LSDC16V	0-11, 0-28	P122V	K-27
L1830C	H-22	L530FI	H-16	LSDD300	0-10	P1501	K-27
L1830FI	H-22	L530FO	H-16	LSDH16V	0-11, 0-28	P1502	K-27
L1830FO	H-22	L530R	H-16	LSDS300PV	0-10	P2001	K-27
L1830P	H-22	L530PGCM	H-25	LSDV25V	0-11, 0-28	P2002	K-27
L1830R	H-22	L620C	H-10	LSLV600	0-8	P235RAC	P-3
L1920C	H-14, H-22	L620CGCM	H-25	LSLV600P	0-8	P235RACMH	P-3
L1920FI	H-14, H-22	L620FI	H-10	LSLV603P	0-8	P242RRD	P-8
L1920FO	H-14, H-22	L620FO	H-10	LSSC5	0-11, 0-28	P242SRD	P-8
L1920P	H-14, H-22	L620P	H-10	LSSC5P	0-11, 0-28	P2501	K-27
L1920R	H-14, H-22	L620R	H-10	LTB38SS	K-16	P2502	K-27
L1930C	H-22	L620R	H-10	LTB50SS	K-16	P3001	K-27
L1930FI	H-22	L630C	H-2, H-17	LTB75SS	K-16	P3002	K-27
L1930FO	H-22	L630CGCM	H-25	LTB100SS	K-16	P3501	K-27
L1930P	H-22	L630FI	H-17	LTB125SS	K-16	P3502	K-27
L1930R	H-22	L630CGCM	H-25	LTB150SS	K-16	P354RACMH	P-3
L2020C	H-14, H-22	L630P	H-2, H-17	LTB200SS	K-16	PAR1	R-21
L2020FI	H-14, H-22	L630R	H-2, H-17	LTB3890SS	K-16	PCC6	T-18
L2020FO	H-14, H-22	L630R	H-2, H-17	LTB5090SS	K-16	PDV2B	P-5
L2020P	H-14, H-22	L630R	H-2, H-17	LTB7590SS	K-16		
L2020R	H-14, H-22	L630R	H-2, H-17	LTB10090SS	K-16		
L20303AN	H-8, H-35	L630R	H-2, H-17	LTB12590SS	K-16		
L203045AN	H-8, H-35	L630R	H-2, H-17				

INDEX

P

CAT. NO.	PAGE	CAT. NO.	PAGE	CAT. NO.	PAGE	CAT. NO.	PAGE
PH122B	P-6	PM3001	K-25	PS1502	K-26	PS3100C7WL	J-17
PH122R	P-3	PM3002	K-25	PS154S	C-24	PS3100C7WR	J-17
PJ100	K-24	PM3003	K-25	PS15AC1	A-5	PS3100MIR4W	J-12
PJ1KIT	K-24	PM3501	K-25	PS15AC1CPL	A-5	PS3100MIR6W	J-12, J-29
PJ25	K-24	PM3502	K-25	PS15AC1CSL	A-5	PS3100MIR7W	J-12, J-29
PJ37	K-24	PM3503	K-25	PS15AC1L	A-5	PS3100P4W	J-12, J-17, J-29
PJ50	K-24	PP21	S-44	PS15AC2	A-5	PS3100P4WR	J-17
PJ62	K-24	PP210	S-44	PS15AC3	A-5	PS3100P6W	J-12, J-17, J-29
PJ75	K-24	PP22	S-44	PS15AC3CPL	A-5	PS3100P7W	J-12, J-17, J-29
PJSC14L	S-25	PP23	S-44	PS15AC3CSL	A-5	PS3100P7WR	J-17
PJSC1L	S-25	PP24	S-44	PS15AC3L	A-5	PS3100R4W	J-17, J-29
PJSC26L	S-25	PP25	S-44	PS15AC4	A-5	PS3100R4WL	J-17
PJSC8L	S-25	PP26	S-44	PS15WT	L-7	PS3100R6W	J-17, J-29
PJSE14L	S-25	PP27	S-44	PS15WTAM	L-11	PS3100R6WL	J-17
PJSE1L	S-25	PP28	S-44	PS16CLF	I-10	PS3100R7W	J-17, J-29
PJSE26L	S-25	PP29	S-44	PS16CLM	I-10	PS3100R7WL	J-17
PJSE8L	S-25	PP31	S-44	PS163AM	L-12	PS320B6S	J-18, J-30
PL0501	K-24	PP310	S-44	PS2001	K-26	PS320C4S	J-18, J-30
PL0621	K-24	PP32	S-44	PS2002	K-26	PS320C4W	J-16, J-29
PL0622	K-24	PP33	S-44	PS204S	C-24	PS320C4WR	J-16
PL0751	K-24	PP34	S-44	PS20AC1	A-4, A-5	PS320C5W	J-16, J-29
PL0752	K-24	PP35	S-44	PS20AC1CPL	A-5	PS320C5WR	J-16
PL1001	K-24	PP36	S-44	PS20AC1CPL7	A-5	PS320C6S	J-18, J-30
PL1002	K-24	PP37	S-44	PS20AC1CSL	A-5	PS320C6W	J-16, J-29
PL1251	K-24	PP38	S-44	PS20AC1KL	A-5	PS320C6WR	J-16
PL1252	K-24	PP39	S-44	PS20AC1L	A-5	PS320C7W	J-16, J-29
PL1501	K-24	PP41	S-44	PS20AC2	A-5	PS320C7WR	J-16
PL1502	K-24	PP410	S-44	PS20AC2CPL	A-5	PS320MIR4W	J-12
PL1751	K-24	PP42	S-44	PS20AC2HP	A-27, M-5	PS320MIR6W	J-12
PL2001	K-24	PP43	S-44	PS20AC2KL	A-5	PS320MIR7W	J-12
PL2002	K-24	PP44	S-44	PS20AC2L	A-5	PS320P4S	J-18, J-30
PL204L	C-24	PP45	S-44	PS20AC3	A-5	PS320P4W	J-12, J-16, J-29
PL2501	K-24	PP46	S-44	PS20AC3CPL	A-5	PS320P4WR	J-16
PL2502	K-24	PP47	S-44	PS20AC3CSL	A-5	PS320P5S	J-18, J-30
PL3002	K-24	PP48	S-44	PS20AC3KL	A-5	PS320P5W	J-16, J-29
PLS1820F	I-11	PP49	S-44	PS20AC3L	A-5	PS320P5WR	J-16
PLS1820M	I-11	PP51	S-44	PS20AC3RPL7	A-5	PS320P6S	J-18, J-30
PLS182F	I-11	PP510	S-44	PS20AC4	A-5	PS320P6W	J-12, J-16, J-29
PLS182MBK	I-11	PP52	S-44	PS20AC4IL	A-5	PS320P6WR	J-16
PLS1840F	I-11	PP53	S-44	PS20AC4KL	A-5	PS320P7W	J-12, J-16, J-29
PLS1840M	I-11	PP54	S-44	PS20FB	I-5	PS320P7WR	J-16
PLV1B	P-5	PP55	S-44	PS20MBBK	I-5	PS320R4W	J-16, J-29
PLV1R	P-5	PP56	S-44	PS2501	K-26	PS320R4WL	J-16
PLV1S	P-5	PP57	S-44	PS2502	K-26	PS320R5S	J-18, J-30
PLV1W	P-5	PP58	S-44	PS27WT	L-7	PS320R5W	J-16, J-29
PLV2B	P-5	PP59	S-44	PS27WTAM	L-11	PS320R5WL	J-16
PLV2W	P-5	PS0501	K-26	PS3001	K-26	PS320R6S	J-18, J-30
PLV3W	P-5	PS0502	K-26	PS3002	K-26	PS320R6W	J-16, J-29
PM037	K-25	PS0622	K-26	PS30AC1	A-5	PS320R6WL	J-16
PM050	K-25	PS0751	K-26	PS30AC1RPL	A-5	PS320R7W	J-16, J-29
PM0501	K-25	PS0752	K-26	PS30AC2	A-5	PS320R7WL	J-16
PM075	K-25	PS1	F-16, F-17, B-82, B-83	PS30AC2HP	A-27, M-5	PS330B4S	J-18, J-30
PM0751	K-25	PS1001	K-26	PS30AC2RPL	A-5	PS330B6S	J-18, J-30
PM0752	K-25	PS1002	K-26	PS30AC3	A-5	PS330B7S	J-18, J-30
PM0753	K-25	PS100FSS	M-15	PS30AC3RPL	A-5	PS330C4S	J-18, J-30
PM100	K-25	PS100SS	M-9	PS30FSS	M-15	PS330C4W	J-16, J-29
PM1001	K-25	PS100SSAX	M-9	PS30RSAX	M-9	PS330C4WL	J-16
PM1002	K-25	PS100SSAX3	M-9	PS30SS	M-9	PS330C6S	J-18, J-30
PM1003	K-25	PS100SSAXRC	M-9	PS30SSAX	M-9, M-24	PS330C6W	J-16, J-29
PM125	K-25	PS100SSRC	M-9	PS30SSAX3	M-9, M-24	PS330C6WL	J-16
PM150	K-25	PS103AM	L-12	PS30SSAXRC	M-9	PS330C7S	J-18, J-30
PM1501	K-25	PS104AM	L-12	PS30SSRC	M-9, M-24	PS330C7W	J-16, J-29
PM1502	K-25	PS10PC	F-16, F-17, B-82, B-83	PS3100B6W	J-17, J-29	PS330C7WL	J-16
PM1503	K-25			PS3100B7W	J-17, J-29	PS330C7WR	J-16
PM1KIT	K-25	PS123AM	L-12	PS3100C4W	J-17, J-29	PS330FMIR6W	J-7, J-29
PM2001	K-25	PS124AM	L-12	PS3100C4WL	J-17	PS330MIR4W	J-12, J-29
PM2002	K-25	PS1251	K-26	PS3100C4WR	J-17	PS330MIR6W	J-12
PM2003	K-25	PS143AM	L-12	PS3100C6W	J-17, J-29	PS330MIR7W	J-12
PM2501	K-25	PS14WT	L-7	PS3100C6WL	J-17	PS330P4S	J-18, J-30
PM2502	K-25	PS14WTAM	L-11	PS3100C6WR	J-17	PS330P4W	J-12, J-16, J-29
PM2503	K-25	PS1501	K-26	PS3100C7W	J-17, J-29	PS330P6S	J-18, J-30

INDEX

P

CAT. NO.	PAGE	CAT. NO.	PAGE	CAT. NO.	PAGE	CAT. NO.	PAGE
PS330P6W	J-7, J-12, J-16, J-29	PS4100C12WL	J-17	PS430246	I-4	PS460C5S	J-18, J-30
PS330P7S	J-18, J-30	PS4100C12WR	J-17	PS430B12S	J-18, J-30	PS460C5W	J-17, J-29
PS330P7W	J-12, J-16, J-29	PS4100C5W	J-17, J-29	PS430B5S	J-18, J-30	PS460C7S	J-18, J-30
PS330P7WR	J-16	PS4100C5WL	J-17	PS430B7S	J-18, J-30	PS460C7W	J-17, J-29
PS330R4S	J-18, J-30	PS4100C5WR	J-17	PS430B9S	J-18, J-30	PS460C9S	J-18, J-30
PS330R4W	J-16, J-29	PS4100C7W	J-17, J-29	PS430C12S	J-18, J-30	PS460C9W	J-17, J-29
PS330R4WL	J-16	PS4100C7WL	J-17	PS430C12W	J-16, J-29	PS460C9WR	J-17
PS330R6S	J-18, J-30	PS4100C9W	J-17, J-29	PS430C12WL	J-16	PS460FMIR12W	J-7, J-29
PS330R6W	J-16, J-29	PS4100C9WL	J-17	PS430C12WR	J-16	PS460FMIR5W	J-7, J-29
PS330R7W	J-16, J-29	PS4100C9WR	J-17	PS430C3W	J-16, J-29	PS460FMIR7W	J-7, J-29
PS330R7WL	J-16	PS4100FMIR12W	J-7, J-29	PS430C3WR	J-16	PS460FMIR9W	J-7, J-29
PS3501	K-26	PS4100FMIR5W	J-7, J-29	PS430C5S	J-18, J-30	PS460MIR12W	J-12, J-29
PS3502	K-26	PS4100FMIR7W	J-7, J-29	PS430C5W	J-16, J-29	PS460MIR5W	J-12, J-29
PS360B4W	J-17, J-29	PS4100FMIR9W	J-7, J-29	PS430C5WL	J-16	PS460MIR7W	J-12, J-29
PS360B6S	J-18, J-30	PS4100MIR12W	J-12, J-29	PS430C7S	J-18, J-30	PS460MIR9W	J-12, J-29
PS360B6W	J-17, J-29	PS4100MIR5W	J-12, J-29	PS430C7W	J-16, J-29	PS460P12S	J-18, J-30
PS360B7S	J-18, J-30	PS4100MIR7W	J-12, J-29	PS430C7WR	J-16	PS460P12W	J-7, J-12, J-17, J-29
PS360C4W	J-17, J-29	PS4100MIR9W	J-12, J-29	PS430C9S	J-18, J-30	PS460P12WR	J-17
PS360C4WL	J-17	PS4100P12W	J-7, J-12, J-17, J-29	PS430C9W	J-16, J-29	PS460P5S	J-18, J-30
PS360C4WR	J-17	PS4100P5W	J-7, J-12, J-17, J-29	PS430C9WR	J-16	PS460P5W	J-7, J-12, J-17, J-29
PS360C6S	J-18, J-30	PS4100P7W	J-7, J-12, J-17, J-29	PS430CFMIR12W	J-7, J-29	PS460P7S	J-18, J-30
PS360C6W	J-17, J-29	PS4100P9W	J-7, J-12, J-17, J-29	PS430FMIR3W	J-7, J-29	PS460P7W	J-7, J-12, J-17, J-29
PS360C6WR	J-17	PS4100R12W	J-17, J-29	PS430FMIR5W	J-7, J-29	PS460P9S	J-18, J-30
PS360C7S	J-18, J-30	PS4100R5W	J-17, J-29	PS430FMIR7W	J-7, J-29	PS460P9W	J-7, J-12, J-17, J-29
PS360C7W	J-17, J-29	PS4100R5WL	J-17	PS430FMIR9W	J-7, J-29	PS460R12S	J-18, J-30
PS360C7WL	J-17	PS4100R7W	J-17, J-29	PS430MIR3W	J-12, J-29	PS460R12W	J-17, J-29
PS360C7WR	J-17	PS4100R7WL	J-17	PS430MIR5W	J-12, J-29	PS460R5S	J-18, J-30
PS360FMIR6W	J-7, J-29	PS4100R9W	J-17, J-29	PS430MIR7W	J-12, J-29	PS460R5W	J-17, J-29
PS360MIR4W	J-12	PS420B5S	J-18, J-30	PS430MIR9W	J-12, J-29	PS460R5WL	J-17
PS360MIR6W	J-12, J-29	PS420B7S	J-18, J-30	PS430P12W	J-7, J-16	PS460R7S	J-18, J-30
PS360MIR7W	J-12, J-29	PS420B9S	J-18, J-30	PS430P12WR	J-16	PS460R7W	J-17, J-29
PS360P4W	J-12, J-17, J-29	PS420C12S	J-18, J-30	PS430P3W	J-7, J-12, J-16, J-29	PS460R9S	J-18, J-30
PS360P6S	J-18, J-30	PS420C12W	J-16, J-29	PS430P3WR	J-16	PS460R9W	J-17, J-29
PS360P6W	J-7, J-12, J-17, J-29	PS420C12WR	J-16	PS430P5S	J-18, J-30	PS4720SSAN	H-8
PS360P6WR	J-17	PS420C5W	J-16, J-29	PS430P5W	J-7, J-12, J-16, J-29	PS5100B5W	J-17, J-29
PS360P7S	J-18, J-30	PS420C5WR	J-16	PS430P7S	J-18, J-30	PS5100B7W	J-17, J-29
PS360P7W	J-12, J-17, J-29	PS420C7S	J-18, J-30	PS430P7W	J-7, J-12, J-16, J-29	PS5100B9W	J-17, J-29
PS360P7WR	J-17	PS420C7W	J-16, J-29	PS430P7WR	J-16	PS5100C5W	J-17, J-29
PS360R4W	J-17, J-29	PS420C7WR	J-16	PS430P9S	J-18, J-30	PS5100C5WL	J-17
PS360R6S	J-18, J-30	PS420C9S	J-18, J-30	PS430P9W	J-7, J-12, J-16, J-29	PS5100C5WR	J-17
PS360R6W	J-17, J-29	PS420C9W	J-16, J-29	PS430P9WR	J-16	PS5100C7W	J-17, J-29
PS360R7S	J-18, J-30	PS420C9WR	J-16	PS430R12S	J-18, J-30	PS5100C7WL	J-17
PS360R7W	J-17, J-29	PS420FMIR12W	J-7, J-29	PS430R12W	J-16, J-29	PS5100C9W	J-17, J-29
PS360R7WL	J-17	PS420FMIR5W	J-7, J-29	PS430R3W	J-16, J-29	PS5100C9WL	J-17
PS371510	A-6	PS420FMIR7W	J-7, J-29	PS430R3WL	J-16	PS5100C9WR	J-17
PS371530	A-6	PS420FMIR9W	J-7, J-29	PS430R5S	J-18, J-30	PS5100FMIR5W	J-7, J-29
PS372010	A-6	PS420MIR12W	J-12, J-29	PS430R5W	J-16, J-29	PS5100FMIR7W	J-7, J-29
PS372010KL	A-6	PS420MIR5W	J-12, J-29	PS430R7S	J-18, J-30	PS5100FMIR9W	J-7, J-29
PS372010L	A-6	PS420MIR7W	J-12, J-29	PS430R7W	J-16, J-29	PS5100MIR5W	J-12, J-29
PS372030	A-6	PS420MIR9W	J-12, J-29	PS430R9S	J-18, J-30	PS5100MIR7W	J-12, J-29
PS372030L	A-6	PS420P12S	J-18, J-30	PS430R9W	J-16, J-29	PS5100MIR9W	J-12, J-29
PS3F	I-8	PS420P12W	J-7, J-12, J-16, J-29	PS430R9WL	J-16	PS5100P5W	J-7, J-12, J-17, J-29
PS3M	I-8	PS420P5W	J-7, J-12, J-16, J-29	PS4502	K-26	PS5100P5WR	J-17
PS4001	K-26	PS420P5WR	J-16	PS45FR2SBBK	I-7	PS5100P7W	J-7, J-12, J-17, J-29
PS4002	K-26	PS420P7S	J-18, J-30	PS45FRBBK	I-7	PS5100P7WR	J-17
PS40CLL3RBBK	I-9	PS420P7W	J-7, J-12, J-16, J-29	PS45FRSBBK	I-7	PS5100P9W	J-7, J-12, J-17, J-29
PS40FB	I-5	PS420P9S	J-18, J-30	PS45MR2SBBK	I-7	PS5100P9WR	J-17
PS40FCBK	I-8	PS420P9W	J-7, J-12, J-16, J-29	PS45MRBBK	I-7	PS5100R5W	J-17, J-29
PS40FRBBK	I-6	PS420P9WR	J-16	PS45MRSBBK	I-7	PS5100R5WL	J-17
PS40FRSBBK	I-6	PS420R12S	J-18, J-30	PS460B12S	J-18, J-30	PS5100R7W	J-17, J-29
PS40MB	I-5	PS420R12W	J-16, J-29	PS460B12WL	J-17, J-29	PS5100R7WL	J-17
PS40MC	I-8	PS420R12WL	J-16	PS460B5S	J-18, J-30	PS5100R9W	J-17, J-29
PS40MRBBK	I-6	PS420R5S	J-18, J-30	PS460B5W	J-17, J-29	PS515CCLB	G-13
PS40MRSBBK	I-6	PS420R5W	J-16, J-29	PS460B7S	J-18, J-30	PS515PCLB	G-13
PS40WTCSEBK	I-9	PS420R7S	J-18, J-30	PS460B7W	J-17, J-29	PS520710	I-10
PS40WTCLBK	I-9	PS420R7W	J-16, J-29	PS460B9S	J-18, J-30	PS520B5S	J-18, J-30
PS4100B12W	J-17, J-29	PS420R9S	J-18, J-30	PS460B9W	J-17, J-29	PS520B7S	J-18, J-30
PS4100B5W	J-17, J-29	PS420R9W	J-16, J-29	PS460C12S	J-18, J-30	PS520B9S	J-18, J-30
PS4100B7W	J-17, J-29	PS430171	I-4	PS460C12W	J-17, J-29	PS520C5S	J-18, J-30
PS4100B9W	J-17, J-29	PS430244	I-4, I-10	PS460C12WL	J-17	PS520C5W	J-16, J-29
PS4100C12W	J-17, J-29	PS430245	I-10	PS460C12WR	J-17	PS520C5WR	J-16

INDEX

P

CAT. NO.	PAGE	CAT. NO.	PAGE	CAT. NO.	PAGE	CAT. NO.	PAGE
PS520C7S	J-18, J-30	PS5366XGCM	G-7, G-13	PS60FSS	M-15	PSBBN601W	J-17, J-18,
PS520C7W	J-16, J-29	PS5366XGCMAN	G-13	PS60SS	M-9, M-24		J-25, J-29, J-30
PS520C7WR	J-16	PS5366XHG	E-33, G-4	PS60SS (AX)	M-15	PSCP100	J-26
PS520C9S	J-18, J-30	PS5369XHG	E-33, G-4	PS60SSAX	M-9, M-24	PSCP320	J-26
PS520C9W	J-16, J-29	PS5369XGCM	G-7	PS60SSAX3	M-9	PSCP3430	J-26
PS520CP9WR	J-16	PS5369XHG	E-33, G-4	PS60SSAXRC	M-9, M-24	PSCP420	J-26
PS520CCLB	G-13	PS5369Y	G-8	PS60SSRC	M-9, M-24	PSCP520	J-26
PS520PCLB	G-13	PS54664Y	G-8	PS665089V	T-18	PSCP530	J-26
PS520MIR9W	J-12	PS54666HGAN	E-33, G-4, G-6	PS7	F-16, F-17, B-82, B-83	PSCP60	J-26
PS520P5W	J-16, J-29	PS54666SSAN	G-6	PS7L	F-16, F-17, B-82, B-83	PSDS100	M-18, M-21
PS520P5WR	J-16	PS54666X	G-5	PS7P	F-16, F-17, B-82, B-83	PSDS100AX	M-18, M-21
PS520P7W	J-16, J-29	PS54666XGCM	G-7	PS811120I	A-18	PSDS100AXRC	M-18, M-21
PS520P7WR	J-16	PS54666XHG	E-33, G-4	PS81120I	A-18	PSDS100AXSR	M-21
PS520P9W	J-12, J-16, J-29	PS5469X	G-5	PS8115	E-33, G-4, G-8	PSDS100RC	M-18, M-21, M-24
PS520P9WR	J-16	PS5469XGCM	G-7	PS8119	E-33, G-4, G-8	PSDS100SR	M-21
PS520R5S	J-18, J-30	PS5469XHG	E-33, G-4	PS8200H	B-12, E-9	PSDS30	M-18
PS520R5W	J-16, J-29	PS5469Y	G-8	PS8200HS	B-12, E-9	PSDS30AX	M-18
PS520R7W	J-16, J-29	PS560B5S	J-18, J-30	PS8300H	B-12, E-9	PSDS30AX3	M-18
PS520R9S	J-18, J-30	PS560B5W	J-17, J-29	PS8300HS	B-12, E-9	PSDS30AX3SR	M-21
PS520R9W	J-16, J-29	PS560B7S	J-18, J-30	PS862TRC	P-15	PSDS30AXRC	M-18, M-21
PS5262	B-11	PS560B7W	J-17, J-29	PS862TRCAL	P-15	PSDS30AXSR	M-21
PS5266HGAN	E-33, G-4, G-6	PS560B9S	J-18, J-30	PS862TRGFC	P-15	PSDS30RC	M-18, M-21
PS5266SSAN	G-6	PS560B9W	J-17, J-29	PS862TRGFICAL	P-15	PSDS30SR	M-21
PS5266X	G-2, G-5	PS560C5S	J-18, J-30	PS862TRT	P-15	PSDS60	M-18
PS5266XGCM	G-7, G-13	PS560C5W	J-17, J-29	PS862TRTAL	P-15	PSDS60AX	M-18
PS5266XGCMAN	G-13	PS560C5WL	J-17	PS862TRTGFI	P-15	PSDS60AXRC	M-18, M-21
PS5266XHG	E-33, G-4	PS560C5WR	J-17	PS862TRTGFIAL	P-15	PSDS60AXSR	M-21
PS5269X	G-2, G-5	PS560C7S	J-18, J-30	PS863TRC	P-16	PSDS60HP	M-18
PS5269XGCM	G-7, G-13	PS560C7W	J-17, J-29	PS863TRCAL	P-16	PSDS60HPAX	M-18
PS5269XHG	E-33, G-4	PS560C7WL	J-17	PS863TRGFC	P-16	PSDS60HPAXRC	M-18, M-21
PS530B5S	J-18, J-30	PS560C7WR	J-17	PS863TRGFICAL	P-16	PSDS60HPAXSR	M-21
PS530B7S	J-18, J-30	PS560C9S	J-18, J-30	PS8C	F-16, F-17, B-82, B-83	PSDS60HPRC	M-18, M-21
PS530B9S	J-18, J-30	PS560C9W	J-17, J-29	PS8HWLW	B-48	PSDS60HPSR	M-21
PS530C5S	J-18, J-30	PS560FMI9S	J-7, J-29	PS8LM	A-18	PSDS60RC	M-18, M-21
PS530C5W	J-16, J-29	PS560FMIR5W	J-7, J-29	PS8P	F-16, F-17, B-82, B-83	PSDS60SR	M-21
PS530C5WL	J-16	PS560FMIR7W	J-7, J-29	PSAD100125	J-26	PSDFCBK	I-8
PS530C5WR	J-16	PS560FMIR9W	J-7, J-29	PSAD100150	J-26	PSGRIPKIT1	L-7
PS530C7W	J-16, J-29	PS560MIR5W	J-12, J-29	PSAD1002	J-26	PSGRIPKIT2	L-7
PS530C7WL	J-16	PS560MIR7W	J-12, J-29	PSAD2034	J-26	PSGRIPKIT3	L-7
PS530C7WR	J-16	PS560MIR9W	J-12, J-29	PSAD2050	J-26	PSHBP120277L4	N-3
PS530C9S	J-18, J-30	PS560P5S	J-18, J-30	PSAD301	J-26	PSIG5266X	F-13
PS530C9W	J-16, J-29	PS560P5W	J-7, J-12, J-17, J-29	PSAD3034	J-26	PSL515C	H-6
PS530C9WL	J-16	PS560P5WR	J-17	PSAD3050	J-26	PSL515CGCM	H-24
PS530CP9WR	J-16	PS560P7S	J-18, J-30	PSAD3050	J-26	PSL515P	H-6
PS530FMIR7W	J-7, J-29	PS560P7W	J-7, J-12, J-17, J-29	PSAD601	J-26	PSL515PGCM	H-24
PS530FMIR9W	J-7, J-29	PS560P7WR	J-17	PSAD60125	J-26	PSL615C	H-7
PS530FMI9W	J-7, J-29	PS560P9S	J-18, J-30	PSAD60150	J-26	PSL615CGCM	H-24
PS530MIR5W	J-12, J-29	PS560P9W	J-7, J-12, J-17, J-29	PSAP30CA	J-21	PSL615P	H-7
PS530MIR7W	J-12, J-29	PS560P9WR	J-17	PSAP320CA	J-21	PSL615PAN	H-7, H-8
PS530MIR9W	J-12, J-29	PS560R5S	J-18, J-30	PSAP320HBL	J-21	PSL615PGCM	H-24
PS530P5S	J-18, J-30	PS560R5W	J-17, J-29	PSAP420HBL	J-21	PSL715C	H-7
PS530P5W	J-12, J-16	PS560R5WL	J-17	PSAP4520CA	J-21	PSL715CGCM	H-24
PS530P5WR	J-16	PS560R7S	J-18, J-30	PSAP52030HBL	J-21	PSL715P	H-7
PS530P7S	J-18, J-30	PS560R7W	J-17, J-29	PSAP60HBL	J-21	PSL715PAN	H-7, H-8
PS530P7W	J-7, J-12, J-16, J-29	PS560R7WL	J-17	PSBB1001W	J-17, J-25, J-26, J-29	PSL715PGCM	H-24
PS530P7WR	J-16	PS560R9S	J-18, J-30	PSBB1002W	J-25, J-26	PSM2FBK	I-3
PS530P9S	J-18, J-30	PS560R9W	J-17, J-29	PSBB201SP	J-18, J-25, J-26	PSM2MBK	I-3
PS530P9W	J-7, J-12, J-16, J-29	PS5666HGAN	E-33, G-4, G-6	PSBB201W	J-16, J-18,	PSMADFMBK	I-3
PS530P9WR	J-16	PS5666SSAN	G-6		J-25, J-26, J-29, J-30	PSMADFMBK	I-3
PS530R5S	J-18, J-30	PS5666X	G-5	PSBB202W	J-16, J-18,	PSMMBK	I-8
PS530R5W	J-16, J-29	PS5666XGCM	G-7		J-25, J-26, J-29, J-30	PSMFCBK	I-3
PS530R5WL	J-16	PS5666XHG	E-33, G-4	PSBB301SP	J-18, J-25, J-26	PSMFR	I-4
PS530R7W	J-16, J-29	PS5666Y	G-8	PSBB301W	J-16, J-18,	PSMFRSBK	I-4
PS530R7WL	J-16	PS5669X	G-5		J-25, J-26, J-29, J-30	PSMMBK	I-8
PS530R9S	J-18, J-30	PS5669XGCM	G-7	PSBB601W	J-17, J-18,	PSMFCBK	I-3
PS530R9W	J-16, J-29	PS5669XHG	E-33, G-4		J-25, J-26, J-29, J-30	PSMMR	I-4
PS530R9WL	J-16	PS5669Y	G-8	PSBBN201W	J-16, J-18,	PSMMRSBK	I-4
PS5362	B-11	PS5766X	B-81, G-5		J-25, J-29, J-30	PSPTBK	I-8
PS5364Y	G-8	PS5866X	B-81, G-5	PSBBN202W	J-16, J-18,	PSTTBK	I-8
PS5366HGAN	E-33, G-4, G-6	PS5965Y	G-8		J-25, J-29, J-30	PSWALLKIT	L-7
PS5366SSAN	G-6	PS5969Y	G-8	PSBBN301W	J-16, J-18,	PT1597HGNTLTRI	B-65, C-16,
PS5366X	G-5	PS6	F-16, F-17, B-82, B-83		J-25, J-29, J-30		E-27

INDEX

P – S

CAT. NO.	PAGE	CAT. NO.	PAGE	CAT. NO.	PAGE	CAT. NO.	PAGE
PT1597HGTRI	C-15, B-64, E-26	PTRA6SOLBP	F-3, F-4, B-4, B-20, E-3, E-18	RC2	P-8	S120HAC	P-11
PT1597NLTTRNAW	C-19, B-68	PTRA6SOLG	F-3, F-4, B-4, B-20, E-3, E-18	RCD11	A-20	S120HGAC	P-11
PT1597HGW	B-63, C-14, E-25	PTRA6SOLNA	B-4	RCD113	A-19, A-20	S120JAC	P-11
PT1597I	C-13, B-62	PTRA6STR	F-3, F-4, F-12, C-13, C-14, C-20, B-4, B-20, B-62, B-63, B-69, E-3, E-18, E-25, E-29	RCD33	A-20	S120JFAN	P-9, P-10
PT1597NAW	C-19, B-68	PTRA6STR25	F-3, F-4, B-4, B-20, E-3, E-18	RCD38TR	A-20	S120JGAC	P-11
PT1597TRI	B-64, C-15	PTRA6STRBP	F-3, F-4, B-4, B-20, E-3, E-18	RCDLM	A-19	S120RAC	P-11
PT15AC1	A-3	PTRA6STRG	F-3, F-4, B-4, B-20, E-3, E-18	RH1103PTC	0-5	S120RACS	P-11
PT15AC3	A-3	PTRA6STRNABL	B-4	RH1103PW	0-5	S120RFAN	P-10
PT2097	C-13, B-62	PTS6SOL3	A-3, A-9	RH4FBL3PTC	0-6, 0-7	S120RGAC	P-11
PT2097HG	C-14, B-63, E-25	PTS6SOL3277	A-3, A-9	RH4FBL3PW	0-6, 0-7	S122B	P-6
PT2097HGNAL	C-20, B-69, E-29	PTS6SOL3BP	A-3, A-9	RH250	N-6	S122R	P-2
PT2097HGNTLTRI	C-16, B-65, E-27	PTS6SOL4	A-3, A-9	RH703PTC	0-5	S122RS	P-7
PT2097HGNTLTRNAI	C-20, B-69, E-29	PTS6SOL4277	A-3, A-9	RH703PTUWC	0-6	S122S50	P-6
PT2097HGTRI	C-15, B-64, E-26	PTS6SOL4BP	A-3, A-9	RH703PTUW	0-6	S122W	P-4
PT2097HGTRNAI	C-20, B-69, E-29	PTS6STR3	A-3, A-9	RH703PW	0-5	S2347	H-26
PT2097NLTTRI	C-16	PTS6STR3277	A-3, A-9	RHCL453PTC	0-6	S2348DF	H-26
PT2097NLTTRNAI	C-19, B-68	PTS6STR3277BP	A-3, A-9	RHCL453PW	0-6	S235RAC	P-2
PT2097TR	C-15, B-64	PTS6STR3BP	A-3, A-9	RHDH163PTC	0-7, 0-27	S235RACMH	P-2
PT2097TRNAI	C-19, B-68	PTS6STR4	A-3, A-9	RHDH163PW	0-7, 0-27	S235RACS	P-7
PT2097NAW	C-19, B-68	PTS6STR4277	A-3, A-9	RHF83PTC	0-7	S235RACSMH	P-7
PT20AC1	A-2, A-3	PTS6STR4277BP	A-3, A-9	RHF83PW	0-7	S235S50AC	P-6
PT20AC1ISL	A-3	PTS6STR4BP	A-3, A-9	RHKIT	0-5	S352W	P-4
PT20AC3	A-3	PTS6STR6	A-3, A-9	RHLV1103PTC	0-5	S354RAC	P-2
PT20AC3ISL	A-3	PTS6STR6277	A-3, A-9	RHLV1103PW	0-5	S354RACS	P-7
PT2601	A-9	PTT6STR3	A-3, A-9	RHLV703PTC	0-5	S354S50AC	P-6
PT2603	A-9	PTT6STR3277	A-3, A-9	RHLV703PW	0-5	S3713	B-77
PT2621	A-9	PTT6STR3277BP	A-3, A-9	RRKCLGV	0-18	S3713TR	B-77
PT2623	A-9	PTT6STR3BP	A-3, A-9	RRW600V	N-4	S3733	B-77
PT26252	B-4	PTT6STR4	A-3, A-9	RRW600U	N-4	S3733SS	B-77
PT2625	A-9	PTT6STR4277BP	A-3, A-9	RS100	M-14, M-18, M-20, M-24	S384C	S-13
PT2626	A-8, A-9	PTT6STR6BP	A-3, A-9	RS100AX	M-14, M-18, M-20, M-24	S3862C	S-14
PT26262HG	B-41, E-18	PTT6STR6277	A-3, A-9	RS30	M-14, M-18, M-20, M-24	S3863C	S-14
PT26352	B-41, E-18	PTT6STR6277BP	A-3, A-9	RS30AX	M-18, M-20, M-24	S40	K-23
PT26362HG	B-41, E-18	PTT6STR6277BP	A-3, A-9	RS30AX3	M-18, M-20, M-24	S4418BAC	P-8
PT5262	B-16	PTT6STR6277BP	A-3, A-9	RS60	M-18, M-20, M-24	S4421RAC	P-8
PT5262A	B-4	PTT6STR6277BP	A-3, A-9	RS60AX	M-18, M-20, M-24	S4421SAC	P-8
PT5262ISP	F-3, B-73	PTT6STR6277BP	A-3, A-9	RS60HP	M-14, M-18, M-20, M-24	S4435RAC	P-8
PT5262SC	B-19	PTT6STR6277BP	A-3, A-9	RS60HPAX	M-14, M-18, M-20, M-24	S4435SAC	P-8
PT5362	B-16, E-11	PTT6STR6277BP	A-3, A-9	RT100	N-23	S468RAC	P-2
PT5362A	B-4	PTT6STR6277BP	A-3, A-9	RT2	N-22	S468RACS	P-7
PT5362AW	B-3, B-4	PTT6STR6277BP	A-3, A-9	RT200	N-23	S468S50AC	P-6
PT5362SC	B-19	PTT6STR6277BP	A-3, A-9	RT50	N-22	S50BRACKET	P-6
PT5362SCI	B-15	PTT6STR6277BP	A-3, A-9	RW600BTC	N-4	S752WCC10	T-5
PT5362SP	F-3, B-73	PTT6STR6277BP	A-3, A-9	RWP26	S-7	S80	K-23
PT8200HI	B-18, E-12	PTT6STR6277BP	A-3, A-9	RWP26NI	S-6	SA1	S-8
PT8200I	B-5, E-4	PTT6STR6277BP	A-3, A-9	RWP262	S-7	SA126	S-15
PT8200IIL	B-6, E-6	PTT6STR6277BP	A-3, A-9	RWP262NI	S-6	SA13	S-11
PT8200SP	F-4, B-73, E-31	PTT6STR6277BP	A-3, A-9	RWP263	S-7	SA14	S-12
PT8300	B-5, E-3, E-4	PTT6STR6277BP	A-3, A-9	RWP263NI	S-6	SA155CC10	T-7
PT8300H	B-18, E-12	PTT6STR6277BP	A-3, A-9	RWP264	S-7	SA2	S-8
PT8300IL	B-6, E-6	PTT6STR6277BP	A-3, A-9	RWP264NI	S-6	SA23	S-11
PT8300SP	F-4, B-73, E-31	PTT6STR6277BP	A-3, A-9	RWP265	S-7	SA24	S-12
PTIG26262	B-41, F-12	PTT6STR6277BP	A-3, A-9	RWP265NI	S-6	SA26	S-9
PTIG26362	B-41, F-12	PTT6STR6277BP	A-3, A-9	RWP266	S-7	SA262	S-10
PTIG5262	B-16, F-12	PTT6STR6277BP	A-3, A-9	RWP266NI	S-6	SA3	S-8
PTIG5262WSP	B-73, F-3	PTT6STR6277BP	A-3, A-9	RWU600B	N-4	SA399BKCC10	T-7
PTIG5362	B-16, F-11, F-12	PTT6STR6277BP	A-3, A-9	RT	N-22	SA4	S-8
PTIG5362ISP	B-73, F-3	PTT6STR6277BP	A-3, A-9	SA7	S-13	SA440CC10	T-7
PTIG8200	B-16, E-11, F-12	PTT6STR6277BP	A-3, A-9	SA716	S-14	SA540CC10	T-7
PTIG8200LASP	B-73, E-31, F-4	PTT6STR6277BP	A-3, A-9	SA78	S-17	SA7	S-13
PTIG8300	B-16, E-11, F-12	PTT6STR6277BP	A-3, A-9	SA8	S-9	SA716	S-14
PTIG8300SP	B-73, E-31, F-4	PTT6STR6277BP	A-3, A-9	SA82	S-9	SA78	S-17
PTJ	A-3, A-9	PTT6STR6277BP	A-3, A-9	SA840CC10	T-7	SA8	S-9
PTJ5	A-3, A-9	PTT6STR6277BP	A-3, A-9	SA993BKCC10	T-7	SA82	S-9
PTRA6SOL	F-3, F-4, F-12, C-13, C-14, C-20, B-4, B-20, B-62, B-63, B-69, E-3, E-18, E-25, E-29	PTT6STR6277BP	A-3, A-9	SB126PB	S-15	SA840CC10	T-7
PTRA6SOLB25	F-3, F-4, B-4, B-20, E-3, E-18	PTT6STR6277BP	A-3, A-9	SB13BZ	S-11	SA993BKCC10	T-7
		PTT6STR6277BP	A-3, A-9	SB13CH	S-11	SB126PB	S-15
		PTT6STR6277BP	A-3, A-9	SB13PB	S-11	SB13BZ	S-11
		PTT6STR6277BP	A-3, A-9			SB13CH	S-11
		PTT6STR6277BP	A-3, A-9			SB13PB	S-11

R

S

INDEX

S

CAT. NO.	PAGE	CAT. NO.	PAGE	CAT. NO.	PAGE	CAT. NO.	PAGE
SB182PB.....	S-18	SLV2B.....	P-5	SPJ7.....	S-22	SS3.....	S-8
SB18PB.....	S-15	SLV2W.....	P-5	SPJ8.....	S-22	SS314.....	S-16
SB1BZ.....	S-8	SLV3W.....	P-5	SPJ82.....	S-22	SS326.....	S-15
SB1CH.....	S-8	SMTE14I.....	S-30	SPJ826I.....	S-24	SS33.....	S-11
SB1PB.....	S-8	SP1.....	S-8	SP01.....	S-22	SS33.5.....	S-11
SB23BZ.....	S-11	SP11.....	S-32	SP0113.....	S-24	SS34.....	S-12
SB23CH.....	S-11	SP112.....	S-17, S-34	SP013.....	S-23	SS38.....	S-15
SB23PB.....	S-11	SP12.....	S-32	SP01326.....	S-24	SS38.5.....	S-15
SB26.....	F-5	SP1214I.....	S-17, S-34	SP0138.....	S-24	SS38PB.....	S-15
SB262PB.....	S-10	SP1226.....	S-17, S-34	SP018.....	S-24	SS4.....	S-8
SB263PB.....	S-10	SP126.....	S-15	SP02.....	S-22	SS43.....	S-11
SB264PB.....	S-10	SP1262.....	S-15	SP023.....	S-23	SS44.....	S-12
SB26BZ.....	S-9	SP128.....	S-17, S-34	SP026.....	S-23	SS48.....	S-15
SB26CH.....	S-9	SP13.....	S-11	SP0262.....	S-23	SS5.....	S-8
SB26PB.....	S-9	SP138.....	S-17	SP08.....	S-22	SS53.....	S-11
SB28PB.....	S-15	SP14.....	S-12	SP082.....	S-22	SS6.....	S-8
SB2BZ.....	S-8	SP1426.....	S-18	SRK0500F.....	K-29	SS601.....	S-8
SB2CH.....	S-8	SP147I.....	S-18	SRK0620F.....	K-29	SS6013.....	S-11
SB2PB.....	S-8	SP148.....	S-18	SRK0750F.....	K-29	SS602.....	S-8
SB33PB.....	S-11	SP17.....	S-17	SRK1000F.....	K-29	SS6023.....	S-11
SB3BZ.....	S-8	SP18.....	S-15	SRK1250F.....	K-29	SS63.....	S-11
SB3CH.....	S-8	SP182.....	S-18	SRK1500F.....	K-29	SS7.....	B-78, H-35, S-13
SB3PB.....	S-8	SP2.....	S-8	SRK1750F.....	K-29	SS701.....	B-78, S-14
SB4PB.....	S-8	SP21I.....	S-32	SRK2000F.....	K-29	SS702.....	B-78, S-14
SB5PB.....	S-8	SP226.....	S-15	SRK2500F.....	K-29	SS703.....	S-14
SB6PB.....	S-8	SP2262.....	S-16	SRK3000F.....	K-29	SS705.....	S-14
SB7PB.....	S-13	SP23.....	S-11	SRK3500F.....	K-29	SS710.....	S-14
SB826PB.....	S-17	SP24.....	S-12	SS1.....	S-8	SS716.....	S-14
SB82BZ.....	S-9	SP26.....	S-9	SS11.....	S-32	SS717.....	S-20
SB82CH.....	S-9	SP262.....	S-10	SS113.....	S-17	SS72.....	S-13
SB82PB.....	S-9	SP263I.....	S-10	SS114.....	S-16	SS720.....	H-9, H-10, H-11, H-12, H-14, H-16, H-17, H-18, H-19, H-20, H-21, H-22, H-27, H-28, H-35, S-13
SB83PB.....	S-9	SP264.....	S-10	SS12.....	S-32	SS721.....	S-13
SB84PB.....	S-9	SP265I.....	S-10	SS1214.....	S-17, S-34	SS723.....	S-13
SB8BZ.....	S-9	SP266.....	S-10	SS1226.....	S-17, S-34	SS724.....	S-13
SB8CH.....	S-9	SP28.....	S-15	SS126.....	S-15	SS725.....	S-13
SB8PB.....	S-9	SP3.....	S-8	SS1262.....	S-15	SS727.....	S-20
SCK0751.....	K-29	SP326.....	S-15	SS128.....	S-17, S-34	SS73.....	S-13
SCK1001.....	K-29	SP33.....	S-11	SS13.....	S-11	SS730.....	S-32
SCK1251.....	K-29	SP38.....	S-15	SS13.5.....	S-11	SS736.....	S-32
SCK1501.....	K-29	SP4.....	S-8	SS138.....	S-17	SS740.....	S-20
SCK1502.....	K-29	SP43.....	S-11	SS14.....	S-12	SS741.....	S-34
SCK1751.....	K-29	SP44.....	S-12	SS14.5.....	S-12	SS742.....	S-34
SCK2002.....	K-29	SP5.....	S-8	SS14114.....	S-18	SS743.....	S-20
SCK2501.....	K-29	SP60I.....	S-32	SS1426.....	S-18	SS746.....	S-20
SCK2502.....	K-29	SP6I.....	S-8	SS147.....	S-18	SS747.....	S-20
SCK3001.....	K-29	SP7.....	S-13	SS148.....	S-18	SS748.....	S-20
SCK3002.....	K-29	SP703.....	S-14	SS14814.....	S-18	SS751.....	S-33
SCK3501.....	K-29	SP72.....	S-13	SS17.....	S-17	SS752.....	S-33
SDV2B.....	P-5	SP720.....	S-13	SS18.....	S-15	SS753.....	S-33
SH122B.....	P-6	SP732.....	S-32	SS182.....	S-18	SS754.....	S-33
SH26.....	S-26	SP78.....	S-17	SS1GBRED.....	S-39	SS760.....	S-21
SHL100.....	A-23, B-33	SP8.....	S-9	SS2.....	S-8	SS771.....	S-21
SHL20.....	A-23, B-33	SP82.....	S-9	SS21.....	S-32	SS772.....	S-21
SL1.....	S-8	SP826.....	S-17	SS214.....	S-16	SS78.....	S-17
SL12.....	S-32	SP83.....	S-9	SS22.....	S-32	SS785.....	S-33
SL13.....	S-11	SP84.....	S-9	SS226.....	S-15	SS787.....	S-33
SL14.....	S-12	SPJ1.....	S-22	SS23.....	S-11	SS791.....	S-34
SL2.....	S-8	SPJ113.....	S-24	SS23.5.....	S-11	SS792.....	S-34
SL23.....	S-11	SPJ11I.....	S-34	SS24.....	S-12	SS8.....	H-35, S-9
SL24.....	S-12	SPJ126.....	S-24	SS24.5.....	S-12	SS8148.....	S-18
SL26.....	S-9	SPJ13.....	S-23	SS26.....	F-5, S-9	SS82.....	S-9
SL262.....	S-10	SPJ138.....	S-24	SS262.....	S-10	SS826.....	S-17
SL3.....	S-8	SPJ1426.....	S-24	SS263.....	S-10	SS82IG.....	S-38
SL4.....	S-8	SPJ18.....	S-24	SS264.....	S-10	SS83.....	S-9
SL7.....	S-13	SPJ2.....	S-22	SS265.....	S-10	SS84.....	S-9
SL8.....	S-9	SPJ26.....	S-23	SS266.....	S-10	SS85.....	S-9
SL82.....	S-9	SPJ262.....	S-23	SS267.....	S-10	SS86.....	S-9
SLV1B.....	P-5	SPJ263.....	S-23	SS268.....	S-10	SS8EE.....	S-38
SLV1R.....	P-5	SPJ264.....	S-23	SS26IG.....	F-5, S-38		
SLV1S.....	P-5	SPJ3.....	S-22	SS28.....	S-15		
SLV1W.....	P-5	SPJ4.....	S-22	SS282.....	S-18		

INDEX

S – W

CAT. NO.	PAGE	CAT. NO.	PAGE	CAT. NO.	PAGE	CAT. NO.	PAGE	
SS8ERED	S-38	STB38SF	K-16	TM8LMCC	0-10, 0-28	TPJ8	S-22	
SS8ES	S-38	STB45100SF	K-16	TM8LOCATOR	A-23	TPJ82	S-22	
SS8IG	S-38	STB45125SF	K-16	TM8USB4ICC6	A-21, B-37	TPJ826	S-24	
SS9	S-21	STB45200SF	K-16	TM8USBICC6	B-37	TPTE1	S-29	
SSJ1	S-22	STB45250SF	K-16	TP1	S-8	TPTE2	S-29	
SSJ126	S-24	STB45300SF	K-16	TP11	S-32	TPTELV	S-31	
SSJ13	S-23	STB4538SF	K-16	TP113	S-17	TR15	B-32	
SSJ18	S-24	STB4550SF	K-16	TP12	S-32	TR20	B-32	
SSJ2	S-22	STB4575SF	K-16	TP126	S-15	TR26242	B-45	
SSJ26	S-23	STB50SF	K-16	TP13	S-11	TR26252	B-45	
SSJ262	S-23	STB75SF	K-16	TP138	S-17	TR26261	B-47	
SSJ263	S-23	STB90100SF	K-16	TP14	S-12	TR26261HG	B-47	
SSJ3	S-22	STB90125SF	K-16	TP18	S-15	TR26262	B-46	
SSJ7	S-22	STB90150SF	K-16	TP1ERED	S-38	TR26262HG	B-46, E-20	
SSJ8	S-22	STB90200SF	K-16	TP2	S-8	TR26262HGPI	E-20	
SSJ82	S-22	STB90300SF	K-16	TP226	S-15	TR26342	B-45	
SSK0751	K-29	STB9050SF	K-16	TP23	S-11	TR26352	B-45	
SSK1	S-19	STB9075SF	K-16	TP24	S-12	TR26361	B-47	
SSK1002	K-29	STBN100SF	K-16	TP26	S-9	TR26361HG	B-47	
SSK12	S-19	STBN125SF	K-16	TP262	S-10	TR26362	B-46	
SSK1251	K-29	STBN150SF	K-16	TP263	S-10	TR26362HG	B-46, E-20	
SSK1252	K-29	STBN200SF	K-16	TP264	S-10	TR26362HGPI	E-20	
SSK13	S-19	STBN38SF	K-16	TP265	S-10	TR5251	B-33	
SSK1501	K-29	STBN50SF	K-16	TP266	S-10	TR5252	B-32	
SSK1502	K-29	STBN75SF	K-16	TP26BL	F-5	TR5261USB	B-38	
SSK1751	K-29	SWP26	S-2, S-7	TP26CO	S-39	TR5262	B-31	
SSK2	S-19	SWP262	S-7	TP26ERED	S-39	TR5262SP	B-74, F-7	
SSK2001	K-29	SWP263	S-7	TP26IG	F-5, S-39	TR5262USB	B-39	
SSK2002	K-29	SWP264	S-7	TP28	S-15	TR5351	B-33	
SSK22	S-19	T			TP2ERED	S-38	TR5352	B-32
SSK2502	K-29	T1000	0-17	TP3	S-8	TR5361USB	B-38	
SSK3	S-19	T1000L	0-17	TP4	S-8	TR5362	B-31	
SSK3001	K-29	T1003	0-17	TP5	S-8	TR5362SP	B-74, F-7	
SSK3002	K-29	T1003LI	0-17	TP6	S-8	TR5362USB	B-39	
SSK32	S-19	T600	0-17	TP60I	S-32	TR62	B-29	
SSK33	S-19	T600L	0-17	TP7	S-13	TR62H	B-30, E-14	
SSK3501	K-29	T603	0-17	TP703	B-78, S-14	TR63	B-29	
SSMF	M-9	T603LI	0-17	TP720	S-13	TR63H	B-30, E-14	
SSMF2	M-9	TD1103P	0-15	TP724	B-78, S-13	TR8200H	B-14, E-14	
SSN14	S-27	TD703P	0-15	TP7CO	S-39	TR8200HPI	B-30, E-15	
SSN15	S-27	TDCL453P	0-15	TP7IG	S-38	TR8200HUSB	B-39, E-21	
SSO1	S-22	TDDH163P	0-16, 0-29	TP8	S-9	TR8200PI	B-30, E-15	
SSO11	S-34	TDFB83P	0-16	TP82	S-9	TR8200SP	B-74, E-32, F-9	
SSO114	S-24	TDLV1103P	0-16	TP826	S-17	TR8201	B-26, E-13	
SSO12	S-34	TDLV703P	0-16	TP82ERED	S-38	TR8300H	B-14, E-14	
SSO126	S-24	TLV1000	0-17	TP8CO	S-39	TR8300HPI	B-30, E-15	
SSO13	S-23	TLV1003I	0-17	TP8EMPOWER	S-39	TR8300HUSB	B-39, E-21	
SSO138	S-24	TLV600	0-17	TP8ERED	S-38	TR8300ISP	B-74, E-32, F-9	
SSO14	S-23	TLV603I	0-17	TP8GFI	S-39	TR8300PI	B-30, E-15	
SSO18	S-24	TM1542BOX	P-17	TP8IG	S-38	TR8301	B-26, E-13	
SSO2	S-22	TM1542TRBR	P-17	TPCATV	S-31	TRIG26262	B-36, F-14	
SSO23	S-23	TM1542TRCF	P-17	TPCATV2	S-31	TRIG26262HGI	B-36, E-17, F-14	
SSO24	S-23	TM1542TRW	P-17	TPD1	T-17	TRIG26362	B-36, F-14	
SSO26	S-23	TM8113WCC	A-20	TPD2	T-17	TRIG26362HG	B-36, E-17, F-14	
SSO262	S-23	TM811DTMA	A-11	TPD3	T-17	TRIG5262	B-36, E-17, F-14	
SSO28	S-24	TM811DTMO	A-11	TPD4	T-17	TRIG5262WSP	B-74, F-7	
SSO3	S-22	TM826USBICC6	A-21, B-37	TPD6	T-17	TRIG5362	B-36, E-17, F-14	
SSO33	S-23	TM83USBICC6	A-21, B-37	TPD9	T-17	TRIG5362WSP	B-74, F-7	
SSO34	S-23	TM870	A-14	TPJ1	S-22	TRIG8200	B-36, E-17, F-14	
SSO4	S-22	TM870ISL	A-15	TPJ113	S-24	TRIG8200WSP	B-74, E-32, F-9	
SSO7	S-22	TM870NA	A-14	TPJ126	S-24	TRIG8300	B-36, E-17, F-14	
SSO8	S-22	TM870S	A-15	TPJ13	S-23	TRIG8300ISP	B-74, E-32, F-9	
SSO82	S-22	TM870STM	A-11	TPJ18	S-24	TSC5	0-17, 0-29	
SSO83	S-22	TM873	A-14	TPJ2	S-22	TV1WBK	P-18	
SSTK424	S-26	TM873ISL	A-15	TPJ26	S-23	TV1WLA	P-18	
STB100SF	K-16	TM873NA	A-14	TPJ262	S-23	TV1WMLVKIT	P-18	
STB125SF	K-16	TM873S	A-15	TPJ263	S-23	TV1WMTVSSWCC2	P-18	
STB150SF	K-16	TM874	A-14	TPJ264	S-23	TV1WTVSSBK	P-18	
STB200SF	K-16	TM874ISL	A-15	TPJ3	S-22	TV1WTVSSLA	P-18	
STB250SF	K-16	TM874S	A-15	TPJ4	S-22	TV1WTVSSW	P-18	
STB300SF	K-16			TPJ7	S-22	TV1WW	P-18	

INDEX

W

CAT. NO.	PAGE	CAT. NO.	PAGE	CAT. NO.	PAGE	CAT. NO.	PAGE
TV2MBK	P-18	WPB373	R-18	WSCL453W	0-14	0 511 61	J-20
TV3W	P-18	WPB382	R-17	WSDH16TC	0-29	0 511 76	J-20
TV3WMTTVSSW	P-18	WPB387	R-17	WSDH16W	0-29	0 511 80	J-20
TV3WTVSS	P-18	WPBD23	R-18	WSKIT	0-13	0 511 81	J-20
TV3WTVSSW	P-18	WPBD252	R-18	WSKITP	0-13	0 511 86	J-20
TV3WW	P-18	WPBD33	R-18	WSLV700TC	0-13	0 511 90	J-20
		WPBD352	R-18	WSLV700W	0-13	0 511 91	J-20
		WPBD43	R-18	WSLV703PTC	0-13	0 520 89	J-20
		WPBD452	R-18	WSLV703PW	0-13	0 522 89	J-20
		WPBJ22	R-21	WSSC53PTC	0-13, 0-29	0 522 89	J-20
		WPBL100	R-22	WSSC53PW	0-13, 0-29	0 529 90	J-20
		WPBP100	R-22	WT100562M	K-13	0 529 90	J-20
		WPBP50	R-22	WT100562NM	K-13	0 529 90	J-20
		WPBP75	R-22	WT100625M	K-13	0 530 06	J-20
		WPD8	S-28	WT100625NM	K-13	0 530 10	J-20
		WPEX1	R-22	WT100750M	K-13	0 530 11	J-20
		WPEX2	R-22	WT100750NM	K-13	0 530 46	J-20
		WPEX3	R-22	WT100812M	K-13	0 530 50	J-20
		WPEX4	R-22	WT100875M	K-13	0 530 51	J-20
		WPEX5	R-22	WT100875NM	K-13	0 530 56	J-20
		WPEX6	R-22	WT1105	N-17	0 530 60	J-20
		WPFLDKITW	R-19	WT2205	N-17	0 530 61	J-20
		WPG1	R-2, R-12, G-10	WT50312M	K-13	0 530 76	J-20
			H-30, H-35, R-2, R-12	WT50312NM	K-13	0 530 80	J-20
		WPG2	H-9, H-10, H-11, H-12,	WT50375M	K-13	0 530 81	J-20
			H-14, H-16, H-17, H-18,	WT50375NM	K-13	0 530 86	J-20
			H-19, H-20, H-21, H-22,	WT50437M	K-13	0 530 90	J-20
			H-27, H-28, H-35, R-2, R-12	WT50437NM	K-13	0 530 91	J-20
		WPGAS100	R-22	WT50500M	K-13	0 538 89	J-20
		WPGAS101	R-22	WT50562M	K-13	0 538 89	J-20
		WPGASR101	R-22	WT605	N-17	0 553 48	J-39
		WPGFIKIT	R-19	WT75375M	K-13	0 564 53	J-38
		WPH1L	S-28	WT75437M	K-13	0 564 57	J-38
		WPH26	S-28	WT75437NM	K-13	0 564 58	J-38
		WPH7L	S-28	WT75375M	K-13	0 564 73	J-38
		WPH8	S-28	WT75437M	K-13	0 564 77	J-38
		WPH8L	S-28	WT75437NM	K-13	0 564 78	J-38
		WPLKIT1	R-21	WT75500M	K-13	0 565 03	J-39
		WPLKIT2	R-21	WT75500NM	K-13	0 565 23	J-39
		WPLKIT3	R-21	WT75562M	K-13	0 565 28	J-39
		WPLKIT4	R-21	WT75562NM	K-13	0 568 00	J-39
		WPOUTKIT	R-19	WT75620NM	K-13	0 568 03	J-39
		WPRB1	R-20	WT75625M	K-13	0 568 04	J-39
		WPRB11	R-20	WT75625NM	K-13	0 568 07	J-39
		WPRB12	R-20	WT75687M	K-13	0 568 08	J-39
		WPRB13	R-20	WT75680M	K-13	0 568 23	J-39
		WPRB25	R-19			0 568 27	J-39
		WPRB35	R-19			0 568 28	J-39
		WPWIUKITW	R-19	0 221 71	M-23	0 573 00	J-38
		WR20TR	B-34	0 221 72	M-23	0 573 01	J-38
		WR5262	B-34	0 221 73	M-23	0 573 02	J-38
		WR5362	B-34	0 221 74	M-23	0 573 20	J-39
		WR5662	B-34	0 221 75	M-23	0 573 21	J-39
		WR5862	B-34	0 221 76	M-23	0 573 22	J-39
		WS1100TC	0-13	0 221 77	M-23	0 573 51	J-38
		WS1100W	0-13	0 221 79	M-23	0 573 54	J-38
		WS1103PTC	0-13	0 221 88	M-23	0 573 58	J-38
		WS1103PW	0-13	0 221 89	M-23	0 573 59	J-38
		WS250	N-8	0 222 82	M-23	0 575 81	J-38
		WS301	N-11	0 227 00	M-23	0 575 84	J-38
		WS4FBL3PTC	0-14	0 511 06	J-20	0 575 85	J-38
		WS4FBL3PW	0-14	0 511 10	J-20	0 575 86	J-38
		WS700TC	0-13	0 511 11	J-20	0 575 88	J-38
		WS700W	0-13	0 511 26	J-20	0 575 89	J-38
		WS703PTC	0-13	0 511 30	J-20	0 580 54	J-38
		WS703PW	0-13	0 511 31	J-20	0 580 58	J-38
		WSCL450TC	0-14	0 511 46	J-20	0 580 59	J-38
		WSCL450W	0-14	0 511 50	J-20	0 582 81	J-38
		WSCL453PTC	0-14	0 511 51	J-20	0 582 84	J-38
		WSCL453PW	0-14	0 511 56	J-20	0 582 86	J-38
		WSCL453TC	0-14	0 511 60	J-20	0 582 88	J-38

INDEX

CAT. NO.	PAGE	CAT. NO.	PAGE	CAT. NO.	PAGE	CAT. NO.	PAGE
0 582 89.....	J-38	5 551 09.....	J-38	5 552 92.....	J-38	14W48AM.....	L-11
0 587 00.....	J-39	5 551 10.....	J-38	5 552 93.....	J-38	14W49.....	L-4
0 587 01.....	J-39	5 551 12.....	J-38	5 553 01.....	J-39	14W49AM.....	L-11
0 587 02.....	J-39	5 551 13.....	J-38	5 553 04.....	J-39	15W07.....	L-4
0 587 04.....	J-39	5 551 21.....	J-38	5 553 05.....	J-39	15W33.....	L-4
0 587 05.....	J-39	5 551 22.....	J-38	5 553 06.....	J-39	15W33AM.....	L-11
0 587 07.....	J-39	5 551 24.....	J-38	5 553 08.....	J-39	15W33GCM.....	L-4
0 587 10.....	J-39	5 551 25.....	J-38	5 553 09.....	J-39	15W47.....	L-4
0 587 11.....	J-39	5 551 26.....	J-38	5 553 12.....	J-39	15W47AM.....	L-11
0 587 12.....	J-39	5 551 27.....	J-38	5 553 21.....	J-39	15W47GCM.....	L-4
0 587 14.....	J-39	5 551 28.....	J-38	5 553 24.....	J-39	15W48.....	L-4
0 587 15.....	J-39	5 551 29.....	J-38	5 553 25.....	J-39	15W48AM.....	L-11
0 587 17.....	J-39	5 551 30.....	J-38	5 553 26.....	J-39	15W49.....	L-4
0 587 20.....	J-39	5 551 32.....	J-38	5 553 28.....	J-39	15W49AM.....	L-11
0 587 21.....	J-39	5 551 33.....	J-38	5 553 29.....	J-39	24W34.....	L-5
0 587 22.....	J-39	5 551 51.....	J-38	5 553 32.....	J-39	24W34AM.....	L-11
0 587 24.....	J-39	5 551 52.....	J-38	5 553 51.....	J-39	24W47.....	L-5
0 587 25.....	J-39	5 551 54.....	J-38	5 553 54.....	J-39	24W47AM.....	L-11
0 587 27.....	J-39	5 551 55.....	J-38	5 553 55.....	J-39	24W49.....	L-5
0 587 30.....	J-39	5 551 56.....	J-38	5 553 56.....	J-39	24W49AM.....	L-11
0 587 34.....	J-39	5 551 57.....	J-38	5 553 58.....	J-39	25W34.....	L-5
0 587 35.....	J-39	5 551 58.....	J-38	5 553 59.....	J-39	25W34AM.....	L-11
0 587 40.....	J-39	5 551 59.....	J-38	5 553 62.....	J-39	25W47.....	L-5
0 587 41.....	J-39	5 551 60.....	J-38	5 553 81.....	J-39	25W47AM.....	L-11
0 587 42.....	J-39	5 551 62.....	J-38	5 553 84.....	J-39	25W49.....	L-5
0 587 44.....	J-39	5 551 63.....	J-38	5 553 85.....	J-39	25W49AM.....	L-11
0 587 45.....	J-39	5 551 81.....	J-38	5 553 86.....	J-39	26CATVI.....	S-31
0 591 06.....	J-39	5 551 84.....	J-38	5 553 88.....	J-39	26TE14I.....	S-29
0 591 07.....	J-39	5 551 85.....	J-38	5 553 89.....	J-39	26TE16I.....	S-29
0 591 14.....	J-20	5 551 86.....	J-38	5 553 92.....	J-39	26TE24I.....	S-30
0 591 15.....	J-20	5 551 88.....	J-38	5 554 14.....	J-39	26TE26I.....	S-30
0 591 16.....	J-39	5 551 90.....	J-38	5 554 15.....	J-39	26TELVICC10.....	S-31
0 591 17.....	J-39	5 551 92.....	J-38	5 554 16.....	J-39	26W08.....	L-6
0 591 26.....	J-39	5 551 93.....	J-38	5 554 18.....	J-39	26W08AM.....	L-11
0 591 27.....	J-39	5 552 11.....	J-38	5 554 19.....	J-39	26W47.....	L-5
0 591 36.....	J-39	5 552 14.....	J-38	5 554 21.....	J-39	26W47AM.....	L-11
0 591 37.....	J-39	5 552 15.....	J-38	5 554 22.....	J-39	26W48.....	L-5
0 591 46.....	J-39	5 552 16.....	J-38	5 554 31.....	J-39	26W48AM.....	L-11
0 591 47.....	J-39	5 552 17.....	J-38	5 554 34.....	J-39	26W49.....	L-5
0 594 27.....	J-20	5 552 18.....	J-38	5 554 35.....	J-39	26W49AM.....	L-11
0 594 28.....	J-20	5 552 19.....	J-38	5 554 36.....	J-39	26W74.....	L-6
0 594 37.....	J-20	5 552 20.....	J-38	5 554 38.....	J-39	26W74AM.....	L-11
0 594 38.....	J-20	5 552 22.....	J-38	5 554 39.....	J-39	26W75.....	L-6
0 594 47.....	J-20	5 552 23.....	J-38	5 554 41.....	J-39	26W75AM.....	L-11
0 594 48.....	J-20	5 552 31.....	J-38	5 554 42.....	J-39	26W76.....	L-6
0 594 77.....	J-20	5 552 34.....	J-38	5 554 43.....	J-39	26W76AM.....	L-11
0 594 78.....	J-20	5 552 35.....	J-38	5 554 51.....	J-39	27W08.....	L-6
0 594 87.....	J-20	5 552 36.....	J-38	5 554 54.....	J-39	27W08AM.....	L-11
0 594 88.....	J-20	5 552 37.....	J-38	5 554 55.....	J-39	27W47.....	L-5
0 595 02.....	J-20	5 552 38.....	J-38	5 554 56.....	J-39	27W47AM.....	L-11
0 595 03.....	J-20	5 552 39.....	J-38	5 554 58.....	J-39	27W48.....	L-5
0 595 12.....	J-20	5 552 40.....	J-38	5 554 59.....	J-39	27W48AM.....	L-11
0 595 13.....	J-20	5 552 42.....	J-38	5 554 62.....	J-39	27W49.....	L-5
0 595 22.....	J-20	5 552 43.....	J-38	5 554 63.....	J-39	27W49AM.....	L-11
0 595 23.....	J-20	5 552 51.....	J-38	5 554 81.....	J-39	27W74.....	L-6
0 595 32.....	J-20	5 552 54.....	J-38	5 554 84.....	J-39	27W74AM.....	L-11
0 595 33.....	J-20	5 552 55.....	J-38	5 554 85.....	J-39	27W75.....	L-6
0 595 42.....	J-20	5 552 56.....	J-38	5 554 86.....	J-39	27W75AM.....	L-11
0 595 43.....	J-20	5 552 57.....	J-38	5 554 88.....	J-39	27W76.....	L-6
4AP.....	B-75	5 552 58.....	J-38	5 554 89.....	J-39	27W76AM.....	L-11
4RBC.....	P-11	5 552 59.....	J-38	5 554 91.....	J-39	28W08.....	L-6
4RBCW.....	P-11	5 552 60.....	J-38	5 554 92.....	J-39	28W08AM.....	L-11
4SBC.....	P-8	5 552 62.....	J-38	5SC.....	T-9	28W09.....	L-6
4SBCW.....	P-8	5 552 63.....	J-38	14W07.....	L-4	28W09AM.....	L-11
5 551 01.....	J-38	5 552 81.....	J-38	14W33.....	L-4	28W47.....	L-5
5 551 02.....	J-38	5 552 84.....	J-38	14W33AM.....	L-11	28W47AM.....	L-11
5 551 04.....	J-38	5 552 85.....	J-38	14W33GCM.....	L-4	28W48.....	L-5
5 551 05.....	J-38	5 552 86.....	J-38	14W47.....	L-4	28W48AM.....	L-11
5 551 06.....	J-38	5 552 88.....	J-38	14W47AM.....	L-11	28W49.....	L-5
5 551 07.....	J-38	5 552 89.....	J-38	14W47GCM.....	L-4	28W49AM.....	L-11
5 551 08.....	J-38	5 552 90.....	J-38	14W48.....	L-4	28W74.....	L-6

INDEX

CAT. NO.	PAGE	CAT. NO.	PAGE	CAT. NO.	PAGE	CAT. NO.	PAGE
28W74AM	L-11	210G	T-8	692	A-17	1548	L-2
28W75	L-6	220	T-2	692G	A-16	1549	L-2
28W75AM	L-11	226PAI	T-9	693	A-17	1575	T-11
28W76	L-6	272	T-4	693G	A-16	1594CMA	C-22
28W76AM	L-11	272WH6	T-4	695	A-17	1594CMM	C-22
28W77	L-6	274	T-4	695G	A-16	1594CS1A	C-23
28W77AM	L-11	276WH	T-4	696	A-17	1594CS1M	C-23
29W08	L-6	276WH6	T-4	696G	A-16	1594PC2A	C-23
29W08AM	L-11	277FL	T-4	697	T-9	1594PC2M	C-23
29W09	L-6	278FL	T-4	697RI	T-9	1594PC6M	C-23
29W09AM	L-11	280WH	T-4	699CC25	T-9	1594TC2A	C-23
29W47	L-5	280WH6	T-4	735CC10	T-9	1594TC2M	C-23
29W47AM	L-11	282	T-4	738	T-2	1594TL2A	C-23
29W48	L-5	284	T-4	779CC5	T-9	1594TL2M	C-23
29W48AM	L-11	288	T-4	885	B-52	1594TPA	B-70, C-21
29W49	L-5	325	T-10	885S	B-52	1597	B-57, C-5
29W49AM	L-11	326	S-35, T-10	885TR	B-50	1597HGI	B-58, C-6, E-22
29W74	L-6	327	S-35, T-10	885TRSI	B-50	1597HGNTLTR	E-24
29W74AM	L-11	340	S-35	885TRWR	B-51	1597HGTR	B-56, C-4, E-22
29W75	L-6	341DU4	T-6	975ABDCC10	T-5	1597HGTRA	C-11, E-23
29W75AM	L-11	342	S-35, T-12	1031	B-78, G-12	1597IGHGTRO	C-12, E-23
29W76	L-6	347	S-35, T-12	1033	G-12	1597IGTRI	C-12
29W76AM	L-11	348	S-35, T-12	1038	T-15	1597NTLTR	B-60, C-9
29W77	L-6	384	S-13	1039	T-15	1597SWTTR	A-22, B-59, C-8
29W77AM	L-11	385	B-78	1050K	T-14	1597TR	B-55, C-2, C-3, C-11
60W07	L-4	388	B-78	1051	B-78, G-12	1597TRA	C-11
60W33	L-4	405RED	S-35	1053	B-78, G-12	1597TRNA	B-66, C-17
60W33DPLX	L-4	406RED	S-35	1070B	T-14	1597TRRI	B-70, C-21
60W47	L-4	410WCC25	T-2	1081	T-14	1597TRWR	B-61, C-10
60W47DPLX	L-4	415	B-75	1091	T-14	1597TRWRNA	B-66, C-17
60W48	L-4	420	B-75	1200	A-23	2005	T-6
60W48DPLX	L-4	420BLSP	B-75	1201	A-23	2006	T-6
60W49	L-4	420H	B-75, E-34	1205A	A-23	2087	C-7
60W49DPLX	L-4	423	T-2	1206A	A-23	2094PC2A	C-23
61	T-5	464	T-3	1221	A-28, M-6	2094PC2M	C-23
63	T-8	465	T-3	1222	A-28, M-6	2094TL2A	C-23
65W34	L-5	466	T-3	1225	A-28, M-6	2094TL2M	C-23
65W34DPLX	L-5	467	T-3	1226	A-28, M-6	2097	C-5, B-57
65W47	L-5	500K	A-5, T-14	1227	A-28, M-6	2097HG	B-58, C-6, E-22
65W47DPLX	L-5	509	S-37	1228	A-28, M-6	2097HGNAI	B-67, C-18, E-28
65W49	L-5	510	S-37	1250	A-28, M-6	2097HGNTLTR	B-60, C-9
65W49DPLX	L-5	511	S-37	1251	A-28, M-6	2097HGNTLTRI	E-24
67W08	L-6	512	S-37	1255	A-28, M-6	2097HGTR	B-56, C-4, E-22
67W47	L-5	513	S-37	1256	A-28, M-6	2097HGTRAI	C-11, E-23
67W48	L-5	528I	S-37	1264	T-8	2097HGTRNAI	B-67, C-18, E-28
67W49	L-5	531S	S-37	1275	A-28, M-6	2097IGHGTTRI	C-12
67W74	L-6	532S	S-37	1276	A-28, M-6	2097IGHGTRO	E-23
67W75	L-6	533D	S-37	1332	T-11	2097IGTRI	C-12
67W76	L-6	575	T-2	1354	T-12	2097NA	B-66, C-17
68	T-8	653	T-2	1375	T-11	2097NTLTR	B-60, C-9
69W	T-8	660G	A-12	1376	T-11	2097TR	B-55, C-3, C-11
69W08	L-6	660GMH	A-12	1377	T-11	2097TRRI	B-70, C-21
69W09	L-6	660ISLG	A-13	1406	T-8	2097TRWR	B-66, C-10
69W47	L-5	660NAG	A-12	1431	B-78, G-12	2097TRNAI	B-66, C-17
69W48	L-5	660SG	A-13	1432	T-11	2097TRWRNAI	B-66, C-17
69W49	L-5	663G	A-12	1433	T-11	2151RED	S-36
69W74	L-6	663ISLG	A-13	1433P	L-2	2152	S-36
69W75	L-6	663SG	A-13	1447	L-2	2156	S-36
69W76	L-6	664G	A-12	1448	L-2	2434	L-3
69W77	L-6	664SG	A-13	1449	L-2	2447	L-3
83CC4	T-7	670	A-17	1451	B-78, G-12	2449	L-3
84BKCC20	T-7	670G	A-16	1475	T-11	2534	L-3
101	T-7	671	A-16	1482ICC10	T-8	2536	T-3
111GMC	T-7	671TR	A-16	1498	A-5, A-28, M-6	2537	T-3
111MC	T-7	680I	A-17	1498NT	A-5, A-28, M-6	2547	L-3
114GMC	T-7	680IG	A-17	1532	T-11	2549	L-3
123P	T-7	681I	A-17	1533	L-2	2601	A-10
123PQC	T-8	690	A-17	1542TRDR	P-17	2603	A-10
125	T-8	690G	A-16	1542TRFBA	P-17	2604	A-10
128	T-8	691	A-16	1542TRFM	P-17	2608	L-3
201	T-5	691TR	A-16	1547	L-2	2621	A-10

INDEX

CAT. NO.	PAGE	CAT. NO.	PAGE	CAT. NO.	PAGE	CAT. NO.	PAGE
2622	A-10	3267WBK	L-8	4015D4F	T-6	5745AN	B-78, G-11
2623	A-10	3300	L-8	4017CC10	T-6	5746AN	B-78, G-11
2624	A-10	3330G	H-26	4063CC10	T-6	5750	B-78
2625	A-10	3330	H-26	4155	T-6	5751AN	B-78, G-11
2626	A-10	3331G	H-26	4510	R-13	5760	B-78
2628	A-10	3331SS	H-26	4511	R-13	5761AN	B-78, G-11
2629	A-10	3333SS	H-26	4512	R-13	5762	B-81
2647	L-3	3334SS	H-26	4515	R-14	5765BK	G-9
2648	L-3	3352F	T-5	4515FS	R-14	5850	B-25
2649	L-3	3393	R-13	4515FSGAS	R-14	5851	B-28
2674	L-3	3393	R-13	4515GAS	R-14	5858	B-28
2675	L-3	3430	H-28	4516	R-14	5862	B-11
2676	L-3	3431G	H-28	4550	H-7	5862A	B-10
2708	L-3	3431SS	H-28	4560	H-7	5864BK	G-9
2747	L-3	3433SS	H-28	46001P	R-12	5866BK	G-9
2748	L-3	3434SS	H-28	4600	R-12	5871	B-27
2749	L-3	3435SS	H-28	4609	R-12	5890	B-23
2774	L-3	3700	R-9	4700	H-6	6098PG	T-4
2775	L-3	3700	R-9	4710	H-6	6207	B-77
2776	L-3	3700FS	R-9	4715SS	H-6	6307	B-77
2847	L-3	3703	R-9	4716SS	H-6	6500	L-7
2848	L-3	3703FS	R-9	4750	H-7	6700	L-7
2849	L-3	3703T	R-9	4760	H-7	6800	L-7
2874	L-3	3703TCW	R-9	4792	H-6	6810	B-81
2875	L-3	3710	R-9	4867Y	G-9	7070PG	T-4
2876	L-3	3710FS	R-9, H-35	48845C5E	T-18	7088	B-81, G-11
2877	L-3	3720	R-9	48845CC6	T-18	7090M	T-4
2947	L-3	3720FS	R-9, H-35	4887Y	G-9	7090MH	T-4
2948	L-3	3722FS	R-9, H-35	5251	B-28	7090PG	T-4
2949	L-3	3723	R-9	5251SSWB	B-28	7101	H-5
2974	L-3	3723FS	R-9	5258	B-28	7102	H-5
2975	L-3	3724FS	R-9	5261	B-27	7210	H-5
2976	L-3	3726SC	R-11	5262	B-23	7251DF	B-78, G-11
2977	L-3	3760	R-11, H-35	5262A	B-10	7310	H-26
3050	L-8	3762	H-32	5262CD	B-22	7311G	H-26
3051BK	L-8	3763	R-11	5262CH	B-22	7311SS	H-26
3052BK	L-8	3763M	H-32	5262SP	F-6, B-72	7311SSBK	H-26
3054BK	L-8	3764	H-33	5276BK	G-9	7313SS	H-26
3055BK	L-8	3765	H-33	5278SS	G-10	7313SSBK	H-26
3056BK	L-8	3769	H-33	5278SSBK	G-10	7379	H-33
3057BK	L-8	3770SC	R-11	5279SS	G-10	7408SS	H-27
3058BK	L-8	3771	H-32	5279SSBK	G-10	7409SS	H-27
3059	L-8	3775	H-33	5296BK	G-9	7410	H-27
3059F	L-8	3777	H-32	5290	B-23	7410G	H-27
3060BK	L-8	3778	R-7	5351	B-28	7411G	H-27
3061BK	L-8	3780	R-11	5352ISP	F-3, F-9, E-32	7411SS	H-27
3090	L-8	3780SC	R-11	5358	B-28	7413G	H-27
3099	L-8	3780SCFBX	R-10	5361	B-27	7413SS	H-27
3099F	L-8	3780SCLV	R-10	5362	B-23	7420	R-13
3200	L-8	3780SCMH	R-10	5362A	B-9, B-10	7425	H-9, H-10, H-14, H-16, H-35, H-36, R-12
3232	B-53	3795	R-9	5362CD	B-22	7427	H-4
3232MH	B-53	3796	R-13	5362CH	B-22	7461CC10	T-9
3232S	B-53	3797	R-13	5362SP	F-6, B-72	7506	H-5
3232TR	B-49	3801	B-78	5371	B-28	7526	H-5
3232TRNA	B-49	3802	B-78	5374BK	G-9	7535	H-5
3232TRS	B-49	3804	B-78	5378SS	G-10	7547DF	H-5
3232TRWR	B-51	3820	B-78	5379SS	G-10	7554SS	H-26
3241BK	L-8	3822	B-78	5406BK	T-2	7555G	H-26
3241WBK	L-8	3830	B-78	5478SS	G-10	7555SS	H-26
3251BK	L-8	3854	B-78	5479SS	G-10	7556SS	H-26
3251WBK	L-8	3860	B-78	5651	B-28	7557SS	H-26
3260BK	L-8	3861	B-78, G-11	5658	B-28	7572G	H-26
3260WBK	L-8	3864	B-78	5662	B-11	7580	H-26
3261BK	L-8	3864NA	B-78	5662A	B-10	7580G	H-26
3261WBK	L-8	3867	G-11	5666BK	G-9	7582	H-26
3262BK	L-8	3869	B-78, G-11	5669BK	G-9	7621	B-81
3262WBK	L-8	3870	B-78	5671	B-27	7764	H-33
3263BK	L-8	3884	B-78	5678SS	G-10	7765	H-33
3263WBK	L-8	3890	B-78	5679SS	G-10	7770	H-32, H-33, H-35, H-36, R-12
3265BK	L-8	3894	B-78	5740	B-78		
3267BK	L-8	3901W	T-3	5741AN	B-78, G-11		

INDEX

CAT. NO.	PAGE	CAT. NO.	PAGE	CAT. NO.	PAGE	CAT. NO.	PAGE
7801P	A-25, M-3	20414	H-30	26861	B-48	52919	J-19
7802MD	A-25, M-3	20414N	H-30	31528	T-5	52920	J-19
7803MD	A-24, A-25, M-2, M-3	20415	H-30	29816C2	T-4	52940	J-19
7806P	A-25, M-3	20415N	H-30	32324	B-53	52942	J-19, J-31
7812EX	A-25, M-3	20416N	H-30	33300	Q-2, Q-6	52943	J-19, J-31
7812PMD	A-25, M-3	20417N	H-30	33303	Q-4, Q-7	52944	J-19, J-31
7813EX	A-25, M-3	20418	H-30	33310	Q-2, Q-6, Q-7	52972	J-19, J-31
7813PMD	A-25, M-3	20443N	H-30	43308	T-6	52982	J-19, J-31
7830	A-25, M-3	20444N	H-30	43379	G-11	52983	J-19, J-31
7832MD	A-25, M-3	20445N	H-30	43399	G-11	52984	J-19, J-31
7833MD	A-25, M-3	20446N	H-30	44400	Q-4, Q-7	53542	J-19, J-31
7842MD	A-26, M-4	21414	H-30	46007P	R-12	53582	J-19, J-31
7843MD	A-26, M-4	21415	H-30	46008P	R-12	53622	J-19, J-31
7860	A-27, M-5	21420	H-30	460026P	R-12	53623	J-19, J-31
7862	A-27, M-5	21426	H-30	48643	T-7	53642	J-19, J-31
7862R	A-27, M-5	21426S	H-30	51920	J-19, J-31	53643	J-19, J-31
7863	A-27, M-5	22200	Q-2, Q-6, Q-7	51940	J-19, J-31	53644	J-19, J-31
7863R	A-27, M-5	23000	H-29	51970	J-19, J-31	53682	J-19, J-31
7958P	H-33, T-4	23000G	H-29	51972	J-19, J-31	53683	J-19, J-31
8002M	T-5	23000HG	H-29	51980	J-19, J-31	53684	J-19, J-31
8052CC10	T-5	23002N	H-29	52022	J-19, J-31	53772	J-19, J-31
8101	T-5	23005N	H-29	52023	J-19, J-31	53773	J-19, J-31
8200	B-7, E-7	23035N	H-29	52029	J-19, J-31	53774	J-19, J-31
8200H	B-13, E-10	23050	H-29	52042	J-19, J-31	53823	J-19, J-31
8200IL	B-7, E-7, F-5	23054N	H-29	52043	J-19, J-31	53824	J-19, J-31
8200SP	B-71, E-30, F-5	23056N	H-29	52044	J-19, J-31	53843	J-19, J-31
8200WMRI	B-8, E-8, B-13	24845C5E	T-18	52073	J-19, J-31	53844	J-19, J-31
8201	B-26, E-13	24845CC6	T-18	52074	J-19, J-31	53879	J-21
8284	B-26, E-13	25250	H-31	52079	J-21	53883	J-19, J-31
8300	B-7, E-7	25414	H-31	52082	J-19, J-31	53884	J-19, J-31
8300H	B-13, E-10	25414N	H-31	52083	J-19, J-31	53889	J-19, J-31
8300IL	B-7, E-7	25415	H-31	52084	J-19, J-31	55015	Q-4, Q-7
8300IMR	B-8, E-8, F-5	25415N	H-31	52172	J-19, J-31	55020	Q-4, Q-7
8300SP	B-71, B-78, E-30, F-5	26242	B-43	52174	J-19, J-31	55025	Q-4, Q-7
8301	B-26, E-13	26252	B-44	52222	J-19, J-31	55500	Q-5
8302AN	G-11, B-78, B-79	26252CD	B-21	52223	J-19, J-31	55501	Q-3, Q-6, Q-7
8384	B-26, E-13	26252CH	B-21	52224	J-19, J-31	55528	Q-4, Q-7
8462N	B-78	26262HG	B-42, E-19	52229	J-19	65501	Q-5, Q-6, Q-7
8601	T-6	26342	B-43	52242	J-19, J-31	65505	Q-5
8678	T-6	26352	B-44	52243	J-19, J-31	65521	Q-3, Q-6, Q-7
8681	T-8	26352CD	B-21	52244	J-19, J-31	67705	Q-5
8694	T-6	26352CH	B-21	52272	J-19, J-31	77700	Q-4, Q-7
8800	B-7, E-7	26362HG	B-42, E-19	52282	J-19, J-31	77702	Q-3, Q-6, Q-7
8801	B-26, E-13	26400	H-30, H-31	52283	J-19, J-31	77705	Q-4, Q-7
9814	T-5	26401	H-30, H-31	52284	J-19, J-31	77706	Q-5, Q-7
9880	T-5	26402	H-30, H-31	52371	J-21	77708	Q-5, Q-6
9977	B-81, G-11	26404	H-30, H-31	52401	J-21	80700	S-35, T-10
10020	T-6	26414	H-30	52402	J-21	83300	Q-2, Q-6, Q-7
10027	T-6	26415	H-30	52421	J-21	85502	Q-3, Q-6
10028	T-6	26415A	H-30	52481	J-21	168950	T-2
10045	T-5	26420	H-30	52501	J-21	385440	B-78
10083M	T-4	26426	H-30	52521	J-21	388440	B-78
10085	T-5	26427	H-30	52581	J-21	941904	T-9
12845C5E89	T-18	26514	H-31	52718	J-19, J-31	1008316	T-4
13053UN	T-3	26514A	H-31	52742	J-19, J-31	1375220	T-11
13057UN	T-3	26515	H-31	52743	J-19, J-31	1475277	T-11
13741	T-9	26515A	H-31	52744	J-19, J-31	2601347	A-10
14629	G-11	26520	H-31	52773	J-19, J-31	2603347	A-10
15010	Q-5, Q-7	26526	H-31	52774	J-19, J-31	2621347	A-10
15040	Q-5, Q-7	26527	H-31	52782	J-19, J-31	2623347	A-10
19062	T-5	26652	B-44	52783	J-19, J-31	2624347	A-10
19980PG	T-4	26661	B-48	52872	J-19, J-31		
20403N	H-30	26852	B-44	52873	J-19, J-31		

designed to be better.™



© 2017 Legrand All Rights Reserved PCA206F 11116



Electrical Wiring Devices

P.O. Box 4822
Syracuse, NY 13221-4822
1.877.BY.LEGRAND (295.3472)
www.legrand.us

570 Applewood Crescent
Vaughan, Ontario L4K 4B4
905.738.9195
www.legrand.ca

